

# I-8014(C)W/I-9014(C) I/O Module User Manual

V 2.0.0 April 2018



Written by Martin Hsu  
Edited by Anna Huang

## Warranty

---

All products manufactured by ICP DAS are under warranty regarding defective materials for a period of one year, beginning from the date of delivery to the original purchaser.

## Warning

---

ICP DAS assumes no liability for any damage resulting from the use of this product. ICP DAS reserves the right to change this manual at any time without notice. The information furnished by ICP DAS is believed to be accurate and reliable. However, no responsibility is assumed by ICP DAS for its use, nor for any infringements of patents or other rights of third parties resulting from its use.

## Copyright

---

Copyright © 2018 by ICP DAS Co., Ltd. All rights are reserved.

## Trademarks

---

Names are used for identification purposes only and may be registered trademarks of their respective companies.

## Contact Us

If you have any problems, please feel free to contact us.  
You can count on us for a quick response.  
Email: [service@icpdas.com](mailto:service@icpdas.com)

# Table of Contents

Table of Contents .....	3
Preface .....	5
1. Introduction .....	6
1.1. Features .....	7
1.2. Specifications .....	9
1.3. Pin Assignments .....	10
1.4. Jumper Settings .....	12
1.5. Wire Connections .....	15
1.6. Block Diagram .....	16
1.7. Demo Programs .....	17
2. Quick Start .....	21
2.1. MiniOS7-based Controllers .....	22
2.1.1. Getting Started.....	23
2.1.2. Calibration.....	25
2.2. Windows-based Controllers.....	35
2.2.1. Getting Started.....	36
2.2.2. Calibration.....	38
3. Magic Scan .....	45
3.1. The Advantages of Magic Scan .....	46
3.1.1. High speed AD with high precision Timer request .....	47
3.1.2. Magic Scan, read AD from 4K AI FIFO .....	48
3.1.3. 4K AI FIFO with FIFO level limit interrupt to reduce the CPU loading greatly .....	49
3.1.4. Application Examples.....	50
3.2. Magic Scan Mode.....	54
3.2.1. Standard Mode .....	55
3.2.2. Virtual Sample and Hold Mode.....	56
3.3. Trigger Methods.....	57
3.3.1. Software Trigger Method.....	58
3.3.2. Internal Hardware Trigger Method.....	59
3.3.3. External Hardware Trigger Method .....	60
3.4. FIFO .....	61
3.5. Magic Scan Procedure .....	62
3.6. Magic Scan Example .....	63
3.6.1. Magic.exe .....	64
3.6.2. Mag_ISR.exe.....	70

3.7.	Case Study.....	71
4.	API References .....	73
4.1.	i8014W_Init .....	75
4.2.	i8014W_GetFirmwareVer_L1 .....	77
4.3.	i8014W_GetFirmwareVer_L2 .....	78
4.4.	i8014W_GetLibVersion .....	79
4.5.	i8014W_GetLibDate.....	80
4.6.	i8014W_GetSingleEndJumper .....	81
4.7.	i8014W_ReadGainOffset .....	83
4.8.	i8014W_Read_mA_GainOffset.....	85
4.9.	i8014W_ReadAI .....	87
4.10.	i8014W_ReadAIHex .....	89
4.11.	i8014W_ConfigMagicScan .....	91
4.12.	i8014W_StartMagicScan.....	94
4.13.	i8014W_StopMagicScan .....	95
4.14.	i8014W_ReadFIFO .....	96
4.15.	i8014W_CalibrateData.....	98
4.16.	i8014W_CalibrateDataHex.....	100
4.17.	i8014W_UnLockFIFO .....	102
4.18.	i8014W_ClearFIFO .....	103
4.19.	i8014W_InstallMagicScanISR.....	104
4.20.	i8014W_UnInstallMagicScanISR .....	107
4.21.	i8014W_ClearInt.....	108
5.	Troubleshooting.....	109
5.1.	How to verify the AI function on a WinCE or WES unit.....	110
5.2.	Service/Request Requirements .....	113
5.3.	What to do when the data read from I-8014W seems unstable.....	114
5.4.	How to solve the FIFO LATCHED error (-6).....	115
	Appendix A. Error Code .....	116
	Appendix B. Revision History .....	117

# Preface

The I-8014(C)/I-9014(C) is a high speed isolated analog input module providing 16 single-ended or 8 differential analog input channels at 16-bit resolution. Besides including basic usage instructions and details of the SDK interface, this manual also introduces the Magic Scan function incorporated in the I-8014W that can be used for scanning multi-channel systems.

The information contained in this manual is divided into the following topics:

- [Chapter 1, “Introduction”](#) – This chapter provides information related to the hardware, such as the specifications, the jumper settings details and wiring information.
- [Chapter 2, “Quick Start”](#) – This chapter provides information on how to get started, an overview of the location of the demo programs, a “Getting Started Guide”, and an outline of the calibration process.
- [Chapter 3, “Magic Scan”](#) – This chapter introduces the attributes related to the Magic Scan function, the programming procedures, and demo programs.
- [Chapter 4, “API References”](#) – This chapter describes the functions provided in the I-8014W library together with an explanation of the differences in the naming rules used for the MiniOS7 and Windows platforms.
- [Chapter 5, “Troubleshooting”](#) – This chapter provides some troubleshooting solutions should you encounter any problems while operating the I-8014W.

# 1. Introduction

The I-8014(C)W/I-9014(C) are high performance analog input modules. I-8014W/I-9014 is up to 16-channel single-ended or 8-channel differential inputs. I-8014CW/I-9014C is up to 8-channel differential inputs. They feature 16-bit resolution, 250Ks/s sampling rates, and 4K-sample FIFO. They provide isolation protection of 2500 VRMS.

The I-8014(C)W/I-9014(C) (Hereinafter referred to as I-8014W) contain an impressive scan function called Magic Scan, which are able to improve many of the functions and meets the demands of high-end users. The Magic Scan mechanism not only scans the different input channels at vastly different rates, but also at different gains.

Even in a multi-channel scan, the sampling rates can be maintained at 250KS/s.

I-8014W contains two types of Magic Scan. One is a standard Scan and the other is a virtual sample and hold function. Almost all AI Cards are expensive if they provide a sample and hold function, but ICP DAS can now provide you with a low-cost alternative.

I-8014W module includes a 4K onboard FIFO buffer for A/D conversion. With the Magic Scan function and 4K FIFO, the I-8014W can easily implement high-speed and time-critical data acquisition applications.

The differences between I-8014W/I-9014 and I-8014CW/I-9014C are as below:

	I-8014W/I-9014	I-8014CW/I-9014C
Input Range	+/- 10 V, +/- 5 V, +/- 2.5 V, +/- 1.25 V and +/- 20 mA	+/- 20 mA only
Select Input Type	Differential or Single-Ended Mode	Differential Mode only
Wire Connection for current measurement	Need external 125 ohm resistor for current measurement	Do not need external 125 ohm resistor for current measurement
Calibration Parameter	8 channels AI using 1 calibration parameter	8 channels AI using independent calibration parameter

## 1.1. Features

### I-8014W/I-9014

- 16 single-ended/8 differential inputs (jumper selectable)
- Input Range : +/- 10V, +/- 5V, +/- 2.5V, +/- 1.25V, +/- 20mA

### I-8014CW/I-9014C

- 8 differential inputs
- Input Range : +/- 20mA
- 16-bit 250KHz ADC converter
- 4K-samples FIFO buffer
- External trigger mode : post-trigge
- Internal/external trigger start
- Magic Scan Type

### Type 1: General

Each Sample clock only samples a single.

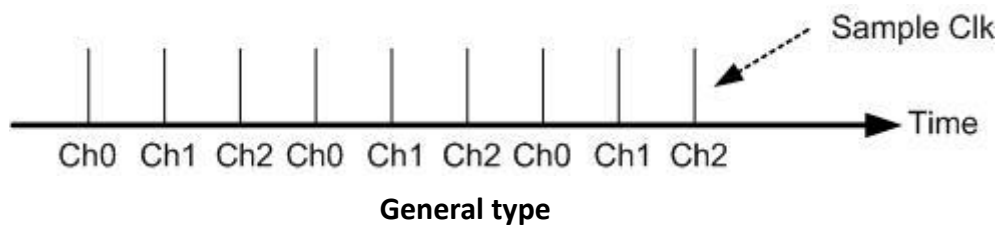

When set as Standard mode,

1. The maximum sample rate can set as 250 KHz.
2. If scan multi channels, the sample rate for each channel will be  $(\text{Sample Rate})/(\text{channel count})$

For example, if set sample rate as 250 KHz and scan 2 channels, the sample rate for each channel is 125 KHz.

Sample channel count	Hz/Ch
1	250KHz
2	125KHz
3	83.3KHz
4	62.5KHz

## Type 2: virtual Sample and hold

Each sample clock will to sample all scan channels that have been set.

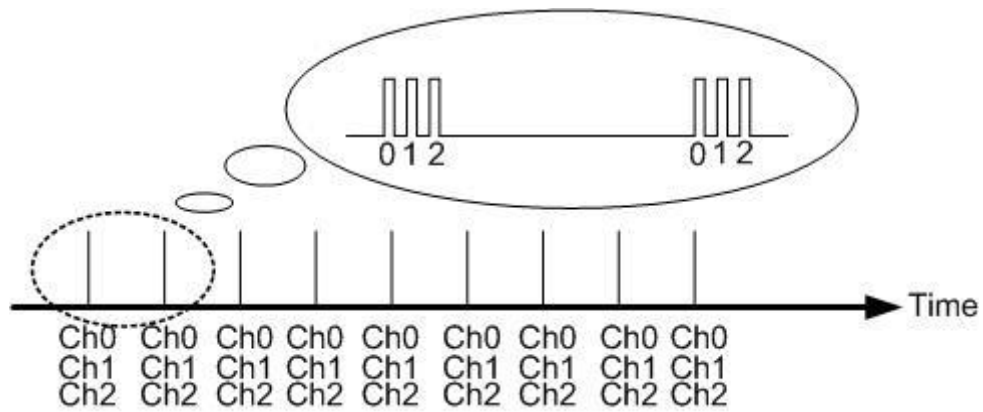

**Virtual Sample and hold type**

When set as Virtual Sample and Hold mode,

1. The maximum sample rate is 125 KHz.
2. It use 250 KHz (4 us) internal sample clock to scan each channel.
3. All channels are the sample rate.
4. The total sample rate for all channel must  $\leq$  125 KHz

Scanned Ch Count	Hz/Ch	Total Sample Rate
1	125KHz	125KHz
2	62.5KHz	125KHz
4	31.25 KHz	125 KHz



## 1.2. Specifications

Model	I-8014W/I-9014	I-8014CW/I-9014C
<b>Analog Output</b>		
Channels	8-ch Differential/16-Single-ended	8-ch Differential
Voltage Input Range	±1.25, ±2.5, ±5 V, ±10 V	-
Current Input Range	-20 mA ~ +20 mA(Requires Optional External 125 Ω Resistor)	-20 mA ~ +20 mA
Resolution	16-bit	
Sample Rate	Single Channel Polling Mode :250K S/s	
FIFO	4 k Words	
Accuracy	0.05% of FSR	
Input Mode	Polling, Pacer (Magic Scan)	
Magic Scan Mode	Mode 1: Standard Mode Mode 2: Virtual Sample and Hold	
Overvoltage Protection	-45 V ~ +60 V	
Input Impedance	20 K, 200 K, 20 M (Jumper Select)	125 Ω
<b>LED Indicators</b>		
Power LED Indicator	Yes	
<b>Isolation</b>		
Intra-module Isolation, Field-to-Logic	2500 Vrms	
<b>Power</b>		
Power Consumption	2.5 W Max.	
<b>Mechanical</b>		
Dimension (L x W x H)	For I-8014(C)W: 102 mm x 30 mm x 115 mm For I-9014(C): 144 mm x 31 mm x 134 mm	
<b>Environment</b>		
Operating Temperature	-25 °C ~ +75°C	
Storage Temperature	For I-8014(C)W: -30 °C ~ +85°C For I-9014(C): -40°C ~ +85°C	
Humidity	10 % ~ 90% RH, non-condensing	

### 1.3. Pin Assignments



I-9014					
Pin Assignment	Terminal No.		Pin Assignment		
Trig+	01			02	Trig-
V0+	03			04	V0-
V1+	05			06	V1-
V2+	07			08	V2-
V3+	09			10	V3-
V4+	11			12	V4-
V5+	13			14	V5-
V6+	15			16	V6-
V7+	17			18	V7-
AGND	19			20	F.G.



I-9014C					
Pin Assignment	Terminal No.		Pin Assignment		
Trig+	01			02	Trig-
I0+	03			04	I0-
I1+	05			06	I1-
I2+	07			08	I2-
I3+	09			10	I3-
I4+	11			12	I4-
I5+	13			14	I5-
I6+	15			16	I6-
I7+	17			18	I7-
AGND	19			20	F.G.

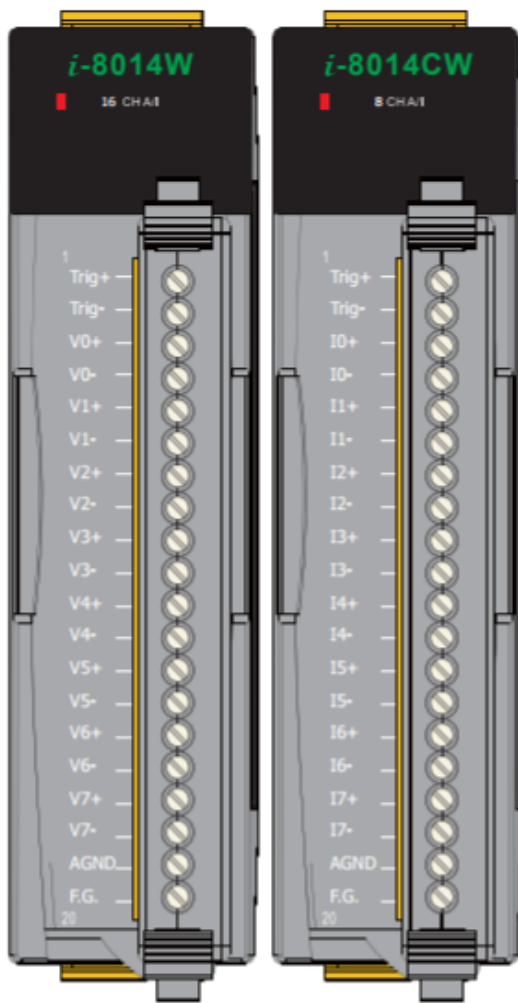

Terminal No.	Pin Assignment	
	I-8014W	I-8014CW
01	Trig+	Trig+
02	Trig-	Trig-
03	V0+	I0+
04	V0-	I0-
05	V1+	I1+
06	V1-	I1-
07	V2+	I2+
08	V2-	I2-
09	V3+	I3+
10	V3-	I3-
11	V4+	I4+
12	V4-	I4-
13	V5+	I5+
14	V5-	I5-
15	V6+	I6+
16	V6-	I6-
17	V7+	I7+
18	V7-	I7-
19	AGND	AGND
20	F.G.	F.G.

# 1.4. Jumper Settings

## I-8014W/I-8014CW

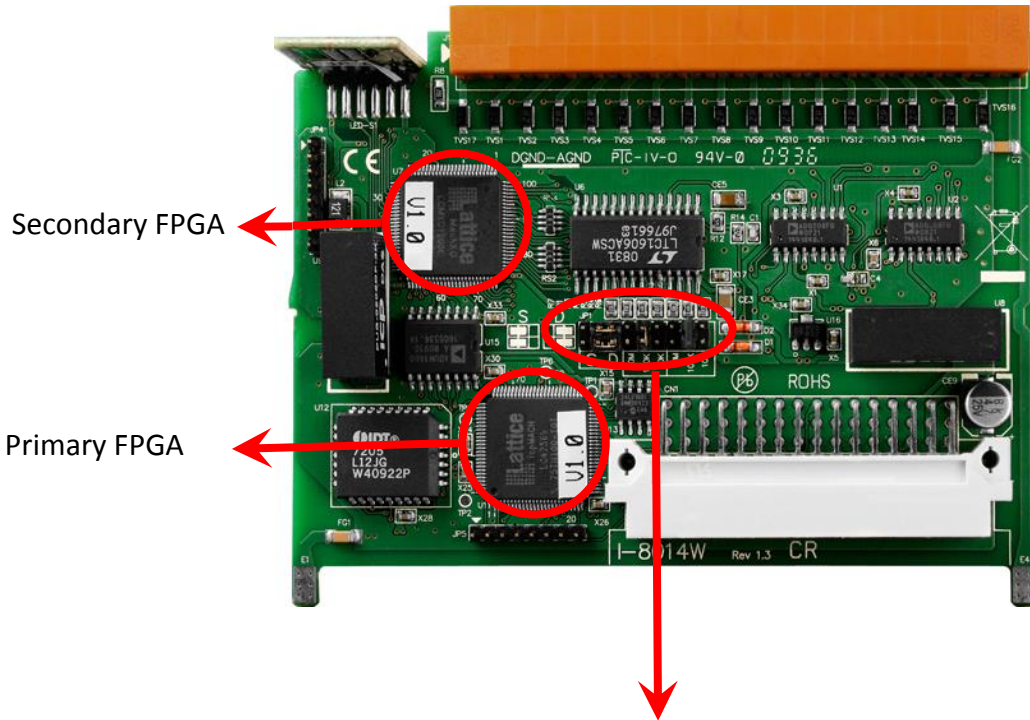

### Differential / Single-ended Jumper Selection

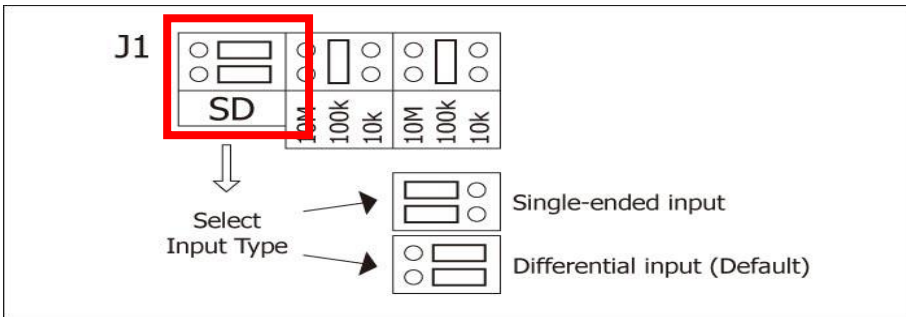

### Input impedance Jumper Selection

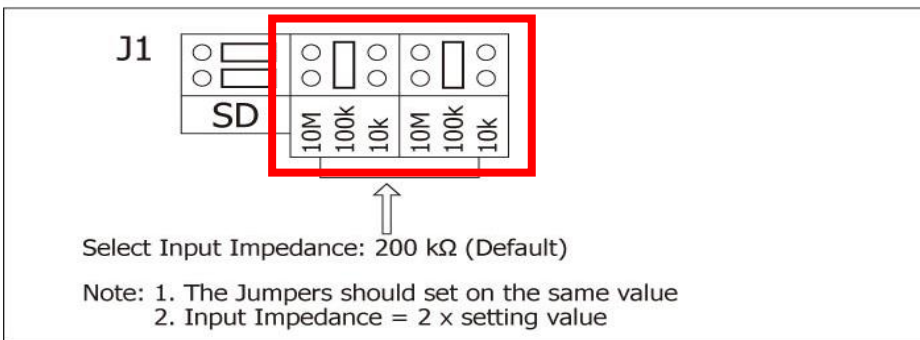

Note : I-8014CW do not have those Jumper, it is only with Differential Mode and Input impedance 20 KΩ

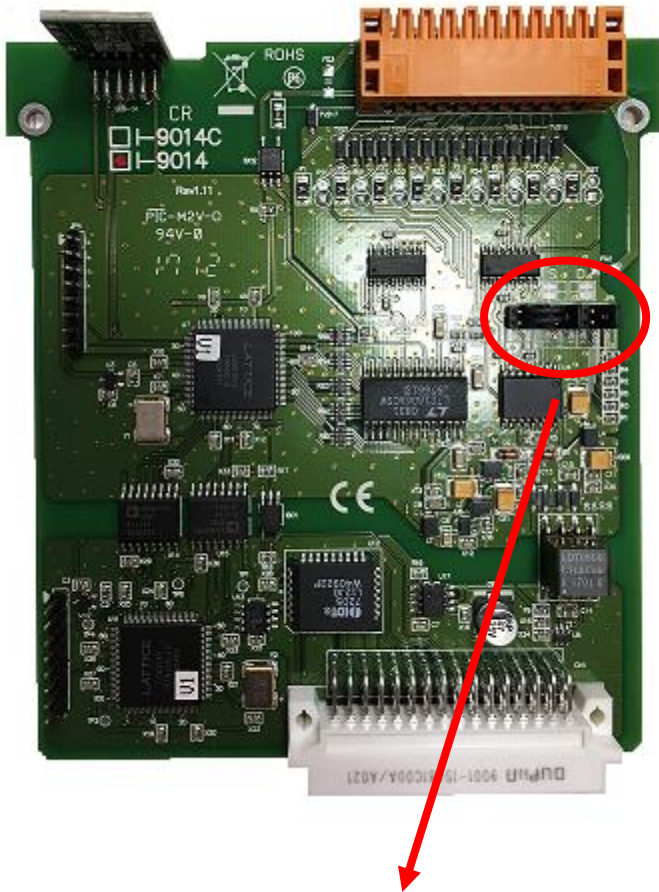

### Differential / Single-ended Jumper Selection

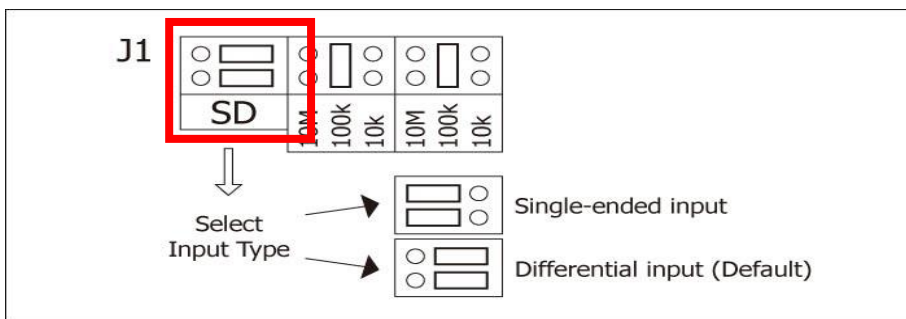

### Input impedance Jumper Selection

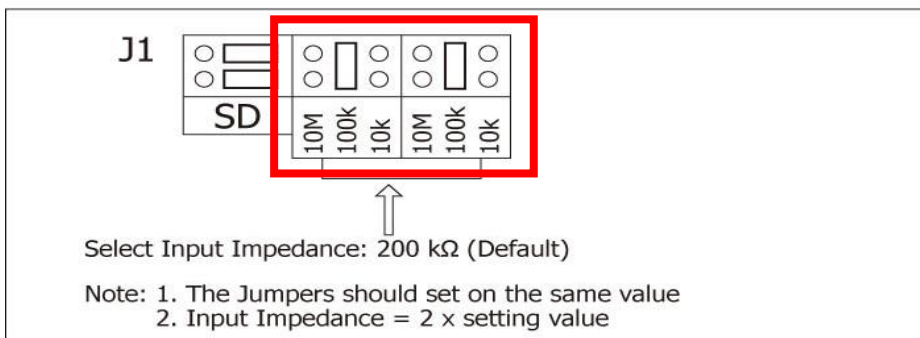

Note : I-9014C do not have those Jumper, it is only with Differential Mode and Input impedance 20 KΩ

## Adjusting the Input impedance

The I-8014W allows three input impedance options, including 20 k $\Omega$ , 200 k $\Omega$  (default setting) and 20 M $\Omega$  to meet system requirements. In most cases, 200 k $\Omega$  is sufficient.

Note that each time the input impedance is adjusted on a calibrated module, the module must be recalibrated. Refer to the Calibration section on page 19 if you are using an I-8000 or iPAC-8000 (MiniOS7 platform controller), or refer to page 32 for details of the calibration process if you are using a module based on the WinCE or WES platform.

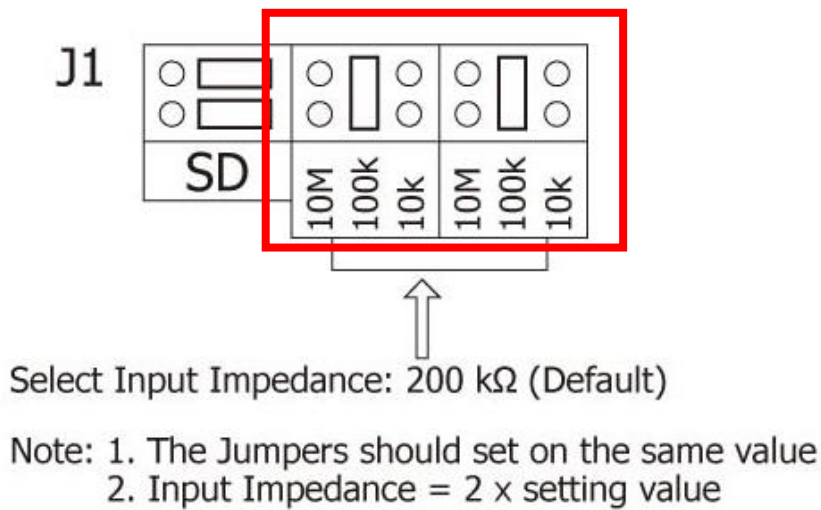

## 1.5. Wire Connections

### I-8014W/I-9014

	Voltage Input Wiring	Current Input Wiring
Differential		
Single-ended		

### I-8014CW/I-9014C

	Current Input Wiring
Differential	

## 1.6. Block Diagram

### I-8014W/I-9014

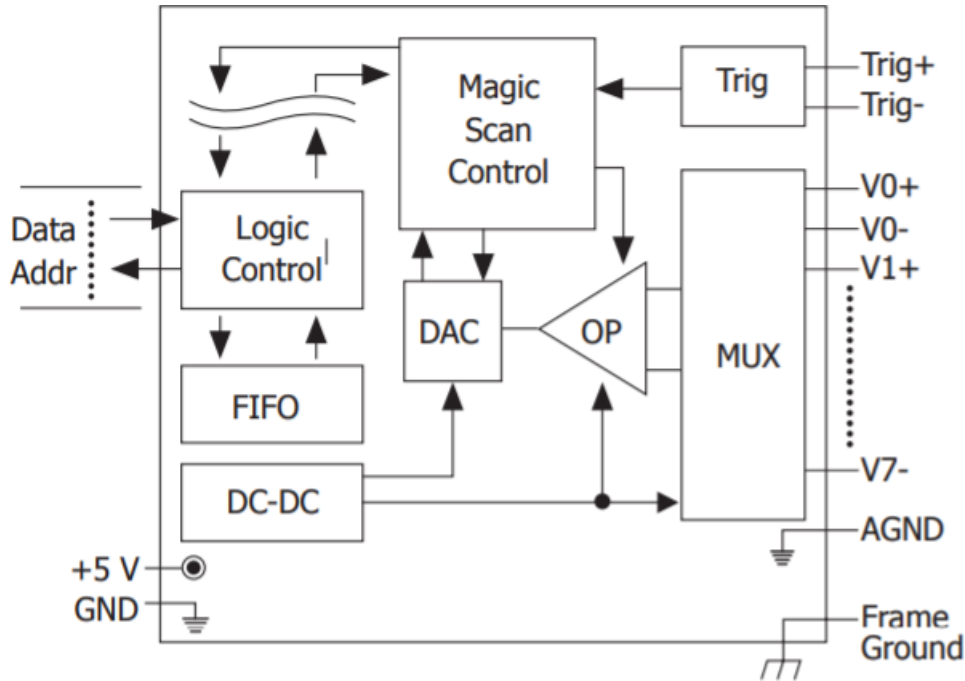

### I-8014CW/I-9014C

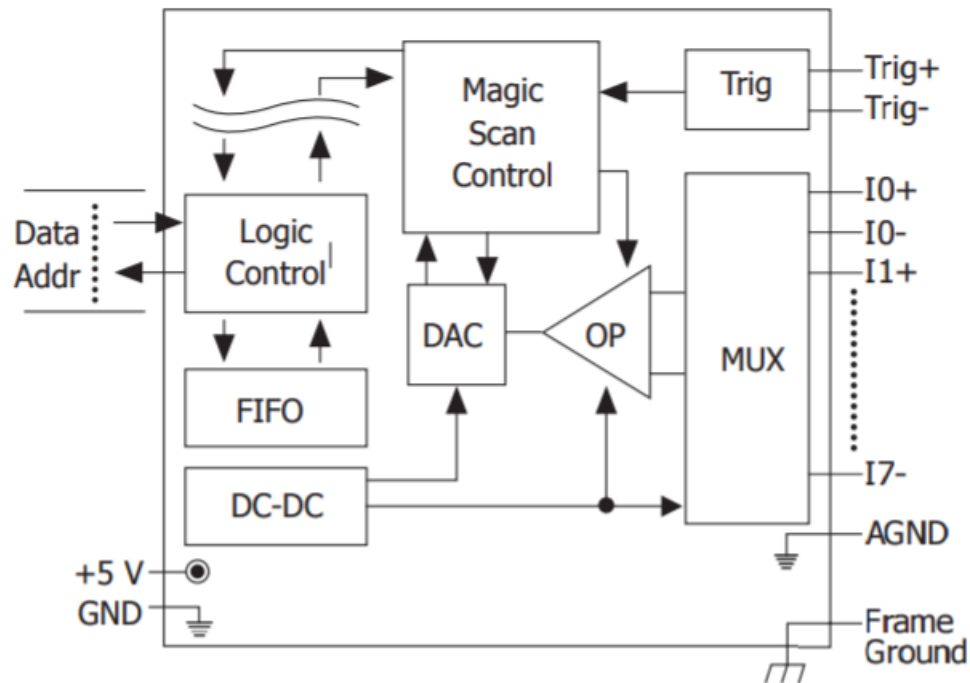



## 1.7. Demo Programs

ICP DAS provides a range of demo programs for different platforms that can be used to verify the functions of the I-8014W. The source code contained in these programs can also be reused in your own custom programs if needed. The following is a list of the locations where both the demo programs and associated libraries can be found on either the ICP DAS web site or the enclosed CD.

Both I-8014W and I-8014CW use the same library, but demo. The I-8014W demo is located at 8014w folder and I-8014CW is located at 8014cw folder.

For example:

I-8014W demo for I-8000 is located at

[ftp://ftp.icpdas.com/pub/cd/8000cd/napdos/8000/841x881x/demo/io\\_in\\_slot/8014w/](ftp://ftp.icpdas.com/pub/cd/8000cd/napdos/8000/841x881x/demo/io_in_slot/8014w/)

I-8014CW demo for I-8000 is located at

[ftp://ftp.icpdas.com/pub/cd/8000cd/napdos/8000/841x881x/demo/io\\_in\\_slot/8014cw/](ftp://ftp.icpdas.com/pub/cd/8000cd/napdos/8000/841x881x/demo/io_in_slot/8014cw/)

Platform	Location
<b>For I-8000</b>	
Library	CD:\Napdos\8000\841x881x\demo\Lib or <a href="ftp://ftp.icpdas.com/pub/cd/8000cd/napdos/8000/841x881x/demo/lib/">ftp://ftp.icpdas.com/pub/cd/8000cd/napdos/8000/841x881x/demo/lib/</a>
Demo	CD:\Napdos\8000\841x881x\demo\IO_in_Slot or <a href="ftp://ftp.icpdas.com/pub/cd/8000cd/napdos/8000/841x881x/demo/io_in_slot/">ftp://ftp.icpdas.com/pub/cd/8000cd/napdos/8000/841x881x/demo/io_in_slot/</a>
<b>For iPAC-8000</b>	
Library	CD:\Napdos\iPAC8000\Demo\Basic\iP-84x1_iP-88x1\Lib or <a href="ftp://ftp.icpdas.com/pub/cd/8000cd/napdos/ipac8000/demo/basic/ip-84x1_ip-88x1/lib/">ftp://ftp.icpdas.com/pub/cd/8000cd/napdos/ipac8000/demo/basic/ip-84x1_ip-88x1/lib/</a>
Demo	CD:\Napdos\iPAC8000\Demo\Basic\iP-84x1_iP-88x1\IO_in_Slot or <a href="ftp://ftp.icpdas.com/pub/cd/8000cd/napdos/ipac8000/demo/basic/ip-84x1_ip-88x1/io_in_slot/">ftp://ftp.icpdas.com/pub/cd/8000cd/napdos/ipac8000/demo/basic/ip-84x1_ip-88x1/io_in_slot/</a>

Platform	Location
<b>For Windows CE5</b>	
Library	CD:\ napdos\wp-8x4x_ce50\SDK\IO_Modules or <a href="ftp://ftp.icpdas.com/pub/cd/winpac/napdos/wp-8x4x_ce50/sdk/io_modules/">ftp://ftp.icpdas.com/pub/cd/winpac/napdos/wp-8x4x_ce50/sdk/io_modules/</a>
Demo	eVC Demo: CD:\napdos\ wp-8x4x_ce50\Demo\WinPAC\eVC\IO\Local or <a href="ftp://ftp.icpdas.com/pub/cd/winpac/napdos/wp-8x4x_ce50/demo/winpac/evc/io/local/">ftp://ftp.icpdas.com/pub/cd/winpac/napdos/wp-8x4x_ce50/demo/winpac/evc/io/local/</a> C# Demo: CD:\napdos\ wp-8x4x_ce50\Demo\WinPAC\C#\IO\Local or <a href="ftp://ftp.icpdas.com/pub/cd/winpac/napdos/wp-8x4x_ce50/demo/winpac/c%23/io/local/">ftp://ftp.icpdas.com/pub/cd/winpac/napdos/wp-8x4x_ce50/demo/winpac/c%23/io/local/</a>
<b>For XP-8000-CE6</b>	
Library	CD:\ SDK\Special_IO <a href="ftp://ftp.icpdas.com/pub/cd/xp-8000-ce6/sdk/special_io/">ftp://ftp.icpdas.com/pub/cd/xp-8000-ce6/sdk/special_io/</a>
Demo	VC2005 Demo: CD:\ demo\XPAC\VC2005\IO\Local <a href="ftp://ftp.icpdas.com/pub/cd/xp-8000-ce6/demo/xpac/vc2005/io/local/">ftp://ftp.icpdas.com/pub/cd/xp-8000-ce6/demo/xpac/vc2005/io/local/</a> C# Demo: CD:\ demo\XPAC\C#\IO\Local <a href="ftp://ftp.icpdas.com/pub/cd/xp-8000-ce6/demo/xpac/c%23/io/local/">ftp://ftp.icpdas.com/pub/cd/xp-8000-ce6/demo/xpac/c%23/io/local/</a>
<b>For XP-8000-Atom-CE6</b>	
Library	CD:\ SDK\Special_IO <a href="ftp://ftp.icpdas.com/pub/cd/xpac-atom-ce6/sdk/special_io/">ftp://ftp.icpdas.com/pub/cd/xpac-atom-ce6/sdk/special_io/</a>
Demo	VC 2005 Demo: CD:\ demo\XPAC\VC2005\IO\Local <a href="ftp://ftp.icpdas.com/pub/cd/xpac-atom-ce6/demo/xpac/vc2005/io/local/">ftp://ftp.icpdas.com/pub/cd/xpac-atom-ce6/demo/xpac/vc2005/io/local/</a> C# Demo: CD:\ demo\XPAC\C#\IO\Local <a href="ftp://ftp.icpdas.com/pub/cd/xpac-atom-ce6/demo/xpac/c%23/io/local/">ftp://ftp.icpdas.com/pub/cd/xpac-atom-ce6/demo/xpac/c%23/io/local/</a>

Platform	Location
<b>For XP-8000</b>	
Library	CD:\SDK\IO <a href="ftp://ftp.icpdas.com/pub/cd/xp-8000/sdk/io/">ftp://ftp.icpdas.com/pub/cd/xp-8000/sdk/io/</a>
Demo	VC Demo: CD:\Demo\pacsdk\vc\IO\Local <a href="ftp://ftp.icpdas.com/pub/cd/xp-8000/demo/pacsdk/vc/io/local/">ftp://ftp.icpdas.com/pub/cd/xp-8000/demo/pacsdk/vc/io/local/</a> C# Demo: CD:\ Demo\pacsdk\csharp.net\IO\Local\windows_forms <a href="ftp://ftp.icpdas.com/pub/cd/xp-8000/demo/pacsdk/csharp.net/io/local/windows_forms/">ftp://ftp.icpdas.com/pub/cd/xp-8000/demo/pacsdk/csharp.net/io/local/windows_forms/</a>
<b>For XP-Atom</b>	
Library	CD:\ SDK\IO <a href="ftp://ftp.icpdas.com/pub/cd/xpac-atom/sdk/io/">ftp://ftp.icpdas.com/pub/cd/xpac-atom/sdk/io/</a>
Demo	VC Demo: CD:\Demo\pacsdk\vc\IO\Local <a href="ftp://ftp.icpdas.com/pub/cd/xp-8000/demo/pacsdk/vc/io/local/">ftp://ftp.icpdas.com/pub/cd/xp-8000/demo/pacsdk/vc/io/local/</a> C# Demo: CD:\ Demo\pacsdk\csharp.net\IO\Local\windows_forms <a href="ftp://ftp.icpdas.com/pub/cd/xpac-atom/demo/pacsdk/csharp.net/io/local/windows_forms/">ftp://ftp.icpdas.com/pub/cd/xpac-atom/demo/pacsdk/csharp.net/io/local/windows_forms/</a>
<b>For WP-9000</b>	
Library	CD:\WinPAC_AM335x\wp-9000\SDK\IO_Modules <a href="ftp://ftp.icpdas.com/pub/cd/winpac_am335x/wp-9000/sdk/io_modules/">ftp://ftp.icpdas.com/pub/cd/winpac_am335x/wp-9000/sdk/io_modules/</a>
Demo	VC2008 Demo: CD:\WinPAC_AM335x\wp-9000\demo\PAC\Vc2008\IO\Local <a href="ftp://ftp.icpdas.com/pub/cd/winpac_am335x/wp-9000/demo/pac/vc2008/io/loca">ftp://ftp.icpdas.com/pub/cd/winpac_am335x/wp-9000/demo/pac/vc2008/io/loca</a> l/ C# Demo: CD:\WinPAC_AM335x\wp-9000\demo\PAC\C#\IO\Local <a href="ftp://ftp.icpdas.com/pub/cd/winpac_am335x/wp-9000/demo/pac/c%23/io/local/">ftp://ftp.icpdas.com/pub/cd/winpac_am335x/wp-9000/demo/pac/c%23/io/local/</a>

Platform	Location
<b>For IPPC-WES7</b>	
Library	CD:\ippc-wes7\sdk\IO <a href="ftp://ftp.icpdas.com/pub/cd/ippc-wes7/sdk/io/">ftp://ftp.icpdas.com/pub/cd/ippc-wes7/sdk/io/</a>
Demo	VC Demo: CD:\ippc-wes7\demo\pacsdk\vc\io\local\io-9k <a href="ftp://ftp.icpdas.com/pub/cd/ippc-wes7/demo/pacsdk/vc/io/local/io-9k/">ftp://ftp.icpdas.com/pub/cd/ippc-wes7/demo/pacsdk/vc/io/local/io-9k/</a> C# Demo: CD:\ippc-wes7\demo\pacsdk\csharp.net\io\local\io-9k <a href="ftp://ftp.icpdas.com/pub/cd/ippc-wes7/demo/pacsdk/csharp.net/io/local/io-9k/">ftp://ftp.icpdas.com/pub/cd/ippc-wes7/demo/pacsdk/csharp.net/io/local/io-9k/</a>

## 2. Quick Start

This section provides a Getting Started guide and details of the calibration process when using the I-8014W module on either the MiniOS7 or Windows platforms.

This section contains a Getting Started guide and details of the calibration process when using the I-8014W:

- For MiniOS7-based Controllers, see section 2.1 (i-8000 and iPAC-8000 modules)
- For Windows-based Controllers, see section 2.2 (WinCE and WES modules)

## 2.1. MiniOS7-based Controllers

This section contains:

- Getting Started, see section 2.1.1
- Calibration, see section 2.1.2

## 2.1.1. Getting Started

The AI\_INFO.EXE executable file, which is located in the basic\_info folder of the I-8014W demo programs, can be used to retrieve the basic configuration information related to the I-8014W and to verify the AI read functions. The basic configuration information includes:

- The Version number and the published date of the library.
- The FPGA version
- The single-ended/differential jumper settings
- The gain and offset values for each input range
- The data read on each channel

(See the Location of the Demo Programs section on page 12 for details of where to find the AI\_INFO.EXE in the I-8014W demo programs folder)

Step 1. Refer to the Jumper Settings section on page 8. Ensure that the Differential/Single-ended selection jumper is in the differential position.

Step 2. Step 2. Connect a stable signal source (e.g., a battery output) to the I-8014W using the differential wiring method, as illustrated below.

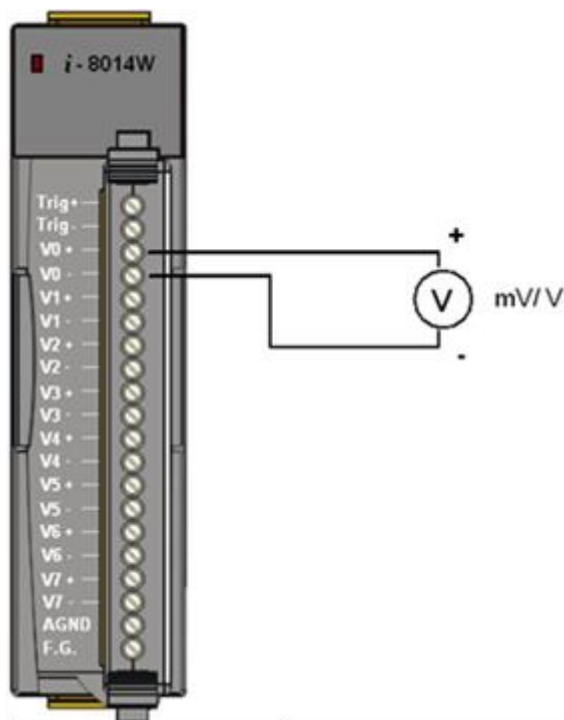

Step 3. Connect the power supply to the unit, and connect the control unit to the Host PC using an RS-232 cable.

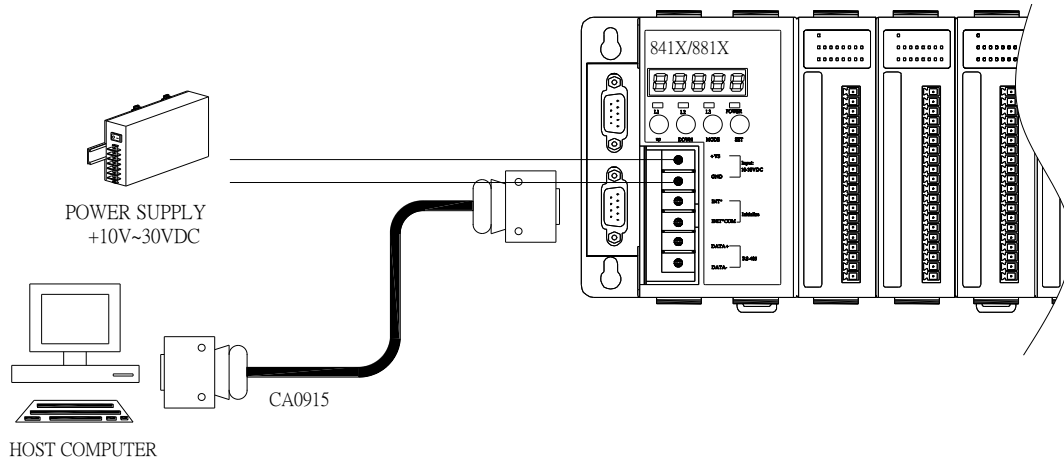

Step 4. Launch the AI\_INFO.EXE executable on the Host PC, and then verify that the basic information and the AI data from each channel is correct, as indicated in the diagram below:

### Tips & Warnings



Unused channels should be connected to GND to avoid floating.

```

This demo show how to use i8014W_ReadAI to read hex and float format analog input data.
There is an i8014 at slot 0
*****
Primary FPGA Version =: 0001
Secondary FPGA Version =: 0002
Library Version =: 1005
Build Date =: Jul 20 2010
*****
i8014W Input Mode=Differential
      Select 0 : +/-10U
      Select 1 : +/-5U
      Select 2 : +/-2.5U
      Select 3 : +/-1.25U
      Select 4 : +/-20mA
Select Gain <0~4>:0
Select Gain[0]=+/-10U ,the Calibrated Gain= 3283
[00]=[2.6645]
[01]=[2.6642]
[02]=[2.6639]
[03]=[2.6639]
[04]=[2.6642]
[05]=[2.6639]
[06]=[2.6642]
[07]=[2.6642]

```

The Library and FPGA version information  
The single-ended/differential jumper position.

The gain value is around 33000. If this value varies significantly from 33000, it means that the value is incorrect.

Verify the AI data from each channel.

Note: I-8014CW only can select max 8 channels and +/- 20 mA Input Range



## 2.1.2. Calibration

Each I-8014W module is factory calibrated and well verified before shipment, so it is usually unnecessary to calibrate the module again, unless the input impedance is changed on a calibrated module or the accuracy is lost.

To calibrate the I-8014W, in addition to inserting the I-8014W into a controller slot, the following items are required:

- A single stable calibration source, such as a 3 1/2 digit power supply (or better) or a battery output.
- A single 4 1/2 digit voltage meter (15-bit resolution or better)
- A Calibration Program. See page 12 for the Location of the Demo Programs contained in the I-8014W demo programs folder.

---

### Tips & Warnings



1. An unstable calibration source will cause calibration errors and will affect the accuracy of the data acquisition.
  2. If you wish to perform calibration using  $\pm 20$  mA, select  $\pm 2.5$  V instead as both types use the same gain and offset values.
  3. The calibration program uses channel 0 to accept the calibration source only.
- 

This section contains:

- Calibrating the I-8014W on i-8000 and iPAC-8000, see section 2.1.2.1
- Verifying the Calibration, see section 2.1.2.2
- Restoring the Default Calibration Settings, see section 2.1.2.3

### 2.1.2.1. Calibrating the I-8014W on i-8000 and iPAC-8000

Step 1. Repeat Steps 1 to 3 as described in the Quick Start guide on page 14.

- a. Attach the power supply to the control unit and then connect the control unit to the Host PC.
- b. Set the Differential/Single-ended jumper to the differential position and connect the calibration source to channel 0 using the differential wiring method.
- c. Connect the meter, as illustrated in the following figure.
- d. Turn on the control unit.

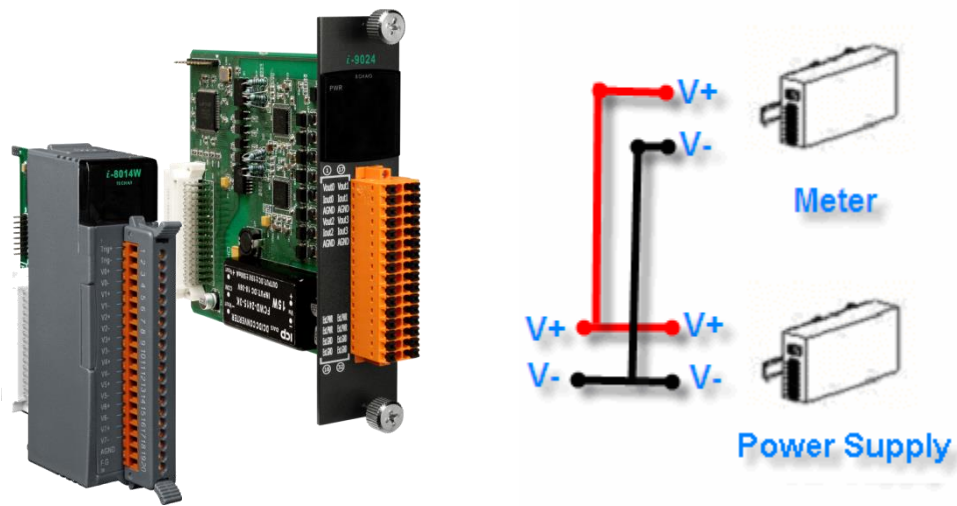

Step 2. Launch the MiniOS7 Utility on the Host PC. Upload the calibration program to the control unit and execute it.

The MiniOS7 Utility can be downloaded from the web site shown below. Select the appropriate calibration program for your controller.

- MiniOS7 Utility: <http://www.icpdas.com/download/minios7.htm>
- 8014cal.exe: This is the calibration program for I-8000 units, which is located in the same folder as the I-8014W demo programs. (See the Location of the Demo Programs section on page 12)
- iP\_8014cal.exe: This is the calibration program for iP-8000 units, which is located in the same folder as the I-8014W demo programs. (See the Location of the Demo Programs section on page 12)

a. Launch the MiniOS7 Utility on the Host PC, and then choose New connection from the Connection menu, or press F2.



b. From the drop-down list, select the COM port for the Host PC that is connected to the control unit, configure the communication parameters to match those indicated below, and then click the OK button.

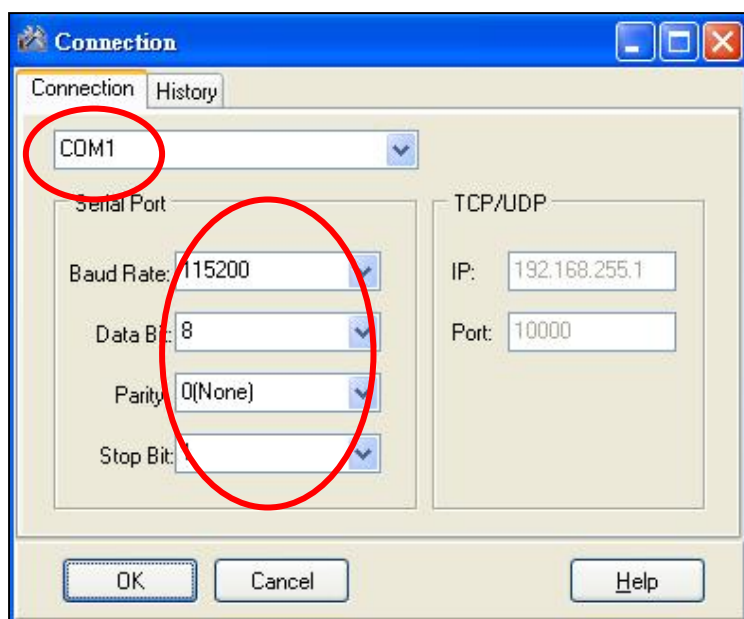

- c. Select the name of the calibration program and then click the Upload button (or press F5) to upload the program to the I-8014 serial module.

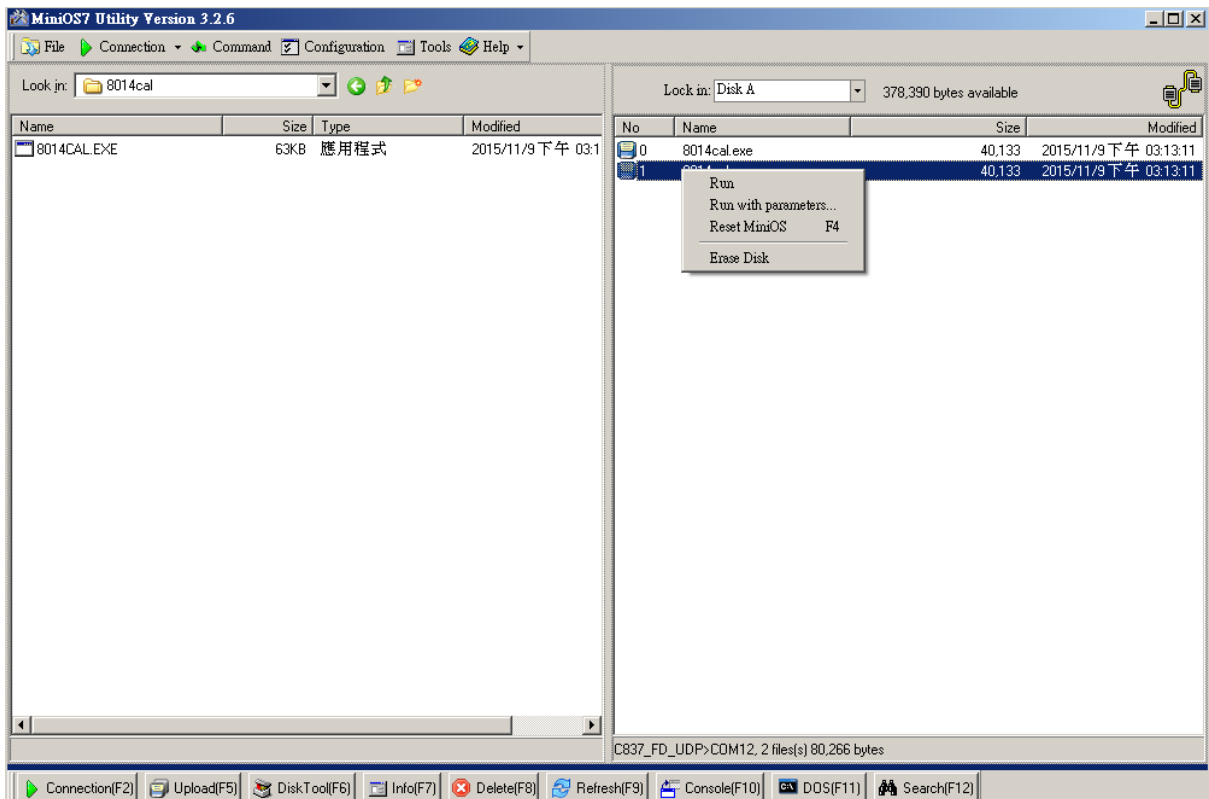
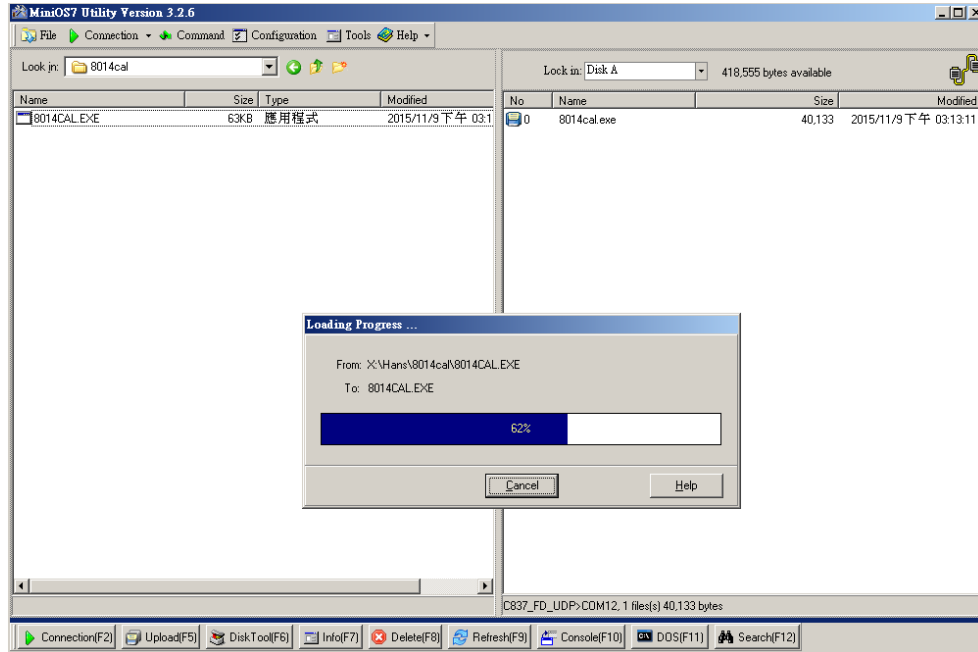

- d. Once the file has been uploaded, right-click the name of the updated calibration file and choose Run.

The calibration program will be executed on the control unit and 7188xw.exe will be executed on the Host PC to provide a command line interface.

Calibration for I-8014W as below :

```
7188XW 1.31 [COM12:115200,N,8,1],FC=0,CTS=1, DIR=X:\Hans\8014cal
C837_FD_UDP>run #2
8014 Found in slot7
*****
* Calibration program for 8014W *
* *
* First CPLD Lattice Firmware Version = 17 *
* Second CPLD Lattice Firmware Version = 2 *
* Please connect a voltage signal *
* to ch0 of the 8014W first. *
* ver 1.0.1 _ Oct 21 2011 by Martin *
*****
*****
* (0)Calibrate Gain_0 -10.00U to +10.00U *
* (1)Calibrate Gain_1 - 5.00U to + 5.00U *
* (2)Calibrate Gain_2 - 2.50U to + 2.50U *
* (3)Calibrate Gain_3 - 1.25U to + 1.25U *
* (r)Recover default calibration settings *
* (t)Read calibrated AI value of Ch0 *
* (s)Show calibrated Gain/Offset parameters *
* (q)quit *
*****
Please choose (0~3,r,t,s,q):
```

Calibration for I-8014CW as below :

```
7188XW 1.31 [COM12:115200,N,8,1],FC=0,CTS=1, DIR=X:\Hans\8014cal
8014 Not in Slot 1
8014 Not in Slot 2
8014 Not in Slot 3
8014 Not in Slot 4
8014 Not in Slot 5
8014 Not in Slot 6
8014 Found in slot7
*****
* Calibration program for 8014CW *
* *
* First CPLD Lattice Firmware Version = 1 *
* Second CPLD Lattice Firmware Version = 2 *
* Please connect a voltage signal *
* to ch0 of the 8014CW first. *
* ver 1.0.2 _ Nov 06 2015 by Hans *
*****
*****
* (4)Calibrate Gain_4 - 20 mA to + 20 mA *
* (r)Recover default calibration settings *
* (t)Read calibrated AI value of Ch0 *
* (s)Show calibrated Gain/Offset parameters *
* (q)quit *
*****
Please choose (0~3,r,t,s,q):
```

Note: I-8014CW only can select +/- 20 mA Input Range

Step 3. Calibrate the I-8014 serial module using the following procedure.

- a. Select the required input type by typing an option from 0 to 3, and then press Enter.

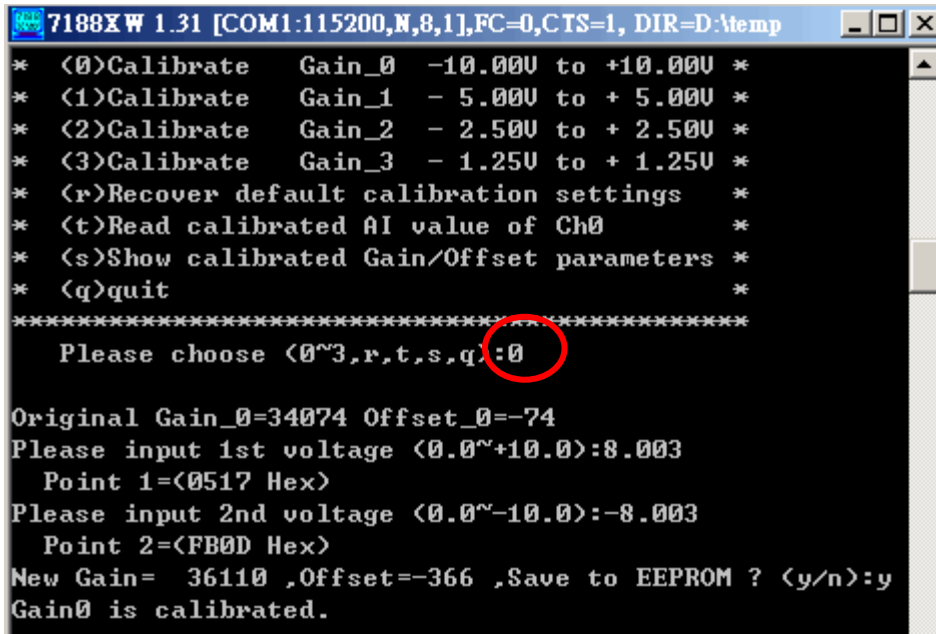

- b. Determine two values (points) within the range of the input type selected for the calibration process.

For example, after selecting option 0 (-10 V - +10 V), +8 V and -8 V can be used as the two calibration points.

- c. Set the calibration source output to one of the two points (e.g., 8 V in this example)



- d. At the input 1st voltage prompt on the console, type the value displayed on the meter and then press Enter.

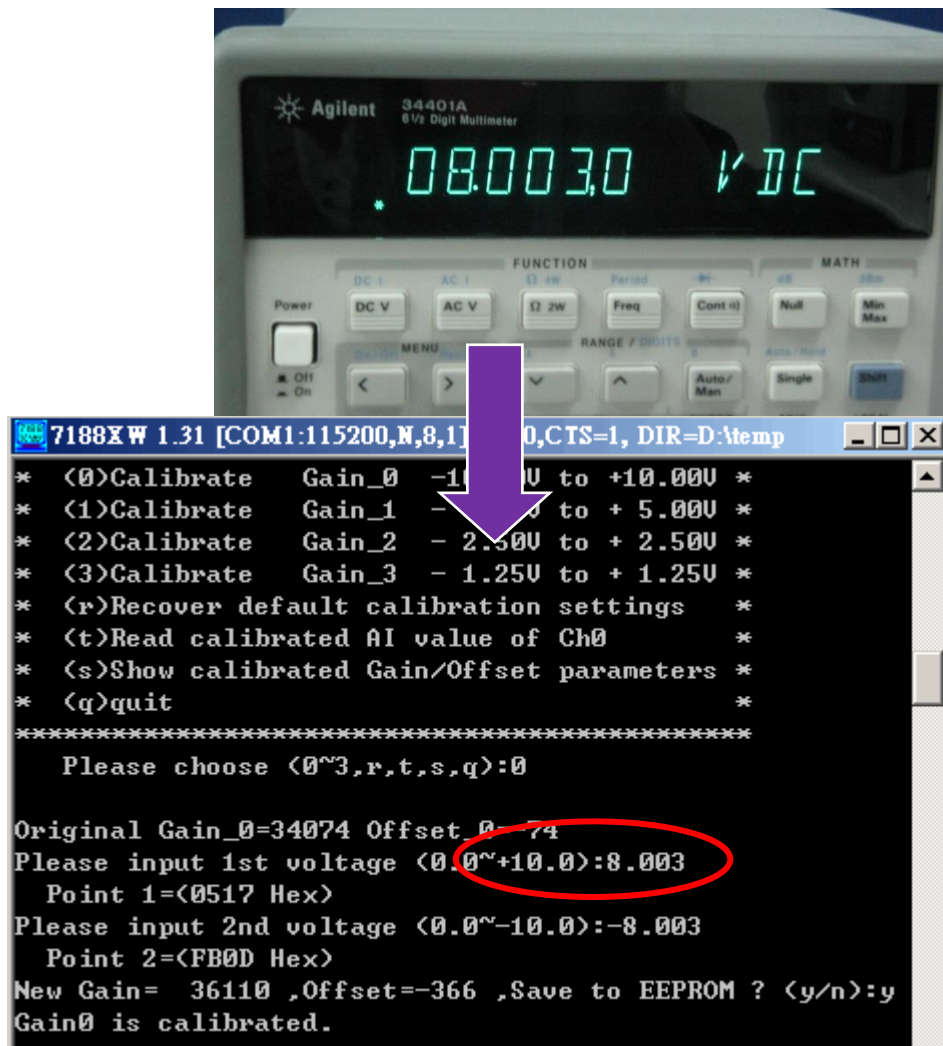

- e. Set the calibration source output to the other point (e.g., - 8 V in this example).

- f. At the input 2nd voltage prompt, type the value displayed on the meter and then press Enter

```
7188XW 1.31 [COM1:115200,N,8,1],FC=0,CTS=1, DIR=D:\temp
* (0)Calibrate Gain_0 -10.000 to +10.000 *
* (1)Calibrate Gain_1 - 5.000 to + 5.000 *
* (2)Calibrate Gain_2 - 2.500 to + 2.500 *
* (3)Calibrate Gain_3 - 1.250 to + 1.250 *
* (r)Recover default calibration settings *
* (t)Read calibrated AI value of Ch0 *
* (s)Show calibrated Gain/Offset parameters *
* (q)quit *
*****
Please choose (0~3,r,t,s,q):0

Original Gain_0=34074 Offset_0=-74
Please input 1st voltage (0.0~+10.0):8.003
Point 1=(0517 Hex)
Please input 2nd voltage (0.0~-10.0):-8.003
Point 2=(FB0D Hex)
New Gain= 36110 ,Offset=-366 ,Save to EEPROM? (y/n):y
Gain0 is calibrated.
```

The new gain and offset values for this calibration will then be displayed on the console as:New Gain= 3xxxx, Offset= nnn, Save to EEPROM? (y/n):

- g. Type y and press ENTER to accept the values and save the settings to EEPROM.

The calibration for the -10 V - +10 V input range is now complete.



### 2.1.2.2. Verifying the Calibration

- Step 1. Set the calibration source to output a voltage to channel 0 on the I-8014W module. For example, -2 V.
- Step 2. In the same calibration program console window, type t (Read the calibrated AI value for Ch0), and then select the input type that was just calibrated (e.g., 0, -10 V -10 V).
- Step 3. Confirm that the values displayed for channel 0 are correct.

```
7188XW 1.31 [COM1:115200,N,8,1],FC=0,CTS=1, DIR=D:\temp
*****
Please choose (0^3,r,t,s,q):t
*****
* (0)Read Gain_0 -10.00U to +10.00U *
* (1)Read Gain_1 - 5.00U to + 5.00U *
* (2)Read Gain_2 - 2.50U to + 2.50U *
* (3)Read Gain_3 - 1.25U to + 1.25U *
* (q)quit *
*****
Please choose (0^3,q):0
Please input voltage source (-10.0~+10.0)
Press any key continue, 'q' quit.....
AI value=-2.0027
AI value=-2.0028
AI value=-2.0028
AI value=-2.0030
```

### 2.1.2.3. Restoring the Default Calibration Settings

When using the default input impedance of 200 k $\Omega$ , the calibration program provides a Recover Default Calibration Settings (r) function that can be used to restore the gain and offset values to the factory default settings.

```
7188xw 1.31 [COM1:115200,N,8,1],FC=0,CTS=1, DIR=C:\Program
+/- 10U      Gain =34074 Offset =-74
+/- 5U       Gain =34072 Offset =-76
+/- 2.5U     Gain =34069 Offset =-84
+/- 1.25U    Gain =34054 Offset =-79
+/- 20mA     Gain =34069 Offset =-84

Gain/Offset parameters which in using
+/- 10U      Gain =31383 Offset =-64
+/- 5U       Gain =31359 Offset =-68
+/- 2.5U     Gain =34069 Offset =-84
+/- 1.25U    Gain =34054 Offset =-79
+/- 20mA     Gain =34069 Offset =-84

*****
* <0>Calibrate Gain_0 -10.00U to +10.00U *
* <1>Calibrate Gain_1 - 5.00U to + 5.00U *
* <2>Calibrate Gain_2 - 2.50U to + 2.50U *
* <3>Calibrate Gain_3 - 1.25U to + 1.25U *
* <r>Recover default calibration settings *
* <t>Read calibrated AI value of Ch0 *
* <s>Show calibrated Gain/Offset parameters *
* <q>quit *
*****
Please choose (0~3,r,t,s,q):r

Backup default Gain/Offset parameters settings for 100K
+/- 10U      Gain =34074 Offset =-74
+/- 5U       Gain =34072 Offset =-76
+/- 2.5U     Gain =34069 Offset =-84
+/- 1.25U    Gain =34054 Offset =-79
+/- 20mA     Gain =34069 Offset =-84

Gain/Offset parameters which in using
+/- 10U      Gain =34074 Offset =-74
+/- 5U       Gain =34072 Offset =-76
+/- 2.5U     Gain =34069 Offset =-84
+/- 1.25U    Gain =34054 Offset =-79
```

## 2.2. Windows-based Controllers

This section contains:

- Getting Started, see section 2.2.1
- Calibration, see section 2.2.2

## 2.2.1. Getting Started

The `pac_i8014W_BasicInfo.exe` executable file, which is located in the BasicInfo folder of the I-8014W demo programs, can be used to retrieve the basic configuration information related to the I-8014W and to verify the AI read functions. The basic configuration information includes:

- The Version number and the published date of the library.
- The FPGA version
- The single-ended/differential jumper settings
- The gain and offset values for each input range
- The data read on each channel

(See the Location of the Demo Programs section on page 12 for details of where to find the `pac_i8014W_BasicInfo.exe` in the I-8014W demo programs folder)

- Step 1. Refer to the Jumper Settings section on page 8. Ensure that the Differential/Single-ended selection jumper is in the differential position.
- Step 2. Connect a stable signal source (e.g., a battery output) to the I-8014W using the differential iring method.
- Step 3. Insert the I-8014W into a vacant slot in the control unit and power on the controller.

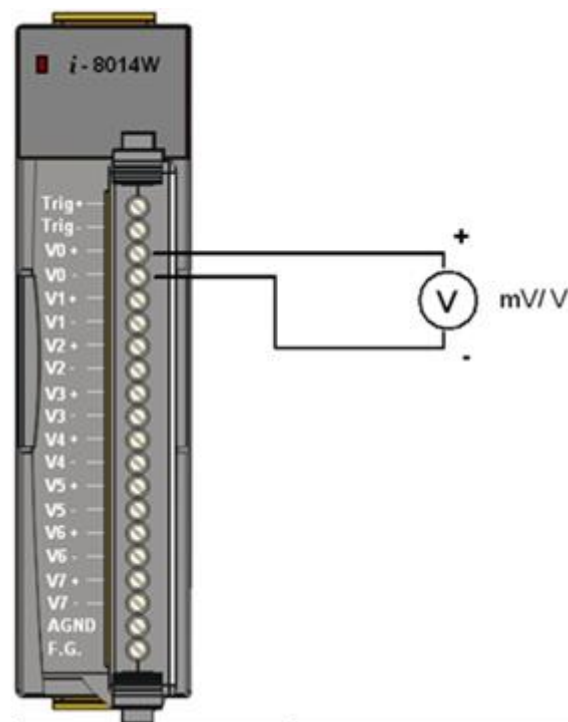

Step 4. Launch the pac\_i8014W\_BasicInfo.exe executable file on the controller, and verify that the basic information and the AI data read from each channel is correct, as indicated in the diagram below:

### Tips & Warnings



Unused channels should be connected to GND to avoid floating.

Library and FPGA version information Single-ended/differential

Form1

I-8014W slot Index Slot 0 Firmware 1 1 Firmware 2 2

Library Version 1007 Single-Ended/ Differential Differential

+/- 10.0 V Gain Value 32833 Offset Value -39

CH:0	Gain[1] 2.664	CH:8	
CH:1	Gain[1] 2.664	CH:9	
CH:2	Gain[1] 2.664	CH:10	
CH:3	Gain[1] 2.664	CH:11	
CH:4	Gain[1] 2.663	CH:12	
CH:5	Gain[1] 2.664	CH:13	
CH:6	Gain[1] 2.664	CH:14	
CH:7	Gain[1] 2.664	CH:15	

The gain value is around 33000. If this value varies significantly from 33000, it means that the value is incorrect.

Verify the AI data from each channel.

Note: I-8014CW only can select max 8 channels and +/- 20 mA Input Range

## 2.2.2. Calibration

Each I-8014W is factory calibrated and well verified before shipment, so it is usually unnecessary to calibrate the module again, unless the input impedance is changed on a calibrated module, or the accuracy is lost.

To calibrate the I-8014W, in addition to inserting the I-8014W into a controller slot, the following items are required:

- A single stable calibration source, such as a 3 1/2 digit power supplier (or better), or a battery output.
- A single 4 1/2 digit voltage meter (15-bit resolution or better)
- A Calibration Program. See page 12 for the Location of the Demo Programs contained in the I-8014W demo programs folder.

---

### Tips & Warnings

---



1. An unstable calibration source will cause calibration errors and affect the accuracy of the data acquisition.
  2. If you wish to perform calibration using  $\pm 20$  mA, select  $\pm 2.5$  V instead as both types use the same gain and offset values.
  3. The calibration program uses channel 0 to accept the calibration source only.
- 

This section contains:

- Calibrating the I-8014W on WinCE and WES units, see section 2.2.2.1
- Verifying the Calibration, see section 2.2.2.2
- Restoring the Default Calibration Settings, see section 2.2.2.3

### 2.2.2.1. Calibrating the I-8014W on WinCE and WES units

- Step 1. Refer to the Jumper Settings section on page 8. Ensure that the Differential/Single-ended selection jumper is in the differential position.
- Step 2. Connect your calibration source to channel 0 of the I-8014W using the differential wiring method, as illustrated.
- Step 3. Insert the I-8014W into a vacant slot on the controller and power on the controller.
- Step 4. Launch the pac\_i8014W\_Calibration.exe executable file on the controller to display the Calibration dialog box.

(See the Location of the Demo Programs section on page 12 for details of where to find the c# demos for the I-8014W)

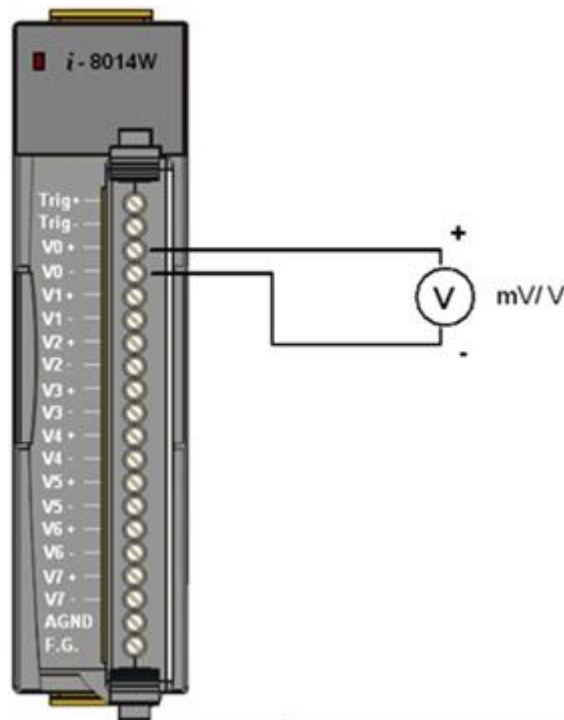

#### Tips & Warnings

---



Only channel 0 can be used to perform calibration.

---

Step 5. In the upper section of the Calibration dialog box, select the I-8014W slot number and input range from the respective drop-down lists.

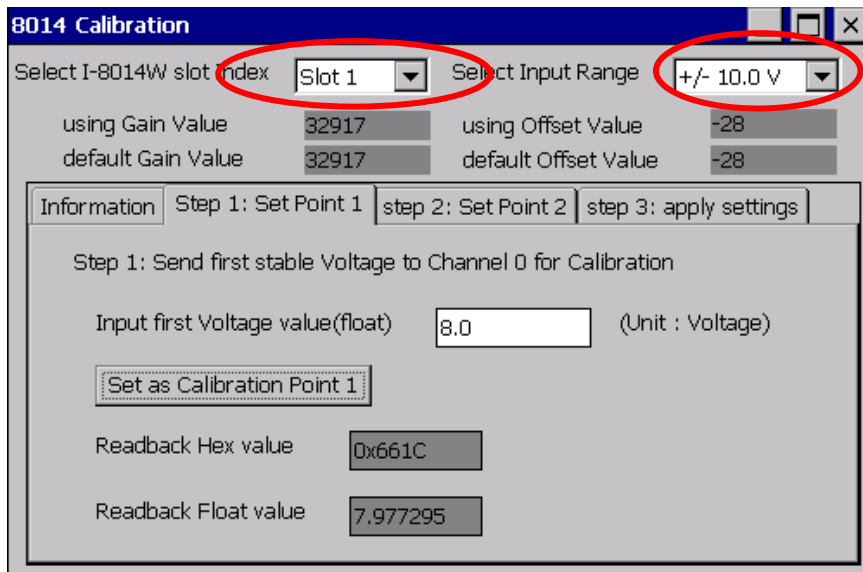

Note: I-8014CW only can select max 8 channels and +/- 20 mA Input Range

Step 6. Determine two values (points) within the range of the input type selected for the calibration process.

For example, after selecting -10 V - +10 V as the input range, +8 V and -8 V can be used as the two calibration points:

Step 7. Set the calibration source output to one of the two points (e.g., 8 V)





Step 8. Click the Step 1: Set Point 1 tab and type the value displayed on the meter (e.g., 8.0) in the Input First Voltage Value text box, and click the Set as Calibration Point 1 button.

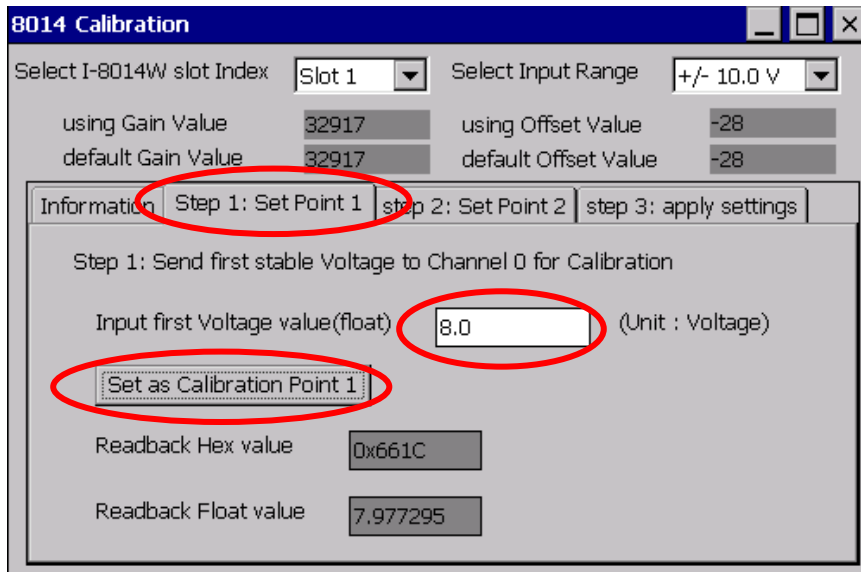

Step 9. Set the calibration source output to the other value (e.g., - 8 V in this example)

Step 10. Click the Step 2: Set Point 2 tab and type the value displayed on the meter

(e.g., - 8.0) in the Input Second Voltage Value text box, and click the Set as Calibration Point 2 button.

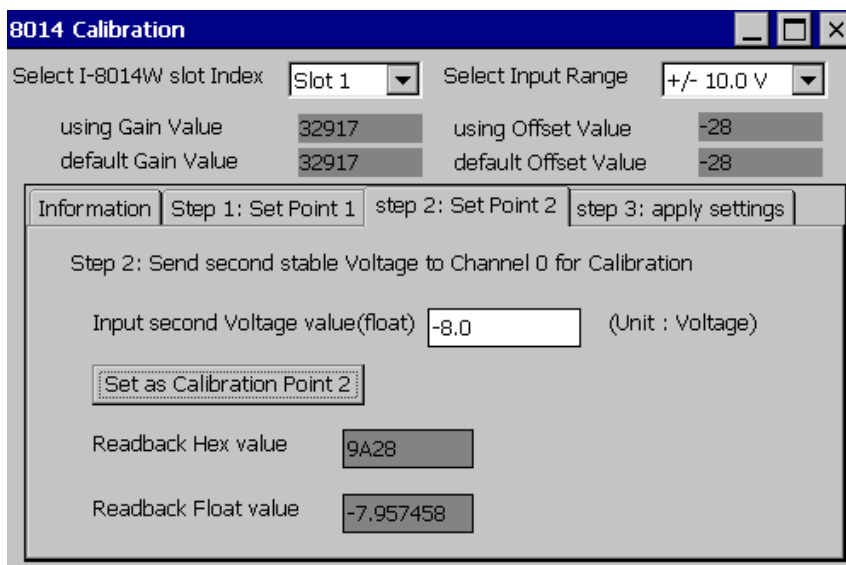

Step 11. Click the Step 3: Apply Settings tab, and then check that the calibration parameters are correct.  
Click the Save New Calibration Settings button to save the calibration settings.

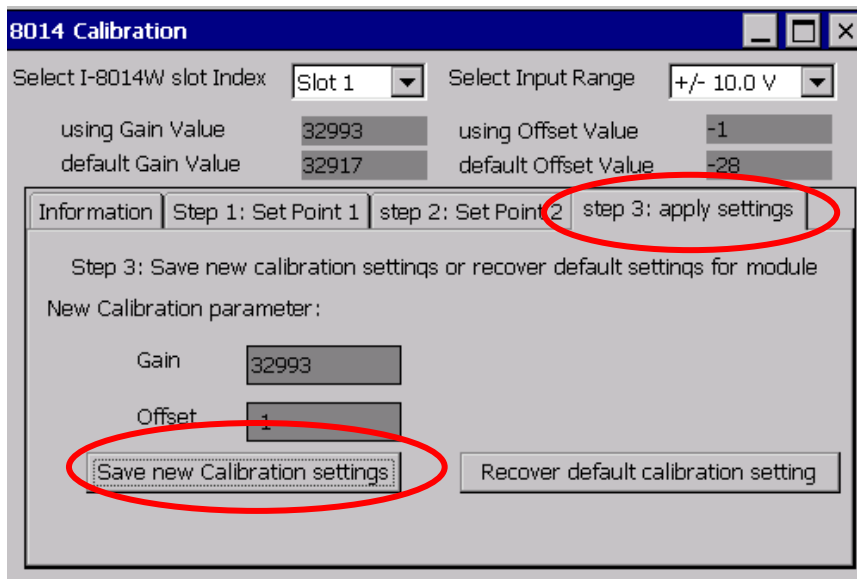

The calibration for the -10 V - +10 V input range is now complete.

### 2.2.2.2. Verifying the Calibration

- Step 1. Set the calibration source to output a voltage to channel 0 on the I-8014W module. For example, -2 V.
- Step 2. In the Calibration dialog box, click the Step 1: Set Point 1 tab and confirm that the AI Readback Float value is as illustrated in the image below:

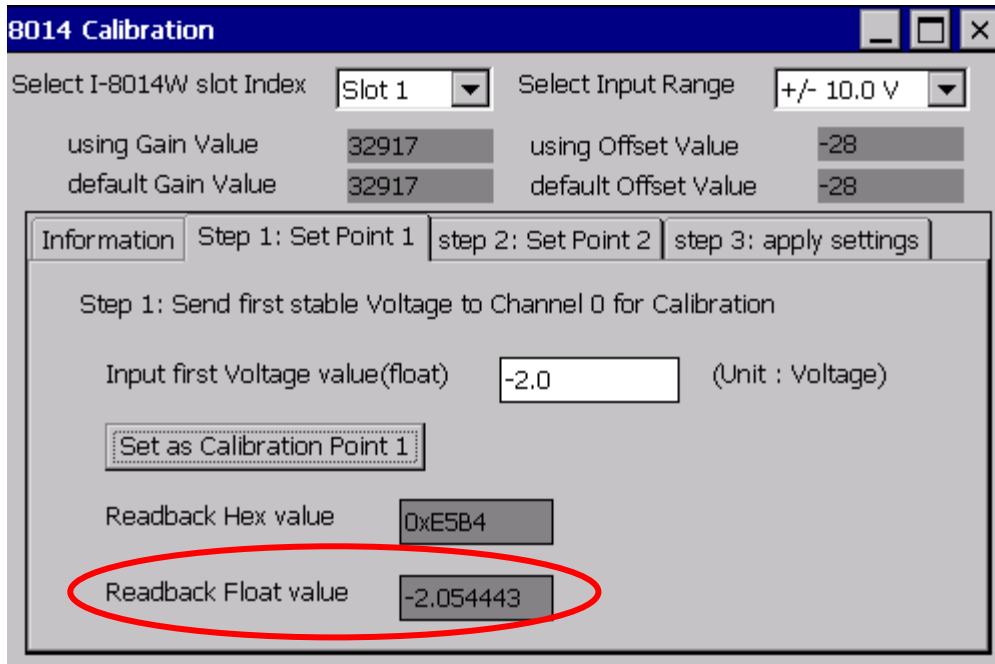

### 2.2.2.3. Restoring the Default Calibration Settings

When using the default input impedance of 200 k $\Omega$ , the calibration program includes a Recover Default Calibration Settings function that can be used to restore the gain and offset values to the factory default values:

Click the Step 3: Apply Settings tab, and then click the Recover Default Calibration Settings button. The gain and offset settings will be restored to the factory default values and will be displayed in the upper section of the Calibration dialog box.

For 200k Ohm (default setting) input impedance, the calibration program provides Recover default calibration settings function to recover the gain and offset values to factory default:

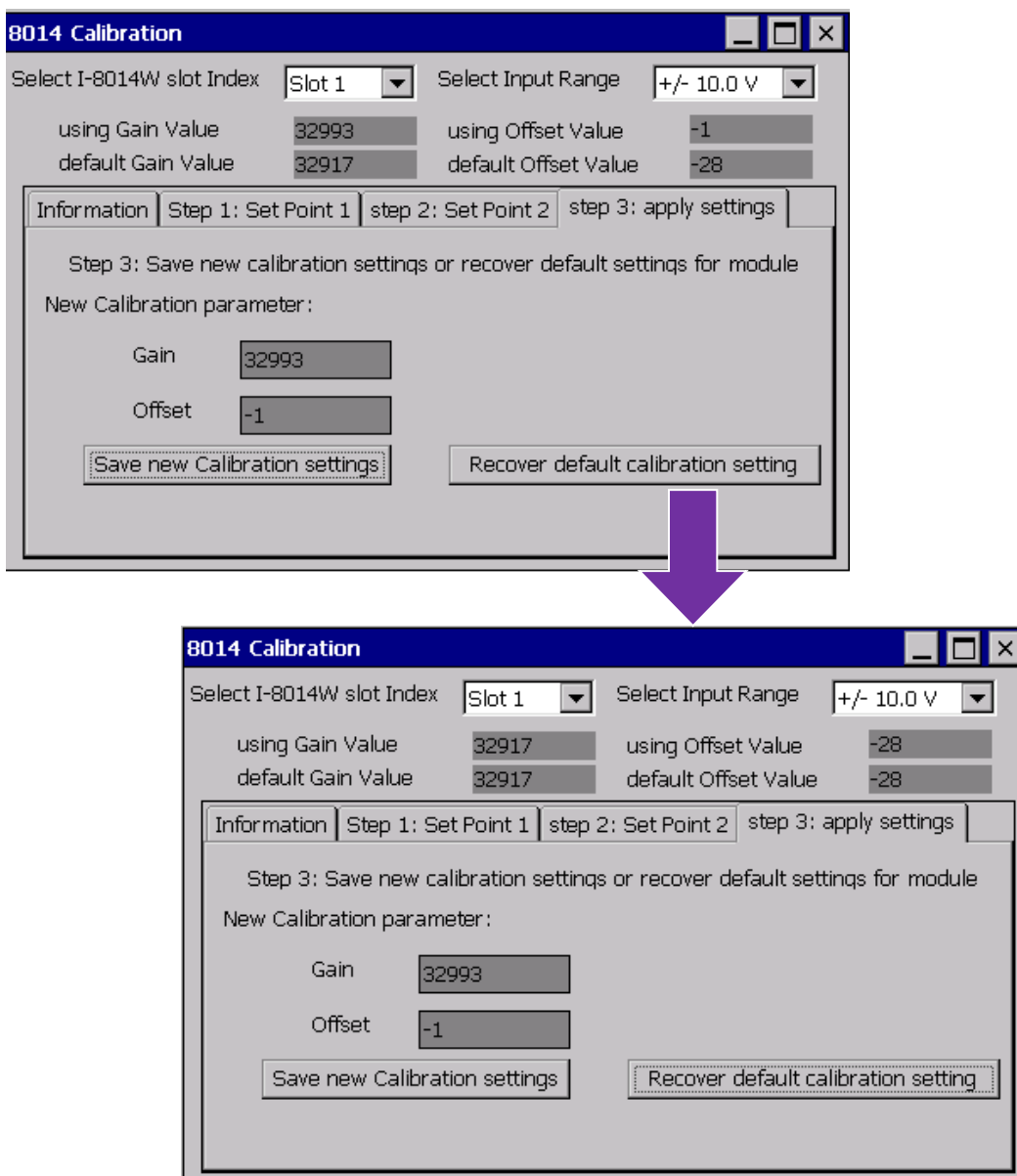

### 3. Magic Scan

This chapter provides details related to Magic Scan, which is a key function included on the I-8014W for multi-channel analog data acquisition at high sampling rates.

Two demo programs that can be used to implement Magic Scan functionality are included at the end of this chapter. Either Magic Scan mode or the trigger method can be selected for use in the two programs, and the only difference is that Magic Scan mode uses polling to transfer data and the trigger method transfers data using interrupts.

This chapter contains:

- [The Advantages of Magic Scan](#), see section 3.1

## 3.1. The Advantages of Magic Scan

This section contains:

- [High speed AD with high precision Timer request](#), see section 3.1.1
- [Magic Scan, read AD from 4K AI FIFO](#), see section 3.1.2
- [4K AI FIFO with FIFO level limit interrupt to reduce the CPU loading greatly](#), see section 3.1.3
- [Application Examples](#), see section 3.1.4

### **3.1.1. High speed AD with high precision Timer request**

For normal AD sampling application, it needs a high precision timer to handle the sample rate, and it is very difficult to have less than 1 ms timer ISR on multi task operation system,

For I-8014W to sample AD, If we configure the sample rate of Magic Scan , it will use independent internal hardware clock to trigger AD, it does not rely on platform's Timer ISR

### **3.1.2. Magic Scan, read AD from 4K AI FIFO**

Magic Scan convert AD to 4K FIFO automatically, program can read AI data from FIFO any time before FIFO full.

For normal AD modules, they need to use command to trigger the AD convert and wait time for ready signal for each sampling event.



### 3.1.3.4K AI FIFO with FIFO level limit interrupt to reduce the CPU loading greatly

I-8014W can set FIFO limit level for interrupt service notification. This feature can increase the performance for sampling application. Program don't need to sample data all the time, but to wait for CPU's interrupt notification if AI data count in FIFO reach the limit level.

FIFO limit level	Limit Data count to trigger interrupt
0	8
1	16
2	32
3	64
4	128
5	256
6	512
7	2048

### 3.1.4. Application Examples

This section contains:

- [To sample 16 channels'AI in 1 ms Timer ISR](#), see section 3.1.4.1
- [250KHz application](#), see section 3.1.4.2
- [10KHz sample rate for two I-8014W](#), see section 3.1.4.3

### 3.1.4.1. To sample 16 channels'AI in 1 ms Timer ISR

To achieve this specification

1. System must provide 1ms Timer Interrupt Service.
2. The maximum sample rate of Analog Input module must above 16KHz/sec (16 Data/ms),if application need PID control or other operation in 1 ms, it need higher sample rate.

If we take a 16-channel AI module with maximum sample rate 30KHz for example, to sample 16 data by using this AI module needs about 0.54 ms ( $(1000\text{ms}/30000)*16 = 0.54\text{ms}$ ), it means in 1ms Timer Interrupt Service Routine, it spends 540us to scan 16 channels AI data, and there will have 460us left to do other control logic.

If we set I-8014W scan mode as Sample and Hold, FIFO level limit trigger as 16 AI data, sample rate 1KHz. It means that there will be a FIFO ISR in every 1ms, when program receive Interrupt notification, it just needs 11us~26us to read 16 AI data from FIFO, it remains 970 us can do its control logic work.

### 3.1.4.2. 250KHz application

I-8014W can set 250 KHz sample rate in standard mode. Below diagram shows how it works. The key feature is the speed to read 1 AI data from FIFO is faster than AD convert.

If we set FIFO Limit level as 7 (2048 AI to trigger Interrupt Service), it needs 8.2 ms to convert 2048 AI data, and 3~6.5 ms to read 2048 AI data from FIFO.

### 3.1.4.3. 10KHz sample rate for two I-8014W

Scan parameters for each I-8014W.

Sample rate	Scan channels	Scan Mode	FIFO limit level
10KHz	8	Sample and Hold	7 (2048 AI)

Under 10KHz Sample and Hold mode,

1. It will be (80K AI data)/sec for each slot
2. It will trigger FIFO limit Interrupt every 25.6 ms,  $(2048 * 1000) / (80000) = 25.6$
3. There will be about 11 ms left after to get data from two slot FIFO

In this application, it needs to convert 160K AI Data from two I-8014W, and this is done by I-8014W itself without using any CPU resource, program just needs to wait for FIFO ISR notification and read data from FIFO.

- Magic Scan Mode, see section 3.2

- Trigger Methods, see section 3.3
- FIFO, see section 3.4
- Magic Scan Procedure, see section 3.5
- [Magic Scan Example](#), see section 3.6 -- which describes the two data transfer modes used with Magic Scan.
- Case Study, see section 3.7

## 3.2. The Advantages of Magic Scan

This section contains:

- [High speed AD with high precision Timer request](#), see section 3.1.1
- [Magic Scan, read AD from 4K AI FIFO](#), see section 3.1.2
- [4K AI FIFO with FIFO level limit interrupt to reduce the CPU loading greatly](#), see section 3.1.3
- [Application Examples](#), see section 3.1.4

### 3.2.1. High speed AD with high precision Timer request

For normal AD sampling application, it needs a high precision timer to handle the sample rate, and it is very difficult to have less than 1 ms timer ISR on multi task operation system,

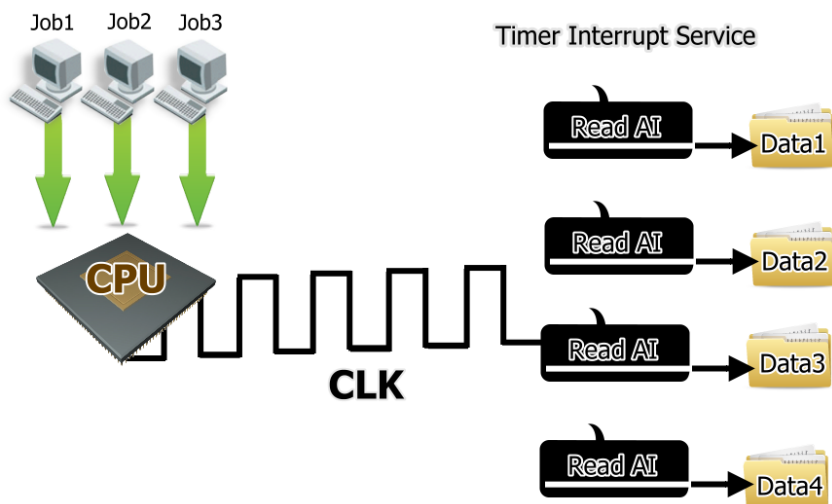

For I-8014W to sample AD, If we configure the sample rate of Magic Scan , it will use independent internal hardware clock to trigger AD, it does not rely on platform's Timer ISR

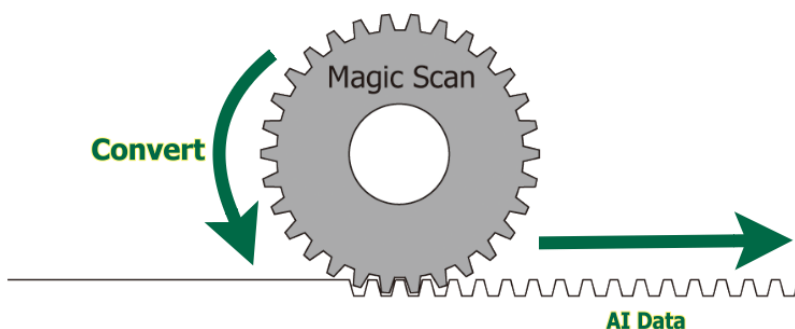



### 3.2.2. Magic Scan, read AD from 4K AI FIFO

Magic Scan convert AD to 4K FIFO automatically, program can read AI data from FIFO any time before FIFO full.

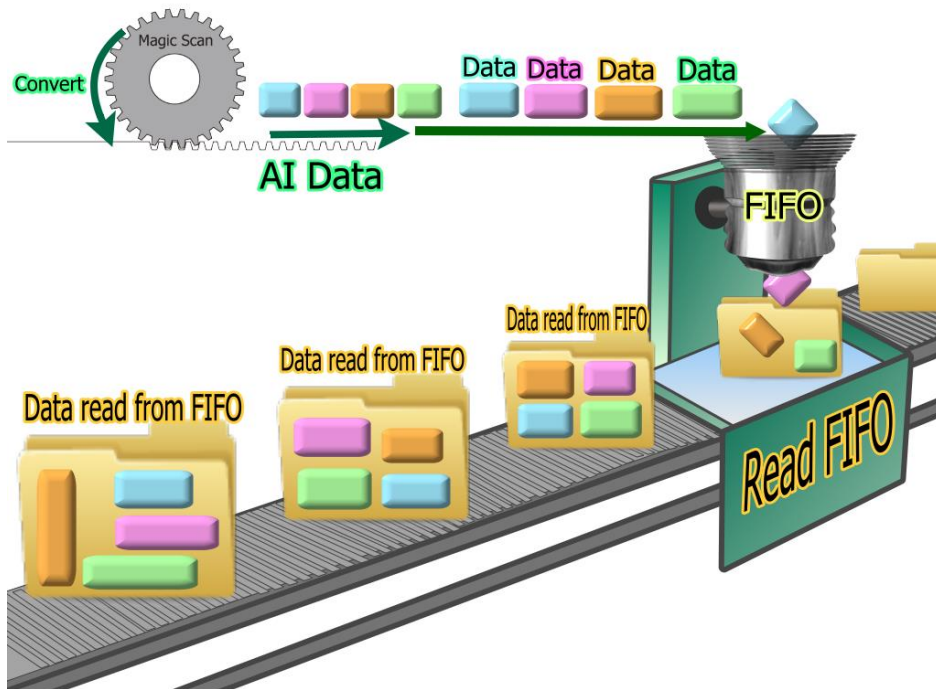

For normal AD modules, they need to use command to trigger the AD convert and wait time for ready signal for each sampling event.

### 3.2.3.4K AI FIFO with FIFO level limit interrupt to reduce the CPU loading greatly

I-8014W can set FIFO limit level for interrupt service notification. This feature can increase the performance for sampling application. Program don't need to sample data all the time, but to wait for CPU's interrupt notification if AI data count in FIFO reach the limit level.

FIFO limit level	Limit Data count to trigger interrupt
0	8
1	16
2	32
3	64
4	128
5	256
6	512
7	2048

## 3.2.4. Application Examples

This section contains:

- [To sample 16 channels'AI in 1 ms Timer ISR](#), see section 3.1.4.1
- [250KHz application](#), see section 3.1.4.2
- [10KHz sample rate for two I-8014W](#), see section 3.1.4.3

### 3.2.4.1. To sample 16 channels'AI in 1 ms Timer ISR

To achieve this specification

- 3. System must provide 1ms Timer Interrupt Service.
- 4. The maximum sample rate of Analog Input module must above 16KHz/sec (16 Data/ms),if application need PID control or other operation in 1 ms, it need higher sample rate.

If we take a 16-channel AI module with maximum sample rate 30KHz for example, to sample 16 data by using this AI module needs about 0.54 ms ( $(1000ms/30000)*16 = 0.54ms$ ), it means in 1ms Timer Interrupt Service Routine, it spends 540us to scan 16 channels AI data, and there will have 460us left to do other control logic.

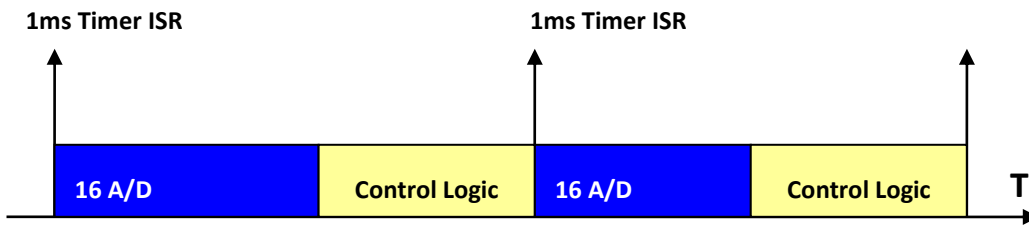

If we set I-8014W scan mode as Sample and Hold, FIFO level limit trigger as 16 AI data, sample rate 1KHz. It means that there will be a FIFO ISR in every 1ms, when program receive Interrupt notification, it just needs 11us~26us to read 16 AI data from FIFO, it remains 970 us can do its control logic work.

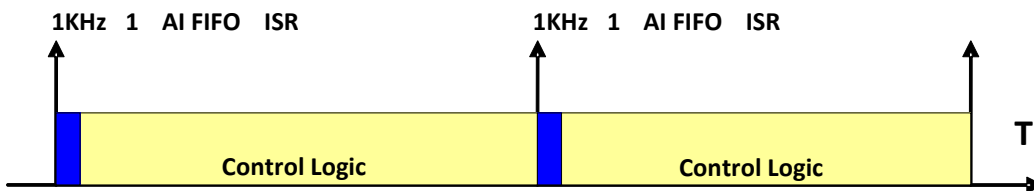

### 3.2.4.2. 250KHz application

I-8014W can set 250 KHz sample rate in standard mode. Below diagram shows how it works. The key feature is the speed to read 1 AI data from FIFO is faster than AD convert.

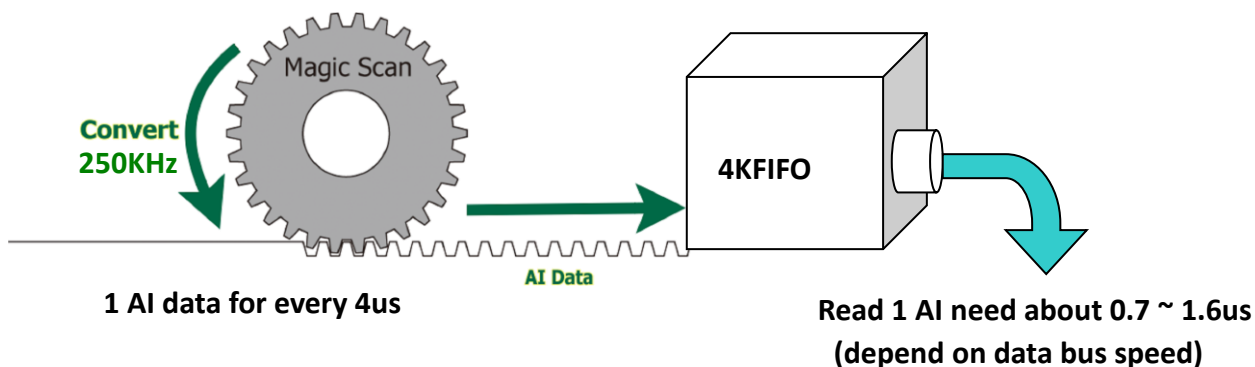

If we set FIFO Limit level as 7 (2048 AI to trigger Interrupt Service), it needs 8.2 ms to convert 2048 AI data, and 3~6.5 ms to read 2048 AI data from FIFO.

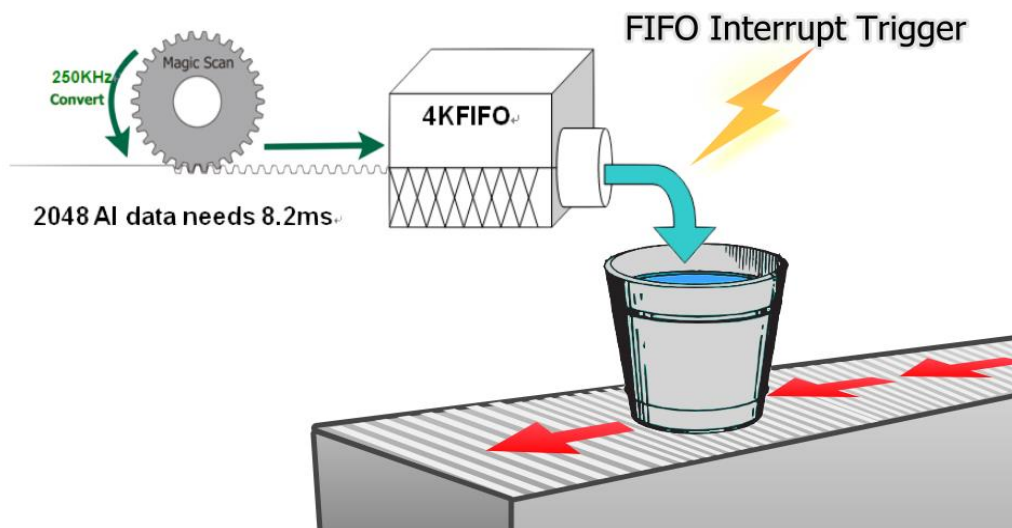

### 3.2.4.3. 10KHz sample rate for two I-8014W

Scan parameters for each I-8014W.

Sample rate	Scan channels	Scan Mode	FIFO limit level
10KHz	8	Sample and Hold	7 (2048 AI)

Under 10KHz Sample and Hold mode,

4. It will be (80K AI data)/sec for each slot
5. It will trigger FIFO limit Interrupt every 25.6 ms,  $(2048 * 1000) / (80000) = 25.6$
6. There will be about 11 ms left after to get data from two slot FIFO

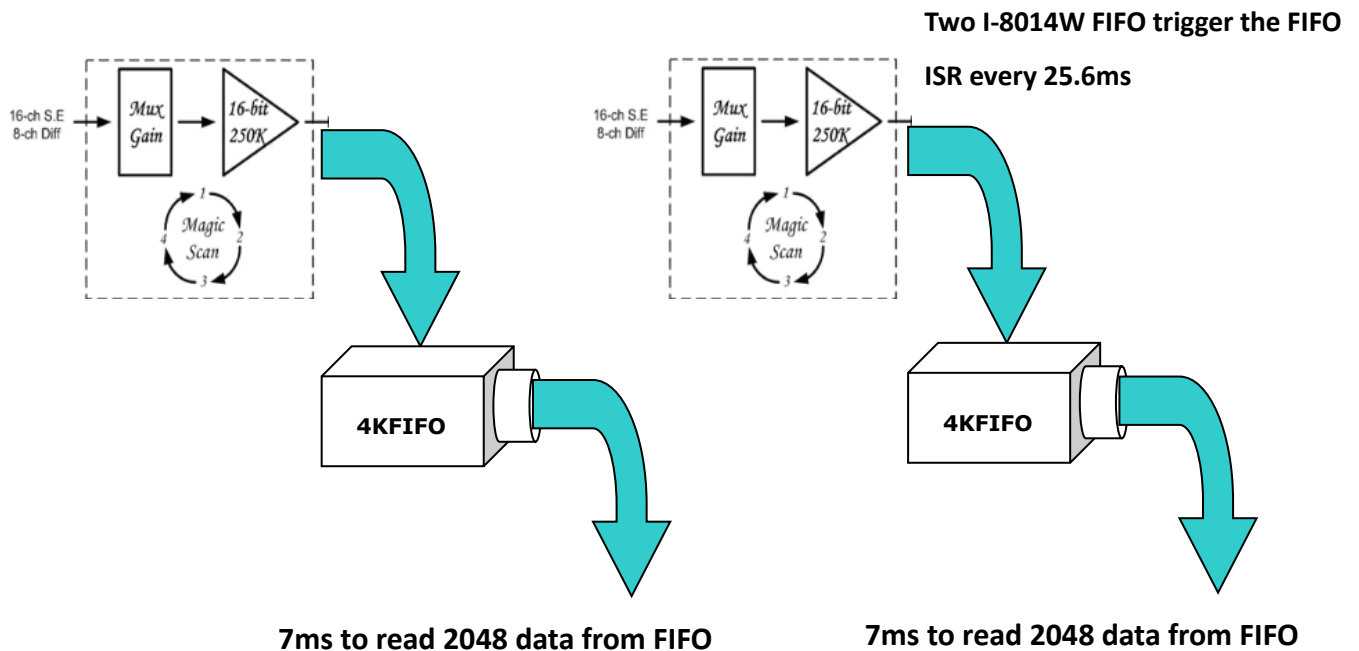
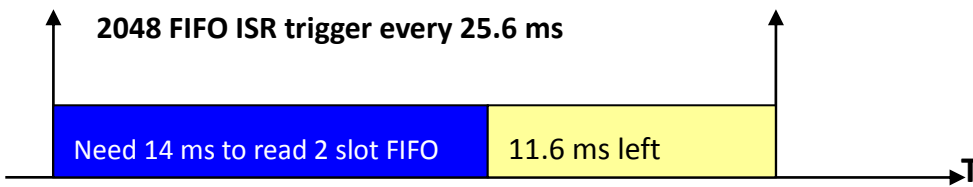

In this application, it needs to convert 160K AI Data from two I-8014W, and this is done by I-8014W itself without using any CPU resource, program just needs to wait for FIFO ISR notification and read data from FIFO.

### 3.3. Magic Scan Mode

For multi-channel high speed data acquisition systems, the I-8014W provides sampling rates of up to 250 kHz and a 4k-sample FIFO that reduces the loading of the CPU and enhances the performance of your system.

The following is an overview of the Magic Scan specifications:

Max. Channels	16
Sampling Rate	2 Hz ~ 250 kHz
FIFO	4 k samples
Sampling Mode	- Standard - Virtual Sample and Hold
Trigger Method	- Software - Internal Hardware - External Hardware
Data Transfer Mode	- polling - Interrupt

This section describes the two Magic Scan modes that can be used on the I-8014W:

- Standard Mode, see section 3.1.1
- Virtual Sample and Hold Mode, see section 3.1.2

### 3.3.1. Standard Mode

In standard mode, the I-8014W converts data from a single channel in each sampling interval.

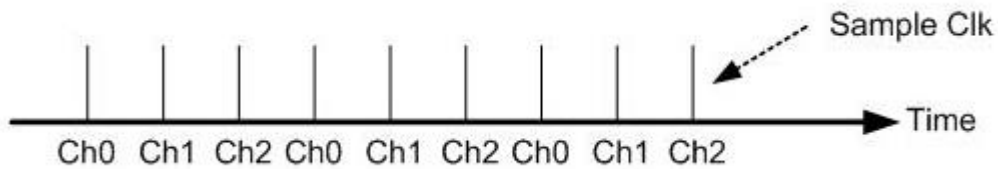

For example, if Ch0, Ch1 and Ch2 are configured to perform the scan function, and the sampling rate is set to 1 kHz, the interval between each sampling operation is 1 ms, so the scanning time for a single cycle (from Ch0 to Ch1 to Ch2) is 3ms, as illustrated below:

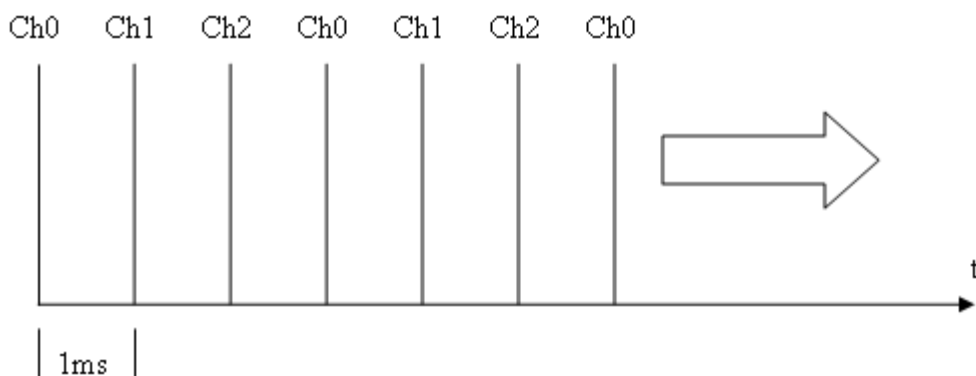



### 3.3.2. Virtual Sample and Hold Mode

Virtual sample and hold mode operates such that several channels can be configured to perform scanning functions and are sampled at the same time. The sampling rate is set to 250 kHz by default, and the scan cycle time is the interval that is set in the Magic Scan function.

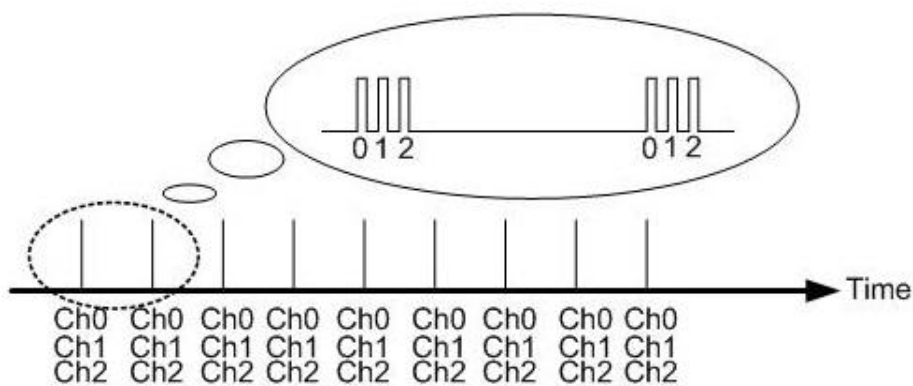

For example, if the sampling rate is set to 1 kHz and Ch0, Ch1, and Ch2 are configured to perform the scanning functions, the sampling rate for scanning Ch0 to Ch2 is 250 kHz, and the frequency of the scan cycle is 1 kHz, the interval between one scan cycle and the next is 1 ms.

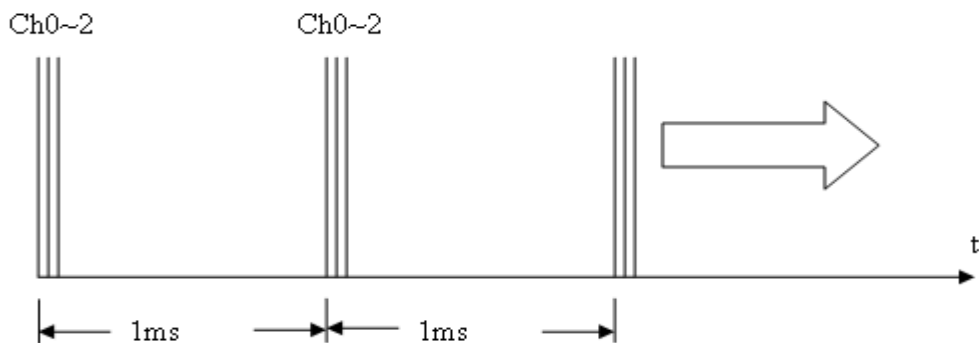

## 3.4. Trigger Methods

This section contains:

- Software Trigger Method, see section 3.2.1
- Internal Hardware Trigger Method, see section 3.2.2
- External Hardware Trigger Method, see section 3.2.3

### 3.4.1. Software Trigger Method

The API provides a trigger instruction that initiates Magic Scan. If you have two or more modules, you need to configure the Magic Scan parameters for each module and execute the Magic Scan instructions for the modules individually.

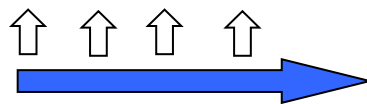

Execute Magic Scan on the first module and then repeat for the subsequent modules using software instructions.

### 3.4.2. Internal Hardware Trigger Method

If you wish to simultaneously initiate the Magic Scan function on two or more modules, set the internal hardware signal as the trigger source in your program, and then the internal trigger signal will trigger the Magic Scan operation for the individual modules at almost the same time.

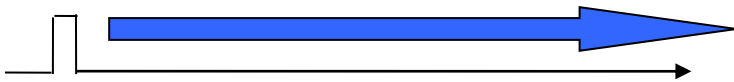

Trigger Magic Scan for each module using an internal hardware signal.

### 3.4.3. External Hardware Trigger Method

The Magic Scan function is also able to accept an external trigger source from the first two terminals, using this method, the trigger can be set as either rising edge or falling edge triggered. After setting the external trigger source and the triggering conditions, execute Magic Scan in your program. The I-8014W will wait until it receives the external signal from the Trig+ and Trig- terminals and will then execute Magic Scan.



### 3.5. FIFO

The I-8014W is equipped with a 4 k-sample FIFO buffer, which may be used to store 4096 data samples from Magic Scan to ensure that no data is lost. The acquisition data is sequentially saved to the FIFO buffer during the scan process. To prevent the FIFO buffer from being filled, the data needs to be read from the FIFO buffer within a specific timeframe. If the FIFO buffer is filled, data can no longer be saved until a command is executed that clears the FIFO buffer. In contrast, if data is read from the FIFO buffer too frequently, CPU resources will be wasted and performance will be affected. To achieve the optimum balance, two modes for transferring data from the FIFO are provided, polling mode and interrupt mode.

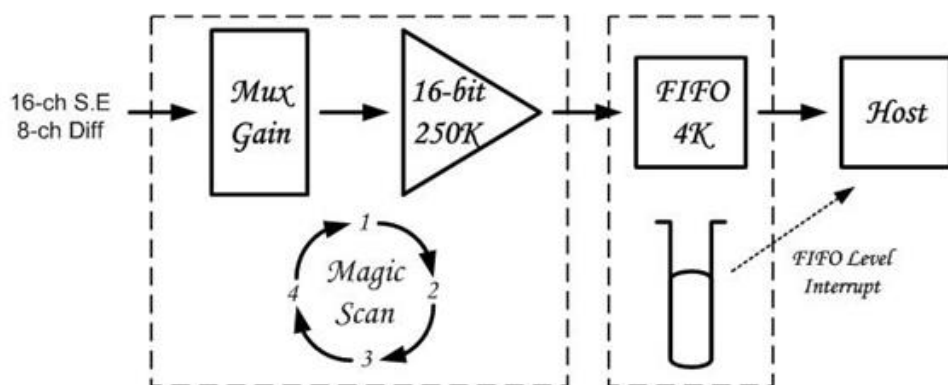

Note: I-8014CW only can select max 8 channels Differential Mode and +/- 20 mA Input Range

### 3.6. Magic Scan Procedure

The following is an illustration of the Magic Scan program procedure:

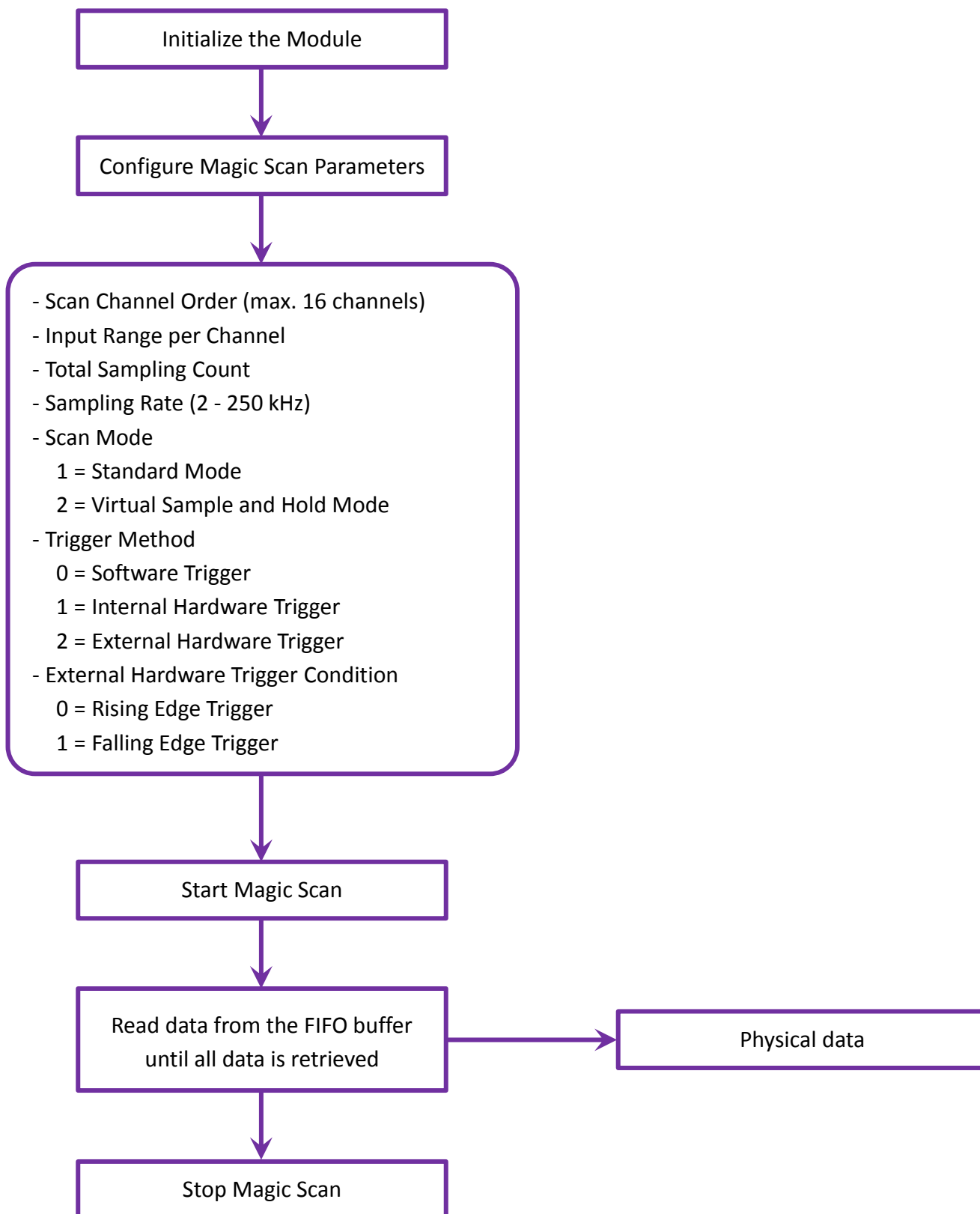

Note: I-8014CW only can select max 8 channels and +/- 20 mA Input Range

## 3.7. Magic Scan Example

This section includes information related to the two Magic Scan demo programs that are provided for different data transfer modes. See the Location of the Demo Programs section on page 12 for details of how to locate the demo program for your controller.

This section contains:

- Magic.exe, see section 3.5.1– for transferring data using the polling method
- Mag\_ISR.exe, see section 3.5.2– for transferring data using the interrupt method



### 3.7.1. Magic.exe

This section describes the parameters that should be set in Magic.exe, and separates the description for MiniOS7 and Windows platforms.

This section contains:

- Demo Program for MiniOS7, see section 3.5.1.1
- Demo Program on the Windows Platform, see section 3.5.1.2

### 3.7.1.1. Demo Program for MiniOS7

The following figure shows the interface and parameters that should be set in Magic.exe for the MiniOS7 platform.

This Demo will show how to use magic scan function to read analog input

Search I-8014W ....  
 There is an i8014 at slot 0  
 i8014W Input Mode=Differential and can have maximum 8 analog input

Input all i8014W\_ConfigMagicScan parameters :

**Step 1:** Define scanned channel counts for magic scan:  
 Input scanned channel counts (1~16) :4  
 Now we have scanned channel counts = 4

**Step 2:** Define 4 elements for channel and gain array  
 The Gain definition of I-8014W  
 Select 0 : +/-10V  
 Select 1 : +/-5V  
 Select 2 : +/-2.5V  
 Select 3 : +/-1.25V  
 Select 4 : +/-20mA

Differential Mode range : channel 0 ~ 7  
 Select which Channel of Arr[0] (0~7) :0  
 Select which Gain of Arr[0] (0~4):0  
 Select which Channel of Arr[1] (0~7) :1  
 Select which Gain of Arr[1] (0~4):0  
 Select which Channel of Arr[2] (0~7) :2  
 Select which Gain of Arr[2] (0~4):0  
 Select which Channel of Arr[3] (0~7) :3  
 Select which Gain of Arr[3] (0~4):0

**Step 3:** Define Sample Rate of I-8014W  
 Input Sample rate of 8014W (1~2500000) :200  
 Note: the real sample rate may not the same as user input  
 the function i8014W\_ConfigMagicScan return code is the  
 real sample rate accepted by I-8014W

**Step 4:** Select Scan Mode of I-8014W:  
 Scan Mode 1= M1 Standard Mode  
 Scan Mode 2= M2 Sample and Hold Mode  
 Input Scan Mode of 8014W (1 or 2) :1

**Step 5:** Select Trigger Source of I-8014W,  
 I-8014W can have 3 types of trigger source  
 trigger source 0= Software Command  
 trigger source 1= Internal Interrupt Signal  
 trigger source 2= External Trigger Signal  
 Input trigger source of 8014W (0~2) :0

**Step 6:** Select Trigger State of I-8014W if select external trigger  
 Not external trigger source, trigger state = 0

The Magic Scan Configurations of I-8014W are:  
 Scan channel count = 4  
 CH[0]= 0 Gain[0]= 0 ( +/-10V )  
 CH[1]= 1 Gain[1]= 0 ( +/-10V )  
 CH[2]= 2 Gain[2]= 0 ( +/-10V )  
 CH[3]= 3 Gain[3]= 0 ( +/-10V )  
 Scan Mode = 1 ( Standard Mode )  
 Trigger Source = 0 ( Software Command )  
 Trigger State = 0 ( No need for External Trigger Signal )  
 Set Sample Rate = 200.000 Real Sample Rate = 200.000

Press any key to start magic scan

**Step 1.** Enter the total number of the scanning channels. (form 1 to 16)

**Step 2.** Set the channel number and the input range for the channel. Note that the channel sequence entered determines the scan order.

**Step 3.** Enter the sampling rate.

**Step 4.** Enter the scanning rate.

**Step 5.** Select the trigger method.

**Step 6.** Set the trigger conditions if an external trigger is selected in step 5.

The configured parameters.

After the Magic Scan parameters have been set, press any Key to Start Magic Scan, as shown in the figure below.

If the scan mode is set to standard mode, the total spend time will be equal to [1000] multiplied by the [sampling period]. (1000 is the total sample count defined in the demo program)

```
Press any Key to Start magic scan
Wait for Magic Scan .....

Stop magic scan and FIFO data amount = 1000
Magic scan total spend time = 4999 ms

Press 's' or 'S' to Show AI, others to next step
Start to Print all data:

Arr[0]=F[2.6645]      Arr[1]=F[2.6642]      Arr[2]=F[2.6645]      Arr[3]=F[2.6645]
Arr[0]=F[2.6642]      Arr[1]=F[2.6645]      Arr[2]=F[2.6645]      Arr[3]=F[2.6642]
Arr[0]=F[2.6642]      Arr[1]=F[2.6645]      Arr[2]=F[2.6642]      Arr[3]=F[2.6642]
Arr[0]=F[2.6642]      Arr[1]=F[2.6639]      Arr[2]=F[2.6645]      Arr[3]=F[2.6642]
Arr[0]=F[2.6639]      Arr[1]=F[2.6645]      Arr[2]=F[2.6645]      Arr[3]=F[2.6642]
Arr[0]=F[2.6645]      Arr[1]=F[2.6645]      Arr[2]=F[2.6642]      Arr[3]=F[2.6645]
Arr[0]=F[2.6642]      Arr[1]=F[2.6642]      Arr[2]=F[2.6642]      Arr[3]=F[2.6642]
Arr[0]=F[2.6642]      Arr[1]=F[2.6642]      Arr[2]=F[2.6642]      Arr[3]=F[2.6645]
```

Note: I-8014CW only can select max 8 channels and +/- 20 mA Input Range

### 3.7.1.2. Demo Program on the Windows Platform

The following figure illustrates the interface and parameters that need be set when using Magic.exe on a Windows platform.

**Step1.** Select the slot and the scan channel count. (From 1 to 16)

**Step2.** Select the trigger source and enter the input sampling rate. If an external trigger source is selected, also select the trigger state.

**Step3.** Select the scan mode.

**Step4.** Select the channel scan order and the type for each channel.

**Step5:** Press the **Set** button.

Step6. Click the Start Magic Scan tab, and press the Start Magic Scan button.

The data will be displayed in the right frame for each channel.

## Viewing the Results for Standard Scan Mode

To view the results of the scan in Standard Scan Mode, click the Start Magic Scan tab. When the sampling rate is set to 200 Hz, the sampling period will be  $1/200 * 1000 = 5$  ms. The spend time equals the [total sample count] multiplied by the [sampling period].

In this example, the spend time is 5004 ms, which is equal to about 1000 (the total sample count defined in the code) multiplied by 5 (the sampling period).

The screenshot shows a software window titled 'Form1' with two tabs: 'Configure Magic Scan' and 'Start Magic Scan'. The 'Start Magic Scan' tab is selected. It contains a 'Start Magic Scan' button, a 'Save Data to file' button, and an 'Exit' button. Two input fields are present: 'Total Scanned' with the value '1000' and 'Samples', and 'Spend Time' with the value '5004' and 'ms'. Below these fields is a text area containing configuration details for an I-8014W module, including channel gain arrays, scan channel count (4), total sample count (1000), and scan mode ('M1:Standard'). The results section displays a list of channel values (CH[0] through CH[3]) and their corresponding gains.

Channel	Gain	Value
CH[0]	0	2.600098
CH[1]	1	2.599487
CH[2]	2	-2.600708
CH[3]	3	2.599792

Note: I-8014CW only can select max 8 channels and +/- 20 mA Input Range

## Viewing the Results for Virtual Sample and Hold Mode

To view the results of the scan in Virtual Sample and Hold Mode, click the Start Magic Scan tab. When the sampling rate is set to 200 Hz, the period for one scan cycle is  $1/200 * 1000 = 5$  ms.

The number of scan cycles = [Total sample count] / [Total number of scanning channels].

In this example, the spend time 1254 ms =  $(1000 / 4) * 5$

(Spend time = [number of scan cycles] \* [scan cycle period])

The spend time can be used to verify the sampling rate on the I-8014W.

The screenshot shows a software window titled 'Form1' with two tabs: 'Configure Magic Scan' and 'Start Magic Scan'. The 'Start Magic Scan' tab is active. It contains several input fields and buttons. The 'Total Scanned' field is set to '1000' and 'Samples' is '4'. The 'Spend Time' field is set to '1254' and 'ms'. There is an 'Exit' button. Below these fields is a text area containing the following information:

```
Selected Magic Scan Channel Gain Array[0] C = 0 G = 0 CH[0]= 2.599792
Selected Magic Scan Channel Gain Array[1] C = 1 G = 0 CH[1]= 2.600403
Selected Magic Scan Channel Gain Array[2] C = 2 G = 0 CH[2]= -2.601624
Selected Magic Scan Channel Gain Array[3] C = 3 G = 0 CH[3]= 2.598267
The Magic Scan Configurations of I-8014W are:
Scan channel count = 4, Total sample count =1000 CH[0]= 2.600403
CH[0]= 0 Gain[0]= 0 ( +/-10V ) CH[1]= 2.602234
CH[1]= 1 Gain[1]= 0 ( +/-10V ) CH[2]= -2.601929
CH[2]= 2 Gain[2]= 0 ( +/-10V ) CH[3]= 2.596741
CH[3]= 3 Gain[3]= 0 ( +/-10V ) CH[0]= 2.600098
Scan Mode = 2 ( M2:Sample and Hold ) CH[1]= 2.600403
Trigger Source = 0 ( Software Command ) CH[2]= -2.601318
Trigger State = 0 ( No need for External Trigger Signal ) CH[3]= 2.599487
Set Sample Rate = 200 Real Sample Rate = 200 CH[0]= 2.600098
CH[1]= 2.600403
CH[2]= -2.601318
CH[3]= 2.598572
CH[0]= 2.600403
CH[1]= 2.602234
CH[2]= -2.602539
```

Note: I-8014CW only can select max 8 channels and +/- 20 mA Input Range

### 3.7.2. Mag\_ISR.exe

Mag\_ISR.exe demonstrates how to transfer data using interrupts. When using this method, the Magic Scan parameter settings are identical to those used for Magic.exe. See the Magic Scan Procedure section on page 48 and the Magic.exe section on page 50 for more details. The only difference is that an interrupt service routine (ISR) must be installed before starting Magic Scan. This is achieved by adding the following code to your program:

```
i8014W_InstallMagicScanISR(slotIndex,Slot_ISR,triggerLevel);  
i8014W_StartMagicScan(slotIndex);
```

The installed ISR will process any interrupt tasks when an interrupt signal is detected from the FIFO, and the parameter triggerLevel is used to configure the interrupt conditions, as indicated in the following table:

triggerLevel	Data Count
0	8
1	16
2	32
3	64
4	128
5	256
6	512
7	2048

Once the amount of data in the FIFO buffer meets the level that was set via the triggerLevel parameter, an interrupt signal will be generated, and the code in the installed ISR will be processed. Note that you need to ensure that the interrupt function in the ISR is cleared, otherwise any subsequent interrupt requests will not be processed.

Using interrupts to transfer data helps to reduce CPU usage time which could be wasted when used for polling and waiting for data from the FIFO buffer.

## 3.8. Case Study

The requirements in this case are:

1. Measure four differential signals ranging from -10 V to +10V.
2. The sampling rate per channel is 200 Hz, and sampling time interval from one channel to the next channel is less than 10  $\mu$ s.
3. Once 2000 data samples have been collected, transfer the data via the Ethernet to a data center or a remote data storage disk.

Use the following procedure to meet the requirements:

- Step 1. Set the jumper on the I-8014W to differential input mode.
- Step 2. Set the input channels as ch0 - ch3, and set the input range for each channel to -10 - +10 V.  
(Gain = 0)
- Step 3. Set the sampling rate to 200 Hz, and set the scan mode to Mode2: Virtual Sample and Hold Mode. With Virtual Sample and Hold Mode, the sampling time interval between one channel and another channel is 4  $\mu$ s.
- Step 4. Collect 2000 samples, which means collecting 500 samples per channel. (i.e., 2000 divided by four channels). The elapsed time will be  $500 * (1/ 200 \text{ Hz}) = 2500 \text{ ms}$ .
- Step 5. If the system uses the MiniOS7 platform, converting the data from hexadecimal format to floating point format and then transferring it via the Ethernet will add to the CPU load. It is recommended that the hexadecimal data is first transferred to a PC client and then converted to floating point data on the PC.

Note: I-8014CW only can select max 8 channels and +/- 20 mA Input Range



If the system uses the Windows platform, converting data from hexadecimal format to floating point format will not affect the CPU load. The data can be converted to floating point format locally and then transferred via the Ethernet.

### Tips & Warnings



It is recommended that several buffers are created to process the data obtained from the FIFO, which can then be reused in the processing flow, as illustrated in the figure below. This allows the system time to convert the data, and then save and transfer it.

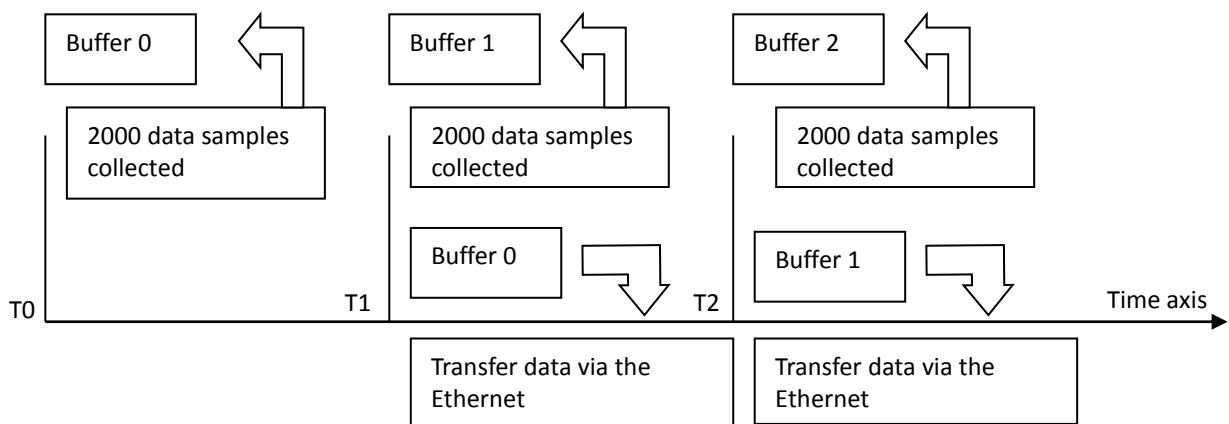

## 4. API References

ICPDAS supplies a range of C/C++ API functions for the I-9028U module. When developing a custom program, refer to either the 9028W.h header file, or the API functions described in the following sections for more detailed information.

ICPDAS also supplies a range of C# function that can be used to develop custom .NET programs. These functions are ported from the relevant C/C++ functions. For more information related to the .NET functions, refer to the pac\_i9028.cs file.

More details of where to find the relevant libraries and files, refer to Chapter 1.7 Location of the Demo and Library Programs.

The following is an overview of the functions provided in the 9028.lib for use with the 9000 PAC platform. Detailed information related to individual functions can be found in the following sections.

Function	Description
i8014W_Init	This function is used to initialize the driver and confirm the hardware ID.
i8014W_GetFirmwareVer_L1	This function is used to retrieve the version number of the primary FPGA firmware for a module.
i8014W_GetFirmwareVer_L2	This function is used to retrieve the version number of the secondary FPGA firmware for a module.
i8014W_GetLibVersion	This function is used to retrieve the version number of the 8014W.lib.
i8014W_GetLibDate	This function is used to retrieve the release date of the 8014W.lib.
i8014W_GetSingleEndJumper	This function is used to retrieve the single-ended/differential jumper position settings on the I-8014(C)W/I-9014(C).
i8014W_ReadGainOffset	This function is used to obtain the gain and offset values on each input type for I-8014W/I-9014.
i8014W_Read_mA_GainOffset	This function is used to obtain the gain and offset values on each input type for I-8014CW/I-9014C.
i8014W_ReadAI	This function is used to read a floating point input (calibrated) from one specified channel.

i8014W_ReadAIHex	This function is used to read a hexadecimal input (calibrated) from a single specified channel.
i8014W_ConfigMagicScan	This function is used to configure all the parameters needed when using Magic Scan, and should be called before executing any Magic Scan instructions.
i8014W_StartMagicScan	This function is used to start Magic Scan.
i8014W_StopMagicScan	This function is used to stop Magic Scan.
i8014W_ReadFIFO	This function is used to read data from the FIFO buffer after the Magic Scan function has been triggered.
i8014W_CalibrateData	This function is used to calibrate the raw data read during the Magic Scan process and to convert the data to a floating point value.
i8014W_CalibrateDataHex	This function is used to calibrate the raw data read in Magic Scan process.
i8014W_UnLockFIFO	This function is used to unlock the FIFO buffer when it is locked after being filled.
i8014W_ClearFIFO	This function is used to clear the FIFO buffer after the UnlockFIFO function has been executed.
i8014W_InstallMagicScanISR	This function is used to install the ISR to control to control interrupt events form the FIFO buffer.
i8014W_UnInstallMagicScanISR	This function is used to uninstall the Magic Scan ISR.
i8014W_ClearInt	This function is used to clear the status of the Magic Scan interrupts.

## 4.1. i8014W\_Init

This function is used to initialize the driver and confirm the hardware ID.

### Syntax

#### For MiniOS7

---

```
short i8014W_Init(int slot);
```

#### For Windows (CE and WES)

---

```
short pac_i8014W_Init(int slot);
```

### Parameter

*slot:*

specifies the slot number (0 - 7).

### Return Values

0 = the module in the slot is an I-8014(C)W/I-9014(C).

-1 = there is no I-8014(C)W/I-9014(C) module in this slot.

For other return values, see the [Appendix A. Error Code](#).

### Note

Before executing any functions on the I-8014(C)W/I-9014(C), the i8014W\_Init function needs to be called once for each I-8014(C)W/I-9014(C). If there are two or more I-8014(C)W/I-9014(C) modules, you need call the i8014W\_Init function for each I-8014(C)W/I-9014(C) module individually by passing the slot number that the I-8014(C)W/I-9014(C) module is plugged into.

## Example

[C/C++]

```
int slotIndex, err;
err=i8014W_Init(slotIndex);
if(err==0)
{
    printf("There is an I-8014W module in slot %d\n",slotIndex);
}
else
{
    printf("There is no I-8014W module in slot %d\n",slotIndex);
}
```

## 4.2. i8014W\_GetFirmwareVer\_L1

This function is used to retrieve the version number of the primary FPGA firmware for a module. The function is only used for troubleshooting or recording purposes.

### Syntax

#### For MiniOS7

```
short i8014W_GetFirmwareVer_L1(int slot);
```

#### For Windows (CE and WES)

```
short pac_i8014W_GetFirmwareVer_L1(int slot);
```

### Parameter

*slot:*

specifies the slot number (0 - 7).

### Return Values

The version number of the primary FPGA firmware for the I-8014(C)W/I-9014(C)module.

### Example

#### [C++]

```
short ver_L1=0, slot=0;  
ver_L1= i8014W_GetFirmwareVer_L1 (slot);  
printf( "\nPrimaryFPGA Version =: %04X",i8014W_GetFirmwareVer_L1(slot) );
```

### 4.3. i8014W\_GetFirmwareVer\_L2

This function is used to retrieve the version number of the secondary FPGA firmware for a module. The function is only used for troubleshooting or recording purposes.

#### Syntax

##### For MiniOS7

```
short i8014W_GetFirmwareVer_L2(int slot);
```

##### For Windows (CE and WES)

```
short pac_i8014W_GetFirmwareVer_L2(int slot);
```

#### Parameter

*slot:*

specifies the slot number (0 - 7).

#### Return Values

The version number of the secondary FPGA firmware for the I-8014(C)W/I-9014(C)module.

#### Example

##### [C++]

```
short ver_L2=0, slot=0;  
ver_L2= i8014W_GetFirmwareVer_L2 (slot);  
printf( "\nSecondaryFPGA Version =: %04X",i8014W_GetFirmwareVer_L2(slot) );
```

## 4.4. i8014W\_GetLibVersion

This function is used to retrieve the version number of the 8014W.lib. The function is only used for troubleshooting or recording purposes.

### Syntax

#### For MiniOS7

```
short i8014W_GetLibVersion(void);
```

#### For Windows (CE and WES)

```
short pac_i8014W_GetLibVersion(void);
```

### Parameter

None

### Return Values

The version number of the 8014W.lib.

### Example

#### [C++]

```
short version;  
version = i8014W_GetLibVersion();  
printf("\nLibrary Version =: %04X",i8014W_GetLibVersion());
```



## 4.5. i8014W\_GetLibDate

This function is used to retrieve the release date of the 8014W.lib. The function is only used for troubleshooting or recording purposes.

### Syntax

#### For MiniOS7

```
void i8014W_GetLibDate(char *LibDate);
```

#### For Windows (CE and WES)

```
void pac_i8014W_GetLibDate(char libDate[]);
```

### Parameter

*\*libDate:*

[Output] the release date of the 8014W.lib.

### Return Values

None

### Example

#### [C++]

```
charlibDate [32];  
i8014W_GetLibDate(libDate);  
printf("\nBuild Date =: %s",libDate);
```

## 4.6. i8014W\_GetSingleEndJumper

This function is used to retrieve the single-ended/differential jumper position settings on the I-8014(C)W/I-9014(C). If you wish to use 8-channel differential input, the jumper needs to be put in differential position; similarly, the jumper needs be set to the single-ended position before 16-channel single-ended input will works correctly.

### Syntax

#### For MiniOS7

---

```
short i8014W_GetSingleEndJumper(int slot);
```

#### For Windows (CE and WES)

---

```
short pac_i8014W_GetSingleEndJumper(int slot);
```

### Parameter

*slot:*

specifies the slot number (0 - 7).

### Return Values

0: The jumper is in the differential position.

1: The jumper is in the single-ended position.

## Example

[C++]

```
short jumper=0, maxCh=0;
jumper = i8014W_GetSingleEndJumper(slot);
if(jumper)
{
    maxCh=16;
    printf("i8014W Input Mode=Single-End\n\r");
}
else
{
    maxCh=8;
    printf("i8014W Input Mode=Differential\n\r");
}
```

## 4.7. i8014W\_ReadGainOffset

This function is used to obtain the gain and offset values on each input type for I-8014W/I-9014C. I-8014CW/I-9014C can use i8014W\_Read\_mA\_GainOffset function. Please refer to section 4.1.8.

### Syntax

#### For MiniOS7

```
void i8014W_ReadGainOffset
(
    int slot,
    int gain,
    unsigned short* gainValue,
    short* offsetValue
);
```

#### For Windows (CE and WES)

```
void pac_i8014W_ReadGainOffset
(
    int slot,
    short gain,
    unsigned short* gainValue,
    short* offsetValue
);
```

### Parameter

*slot:*

specifies the slot number (0 - 7).

*gain:*

specifies the input type (0 - 4), where: 0: +/-10 V, 1: +/-5 V, 2: +/-2.5 V, 3: +/-1.25 V, 4: +/-20 mA

*\*gainValue:*

[Output] the gain value for the input range.

*\*offsetValue:*

[Output] the offset value for the input range.

## Return Values

None

## Example

[C++]

```
unsigned short gVal=0;
short oVal=0;
i8014W_ReadGainOffset(slot,gain,&gVal,&oVal);
printf("\nThe Gain and Offset values for Calibration are: Gain=%u; Offset=%d",ch,gVal,oVal);
```

## 4.8. i8014W\_Read\_mA\_GainOffset

This function is used to obtain the gain and offset values on each input type for I-8014CW/I-9014C. I-8014W/I-9014 can use i8014W\_ReadGainOffset function. Please refer to section 4.1.7.

### Syntax

#### For MiniOS7

```
void i8014W_Read_mA_GainOffset
(
    int slot,
    int channel,
    unsigned short* gainValue,
    short* offsetValue
);
```

#### For Windows (CE and WES)

```
voidpac_i8014W_Read_mA_GainOffset
(
    int slot,,
    int channel,
    unsigned short* gainValue,
    short* offsetValue
);
```

### Parameter

*slot:*

specifies the slot number (0 - 7).

*channel:*

specifies the channel (0 - 7), for +/-20 mA

*\*gainValue:*

[Output] the gain value for the input range.

*\*offsetValue:*

[Output] the offset value for the input range.

## Return Values

None

## Example

[C++]

```
unsigned short gVal=0;
short oVal=0;
i8014W_Read_mA_GainOffset (slot,ch,&gVal,&oVal);
printf("\nThe channel and Offset values for Calibration are: Gain=%u; Offset=%d",ch,gVal,oVal);
```

## 4.9. i8014W\_ReadAI

This function is used to read a floating point input (calibrated) from one specified channel.

### Syntax

#### For MiniOS7

```
short i8014W_ReadAI(  
    int slot,  
    intch,  
    int gain,  
    float* fVal  
);
```

#### For Windows (CE and WES)

```
short pac_i8014W_ReadAI(  
    int slot,  
    shortch,  
    short gain,  
    float* fVal  
);
```

### Parameter

*slot:*

specifies the slot number (0 - 7).

*ch:*

specifies the channel number, 0 - 7 for differential input, or 0 - 15 for single-ended input.

*gain:*

specifies the input type (0 - 4), where: 0: +/-10 V, 1: +/-5 V, 2: +/-2.5 V, 3: +/-1.25 V, 4: +/-20 mA

*\*fVal:*

[Output] the floating-point data.



## Return Values

0 = No Error

For other return values, see the [Appendix A. Error Code](#).

## Example

[C++]

```
intslot,ch,gain;
floatfVal=0.0;

slot = 0;
gain = 0; // "+/-10V"
for(ch=0;ch<8;ch++)
{
    i8014W_ReadAI( slot, ch, gain, &fVal);
    printf("\n[%02d]= [ %05.4f ]",ch,,fVal);
}
```

## Note

I-8014CW/I-9014C only can select max 8 channels and +/- 20 mA Input Range

## 4.10. i8014W\_ReadAIHex

This function is used to read a hexadecimal input (calibrated) from a single specified channel.

### Syntax

#### For MiniOS7

```
short i8014W_ReadAIHex(  
    int slot,  
    int ch,  
    int gain,  
    short* hVal  
);
```

#### For Windows (CE and WES)

```
short pac_i8014W_ReadAIHex(  
    int slot,  
    short ch,  
    short gain,  
    short* hVal  
);
```

### Parameter

*slot:*

specifies the slot number (0 - 7).

*ch:*

specifies the channel number, 0 - 7 for differential input, or 0 - 15 for single-ended input.

*gain:*

specifies the input type (0 - 4), where: 0: +/-10 V, 1: +/-5 V, 2: +/-2.5 V, 3: +/-1.25 V, 4: +/-20 mA

*\*hVal:*

[Output] the hexadecimal data.

## Return Values

0 = No Error

For other return values, see the [Appendix A. Error Code](#).

## Example

[C++]

```
intslot,ch,gain;
shorthVal=0.0;

slot = 0;
gain = 0; // "+/-10V"
for(ch=0;ch<8;ch++)
{
    i8014W_ReadAIHex( slot, ch, gain, &hVal);
    printf("\n[%02d]= [ %04X ] ",ch,,hVal);
}
```

## Note

I-8014CW/I-9014C only can select max 8 channels and +/- 20 mA Input Range

## 4.11. i8014W\_ConfigMagicScan

This function is used to configure all the parameters needed when using Magic Scan, and should be called before executing any Magic Scan instructions.

### Syntax

#### For MiniOS7

---

```
void i8014W_ConfigMagicScan
(
    int slot,
    intchArr[],
    intgainArr[],
    intscanChCount,
    floatsampleRate,
    intscanMode,
    intrtriggerSource,
    intrtriggerState ,
    float* realSampleRate
);
```

#### For Windows (CE and WES)

---

```
void pac_i8014W_ConfigMagicScan
(
    int slot,
    shortchArr[],
    shortgainArr[],
    shortscanChCount,
    floatsampleRate,
    shortscanMode,
    shorttriggerSource,
    shorttriggerState,
    float* realSampleRate
);
```

## Parameter

*slot:*

specifies the slot number (0 - 7)

*chArr[]:*

creates an array that is used to set the channels to be scanned. The channel indices define the scanning order; the maximum number of channels is 16.

*gainArr[]:*

creates an array that is used to set the input type for the corresponding channel with the same index as that stored in *chArr[]*, where: 0: +/-10 V, 1: +/-5 V, 2: +/-2.5 V, 3: +/-1.25 V, 4: +/-20 mA

*scanChCount:*

a count of the channels, that have been added to *chArr[]*.

*sampleRate:*

the total sampling rate, 2 - 250 kHz.

*scanMode:*

- 1: Standard mode
- 2: Virtual Sample and Hold mode

*triggerSource:*

- 0: Software trigger
- 1: Internal hardware trigger
- 2: External hardware trigger

*triggerState:*

- 0: Rising edge trigger. This is only valid when using an external hardware trigger.
- 1: Falling edge trigger. This is only valid when using an external hardware trigger.

*\*realSampleRate:*

[Output] the real sampling rate that was used by the I-8014W.

## Return Values

None

## Example

[C++]

```
int slot, chArr[16], gainArr[16], scanChCount;
float sampleRate, realSampleRate;
int scanMode, triggerSource, triggerState;
slot = 0;
chArr[0]=0; // element 0 assigned to channel 0
chArr[1]=1;
...
chArr[15]=15; // element 15 assigned to channel 15
gainArr[0]=0; // element 0 assigned to input type 0
gainArr[1]=1; // element 1 assigned to input type 1
...
gainArr[15]=4; // element 15 assigned to input range 4
scanChCount=1; //only sample chArr[0] (channel 0 )
sampleRate=25000.0; //set the sample rate to 25 KHz
scanMode=1; // use M1 standard mode
triggerSource=1; // use internal interrupt signal Mode
triggerState=0;

realSampleRate=i8014W_ConfigMagicScan(slotIndex,chArr,gainArr,scanChCount, sampleRate,
scanMode,triggerSource,triggerState);
printf ("Set Sample Rate = %6.3f   Real Sample Rate = %6.3f \n",sampleRate, realSampleRate);

i8014W_StartMagicScan(slot);
...
i8014W_ReadFIFO();
```

## Note

I-8014CW/I-9014C only can select max 8 channels and +/- 20 mA Input Range

## 4.12. i8014W\_StartMagicScan

This function is used to start Magic Scan. Once Magic scan starts, the converted data is immediately saved to the FIFO buffer. When an external hardware trigger is selected, after this function is executed, the I-8014(C)W/I-9014(C) will wait until it receives a trigger signal.

If you wish to simultaneously initial Magic Scan on two or more I-8014(C)W/I-9014(C) modules using an internal hardware trigger source, configure each module and then execute the StartMagicScan function only once. The slot number can be any of the slots that contain an I-8014(C)W/I-9014(C) modules.

### Syntax

#### For MiniOS7

```
short i804W_StartMagicScan(int slot);
```

#### For Windows (CE and WES)

```
short pac_i8014W_StartMagicScan(int slot);
```

### Parameter

*slot:*

specifies the slot number (0 - 7).

### Return Values

0 = No Error

For other return values, see the [Appendix A. Error Code](#).

### Example

[C++]

```
int slot;  
slot=0;  
i804W_StartMagicScan(slot);
```

## 4.13. i8014W\_StopMagicScan

This function is used to stop Magic Scan. All operations for saving data to the FIFO buffer are also stopped because no further data will be converted.

### Syntax

#### For MiniOS7

```
short i804W_StopMagicScan(int slot);
```

#### For Windows (CE and WES)

```
short pac_i8014W_StopMagicScan(int slot);
```

### Parameter

*slot:*

*specifies the slot number (0 - 7).*

### Return Values

0 = No Error

For other return values, see the [Appendix A. Error Code](#).

### Example

[C++]

```
int slot;  
slot = 0;  
i804W_StopMagicScan (slot);
```



## 4.14. i8014W\_ReadFIFO

This function is used to read data from the FIFO buffer after the Magic Scan function has been triggered. If the amount of data in the FIFO buffer is less than the value set using the readCount parameter, the function will read all the data and return it immediately. You will then need to reset the hexData [ ] and readCount parameters and continue to call this function until all the data required is obtained and then stop Magic Scan.

### Syntax

#### For MiniOS7

```
short i804W_ReadFIFO
(
    int slot,
    shorthexData[],
    shortreadCount,
    short* dataCountFromFIFO
);
```

#### For Windows (CE and WES)

```
short pac_i8014W_ReadFIFO
(
    int slot,
    shorthexData[],
    shortreadCount,
    short* dataCountFromFIFO
);
```

## Parameter

*slot:*

specifies the slot number (0 - 7).

*hexData []:*

specifies the starting address of the data array used to store the data that is read in hexadecimal format..

*readCount:*

specifies the amount of data required.

\* *dataCountFromFIFO:*

[Output] the amount of data read in this process.

## Return Values

0 = No Error

For other return values, see the [Appendix A. Error Code](#).

## Example

[C++]

```
int slot;
shorthexData[8192];
longreadCnt=0;
shorttotalScaned=0;
shortTargetCnt=1000;
slot = 0;
i8014W_ReadFIFO(slot,hexData+totalScaned, TargetCnt-totalScaned,&readCnt);
if(readCnt>0)
totalScaned+=readCnt;
if(readCnt==MAX_FIFO || totalScaned>=TargetCnt)
{
    i8014W_StopMagicScan(slot);
    i8014W_UnLockFIFO(slot);
    i8014W_ClearFIFO(slot);
}
```

## 4.15. i8014W\_CalibrateData

This function is used to calibrate the raw data read during the Magic Scan process and to convert the data to a floating point value.

### Syntax

#### For MiniOS7

```
void i8014W_CalibrateData
(
    int slot,
    shortiGain,
    shortdataFromFIFO,
    float* calibratedAI
);
```

#### For Windows (CE and WES)

```
void pac_i8014W_CalibrateData
(
    int slot,
    shortiGain,
    shortdataFromFIFO,
    float* calibratedAI
);
```

### Parameter

*slot:*

specifies the slot number (0 - 7).

*iGain:*

specifies the input type (0 - 4), where:0: +/-10 V, 1: +/-5 V, 2: +/-2.5 V, 3: +/-1.25 V, 4: +/-20 mA

*dataFromFIFO:*

the raw data read from the FIFO buffer.

\* *calibratedAI:*

[Output] the floating point value.

## Return Values

None

## Example

[C++]

```
int slot;
int i;
floatcalibratedAI=0;
printf("Start printing all the data:\n\n\r");
for(i=0;i<totalScaned;i++);
{
    slot = 0;
    i8014W_CalibrateData(slotIndex,
    gainArr[i %scanChCount],hexData[i], &calibratedAI);
    printf("Arr[%d]=[%5.4f]\t",i%scanChCount,calibratedAI);
}
```

## 4.16. i8014W\_CalibrateDataHex

This function is used to calibrate the raw data read in Magic Scan process.

### Syntax

#### For MiniOS7

```
void i8014W_CalibrateDataHex  
(  
    int slot,  
    shortiGain,  
    shortdataFromFIFO,  
    short* calibratedAI  
);
```

#### For Windows (CE and WES)

```
void pac_i8014W_CalibrateDataHex  
(  
    int slot,  
    shortiGain,  
    shortdataFromFIFO,  
    short* calibratedAI  
);
```

### Parameter

*slot:*

specifies the slot number (0 - 7).

*iGain:*

specifies the input type (0 - 4), where:0: +/-10 V, 1: +/-5 V, 2: +/-2.5 V, 3: +/-1.25 V, 4: +/-20 mA

*dataFromFIFO:*

the raw data read from the FIFO buffer.

*\* calibratedAI :*

[Output] the calibrated hexadecimal value.

## Return Values

None

## Example

### [C++]

```
int slot;
int i;
floatcalibratedAI=0;
printf("Start printing all the data:\n\n\r");
for(i=0;i<totalScaned;i++);
{
    slot = 0;
    i8014W_CalibrateDataHex (slotIndex,
    gainArr[i %scanChCount],hexData[i], &calibratedAI);
    printf("Arr[%d]=[ %#x]\t",i,%scanChCount,calibratedAI);
}
```

## 4.17. i8014W\_UnLockFIFO

This function is used to unlock the FIFO buffer when it is locked after being filled. Ensure that the FIFO buffer is unlocked and cleared before starting the next Magic Scan process.

### Syntax

#### For MiniOS7

```
void i804W_UnLockFIFO (int slot);
```

#### For Windows (CE and WES)

```
void pac_i8014W_UnLockFIFO(int slot);
```

### Parameter

*slot:*

specifies the slot number (0 - 7).

### Return Values

None

### Example

[C++]

```
int slot;  
slot = 0;  
i804W_UnLockFIFO (slot);
```

## 4.18. i8014W\_ClearFIFO

This function is used to clear the FIFO buffer after the UnlockFIFO function has been executed. Ensure that the FIFO buffer is unlocked and cleared before starting the next Magic Scan process.

### Syntax

#### For MiniOS7

```
void i804W_ClearFIFO (int slot);
```

#### For Windows (CE and WES)

```
void pac_i8014W_ClearFIFO(int slot);
```

### Parameter

*slot:*

specifies the slot number (0 - 7).

### Return Values

None

### Example

[C++]

```
int slot;  
slot = 0;  
i804W_ClearFIFO (slot);
```



## 4.19. i8014W\_InstallMagicScanISR

This function is used to install the ISR to control to control interrupt events form the FIFO buffer. When the amount of data in the FIFO buffer is greater than the value defined by the triggerLevel parameter (as per the table below), an interrupt event will occurs and the ISR will be executed to handle the event. In the ISR, use the ReadFIFO to transfer data from the FIFO buffer and then ClearInt to restart the status of the interrupt.

### Syntax

#### For MiniOS7

```
short i804W_InstallMagicScanISR
(
    int slot,
    void (*isr)
    (int slot),
    inttriggerLevel
);
```

#### For Windows (CE and WES)

```
short pac_i8014W_InstallMagicScanISR
(
    int slot,
    void(*isr)
    (int slot),
    shorttriggerLevel
);
```

## Parameter

*slot:*

specifies the slot number (0 - 7).

*\*isr (int slot):*

the function pointer passed for the ISR.

*triggerLevel:*

specifies the interrupt trigger condition (0 - 7) based on the amount of data in the FIFO buffer. If the value is set to greater than 7, it will be automatically forced to 7.

If the amount of data in the FIFO buffer is greater than the value defined by the triggerLevel parameter, the interrupt will be triggered and the ISR will be executed to handle the interrupt event.

The following is a definition of the triggerLevelvalues table lists the definition of triggerLevel and associated Data Count values:

triggerLevel	Data Count
0	8
1	16
2	32
3	64
4	128
5	256
6	512
7	2048

## Return Values

0 = No Error

For other return values, see the [Appendix A. Error Code](#).

## Example

```
[C++]
void main()
{
    intslot,TrgLevel;
    slot = 0;
    TrgLevel=100;
    i8014W_Install_MagicScanISR(slot,ISRFUN, TrgLevel);
    i8014W_ConfigMagicScan(...);

    i8014W_StartMagicScan(slot);
    ...
    while(1)
    {
        if(IntCnt>1)
        {
            i8014W_UnInstall_MagicScanISR(slot);
            break;
        }
    }
    ...
}

voidISRFUN(int slot);
{
    IntIntCnt=0;
    IntCnt++;
    ret=i8014W_ReadFIFO(slot, hexData+totalScaned,
    TargetCnt-totalScaned,&readCnt);
    if(readCnt>0)
    {
        totalScaned+=readCnt;
        printCom1("TotalScaned= %d\n\r",totalScaned);
        totalRead+=readCnt;
    }
    i8014W_ClearInt(slot);
}
```

## 4.20. i8014W\_UnInstallMagicScanISR

This function is used to uninstall the Magic Scan ISR.

### Syntax

#### For MiniOS7

```
short i804W_UnInstallMagicScanISR(int slot);
```

#### For Windows (CE and WES)

```
short pac_i8014W_UnInstallMagicScanISR(int slot);
```

### Parameter

*slot:*

specifies the slot number (0 - 7).

### Return Values

0 = No Error

For other return values, see the [Appendix A. Error Code](#).

### Example

#### [C++]

```
int slot;  
slot = 0;  
i804W_UnInstallMagicScanISR (slot);
```

## 4.21. i8014W\_ClearInt

This function is used to clear the status of the Magic Scan interrupts. When using ISR, this function should be called to clear the status of any interrupts that have been triggered in order to continue processing future interrupt events.

### Syntax

#### For MiniOS7

```
void i804W_ClearInt (int slot);
```

#### For Windows (CE and WES)

```
void pac_i8014W_ClearInt(int slot);
```

### Parameter

*slot:*

specifies the slot number (0 - 7).

### Return Values

None

### Example

[C++]

```
int slot;  
slot = 0;  
i804W_StopMagicScan (slot);
```

## 5. Troubleshooting

This chapter discusses how to solve any problems you may encounter.

This chapter contains:

- How to verify the AI function on a WinCE or WES unit(See section 5.1)
- Service/Request Requirements (See section 5.2)
- What to do when the data read from I-8014W seems unstable(See section 5.3)
- How to solve the FIFO LATCHED error (-6) (See section 5.4)

## 5.1. How to verify the AI function on a WinCE or WES unit

If the data read from the I-8014W is inconsistent with the input signal, and you would like to confirm the input function, `pac_i8014W_UTILITY.exe` may be helpful. The utility can only be used with I-8014W module for the WinCE and WES platform controller and is located in the I-8014W C # demo program folder for the controller. (See the Location of the Demo Programs section on page 12)

Step 1. Connect a stable signal to the I-8014W module.

- a. Connect your input signal according whether differential or single-ended Jumper settings are used. (See the Jumper Settings section on page 8)
- b. The input range can be from +10 V to -10 V.
- c. Insert the I-8014W into a slot in a Windows platform controller and then turn on the controller.

---

### Tips & Warnings



1. A battery output should provide a stable enough signal.
2. A 125 Ohm resistor is required when measuring current input.
3. When measuring the voltage using differential input type, if the result is not as stable as the input signal, it is recommended that an additional is connected between the Vn- and the AGND (analog ground pin) to enhance the accuracy. When measuring current input, this method has no benefit in enhancing accuracy.

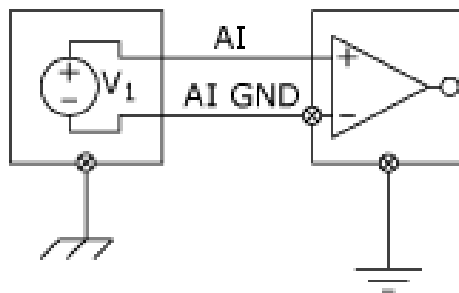

---

Step 2. Launch the `pac_i8014W_UTILITY.exe`

- Step 3. Read the information from the I-8014W module
- Form the I-8014W slot index drop-down list, select the slot that the I-8014W is connected to.
  - Click the Basic Information tab.

The Basic Information page includes:

- The version numbers for the 8014W.lib, the primary FPGA firmware (Firmware 1) and the secondary FPGA firmware (Firmware 2)
- The current position of the single-ended/ differential jumper
- The gain and offset values for each input type

Click the Save button to save all the information to Slot1\_8014W\_Info.txt file file. The information is useful for troubleshooting when service is requested.

Input Type	Gain	Offset
+/- 10V	32833	-39
+/- 5V	32831	-43
+/- 2.5V	32826	-52
+/- 1.25V	32665	-51
+/- 20mA	32826	-52

### Verifying the Gain and Offset Values

In a normal situation, the gain value should be around 33000. If the value is greatly different from 33000, it means that the value is incorrect. To correct this situation, try the following:

- Press **Refresh** to retrieve the gain values again and confirm whether or not they are correct.
- Relocate the I-8014W to a different slot, and then repeat Steps 2 and 3 to confirm whether or not the gain values are correct.

Note: I-8014CW only can select max 8 channels and +/- 20 mA Input Range



Step 4. Test the input function.

- a. Click the **AI test** tab, and then select the required input range from the Gain drop-down list.
- b. Enter the required sample count, and choose the data format from the format drop-down list.
- c. Click the **Start** button.

	First Data	Min Data	Max Data	Delta		First Data	Min Data	Max Data	Delta
C0	02.6645	02.6636	02.6651	00.0015	C8				
C1	02.6642	02.6636	02.6651	00.0015	C9				
C2	02.6642	02.6639	02.6648	00.0009	C10				
C3	02.6642	02.6639	02.6651	00.0012	C11				
C4	02.6642	02.6636	02.6651	00.0015	C12				
C5	02.6642	02.6639	02.6648	00.0009	C13				
C6	02.6642	02.6636	02.6651	00.0015	C14				
C7	02.6642	02.6639	02.6651	00.0012	C15				

Note: I-8014CW only can select max 8 channels and +/- 20 mA Input Range

After the sampling process is completed, the data will be displayed in the respective columns for each channel.

- d. If necessary, click the Save button to save the data and the sampling time to the **SampleData\_Hex\_mm\_dd\_hh\_mim\_sec.csv** file.

## 5.2. Service/Request Requirements

If you are using a stable signal source such as a battery to output a signal to the I-8014W module and are getting incorrect or unstable data, prepare the following three items and e-mail them to [service@icpdas.com](mailto:service@icpdas.com).

- The image of the physical wiring
- The file saved from the Basic Information tab (See section 5.1, step 3)
- The file saved from the AI Test tab (See section 5.1, step 4)

### 5.3. What to do when the data read from I-8014W seems unstable

If the voltage can be measured correctly when testing using a battery, but not when using the real signal source, the error may be caused by any or all of the following factors:

- A noise-corrupted signal source
- Instability in the signal source
- A floating signal source that is not referenced to a system ground (earth or building ground)

Because of the high-speed data acquisition function of the I-8014W, any noise coupled to a signal or any change in voltage on an unstable source is also captured. In this situation, signal filtering or isolation should be considered in order to enhance the quality of the signal.

It is recommended that the V- pin is connected to the AGND (system ground) pin when measuring differential signals, as shown in the figure.

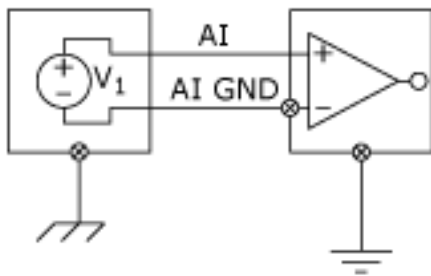

## 5.4. How to solve the FIFO LATCHED error (-6)

After the **StartMagicScan** instruction is executed, it will continue scanning the channels and converting data unless the **StopMagicScan** command is executed. Consequently, the converted data is continuously saved to the FIFO buffer. If the Magic Scan is not stopped after obtaining the required data, or the data is not read from the FIFO buffer within the required time frame, the FIFO buffer will be filled and then locked. When the FIFO buffer is locked, the FIFO LATCHED error (-6) will occur and any new data will not be able to be saved to the FIFO buffer.

To solve this error, execute the following instructions:

1. Stop Magic Scan using the **StopMagicScan** function.
2. Read the remaining data in the FIFO buffer using the **ReadFIFO** function, or clear it using the **ClearFIFO** function.
3. Unlock the FIFO buffer using the **UnlockFIFO** function.
4. Restart Magic Scan using the **StartMagicScan** function.

## Appendix A. Error Code

Error Code	Definition	Description
0	NoError	This indicates that there have been no errors
-1	ID_ERROR	There was a problem with the module ID
-2	SLOT_ERROR	There was a Slot index error (0 - 7)
-3	CHANNEL_ERROR	There was a Channel index error (0 - 15)
-4	GAIN_ERROR	There was a Gain error (0 - 4)
-5	FIFO_EMPTY	There is no data in the FIFO buffer
-6	FIFO_LATCHED	The FIFO buffer is full and has been latched
-7	FIFO_OVERFLOW	The FIFO buffer is full
-8	TX_NOTREADY	There was an error between the primary FPGA and the secondary FPGA

## Appendix B. Revision History

This chapter provides revision history information to this document.

The table below shows the revision history.

Revision	Date	Description
1.0.0	January 2018	Initial issue