

HART Solutions

- XP-8xx7-CE6
- WP-8xx7
- VP-2xW7

- Support I-87H17W modules to communicate with other HART Devices. ([FAQ-136](#))

ICP DAS HART Solutions for the ISaGRAF PAC

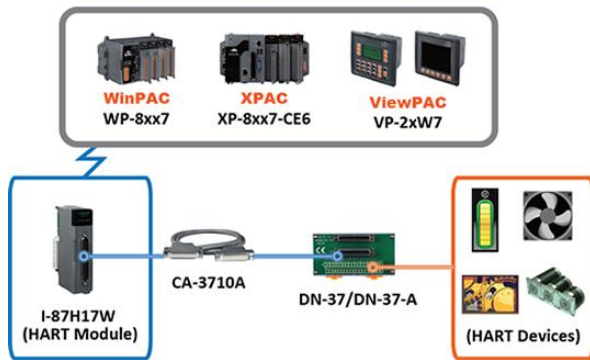

Database Application

- XP-8xx7-CE6
- WP-8xx7
- VP-2xW7

- Support SQL Client functions ([FAQ-135](#))

ICP DAS WinCE PAC Support SQL Server Communication Application

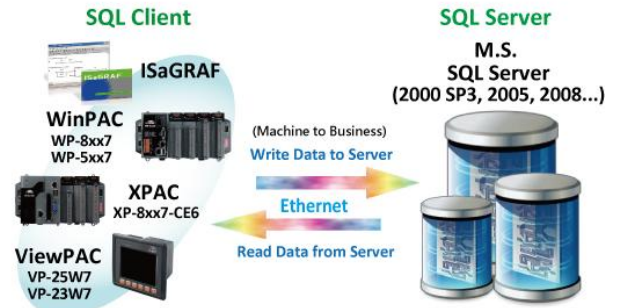

Motion Control: Using I-8094F/8092F/8094

- XP-8xx7-CE6
- WP-8xx7
- VP-2xW7

- Achieve HMI design, I/O control and motion control within the ISaGRAF software. ([FAQ-132](#))



Soft-GRAF : Create A Colorful HMI

- XP-8xx7-CE6
- WP-8xx7
- VP-2xW7

- Design the control logic and HMI by single ISaGRAF software ([FAQ-131](#))



Connect Intelligent Power Meter PM-2133/2134

- XP-8xx7-CE6
- WP-8xx7
- VP-2xW7

- For various control/monitor systems about intelligent electric power measurement. ([FAQ-129](#))

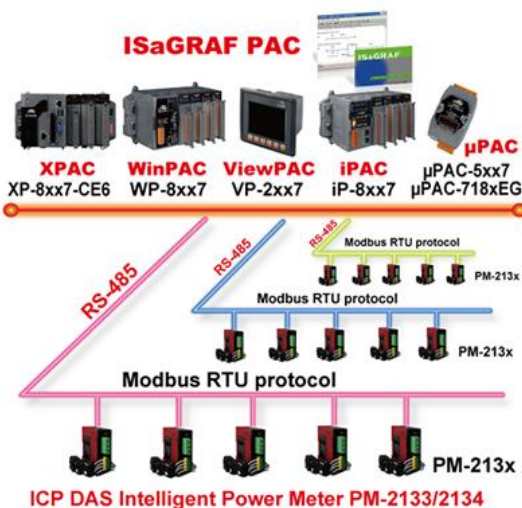

Stress Monitoring Application of Constructions

- XP-8xx7-CE6
- WP-8xx7
- VP-2xW7

- Both "VW Sensor" (Vibration Wire solution) and "Carlson Strain Gauge Inputs" solutions are useful for measuring the stress of constructions like building, bridge, dam, etc. ([FAQ-091](#), [128](#))

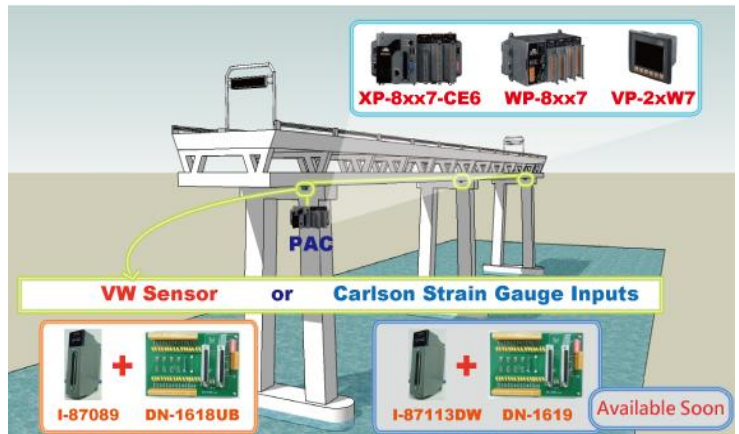

eLogger HMI Application

- XP-8xx7-CE6
- WP-8xx7
- VP-2xW7

- An easy and useful HMI development tool which helps user to create user-friendly pictures & control items. ([FAQ-115](#))

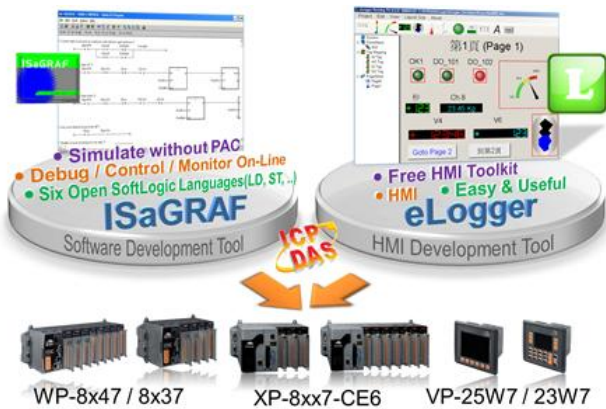

Redundant Communication System

- XP-8xx7-CE6
- WP-8xx7
- VP-2xW7

- ([FAQ-119](#))

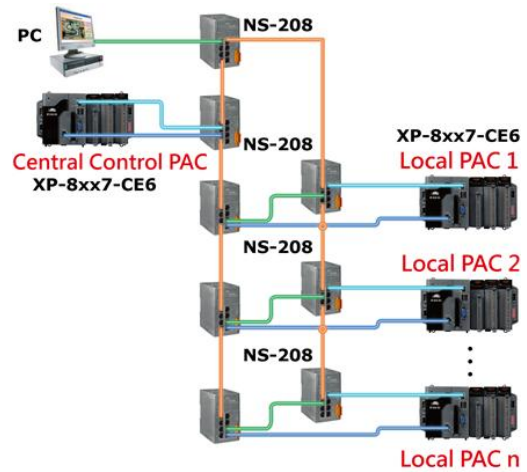

Redundant System with iDCS-8000

- XP-8xx7-CE6
- WP-8xx7
- VP-2xW7

- Dual PACs, dual Ethernet ports redundant ([FAQ-125](#))

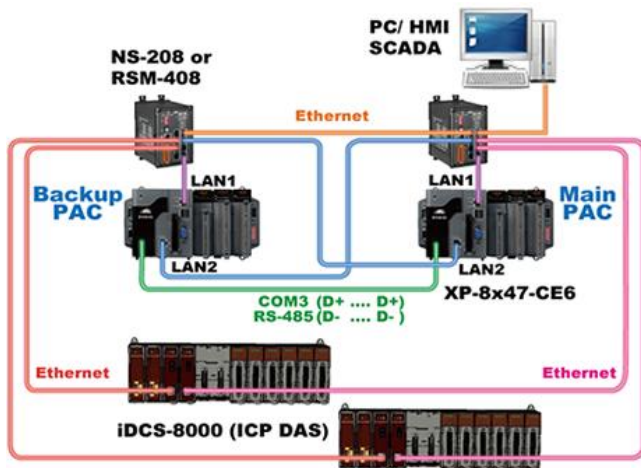

iDCS-8000 : I/O can be ET-7000 series or other Modbus TCP Slave devices

Redundant System with Ethernet I/O

- XP-8xx7-CE6
- WP-8xx7
- VP-2xW7

- The scan of Ethernet I/O is much faster than that of RS-485 I-7000 or I-87K I/O. ([FAQ-125](#))

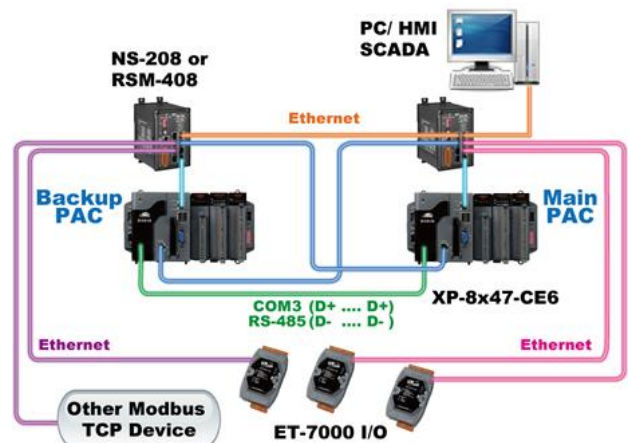

Redundant System with RS-485 I/O

- XP-8xx7-CE6
- WP-8xx7
- VP-2xW7

- Hot Swap I/O. (Apply to RU-87P1/2/4/8 with I-87K High profile I/O cards only) ([FAQ-093](#), [125](#), [138](#))

WP-8x47 or XP-8xx7-CE6 Redundant System with RS-485 I/O

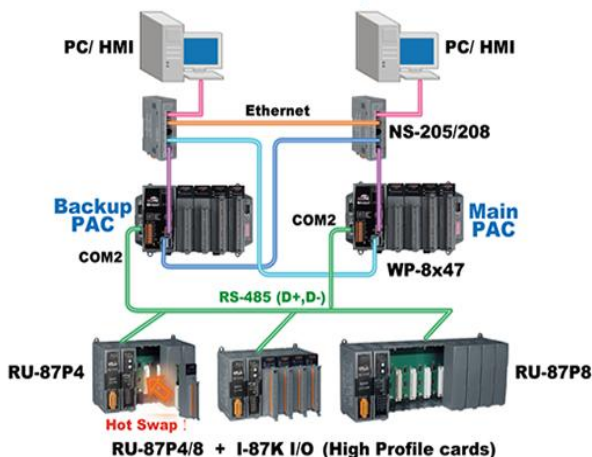

Modbus TCP/IP Master

- XP-8xx7-CE6
- WP-8xx7
- VP-2xW7

- Support to link to max. 100 Modbus TCP/IP slave devices. ([FAQ-113](#))

Modbus TCP/IP Master Application

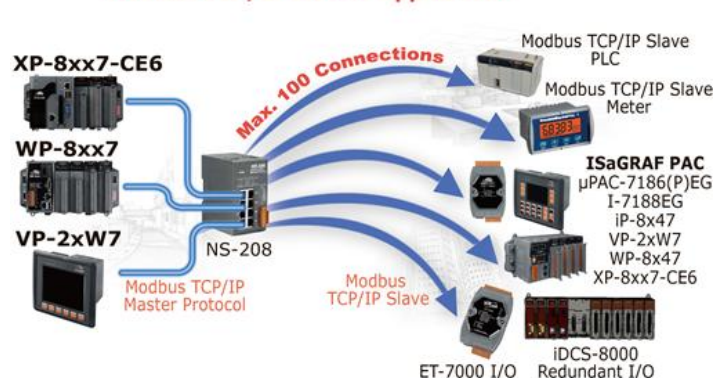

ZigBee Wireless Solution

- XP-8xx7-CE6
- WP-8xx7
- VP-2xW7

- Reduce the wiring cost, and achieve the mission of remote I/O control and data acquisition. ([FAQ-110](#))

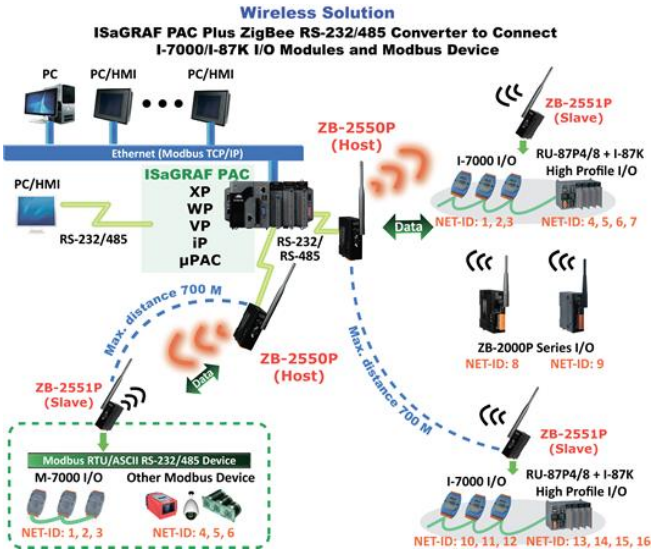

GPS Applications: With I-87211W or GPS-721

- XP-8xx7-CE6
- WP-8xx7
- VP-2xW7

- For doing auto-time-synchronization and getting local Longitude and Latitude. ([FAQ-107](#))

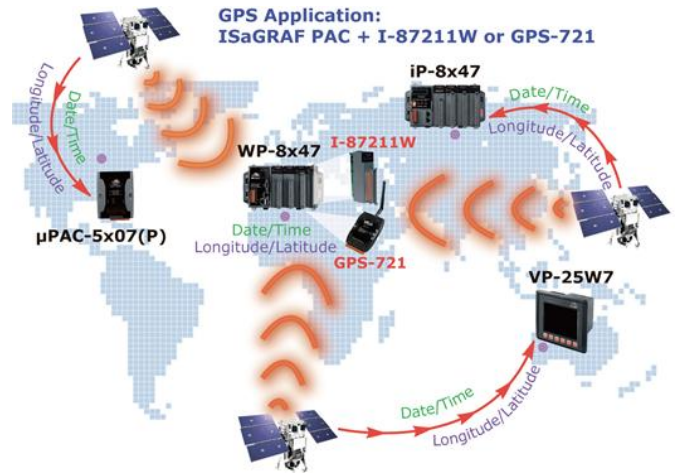

Integrate with CAN/CANopen Devices and Sensors

- XP-8xx7-CE6
- WP-8xx7
- VP-2xW7

- ([FAQ-086](#))

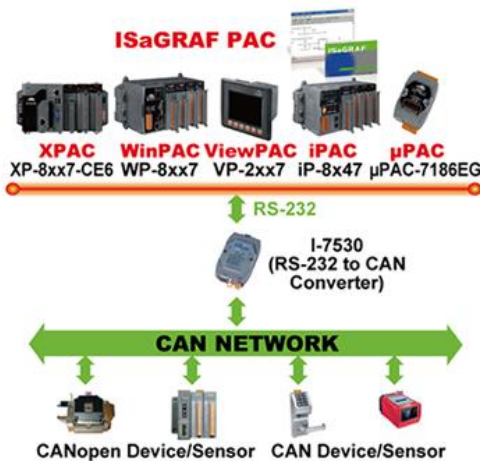

Send Email with One Attached File

- XP-8xx7-CE6
- WP-8xx7
- VP-2xW7

- The maximum file size is about 488K bytes. One Email can send to 10 receivers at one sending. ([FAQ-067, 077](#))

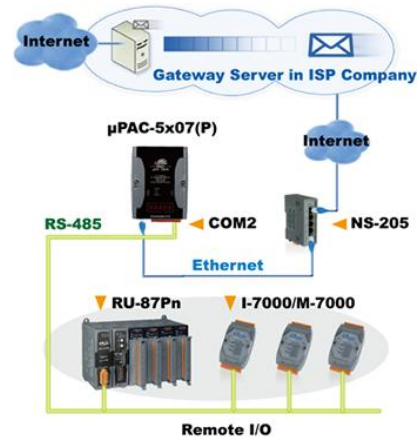

Fast FRnet Remote I/O Modules

- XP-8xx7-CE6
- WP-8xx7
- VP-2xW7

- ([FAQ-082](#))

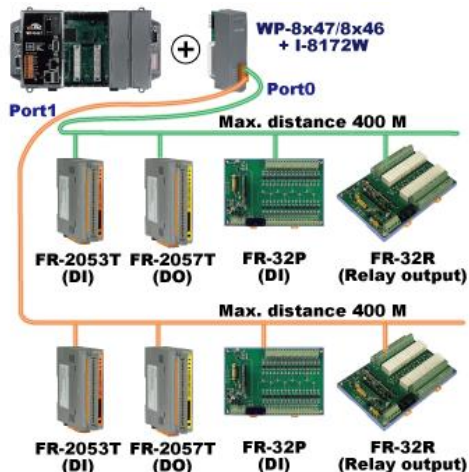

Data Acquisition Auto-Report System

- XP-8xx7-CE6
- WP-8xx7
- VP-2xW7

- Advantage: Each PAC in the different location doesn't require a fixed Internet IP. ([FAQ-065](#))

Stable and Cost-effective Data Acquisition Auto-Report System

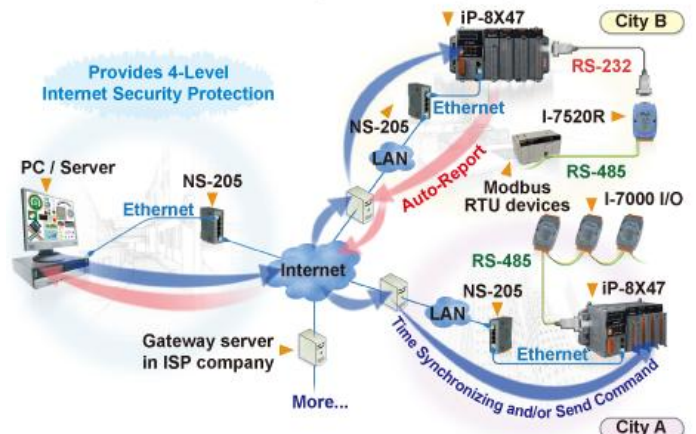

Modbus RTU/TCP Slave Ports

<input checked="" type="checkbox"/> XP-8xx7-CE6	<input checked="" type="checkbox"/> WP-8xx7	<input checked="" type="checkbox"/> VP-2xW7
---	---	---

- Modbus RTU(RS-232/485/422) : Max. **9** PC/HMI/SCADA connections
 XP-8xx7-CE6 : Max. **9** Modbus RTU Slave ports
 WP-8x37/8x47: Max. **5** Modbus RTU Slave ports
 VP-2xW7: Max. **5** Modbus RTU Slave ports
- Modbus TCP/IP : Max. **64** PC/HMI/SCADA connections
 XP-8xx7-CE6: Max. **64** Modbus RTU Slave ports
 WP-8x37/8x47: Max. **32** Modbus TCP Slave connections
 VP-2xW7: Max. **32** Modbus TCP Slave connections

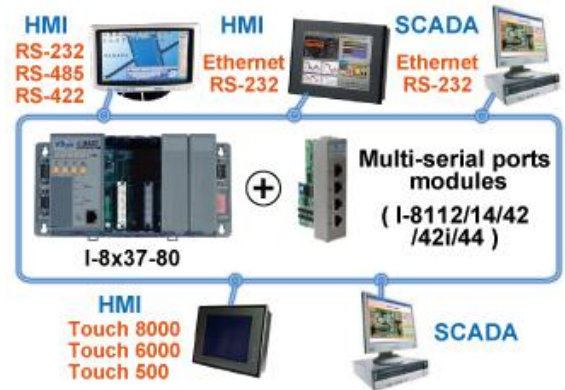

Modbus RTU/ASCII Master Ports

<input checked="" type="checkbox"/> XP-8xx7-CE6	<input checked="" type="checkbox"/> WP-8xx7	<input checked="" type="checkbox"/> VP-2xW7
---	---	---

- Modbus RTU/ASCII (RS-232/485/422):
 Max. **33** Modbus device connections
 XP-8xx7-CE6: Max. **33** Modbus RTU Master ports
 WP-8xx7: Max. **10** Modbus RTU Master ports
 VP-2xW7: Max. **10** Modbus RTU Master ports

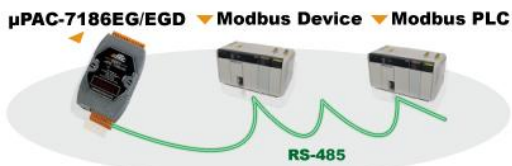

SMS: Short Message Service

<input checked="" type="checkbox"/> XP-8xx7-CE6	<input checked="" type="checkbox"/> WP-8xx7	<input checked="" type="checkbox"/> VP-2xW7
---	---	---

- Integrate with a GSM Modem to support SMS: Short Message Service. This allows user to request information or perform control tasks for the ISaGRAF PAC via his personal cellular phone. In addition, the controller can also send information and alarms to user's cellular phone.
- The short message can be sent in multiple language format ([FAQ-111](#))



Remote I/O Modules and Expansion module/board

<input checked="" type="checkbox"/> XP-8xx7-CE6	<input checked="" type="checkbox"/> WP-8xx7	<input checked="" type="checkbox"/> VP-2xW7
---	---	---

- XP-8xx7-CE6 (add COM6~33), WP-8xx7 & VP-2xW7 (add COM5~14) support RS-232/422/485 expansion module (I-81xxW).

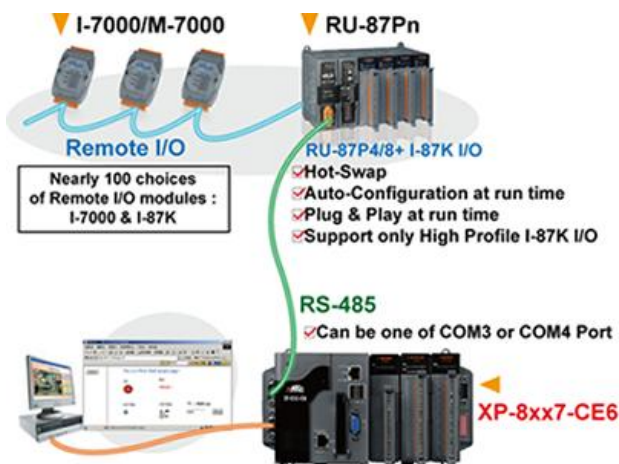

Multiple Web HMI - Monitor & Control Everywhere!

<input checked="" type="checkbox"/> XP-8xx7-CE6	<input checked="" type="checkbox"/> WP-8xx7	<input checked="" type="checkbox"/> VP-2xW7
---	---	---

- Monitor or control the local or remote controller via the Internet Explorer running on your PC.

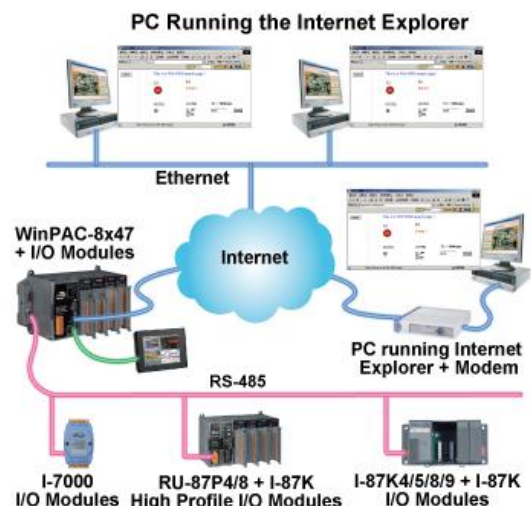

Motion Control

- XP-8xx7-CE6
- WP-8xx7
- VP-2xW7

- One I-8091W can control 2-axis: X-Y plane, or 2 independent axes.
- Two I-8091W can control 4-axis: X-Y plane + 2 independent axes or 4 independent axes.
- Encoder Modules: I-8093W : 3-axis ([FAQ-112](#))
I-8084W : 4-axis ([FAQ-100](#)), without Z-index
I-8090W : 3-axis



Data Exchange: Fbus or Ebus

- XP-8xx7-CE6
- WP-8xx7
- VP-2xW7

- **Fbus (RS-485 Network)**
- **Ebus (Ethernet Network)**
- The Ebus data exchange makes the configuration more flexible and faster.

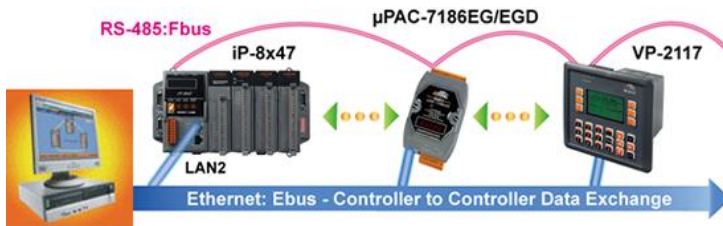

Data Recorder and Data Logger

- XP-8xx7-CE6
- WP-8xx7
- VP-2xW7

- Data, date & time can be stored (e.g., Battery Backup SRAM, Flash & microSD card, optional X-board, XW-board, etc.) and then PC can load these data via communication interface. (e.g., RS-232, RS-485, Ethernet, etc.)

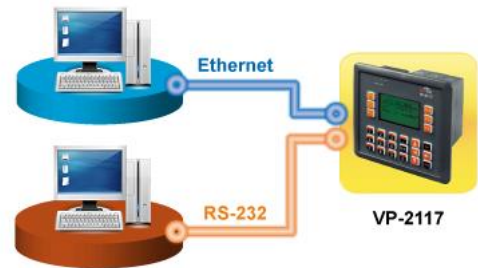

VIP Communication Security

- XP-8xx7-CE6
- WP-8xx7
- VP-2xW7

- In ISaGRAF Workbench, set VIP (Very Important IP No.) for Modbus TCP/IP security.

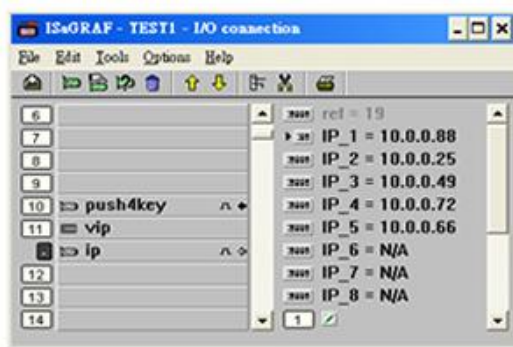

Detect Hot-Swap I-87K I/O Status

- XP-8xx7-CE6
- WP-8xx7
- VP-2xW7

- In ISaGRAF Workbench, connect the I/O board to the "I/O connection" windows and select the "io_state" board then observe the I/O status. When hot-swap the I-87K High Profile I/O, the message will show on the front panel of PAC.

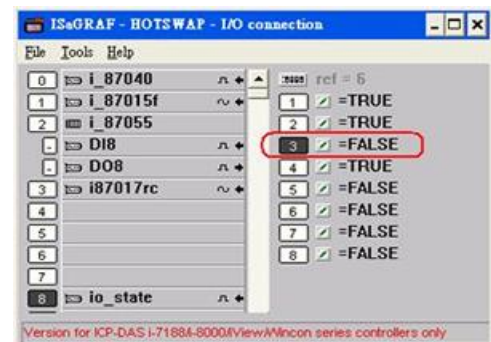

I/O Selection Guide

High Speed Local I/O Modules: **Parallel Bus**

I-8K High Profile Modules: More at www.icpdas.com > Products > PAC - 8K & 87K I/O Modules

I-8K Analog I/O Modules	
I-8014W	16-bit 250K sampling rate 8/16-ch. analog input module (The scan rate cannot reach 250K when using in the ISaGRAF PAC)
I-8017HW	8-ch. Differential or 16-ch. Single-ended, 14-bit, High Speed Analog Input Module. (current input require external 125 Ω resistor) (The scan rate cannot reach 100K when using in the ISaGRAF PAC)
I-8024W	4-ch. Isolated Analog Output Module (+/-10 V, 0 ~ +20 mA)
I-8K Digital I/O Modules	
I-8037W	16-ch. Isolated Open Collector Output Module
I-8040W	32-ch. Isolated Digital Input Module
I-8040PW	32-ch. Isolated Digital Input with Low Pass Filter Module
I-8041W	32-ch. Isolated Open Collector Digital Output Module (Sink)
I-8041AW	32-ch. Isolated Open Collector Digital Output Module (Source)
I-8042W	16-ch. Isolated Digital Input & 16-ch. Isolated Open Collector Digital Output Module
I-8046W	16-ch. Isolated Digital Input Module
I-8050W	16-ch. Universal Digital I/O Module
I-8051W	16-ch. Non-isolated Digital Input Module
I-8052W	8-ch. Differential Isolated Digital Input Module
I-8053W	16-ch. Isolated Digital Input Module
I-8053PW	16-ch. Isolated Digital Input with Low Pass Filter Module
I-8054W	8-ch. Isolated Digital Input Module & 8-ch. Isolated Open Collector Digital Output Module
I-8055W	Non-isolated 8-ch. Digital Logic Input Module & 8-ch. Open Collector Digital Output Module
I-8056W	16-ch. Non-isolated Open Collector Output Module
I-8057W	16-ch. Isolated Open Collector Output Module
I-8058W	8-ch. Differential Isolated Digital Input Module, Max. AC/DC Input : 250V
I-8060W	6-ch. Relay Output Module, AC: 0.6 A @ 125 V , 0.3 A @ 250 V; DC: 2 A @ 30 V
I-8063W	4-ch. Differential Isolated digital input & 4-ch. Relay output module, AC : 0.6 A @ 125 V ; 0.3 A @ 250 V
I-8064W	8-ch. Power Relay Output Module, AC: 5 A @ 250 V, DC: 5 A @ 30 V
I-8068W	4-ch. Form-A, 5 A @ 250 V _{AC} /28 V _{DC} & 4-ch. Form-C, 5 A (NO) /3 A (NC) @ 277 V _{AC} /30 V _{DC} Relay Output Module
I-8069W	8-ch. PhotoMOS Relay Output Module, Max. AC/DC: 1 A @ 60 V
I-8K Counter/Frequency Modules	
I-8084W	4-ch. Encoder, can be dir/pulse, or up/down or A/B phase (Quad. mode), Not support Encoder Z-index
I-8088W	8-ch. PWM Output and 8-ch. isolated DI Module, software support 1 Hz ~ 100 kHz (non-continuous).
I-8K Motion Modules	
I-8093W	3-axis Encoder Module, max. 1M Hz for quadrant input mode, max. 4M Hz for pulse/direction and cw/ccw input model
I-8090W	3-axis Encoder Module
I-8091W	2-axis Stepping/Servo Motor Control Card without encoder input
I-8092F	High Speed 2-axis Motion Control Module, with FRnet Master (For XP-8xx7-CE6 only)
I-8094	High Speed 4-axis Motion Control Module (For XP-8xx7-CE6 only)
I-8094F	High Speed 4-axis Motion Control Module, with FRnet Master (For XP-8xx7-CE6 only)
I-8K Communication Modules	
I-8135W	To expand the 2nd Ethernet port for the VP-25W7 / VP-23W7
I-8112iW	2-ch. Isolated RS-232 Expansion Module
I-8114W	4-ch. non-isolated RS-232 Expansion Module
I-8114iW	4-ch. Isolated RS-232 Expansion Module

I-8142iW	2-ch. Isolated RS-422/485 Expansion Module
I-8144iW	4-ch. Isolated RS-422/485 Expansion Module
I-8172W	2-port FRnet Module

RS-485 Remote I/O Modules: Serial Interface; HOT-SWAP
I-87K High Profile Modules: More at www.icpdas.com > Products > PAC - 8K & 87K I/O Modules

I-87K Analog I/O Modules	
I-87005W	8-ch. Thermistor input and 8-ch. digital output module
I-87013W	4-ch., 16-bit, 10 Hz (Total), 2/3/4 Wire RTD Input Module with Open Wire Detection
I-87015W	7-ch., 16-bit, 12 Hz (Total), RTD Input Module with Open Wire Detection (for short sensor distance)
I-87015PW	7-ch. RTD Input Module with 3-wire RTD lead resistance elimination and with Open Wire Detection (for long sensor distance)
I-87017RW	8-ch. Differential , 16/12-bit, 10/60 Hz (Total) Analog Input Module with 240 V _{rms} Over Voltage Protection, Range of -20 ~ +20 mA Requires Optional External 125 Ω Resistor
I-87017RCW	8-ch. Differential , 16/12-bit, 10/60 Hz(Total) Current Input Module
I-87017W	8-ch. Analog Input Module
I-87017W-A5	8-ch. High Voltage Input Module
I-87018RW	8-ch. Thermocouple Input Module. Recommend to use the better I-87018Z.
I-87018W	8-ch. Thermocouple Input Module. Recommend to use the better I-87018Z.
I-87018ZW	10-ch. Differential , 16-bit, 10 Hz (Total), Thermocouple Input Module with 240 V _{rms} Over Voltage Protection, Open Wire Detection, Range of +/-20 mA, 0~20 mA, 4~20 mA requires Optional External 125 Ω Resistor
I-87019RW	8-ch. Diff. , 16-bit, 8 Hz (Total), Universal Analog Input Module with 240 V _{rms} Over Voltage Protection, Open Wire Detection (V, mA, Thermocouple; Range of -20 ~ +20 mA need to set Jumper on board)
I-87024CW	4-ch. 12-bit channel to channel isolated current output module with open-wire detection
I-87024W	4-ch. 14-bit analog output module (0 ~ +5 V, +/-5 V, 0 ~ +10 V, +/-10 V, 0 ~ +20 mA, +4 ~ +20 mA)
I-87028CW	8-ch. 12-bit current output module
I-87H17W	8-ch. analog input module and HART master module.
I-87K Digital I/O Modules	
I-87040W	32-ch. Isolated Digital Input Module
I-87041W	32-ch. Sink Type Open Collector Isolated Digital Output Module
I-87046W	16-ch. Non-Isolated Digital Input Module for Long Distance Measurement
I-87051W	16-ch. Non-Isolated Digital Input Module
I-87052W	8-ch. Differential , Isolated Digital Input Module
I-87053PW	16-ch. Isolated Digital Input Module with 16-bit Counters
I-87053W	16-ch. Isolated Digital Input Module
I-87053W-A5	16-ch. 68 ~ 150 V _{DC} Isolated Digital Input Module
I-87054W	Isolated 8-ch. DI and 8-ch. Open Collector DO Module
I-87055W	Non-Isolated 8-ch. DI and 8-ch. Open Collector DO Module
I-87057W	16-ch. Open Collector Isolated Digital Output Module
I-87058W	8-ch. 80~250 V _{AC} Isolated Digital Input Module
I-87059W	8-ch. Differential 10-80 V _{AC} Isolated Digital Input Module
I-87061W	16-ch. Relay Output Module (RoHS)
I-87063W	4-ch. Differential Isolated Digital Input and 4-ch. Relay Output Module 5 A (NO) / 3 A(NC) @ 5 ~ 24 V _{DC} ; 5 A(NO) / 3 A(NC) @ 0 ~ 250 V _{AC}
I-87064W	8-ch. Relay Output Module, 5 A (47~63 Hz) @ 0~ 250 V _{AC} ; 5 A @ 0~ 30 V _{DC}
I-87065W	8-ch. AC SSR Output Module, AC: 1.0 A _{rms} @ 24 ~ 265 V _{rms}
I-87066W	8-ch. DC SSR Output Module , DC: 1.0 A _{rms} @ 3 ~ 30 V _{DC}
I-87068W	4-ch. Form-A Relay Output and 4-ch. Form-C Relay Output Module ; Form-A: 8 A @ 250 V _{AC} ; 8 A @ 28 V _{DC} . Form-C: 5 A (NO) / 3 A (NC) @ 277 V _{AC} ; 5 A(NO) / 3 A(NC) @ 30 V _{AC}
I-87069W	8-ch. PhotoMOS Relay Output Module, Max. AC/DC: 0.13 A @ 350 V
I-87K Counter/Frequency Modules	
I-87082W	2-ch. Counter/Frequency Module, Isolated or Non-isolated Inputs
I-87K PWMS Modules	
I-87088W	8-ch. PWM outputs, software support 1 Hz~100 kHz, (non-continuous), duty: 0.1 ~ 99.9%



I-87K GPS Modules	
I-87211W	Time-Synchronization and GPS module for getting UTC/local time and local Longitude/Latitude

RS-485 Remote I/O Modules	
I-7000	 Products > Remote I/O Modules/Units > I-7000 Modules > Selection Guide">www.icpdas.com > Products > Remote I/O Modules/Units > I-7000 Modules > Selection Guide
M-7000	 Products > Remote I/O Modules/Units > M-7000 Modules > Selection Guide">www.icpdas.com > Products > Remote I/O Modules/Units > M-7000 Modules > Selection Guide
RS-485 Remote Hot-Swap Expansion Unit	
RU-87P1/2/4/8	 Products > Remote I/O Modules/Units > Remote I/O Expansion Unit > Selection Guide">www.icpdas.com > Products > Remote I/O Modules/Units > Remote I/O Expansion Unit > Selection Guide
RS-485 Remote Expansion Unit	
I-87K1/4/5/8/9	 Products > Remote I/O Modules/Units > Remote I/O Expansion Unit > Selection Guide">www.icpdas.com > Products > Remote I/O Modules/Units > Remote I/O Expansion Unit > Selection Guide