

Classification	Win-GRAF English FAQ-019						
Author	Janice Hong	Version	1.0.0	Date	2017, 09	Page	1 / 40

How to Create an eLogger HMI and a Schedule-Control Application for a Win-GRAF PAC?

All Win-GRAF WinCE series PAC support the Schedule-Control function. A single PAC supports a maximum of 10 targets for schedule control. Each target can control three variables – one Boolean, one 32-bit Integer and one Real variable.

- Support a maximum of 10 control Targets.
- Support the scheduling for Normal Days, Holidays, and Special Days.
- Support 15 time periods for each Schedule.
- Support using the local languages.
- Support working with an eLogger HMI.
- Support working with the Win-GRAF softlogic.



Chapter 1. Download and Install the Software

ICP DAS provides a free Schedule-Control utility that allows the user to quickly and easily complete the schedule settings on a PC or a PAC. This FAQ-019 also provides demo programs for the Schedule-Control utility, Win-GRAF and eLogger HMI. Visit the Win-GRAF FAQ web page to get the demo_faq019.zip file which includes this document and all demo programs:

www.icpdas.com > Support > FAQ > Win-GRAF Soft-Logic PAC > FAQ-019 or
<http://www.icpdas.com/root/support/faq/win-graf.php>



Schedule-Control Utility

There is a Schedule-Control utility called **Schedule_in_PC.exe** in the CD:\napdos\Win-GRAF\Tools_Utility\ in the packing box of the Win-GRAF PAC. First, copy this file and the label_name.txt to your PC, and recommended to put it in the same folder with the schedule file, e.g., D:\Schedule-Control\Station1\.

Also, there is a Schedule-Control utility called **Schedule_in_PAC.exe** in the \System_Disk\Win-GRAF\ in the Win-GRAF PAC.

Classification	Win-GRAF English FAQ-019						
Author	Janice Hong	Version	1.0.0	Date	2017, 09	Page	2 / 40

Win-GRAF

Visit the Win-GRAF web page for more information about the software, drivers, and manuals.

www.icpdas.com > Products > Solutions > Soft PLC, Win-GRAF, ISaGRAF & eLogger HMI > Win-GRAF or
http://www.icpdas.com/root/product/solutions/softplc_based_on_pac/win-graf/win-graf.html

If you are not familiar with the Win-GRAF software, read the following chapters in the Win-GRAF User Manual:

- See Chapter 1 to install the Win-GRAF Workbench
- See Chapter 2 to create, edit, and compile the project, and then download it to the Win-GRAF PAC.
- See Chapter 17 for more information about the schedule control.



eLogger HMI

Visit the eLogger HMI web page for more information about the software and manuals.

www.icpdas.com > Products > Solutions > Software > SCADA/HMI > eLogger or
http://www.icpdas.com/root/product/solutions/software/scada_hmi/eLogger/eLogger.html



Refer the Win-GRAF FAQ-018:

How to Use Win-GRAF SoftLogic and eLogger HMI in the Win-GRAF PAC?

See Chapter 2 to know how to install and use the eLogger HMI.

<http://ftp.icpdas.com/pub/cd/win-graf-pac-cd/napdos/faq/chinese/faq-018-tc.pdf>

Introduction of Demo Programs

After you unzip the demo_faq019.zip file, the following demo files included in the folder:

1. schedule01.txt
It is the configuration file of the Schedule-Control utility, and we called Schedule file.
2. W_schedule.zip
It is a Win-GRAF project which used to conduct the scheduling control and release the variables for an eLogger HMI or other PAC to read data.
3. eL-Schedule.wez (ViewPAC: 640 * 480)
It is an eLogger project which used to design the eLogger HMI page and used to read data (i.e., the scheduling data and PAC time) from the Win-GRAF PAC.

Classification	Win-GRAF English FAQ-019						
Author	Janice Hong	Version	1.0.0	Date	2017, 09	Page	3 / 40

Chapter 2. Introduction of the Schedule Control Utility

2.1. Configure the Target

Note: If you are familiar with this software, go to [Chapter 3](#) for demo programs.

Execute the Schedule-Control utility, and click the "New" button to create a new scheduling. As you can see in the figure, there are 10 buttons named Target 1 to Target 10 by default. Each Target can set as different seasons for scheduling, and any configured Target marked with "*" on the button.

Apart from creating a new scheduling, the user can modify an existing scheduling file from a PC or a PAC.

- New: Create a file.
- Open from PC: Open an existing scheduling file from the PC.
- Get from Controller: Load an existing scheduling file from the PAC after entering its IP address and password.

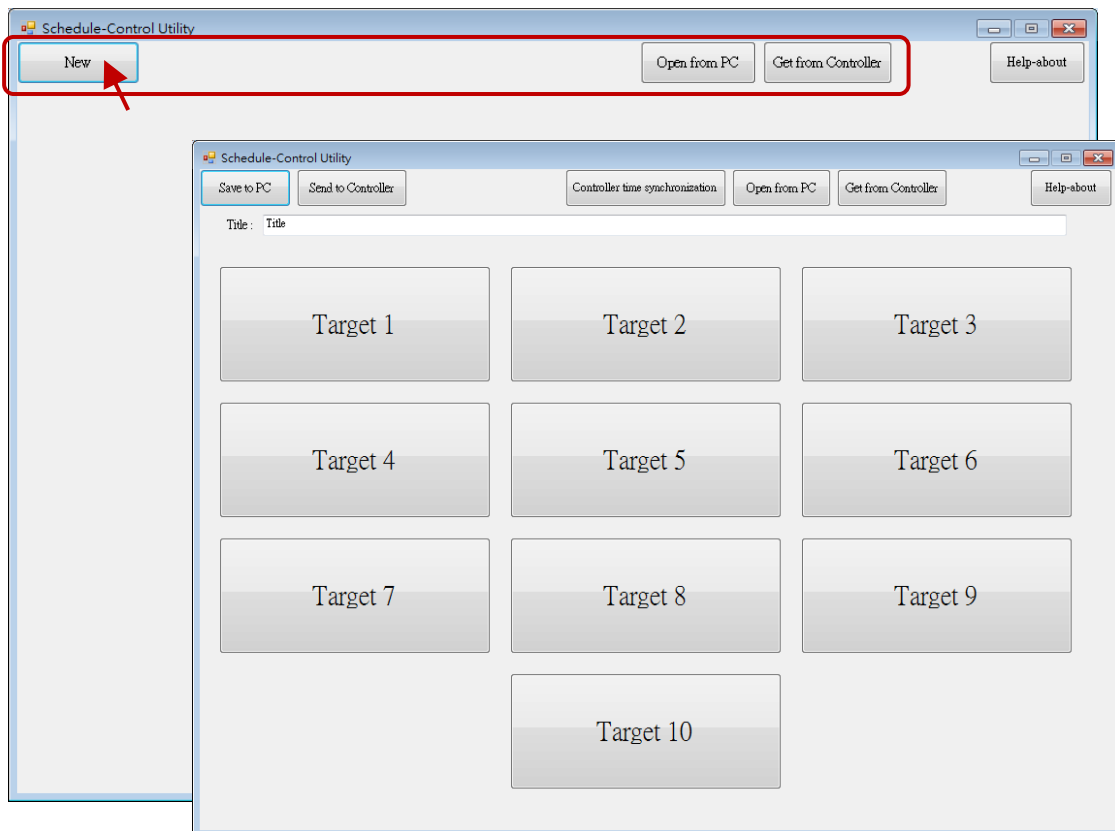

Change the label name to meet different application needs:

The user can modify the name of the Target, Season, and so on, according to the needs of the application field. Open the Label_Name.txt in the folder that the Schedule_in_PC.exe is located (e.g., D:\Schedule-Control\Station1\)) and follow instructions as below.

Classification	Win-GRAF English FAQ-019							
Author	Janice Hong	Version	1.0.0	Date	2017, 09	Page	4 / 40	

Notes for creating the file “Label_Name.txt”:

1. If this file does not exist, the target shows the default name (e.g., Target 1, Target 2).
2. In this file, change the target name (e.g., “ **Factory** ”, the prefix/suffix of spaces will be erased.) or the name of other items (e.g., Season, Normal day, Holiday, Schedule, etc.) after the colon (“ : ”).
3. The user can create and edit it by using MS Notepad or other editors, but must select the “Unicode” format when saving it.
4. On the PAC, copy this file into the same folder with the Schedule_in_PAC.exe, i.e., \System_Disk\
Win-GRAF\.

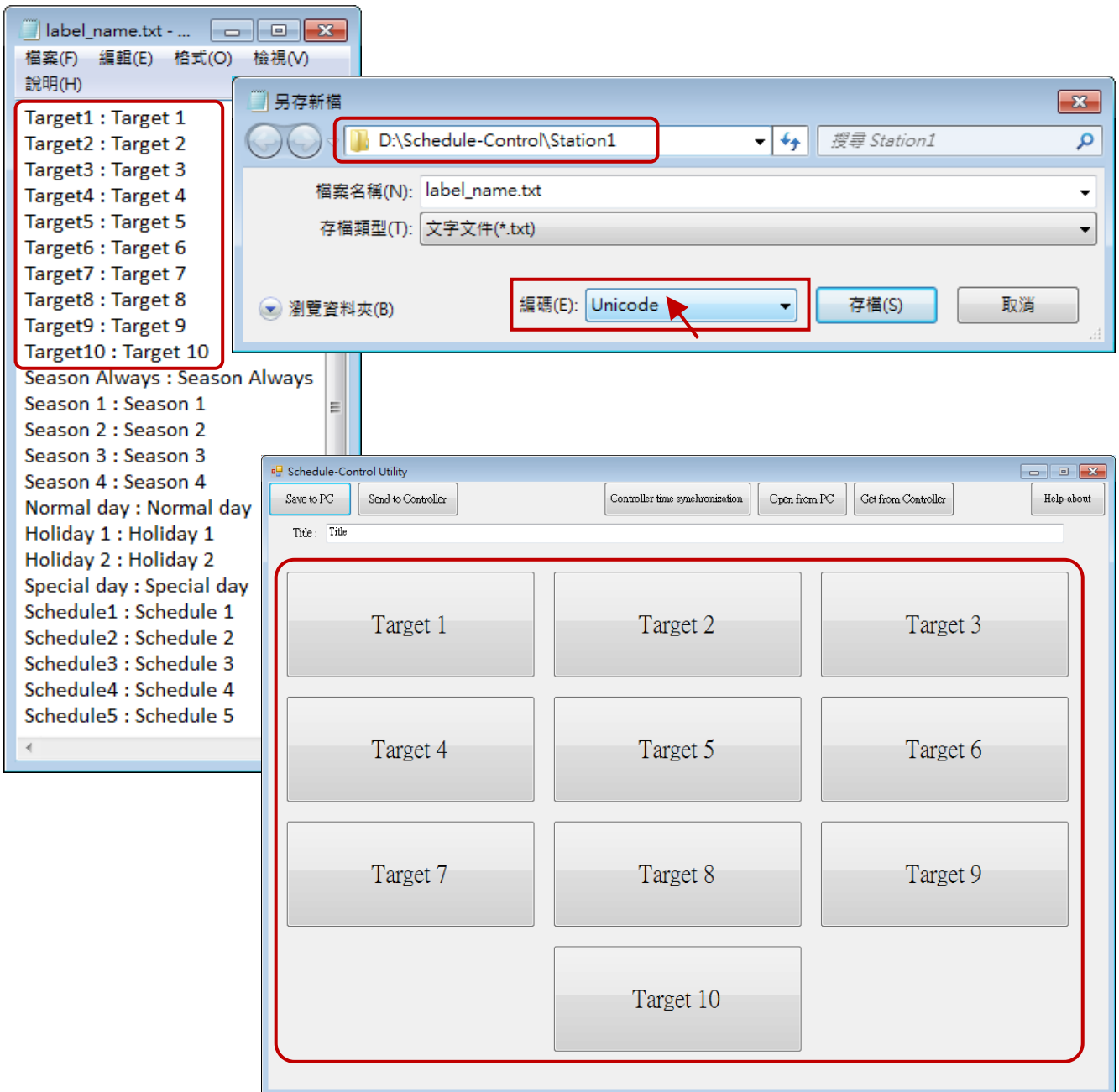

Classification	Win-GRAF English FAQ-019							
Author	Janice Hong	Version	1.0.0	Date	2017, 09	Page	5 / 40	

2.2. Configure the Season

Each “Target” (1 to 10) includes the “Season Always”, “Season 1”, “Season 2”, “Season 3” and “Season 4” setting items. It is recommend to check "Season Always" that means to enable the year-round schedule.

The screenshot shows the 'Schedule-Control Utility' window for 'Target 1 > Season Always > Normal day'. At the top, there are 'Back' and 'Save to PC' buttons. Below them, 'Target 1' is checked. A 'Default Value' section includes a 'Boolean' dropdown set to 'OFF', an 'Integer' input field with '0', and a 'Real' input field with '0.0'. The main area features a 'Season Always' checkbox (checked) with a red arrow pointing to it, and five buttons labeled 'Season 1' through 'Season 4'. A red box highlights the 'Season Always *' button, with a blue line connecting it to a larger blue box below. This box contains 'Normal day' (checked) and radio buttons for 'Normal day (Schedule 1 *)', 'Holiday 1', 'Holiday 2', and 'Special day'. To the right of these are 'Apply' and 'Schedule 1 *' dropdown menus, and a list of checkboxes for days of the week: Sunday (unchecked), Monday (checked), Tuesday (checked), Wednesday (checked), Thursday (checked), Friday (checked), and Saturday (unchecked). On the far right, there are five buttons labeled 'Schedule 1 *' through 'Schedule 5'.

Note: See Chapter 17 Schedule Control of the Win-GRAF user manual for more details about the settings.

Classification	Win-GRAF English FAQ-019							
Author	Janice Hong	Version	1.0.0	Date	2017, 09	Page	6 / 40	

2.2.1. Configure the Normal Day, Holiday, or Special Day

The Season setting can be set to the Normal day, Holiday 1, Holiday 2 or Special day. When enabling the setting, users must choose a Schedule number (1 to 5) to apply the time settings.

Normal day	The normal days are Monday to Friday.
Holiday 1	Normally set to Saturday and Sunday.
Holiday 2	In some workplace, there are different holidays, e.g., Wednesday.
Special Day	Set the schedule for local holidays or the adjusted working-day. E.g., Oct. 10, Jul. 4, Oct. 1, Dec. 25, etc. A maximum of 50 days can be set per Season.

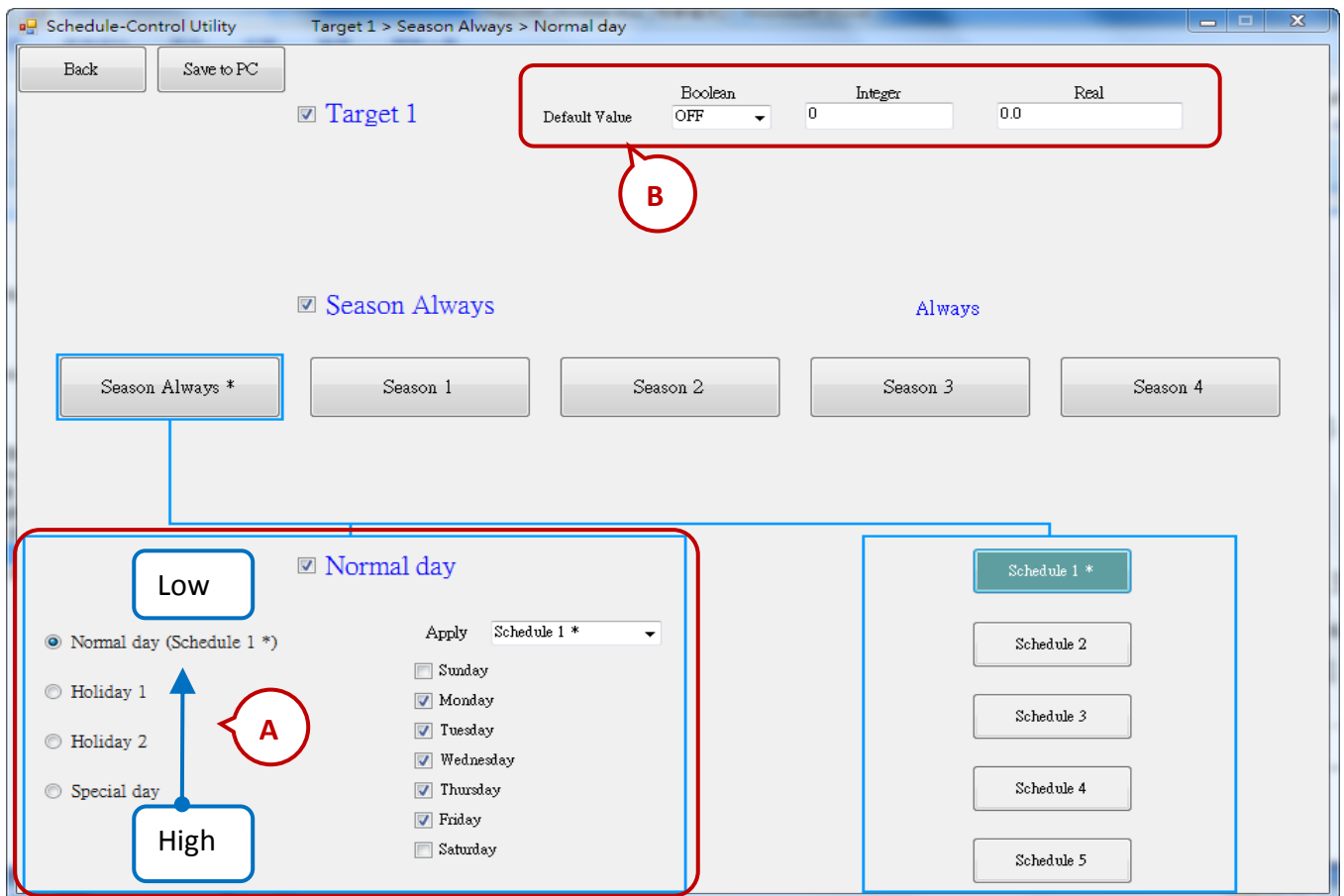

A. The Searching Priority of the Normal day, Holiday, and Special Day:

Special Day (High) → Holiday 2 → Holiday 1 → Normal day (Low).

Classification	Win-GRAF English FAQ-019							
Author	Janice Hong	Version	1.0.0	Date	2017, 09	Page	7 / 40	

1) The date of the Normal day, Holiday 1, and Holiday 2 can not overlap. For example,

	The Correct Settings	The Wrong Settings
Normal day	Monday, Tuesday, Wednesday, Thursday, Friday	Monday, Tuesday, Wednesday, Thursday, Friday
Holiday 1	Sunday, Saturday	Saturday
Holiday 2	Disabled	Sunday, Friday

2) Configure a date for the Special Day:

A maximum of **50** special days, i.e., local holidays or the adjusted working-day, can be set per Season. Each enabled date of the Special Day must be assigned a Schedule number (1 to 5).

B. The Default Value of the Boolean, Integer, and Real Variable :

In Season Always, if the Dates and Time Periods are not in the setting conditions, the variables will be assigned the "Default Values" (Boolean = OFF, Integer = 0, and Real = 0). The user can also set the Default Values by desired.

Classification	Win-GRAF English FAQ-019						
Author	Janice Hong	Version	1.0.0	Date	2017, 09	Page	8 / 40

2.2.2. Configure the Schedule

A maximum of 5 Schedules (1 to 5) can set per Season, and a maximum of 15 time periods can set per Schedule. The time unit is minutes and must be in the range of 00:00 to 24:00.

The searching priority of Time Periods in the schedule is in the order of the largest number to the smallest number. If the Time Periods overlap, the PAC conducts the schedule control with the larger number settings. If none of these 15 Time Periods is matching, using the default values.

	Hour	Minute	To	Hour	Minute	Boolean	Integer	Real
<input checked="" type="checkbox"/> 01:	8	30		12	0	ON	10	12.34
<input checked="" type="checkbox"/> 02:	13	0		17	30	ON	20	25.67
<input type="checkbox"/> 03:	0	0		0	0	OFF	0	0
<input type="checkbox"/> 04:	0	0		0	0	OFF	0	0
<input type="checkbox"/> 05:	0	0		0	0	OFF	0	0
<input type="checkbox"/> 06:	0	0		0	0	OFF	0	0
<input type="checkbox"/> 07:	0	0		0	0	OFF	0	0
<input type="checkbox"/> 08:	0	0		0	0	OFF	0	0
<input type="checkbox"/> 09:	0	0		0	0	OFF	0	0
<input type="checkbox"/> 10:	0	0		0	0	OFF	0	0
<input type="checkbox"/> 11:	0	0		0	0	OFF	0	0
<input type="checkbox"/> 12:	0	0		0	0	OFF	0	0
<input type="checkbox"/> 13:	0	0		0	0	OFF	0	0
<input type="checkbox"/> 14:	0	0		0	0	OFF	0	0
<input type="checkbox"/> 15:	0	0		0	0	OFF	0	0

Classification	Win-GRAF English FAQ-019							
Author	Janice Hong	Version	1.0.0	Date	2017, 09	Page	9 / 40	

2.3. Save & Send the Schedule file to the Win-GRAF PAC

After completing the settings, save and send the schedule file to the PAC:



1. Click the “Save to PC” button to save the configuration file (“*.txt”).

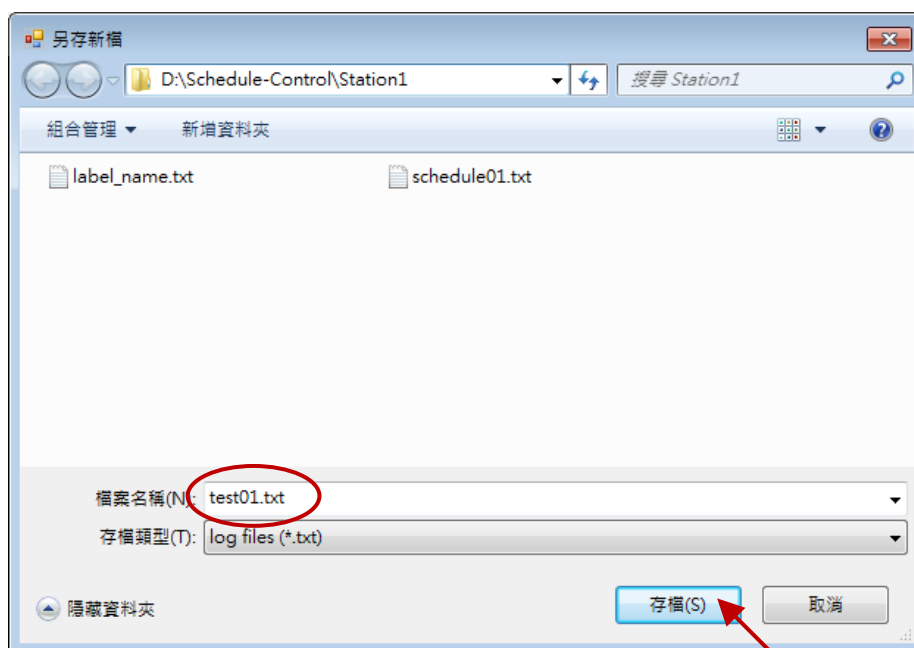

2. Click the “Send to Controller” button to send the Schedule file to the PAC. Simply, enter the IP address of the PAC and the password (defaults: 0). Note that you can tick the "Remember password" option to transfer the file faster next time.

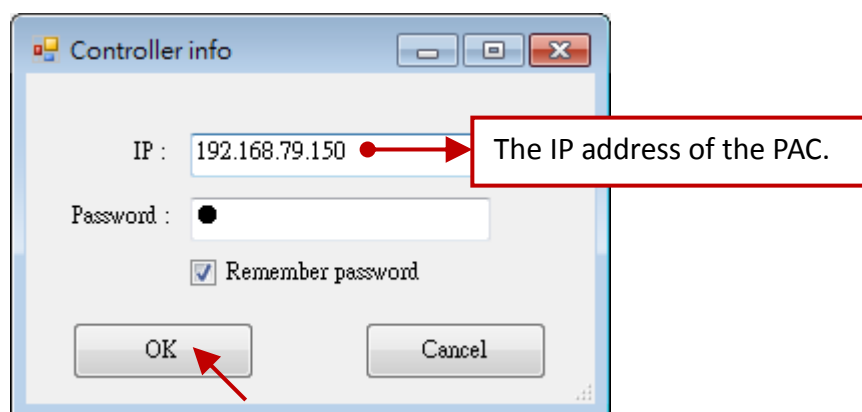

Classification	Win-GRAF English FAQ-019							
Author	Janice Hong	Version	1.0.0	Date	2017, 09	Page	10 / 40	

2.3.1. Time Synchronization

If you never calibrate the PAC time during a long-term working (e.g., one year), there may be a time error for 10 seconds to several minutes. For conducting the schedule in the same time, the Schedule-Control utility provides a function to synchronize the PAC time with your PC.

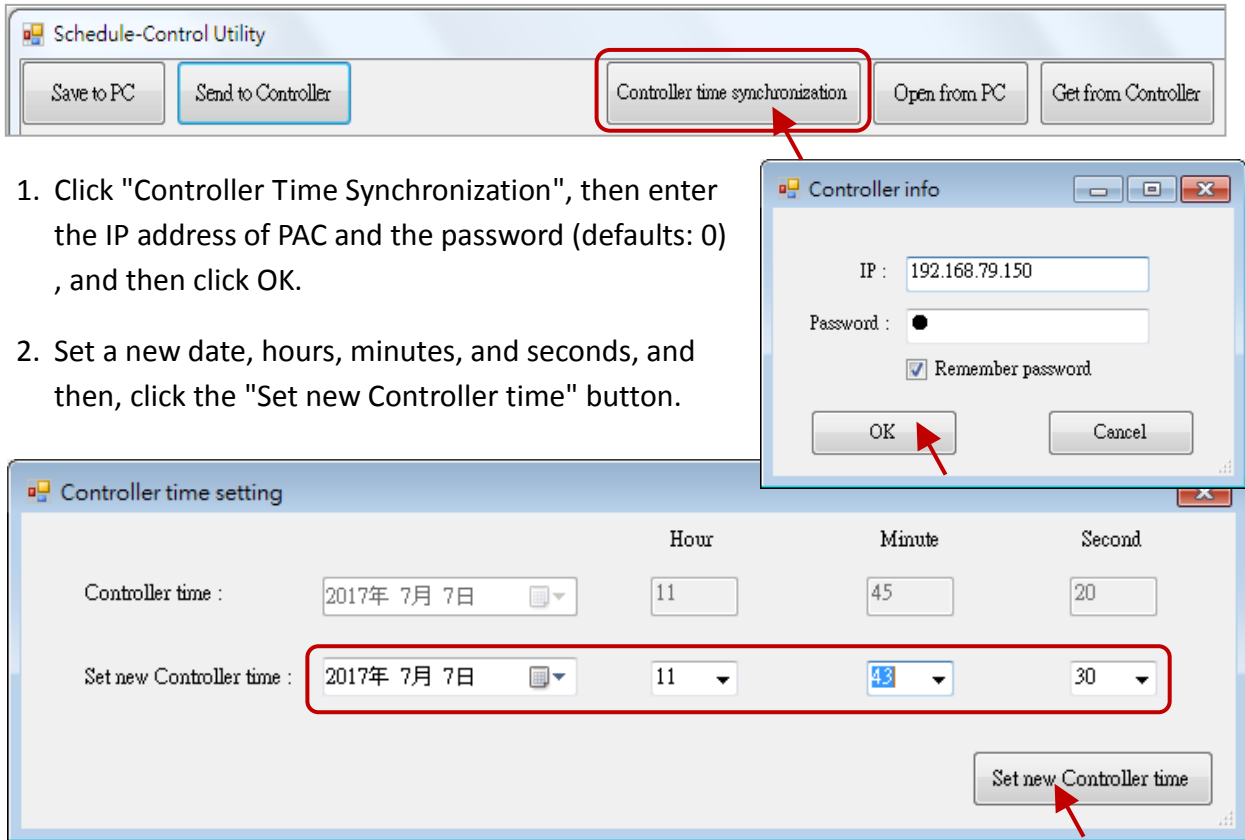

1. Click "Controller Time Synchronization", then enter the IP address of PAC and the password (defaults: 0) , and then click OK.
2. Set a new date, hours, minutes, and seconds, and then, click the "Set new Controller time" button.

2.3.2. Configure the Schedule-Control Utility on the PAC

The configure ways on PAC or PC are the same, only the screen looks a bit different. See Section [2.1](#) to [2.2](#).

1. The "Target" Setting:
See [Section 2.1](#).

Note:

Remember to add the path of the software to the Auto Execution of the PAC Utility. (i.e., \System_Disk\Win-GRAF\schedule_in_pac.exe)

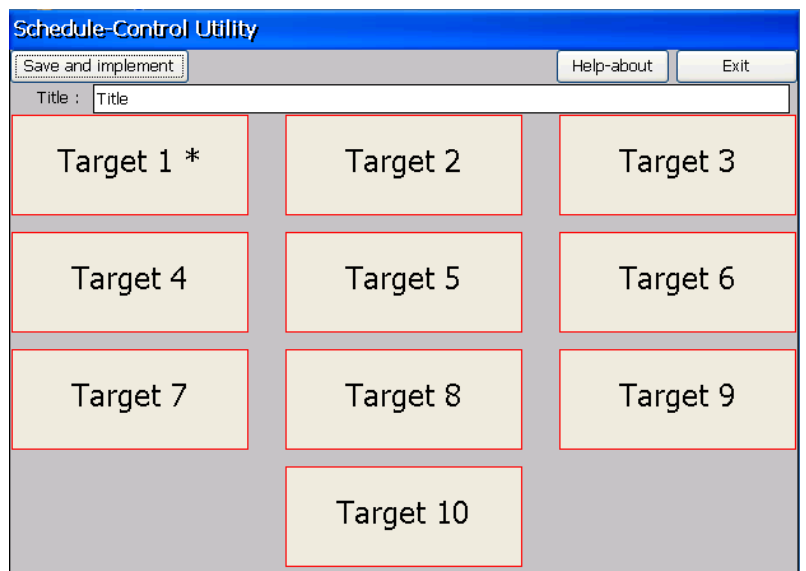

Classification	Win-GRAF English FAQ-019						
Author	Janice Hong	Version	1.0.0	Date	2017, 09	Page	11 / 40

2. The "Season" Setting:
See [Section 2.2.](#)

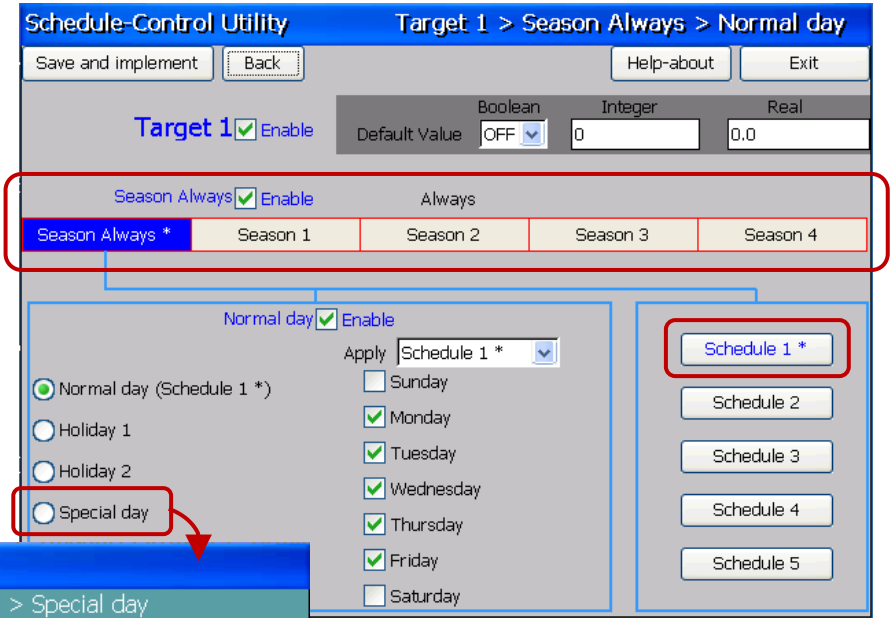

3. The "Special day" Setting:
See [Section 2.2.1.](#)

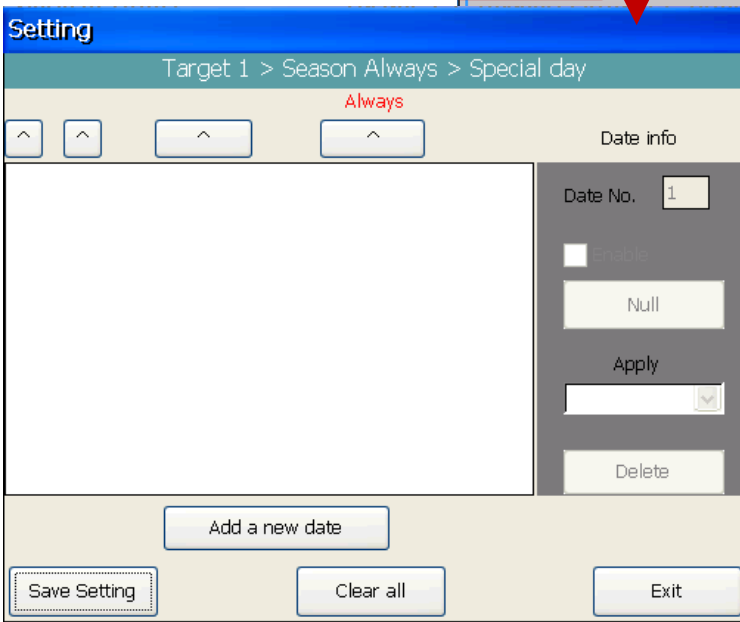

4. The "Schedule" Setting:
See [Section 2.2.2.](#)

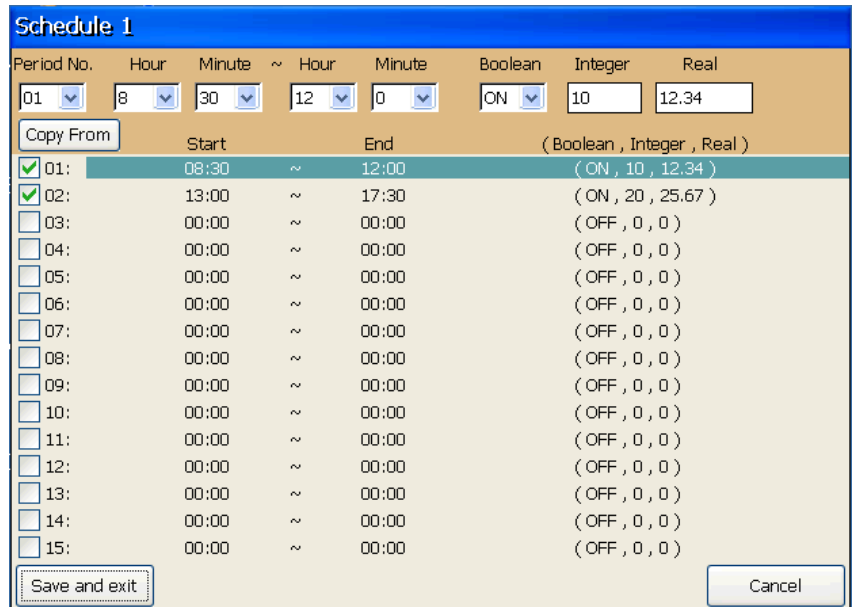

Classification	Win-GRAF English FAQ-019						
Author	Janice Hong	Version	1.0.0	Date	2017, 09	Page	12 / 40

Chapter 3. Introduction of Demo Programs

In this example, we use the following hardware products to conduct the schedule control.

Device	Model	Description
Win-GRAF PAC	VP-1238-CE7	Used to deal with 8 targets for the shedule control.
I-87K High Profile I/O Modules	I-87057W	16-ch DO module which be installed on the slot0 of the PAC, and used to control the status of mechines, a sprinkler, lights, and air-conditioners.
	I-87018RW	8-ch thermocouple AI module which be installed on the slot1 of the PAC, and used to display the current indoor temprature.

On the HMI pages:

Page – Schedule

Note: This page only allows you to view the statuses or values of the devices.

1. It can display the ON/OFF status of the machines (M1 - M3), the sprinkler (W1), the lamps (L1, L2), and the air-conditioners (C1, C2). Also, the scheduled and the current temperatures (T1, T2).
2. The red LEDs lit indicates that it is currently in the "ON" period of the schedule. If not, displays by the default values.
3. Click the Auto/Manual Mode can display the configuration page.

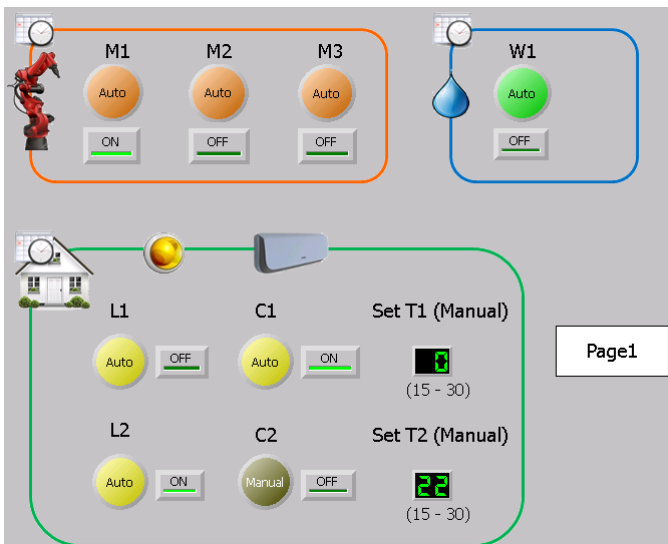
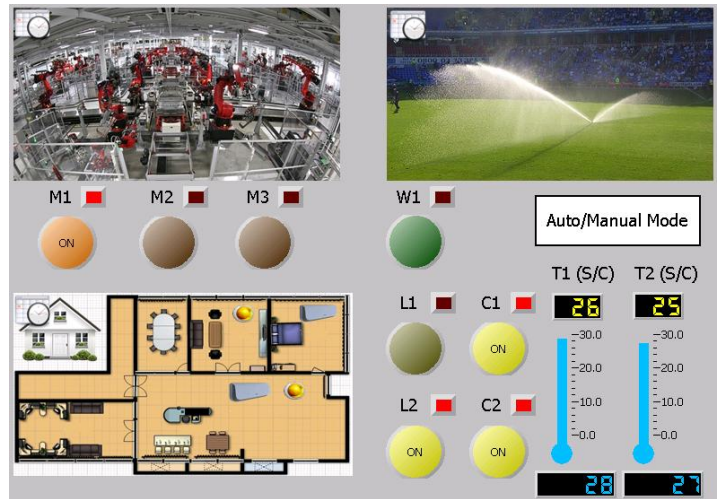

Page - Auto/Manual Mode

1. The default mode is Auto. If set it to the Manual mode, you can change the device statuses and the scheduled temperatures.
2. When the Auto is set, the scheduled status and temperature will be displayed on the Schedule page.
3. In Auto mode, the C1/C2=OFF and T1/T2=0 during "OFF" period. But, if the indoor temperature is larger than 30 °C, the air-conditioners (C1/C2) will set to ON, and the scheduled temperatures (T1/T2) will set to 28.

Classification	Win-GRAF English FAQ-019							
Author	Janice Hong	Version	1.0.0	Date	2017, 09	Page	13 / 40	

The following will introduce you the demo programs of the Schedule-Control Utility, Win-GRAF, and eLogger HMI.

3.1. The Configuration File of the Schedule-Control Utility

Visit the [Win-GRAF FAQ web page](#) (FAQ-019) to download the Schedule file (schedule01.txt), and copy this file to the location where the "Schedule_in_PC.exe" is stored in (e.g., D:\Schedule-Control\Station1\).

1. Execute the Schedule-Control utility, and click "Open from PC" to open an existing file (schedule01.txt)
Alternatively, click "New" to create a new settings.

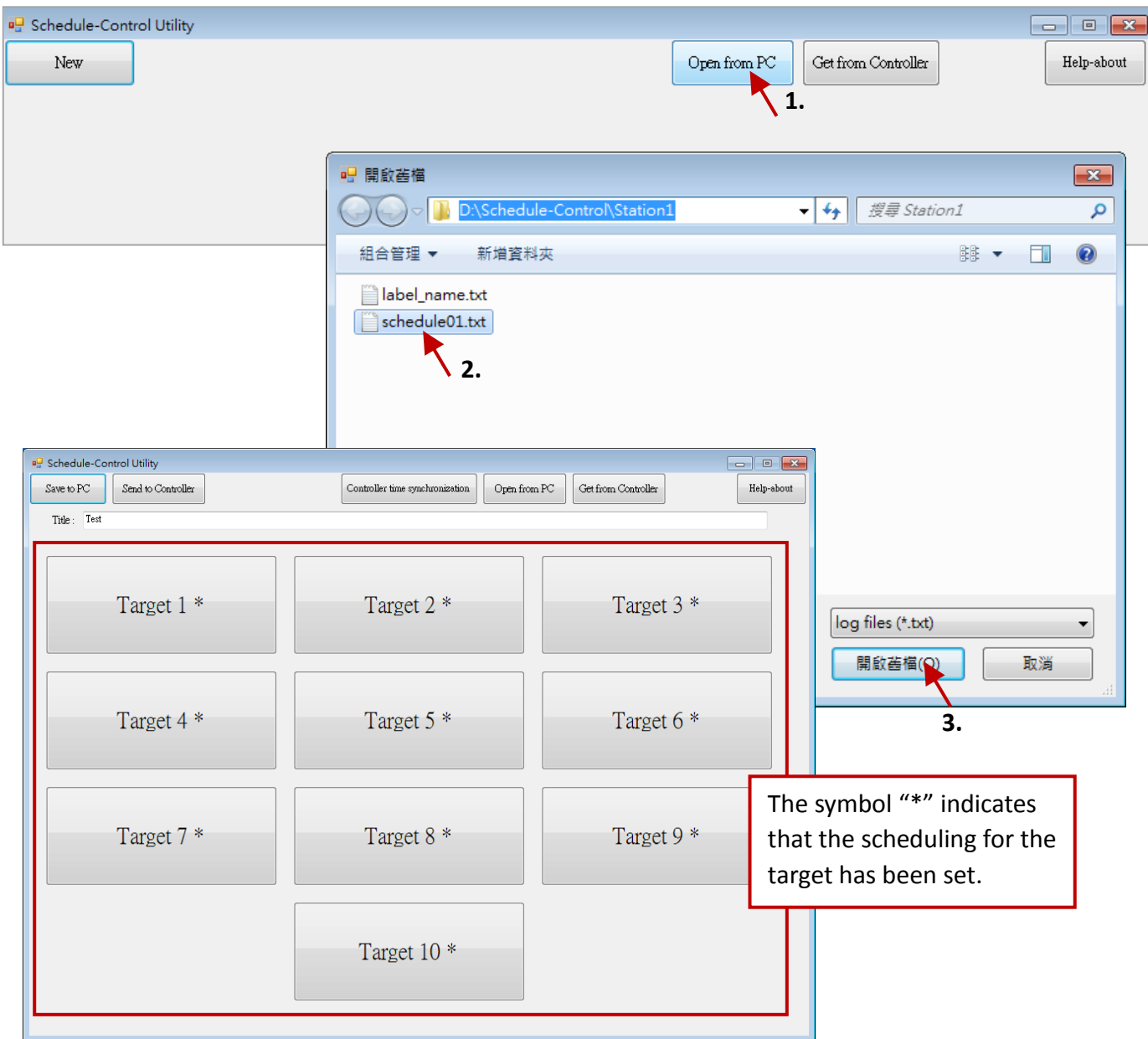

The symbol "*" indicates that the scheduling for the target has been set.

Classification	Win-GRAF English FAQ-019						
Author	Janice Hong	Version	1.0.0	Date	2017, 09	Page	14 / 40

2. In this case, we enabled 8 targets and each of them are set as "Season Always". See the following settings first.

Season Always	Normal day	Schedule 1						
		Hour/Minute	Boolean	Integer	Real			
Factory (M1)	Mon. to Fri.	01	8:30 – 12:00	ON	0	0		
Factory (M2)			12:00 – 15:00					
Factory (M3)			15:00 – 18:00					
Lawn (W1)	Mon., Wed., and Fri.	01	9:00 – 9:03					
Home (L1)	Mon. to Fri.	01	6:00 – 8:00					
		02	17:00 – 22:00					
Home (C1, T1)	Mon. to Fri.	01	8:00 – 18:00				26	26
Home (L2)	Sun. to Sat.	01	08:00 – 12:00				0	0
		02	17:30 – 23:00					
Home (C2, T2)	Sun. to Sat.	01	09:00 – 18:00	25	25			

3. Configuring the targets by using the settings above, and then click "Save to PC" to save the file called schedule01.txt. Click "Back" to go to the main screen. Note that we do not change the default values in this example, i.e., Boolean: OFF, Integer: 0 and Real: 0.0.

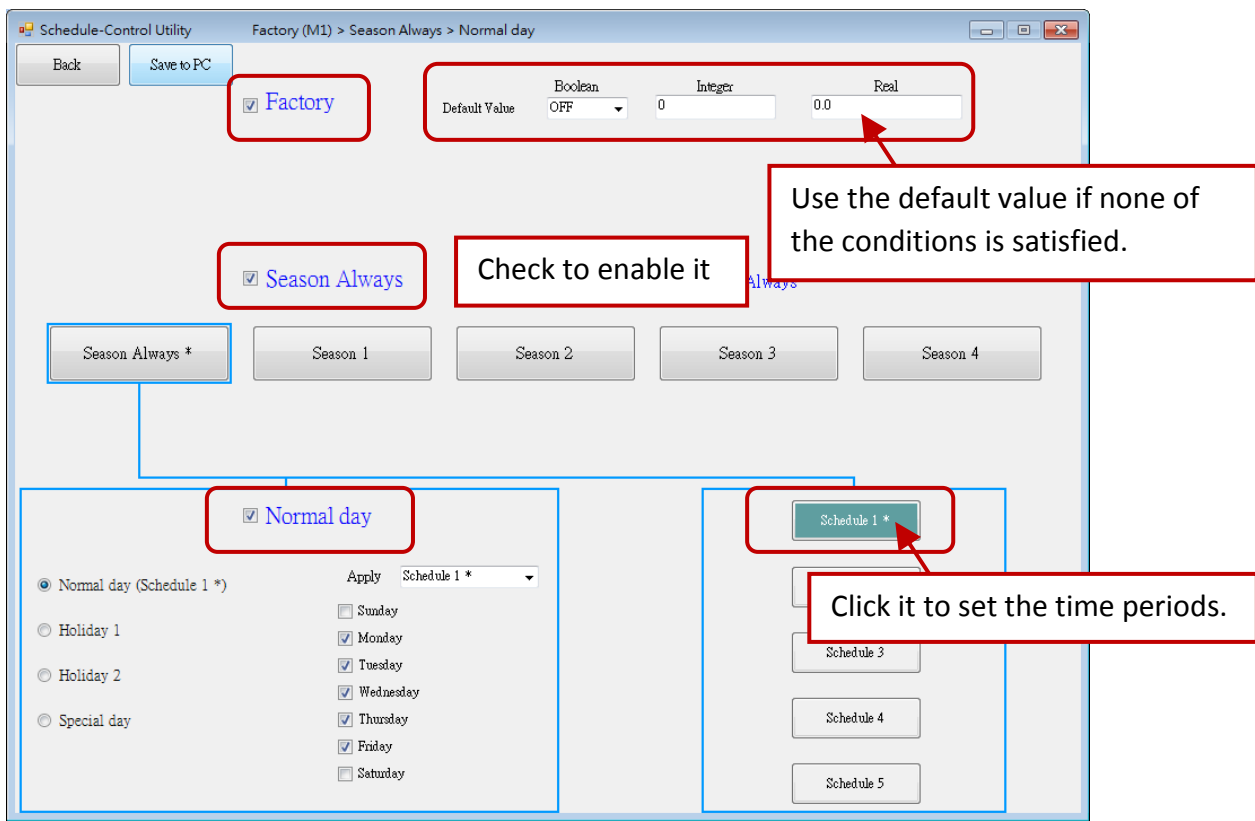

Classification	Win-GRAF English FAQ-019							
Author	Janice Hong	Version	1.0.0	Date	2017, 09	Page	15 / 40	

Note: Up to 15 time periods can be set per Schedule. In the target - Home (C2, T2), we set the Boolean variable to ON, the Integer value as "25", and the Real value as "25" when the time is between 9:00 AM and 18:00 PM. Otherwise, using default values (i.e., Boolean: OFF, Integer: 0 and Real: 0.0, see the table above.)

	Hour	Minute	To	Hour	Minute	Boolean	Integer	Real
<input checked="" type="checkbox"/> 01:	9	0		18	0	ON	25	25
<input type="checkbox"/> 02:	0	0		0	0	OFF	0	0
<input type="checkbox"/> 03:	0	0		0	0	OFF	0	0

- After completing the settings, click "Send to Controller" to send the Schedule file to the PAC. Then, enter the IP address of the PAC and the password (defaults: 0, see [Section 3.2.2 - Configure the I/O Boards - Password](#)), and then click OK.

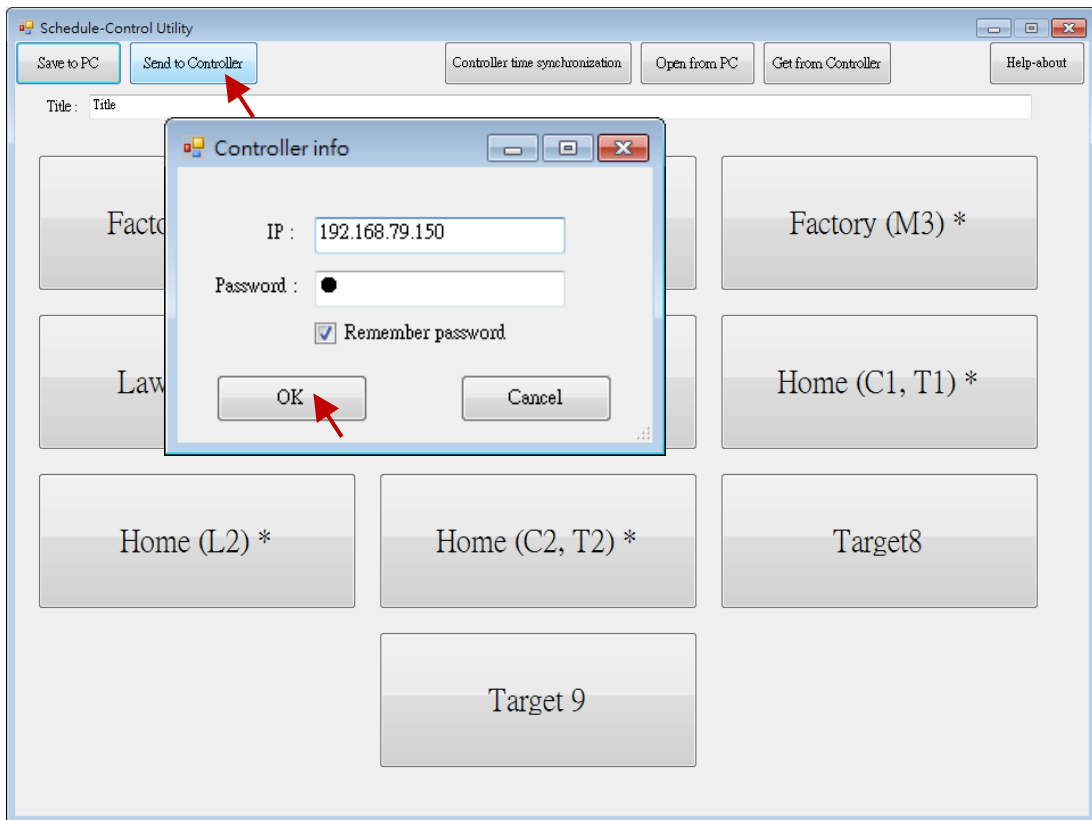

Classification	Win-GRAF English FAQ-019							
Author	Janice Hong	Version	1.0.0	Date	2017, 09	Page	16 / 40	

3.2. The Win-GRAF Demo Programs

First, prepare a single Win-GRAF PAC (e.g., VP-1238-CE7). A single Win-GRAF PAC supports a maximum of 10 targets for the schedule control. Each target can control one Boolean, one 32-bit Integer and one Real variable (i.e., BOOL/DINT/REAL).

3.2.1. Restore the Win-GRAF Project (W_schedule.zip)

Visit the www.icpdas.com > Support > FAQ > Win-GRAF Soft-Logic PAC > [FAQ-019](#) to download the project file (W_schedule.zip), and then restore it to the PC / Win-GRAF.

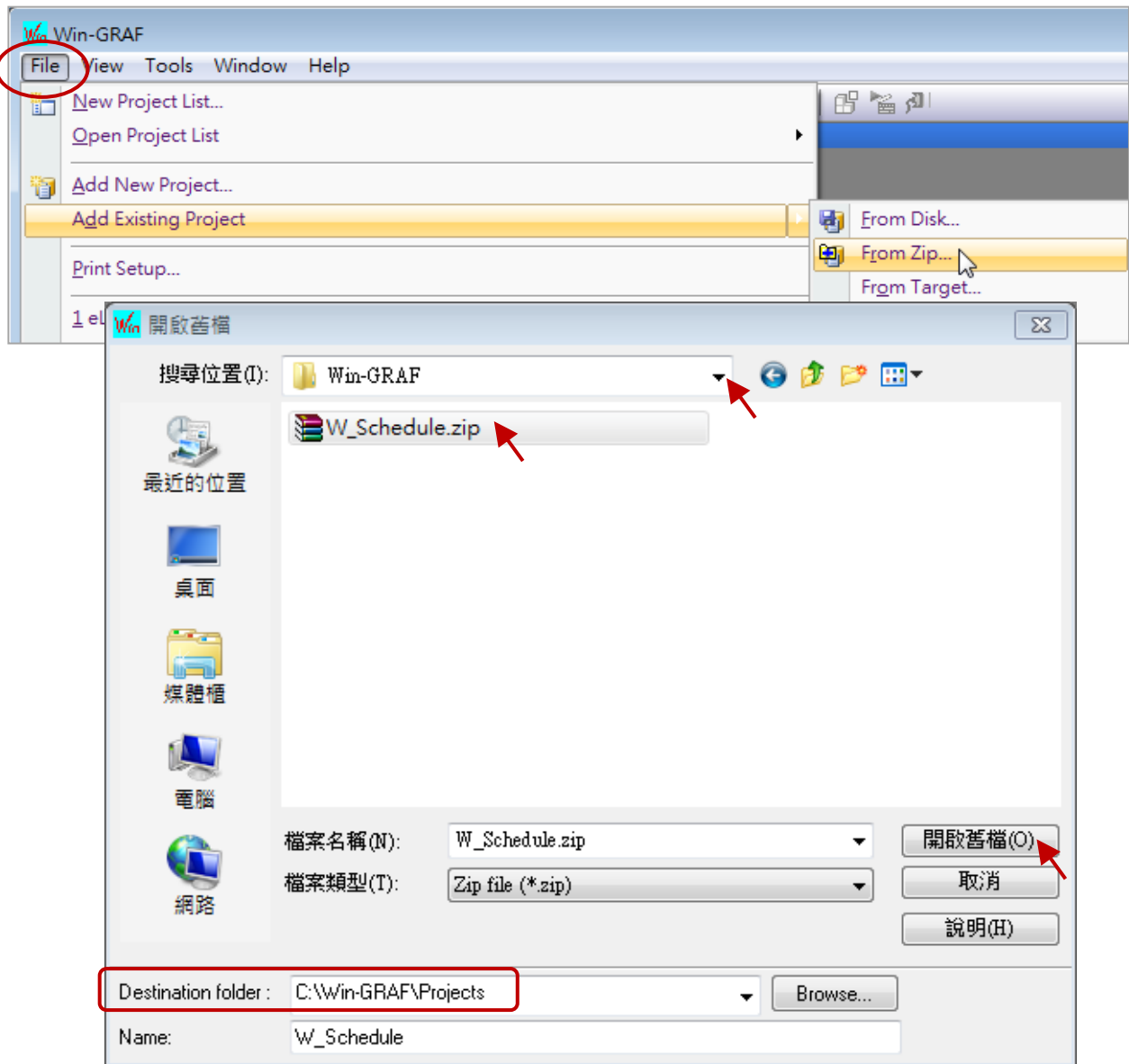

Classification	Win-GRAF English FAQ-019							
Author	Janice Hong	Version	1.0.0	Date	2017, 09	Page	17 / 40	

3.2.2. Configure the "I/O Boards"

To enable the schedule-control function in the Win-GRAF PAC, add the "Schedule" function in the I/O Boards dialog box, and double-click the "Password" parameter in the "Properties" dialog box to set the password (defaults: 0). For functioning properly, the user needs to enter a correct password when sending /receiving the schedule file by using the Schedule-Control utility on PC.

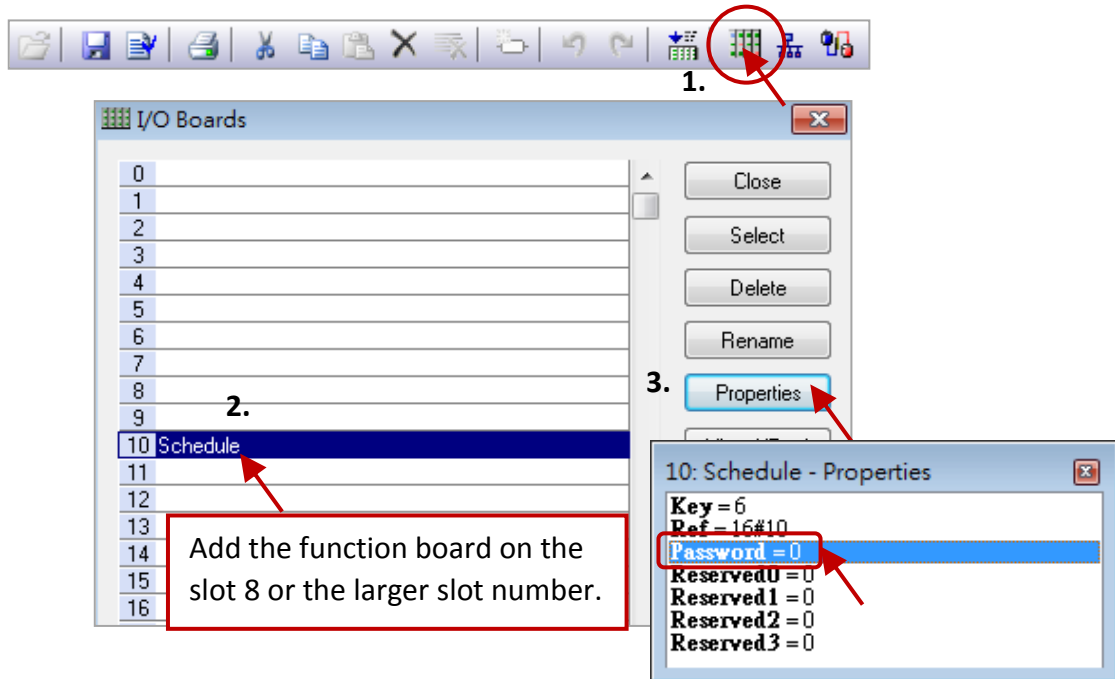

After adding the "Schedule" function board, you can see the 10 (BOOL, Input) variables which used to return the scheduling status of the targets (1 to 10) in the "Variables" screen. "TRUE" indicates that the schedule control for the target is enabled ; "FALSE" means disabled.

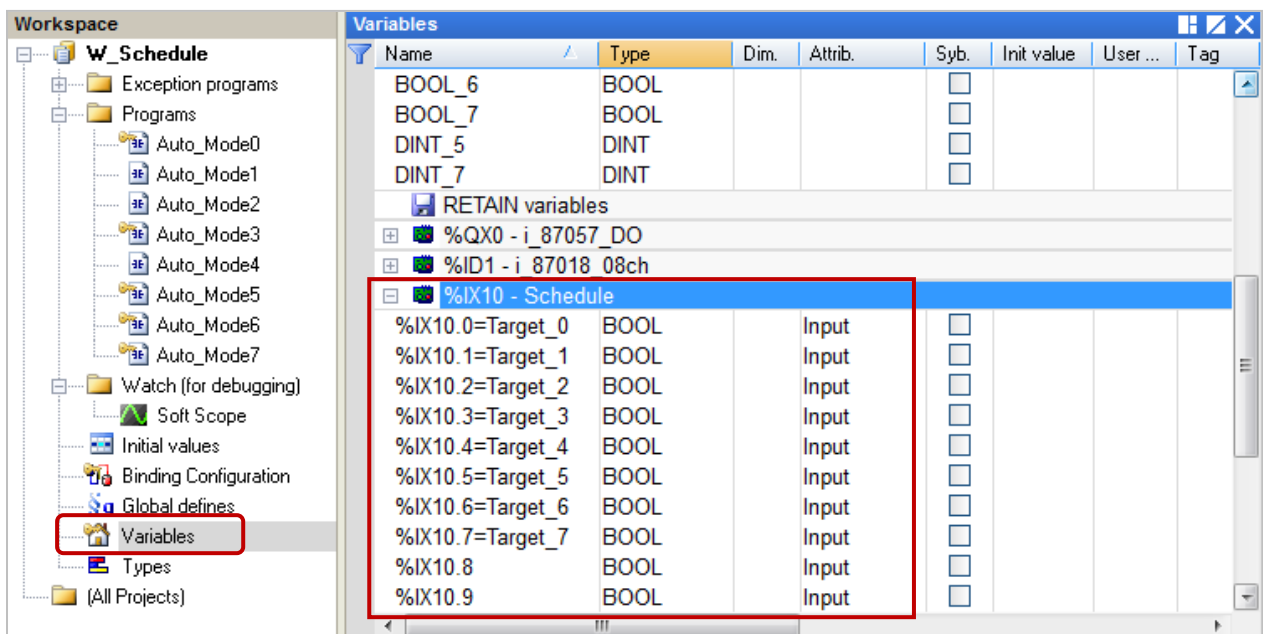

Classification	Win-GRAF English FAQ-019						
Author	Janice Hong	Version	1.0.0	Date	2017, 09	Page	18 / 40

Moreover, we use one I-87057W (Slot 0) and one I-87018RW (Slot 1) I/O modules on the Win-GRAF PAC so that we need to add two corresponding I/O Boards.

1. Double-click on the blank slot to choose these I/O boards. Then, configure the "i_87018_08ch" properties as illustrated in the figure below.

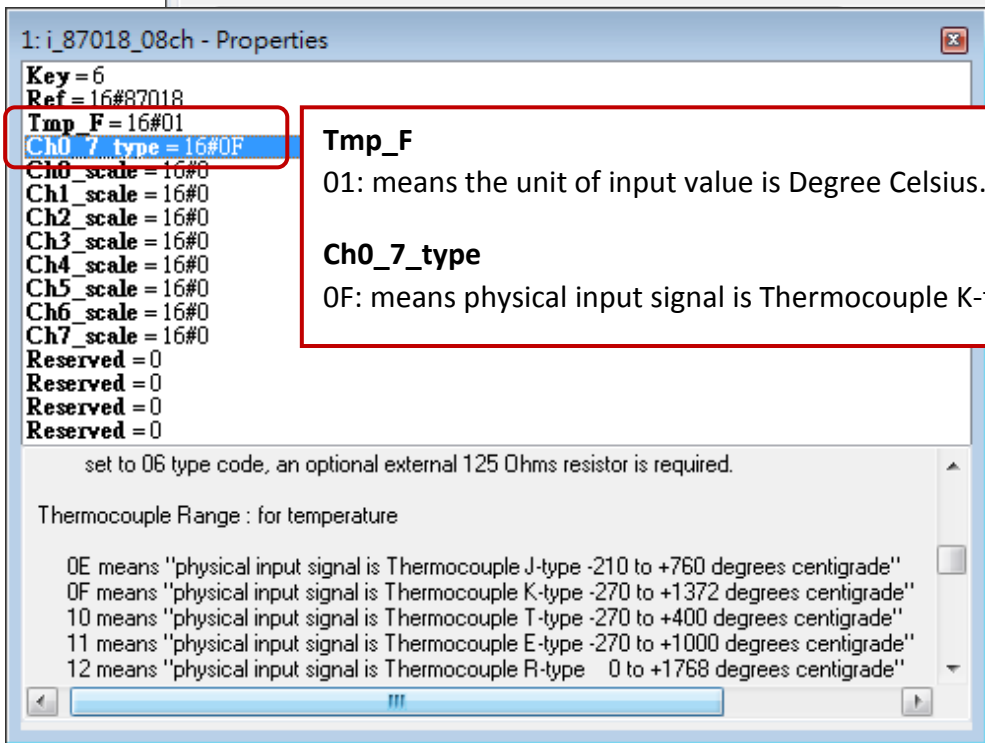
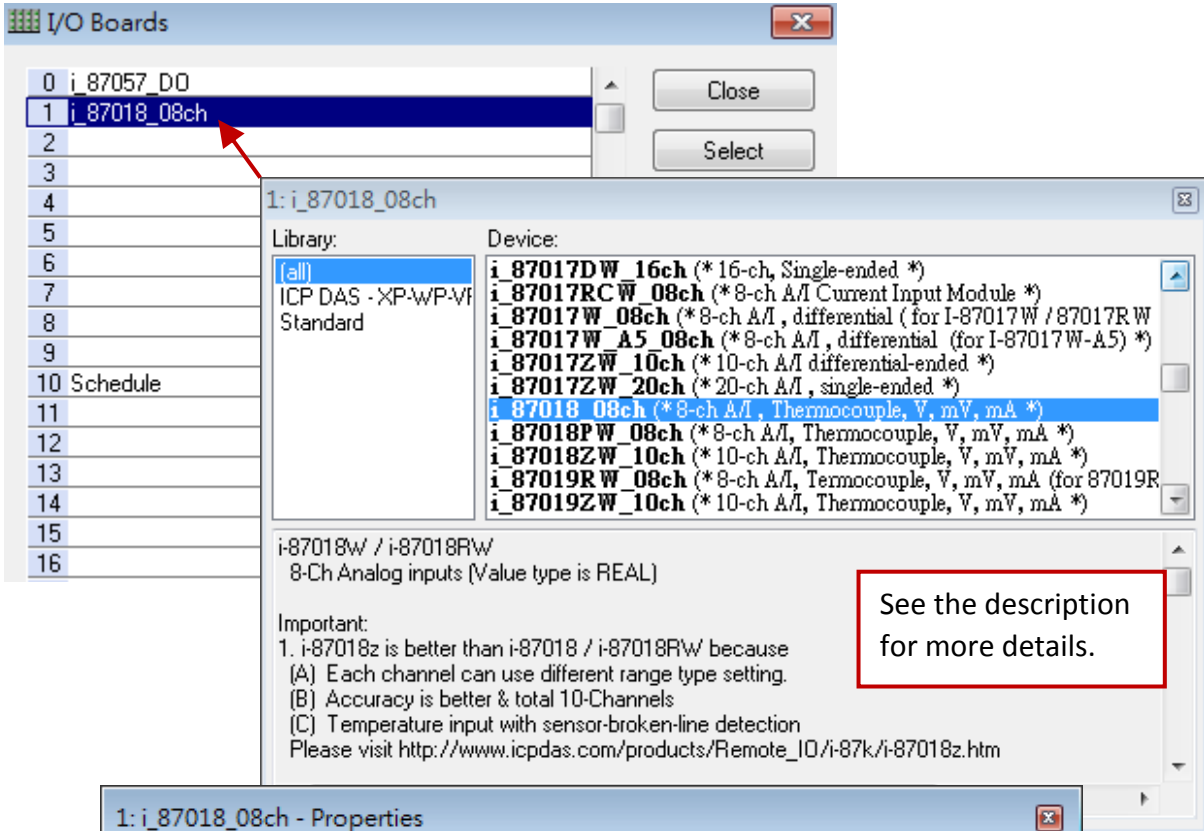

Classification	Win-GRAF English FAQ-019							
Author	Janice Hong	Version	1.0.0	Date	2017, 09	Page	19 / 40	

3.2.3. Declare the Win-GRAF Variables

The user can configure or view all declared variables in the “Variables” screen.

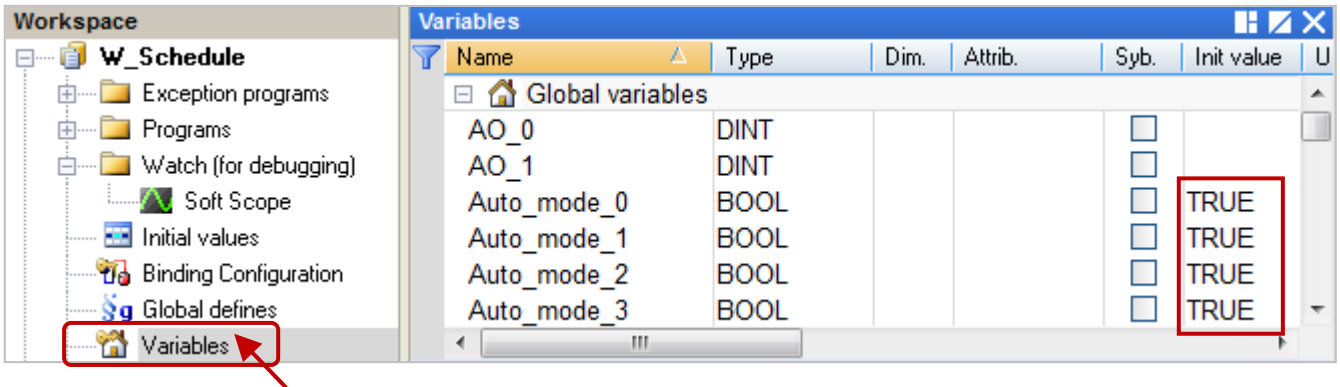

Name	Type	Description
Auto_mode_0 to Auto_mode_7	BOOL	Used to set the schedule to Auto mode or Manual mode. (Defaults: Auto, set the Init value as TRUE)
BOOL_0 to BOOL_7	BOOL	The schedule-control variables which can be used to set the statuses of the machines (3), the sprinkler (1), the lamps (2), and the air-conditioners (2) to ON/OFF .
DINT_5	DINT	The schedule-control variables which can be used to display the scheduled temperature of the air-conditioner (C1).
DINT_7		The schedule-control variables which can be used to display the scheduled temperature of the air-conditioner (C2).
AO_0	DINT	In Manual mode, it used to change he scheduled temperature of the air-conditioner (C1).
AO_1		In Manual mode, it used to change he scheduled temperature of the air-conditioner (C2).
I/O Board - "I_87057_DO" (Output)		
DO_0 to DO_7	BOOL	In Manual mode, they used to change the statuses of the machines (3), the sprinkler (1), the lamps (2), and the air-conditioners (2) to ON/OFF .
I/O Board - "i_87018_08ch" (Input)		
AI_0 to AI_1	REAL	Used to display the current indoor temperature (C1/C2).
I/O Board - "Schedule" (Input)		
Target_0 to Target_7	BOOL	Used to display the schedule status of the target. We do not use them in this case. (TRUE: enabled ; FALSE: disabled.)

Classification	Win-GRAF English FAQ-019						
Author	Janice Hong	Version	1.0.0	Date	2017, 09	Page	20 / 40

3.2.4. The Win-GRAF Program (Auto_Mode0 to Auto_Mode7)

In this example we add 8 LD programs (i.e, Auto_Mode0 to Auto_Mode7), the Auto_Mode 0 to 4 and 6 are similar only the used variables are different. By default, the Auto_mode_x is set to TRUE that means the Auto mode. When it set to FALSE, using Manual mode, you can change the status of the schedule-control variable (Boolean) by using the DO_x variable.

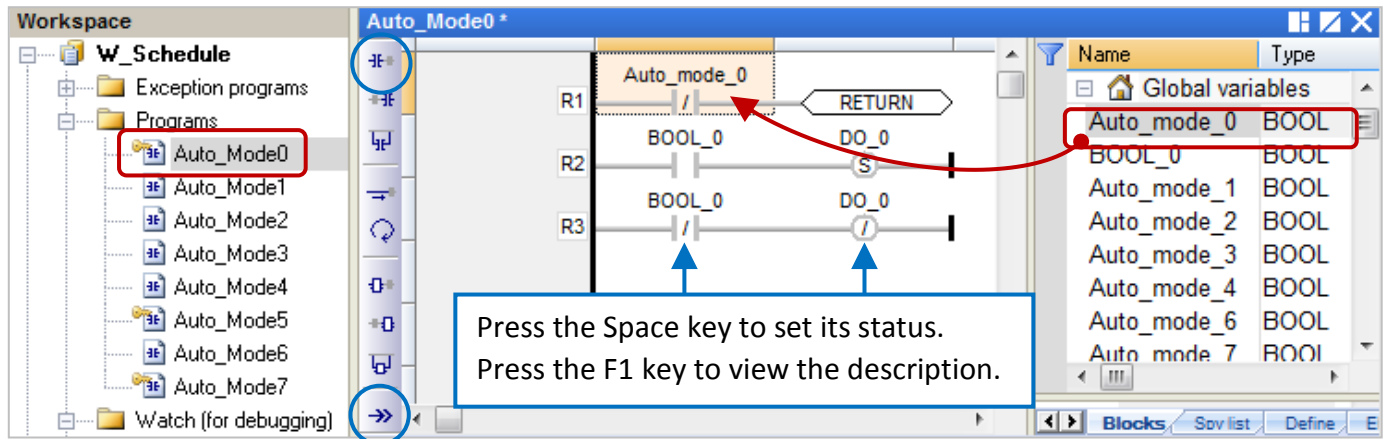

Next, the Auto_Mode 5 and 7 are similar, compared to the previous LDs, they add two more rows of components. The first row means that if it is in Auto mode (Auto_mode_x=TRUE) and the indoor temperature is larger than 30 C (AI_x > 30), the air-conditioner (C1) will be activated (BOOL_x = ON), and the scheduled temperature (T1) will be set to 28 C (DINT_x = 28). In Auto mode, normally we have set the ON/OFF time periods and the temperature for the air-conditioner (see [Section 3.1](#)). In this example, even during the OFF time period, the user can add conditions in the program to active the air-conditioner when the indoor temperature is larger than 30 C.

The 2nd row means that if it is in Manual mode (Auto_mode_x= FALSE), the user can change the value (i.e., temperature) of the schedule-control variable (DINT) by using the AO_x variable.

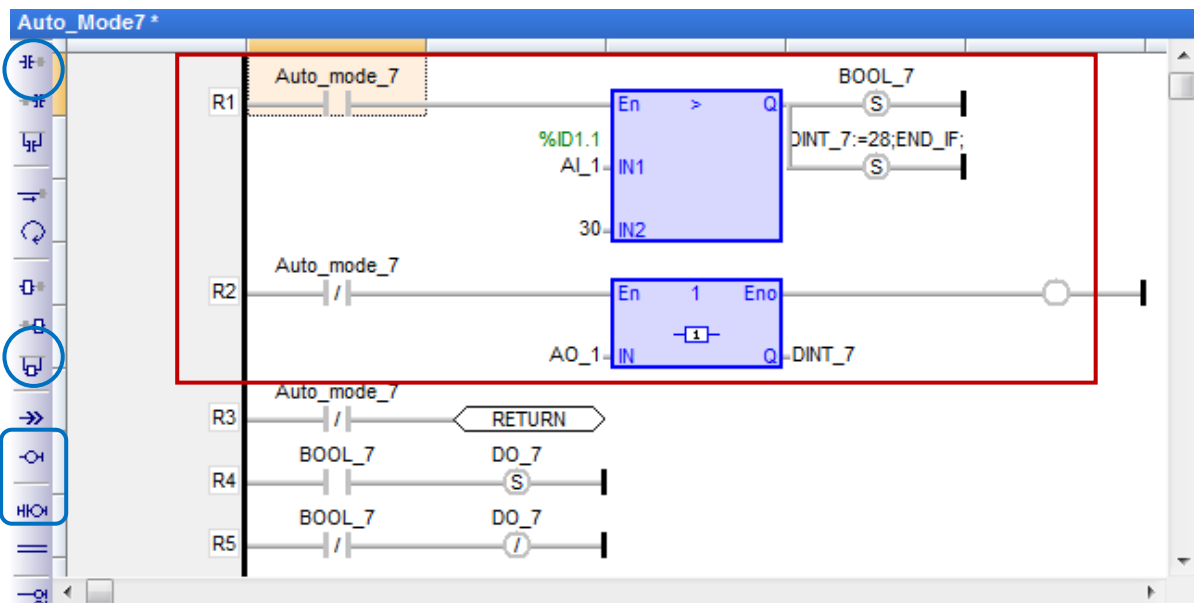

Classification	Win-GRAF English FAQ-019						
Author	Janice Hong	Version	1.0.0	Date	2017, 09	Page	21 / 40

3.2.5. Configure the Win-GRAF Variables for the eLogger HMI to Access Data

Step 1. Enable the Win-GRAF PAC as a Modbus TCP Slave Device

Click the "Open Fieldbus Configuration" button to open the "IO Drivers" window. Next, enable the Win-GRAF PAC as the Modbus TCP Slave. If you are not familiar with the operations, see Section 1.1 of the [Win-GRAF FAQ-008](#) for more details. In this example, we add three data blocks that used to share the DO, AO and AI variables.

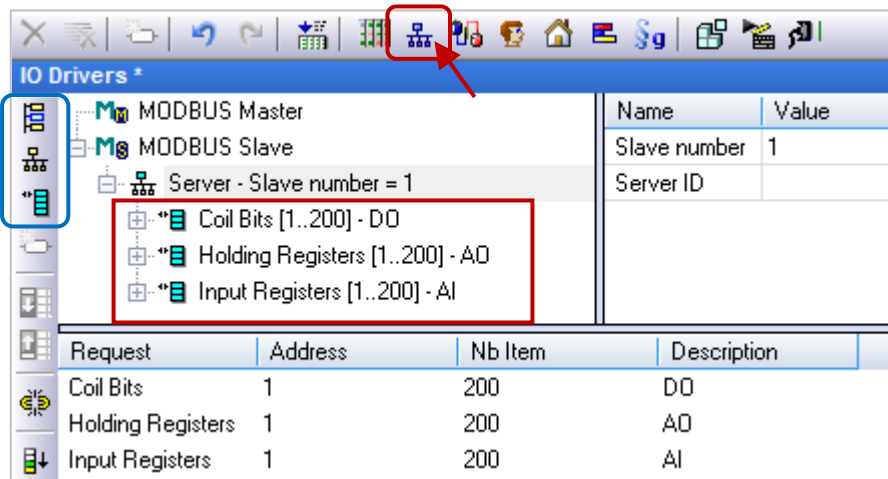

1) Data Block - Coil Bits:

Used to share the Win-GRAF Boolean variables data for communicating with the eLogger DO tags.

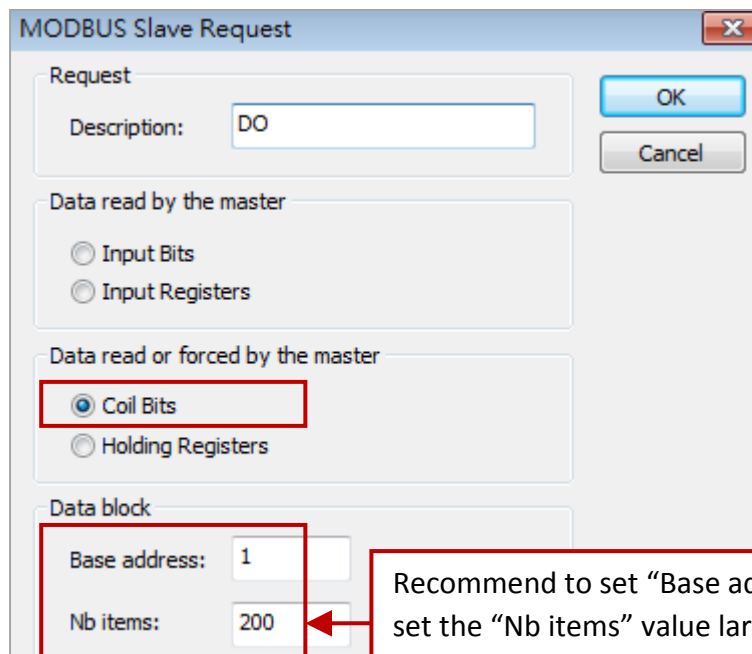

Classification	Win-GRAF English FAQ-019							
Author	Janice Hong	Version	1.0.0	Date	2017, 09	Page	22 / 40	

Dragging all needed variables from the variable area to the Symbol area of the first data block, and then set the Offset value.

Note: The Offset value starts at 0, and the Modbus address equals the Offset value plus 1. Moreover, the Modbus address of Win-GRAF variables and corresponding eLogger tags must be the same.

The screenshot shows the 'IO Drivers' configuration window. The tree view on the left shows a 'MODBUS Slave' configuration with 'Coil Bits [1..200] - DO' selected. The 'Name' and 'Value' table shows 'Coil Bits' with 'Address 1' and 'Nb Item 200'. The 'Symbol' table lists variables from DO_0 to DO_7 and Auto_mode_0 to Auto_mode_7, with their respective offsets and masks. The 'Variable' list on the right shows a list of variables including Auto_mode_0 to Auto_mode_7, BOOL_0 to BOOL_7, and DINT_5 and DINT_7. A 'RETAIN variables' section shows a list of variables with their values, including %QX0.0=DO_0, %QX0.1=DO_1, and %QX0.2=DO_2. Red boxes and arrows indicate the mapping between the symbols and the variables.

Symbol	Offset	Mask	Storage
DO_0	0	FFFF	Default
DO_1	1	FFFF	Default
DO_2	2	FFFF	Default
DO_3	3	FFFF	Default
DO_4	4	FFFF	Default
DO_5	5	FFFF	Default
DO_6	6	FFFF	Default
DO_7	7	FFFF	Default
Auto_mode_0	10	FFFF	Default
Auto_mode_1	11	FFFF	Default
Auto_mode_2	12	FFFF	Default
Auto_mode_3	13	FFFF	Default
Auto_mode_4	14	FFFF	Default
Auto_mode_5	15	FFFF	Default
Auto_mode_6	16	FFFF	Default
Auto_mode_7	17	FFFF	Default
BOOL_0	20	FFFF	Default
BOOL_1	21	FFFF	Default
BOOL_2	22	FFFF	Default
BOOL_3	23	FFFF	Default
BOOL_4	24	FFFF	Default
BOOL_5	25	FFFF	Default
BOOL_6	26	FFFF	Default
BOOL_7	27	FFFF	Default

Name	Type
Auto_mode_0	BOOL
Auto_mode_1	BOOL
Auto_mode_2	BOOL
Auto_mode_3	BOOL
Auto_mode_4	BOOL
Auto_mode_5	BOOL
Auto_mode_6	BOOL
Auto_mode_7	BOOL
BOOL_0	BOOL
BOOL_1	BOOL
BOOL_2	BOOL
BOOL_3	BOOL
BOOL_4	BOOL
BOOL_5	BOOL
BOOL_6	BOOL
BOOL_7	BOOL
DINT_5	DINT
DINT_7	DINT

Name	Value
%QX0.0=DO_0	BOOL
%QX0.10	BOOL
%QX0.11	BOOL
%QX0.12	BOOL
%QX0.13	BOOL
%QX0.14	BOOL
%QX0.15	BOOL
%QX0.1=DO_1	BOOL
%QX0.2=DO_2	BOOL

Classification	Win-GRAF English FAQ-019						
Author	Janice Hong	Version	1.0.0	Date	2017, 09	Page	23 / 40

2) Data Block – Holding Registers:

Used to share the Win-GRAF Integer and Real variables data for communicating with the eLogger AO tags. Dragging all needed variables to the Symbol area of the 2nd data block. In this case, set the Offset value as 50 to 56, and set the Storage as "DWORD [Low –High]".

- Note:** (1) The Modbus address equals the Offset value plus 1.
(2) If using a 32-bit or more data type (e.g., DINT and REAL), the variable needs to occupy 2 Modbus addresses, and the Storage field must set to "DWORD [Low –High]".

Symbol	Offset	Mask	Storage
DINT_5	50	FFFF	DWORD (Low - High)
DINT_7	52	FFFF	DWORD (Low - High)
AO_0	54	FFFF	DWORD (Low - High)
AO_1	56	FFFF	DWORD (Low - High)

3) Data Block – Input Registers:

Used to share the Win-GRAF Integer and Real variables data for communicating with the eLogger AI tags. Dragging all needed variables into the 3rd data block. In this case, set the Offset value as 30 and 32, and set the Storage as "DWORD [Low –High]".

Symbol	Offset	Mask	Storage
AI_0	30	FFFF	DWORD (Low - High)
AI_1	32	FFFF	DWORD (Low - High)

Classification	Win-GRAF English FAQ-019						
Author	Janice Hong	Version	1.0.0	Date	2017, 09	Page	24 / 40

Step 2. Configure the ID of Control Variables for each Target

A single PAC supports a maximum of 10 targets for schedule control. Each target can control three variables – one Boolean, one 32-bit Integer and one Real variable (i.e., BOOL/DINT/REAL).

If using the schedule-control function, you need to add the scheduling variables to the **Binding** screen, and set their specific identifiers, i.e., **5001 to 5030**. After downloading the Win-GRAF project to the PAC, the scheduling variable data will be applied according to the settings of the schedule-control utility.

In this example, we use 8 targets and the ID of the scheduling variables are marked in the table below.

Target	Type	ID	Target	Type	ID
The scheduling variables of Target 1	BOOL	5001	The scheduling variables of Target 6	BOOL	5016
	DINT	5002		DINT	5017
	REAL	5003		REAL	5018
The scheduling variables of Target 2	BOOL	5004	The scheduling variables of Target 7	BOOL	5019
	DINT	5005		DINT	5020
	REAL	5006		REAL	5021
The scheduling variables of Target 3	BOOL	5007	The scheduling variables of Target 8	BOOL	5022
	DINT	5008		DINT	5023
	REAL	5009		REAL	5024
The scheduling variables of Target 4	BOOL	5010	The scheduling variables of Target 9	BOOL	5025
	DINT	5011		DINT	5026
	REAL	5012		REAL	5027
The scheduling variables of Target 5	BOOL	5013	The scheduling variables of Target 10	BOOL	5028
	DINT	5014		DINT	5029
	REAL	5015		REAL	5030

Next, we will add the scheduling variables to the **Binding** screen, and set their specific identifiers.

Classification	Win-GRAF English FAQ-019						
Author	Janice Hong	Version	1.0.0	Date	2017, 09	Page	25 / 40

Click the "Open Binding Configuration" button to open the "Binding" window. Next, drag all needed variables from the Variable area into the PUBLIC and then set the identifiers of these variables.

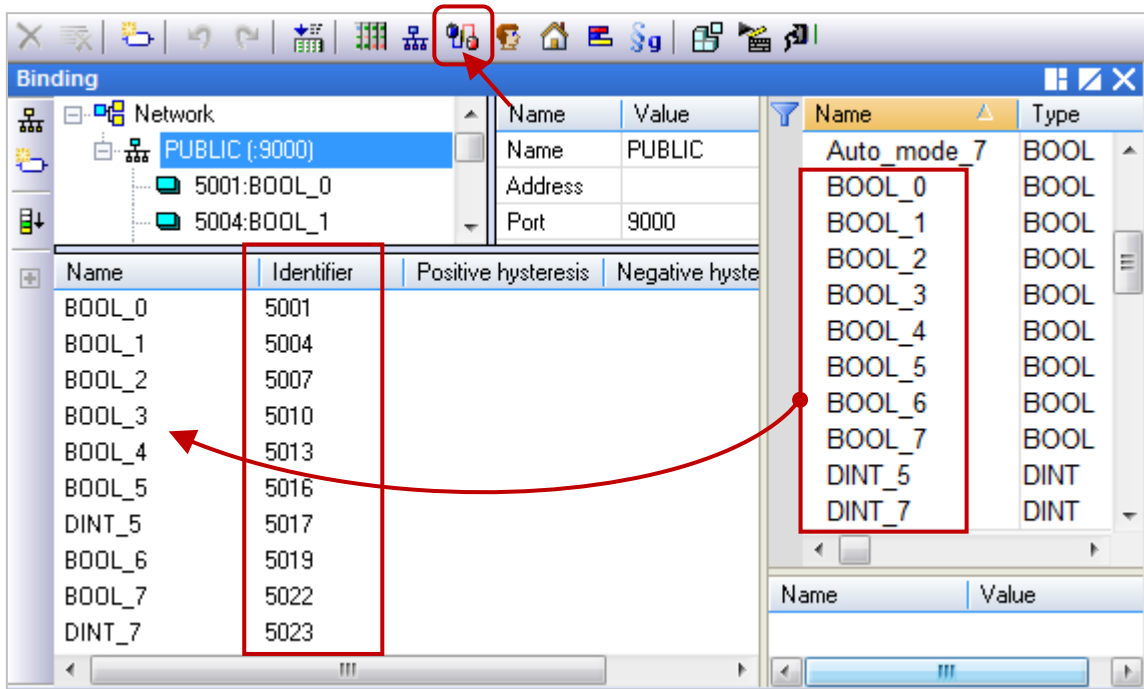

Note: All variables which added into the PUBLIC can share data to VB .net or C# or C program in the same PAC or others PAC. See [How to Exchange Data between PACs \(Data Binding\)?](#) For more information.

3.2.6. Test the Win-GRAF Project

Note: Before downloading the project to the PAC, right-click on the project name and click "Communication Parameters" to set the current IP address of the PAC. In this case, the "PAC IP: Port" is 192.168.79.150:502.

Moreover, you can create a Spy list to quickly and clearly grasp the variable data. Similarly, right-click on the project name and click "Insert New Item".

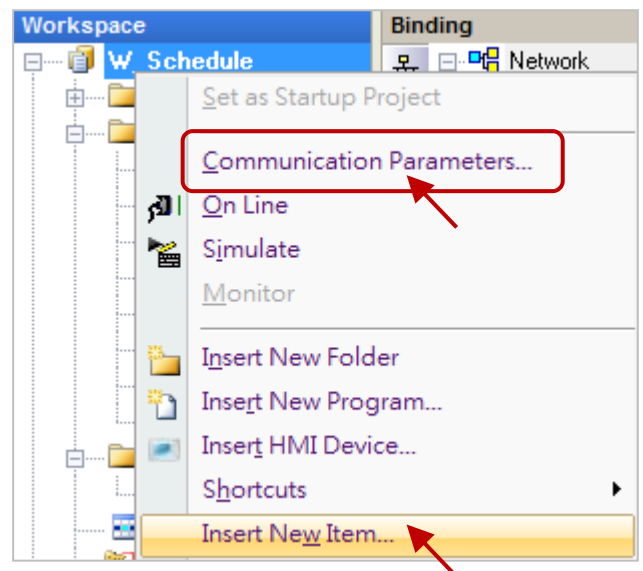

Classification	Win-GRAF English FAQ-019							
Author	Janice Hong	Version	1.0.0	Date	2017, 09	Page	26 / 40	

Next, click Watch and Spy list, and then click the Next button to display the configuration screen. Then, drag all needed variables into this screen to complete the settings.

See [Section 11.3 of the Win-GRAF User Manual](#) for more details about the Spy List.

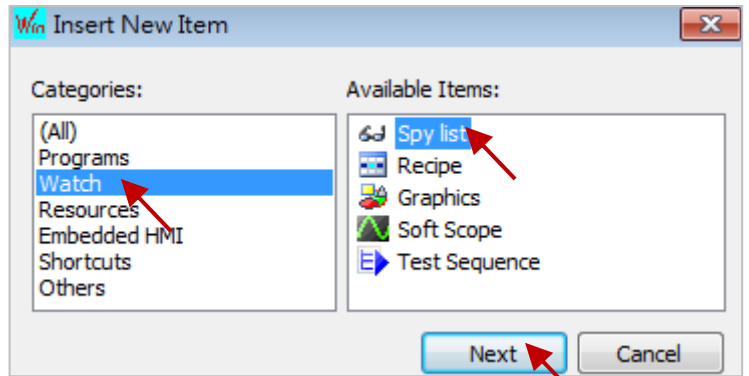

Test the Project

1. Click "On Line" to download the project to the PAC. In the spy list (NewSpy01), the status of Auto_mode_0 to 7 are "TRUE" which means Auto mode, and display value according to the Schedule-Control settings. And, the indoor temperature is 28 C (AI_x).
2. You can set the Auto_mode_5 to FALSE (Manual mode), and change the status of the DO_5 (TRUE to FALSE). And then, set the Auto_mode_5 to TRUE (Auto mode). Now, the DO_5 status will go back to the settings in the Schedule-Control utility.

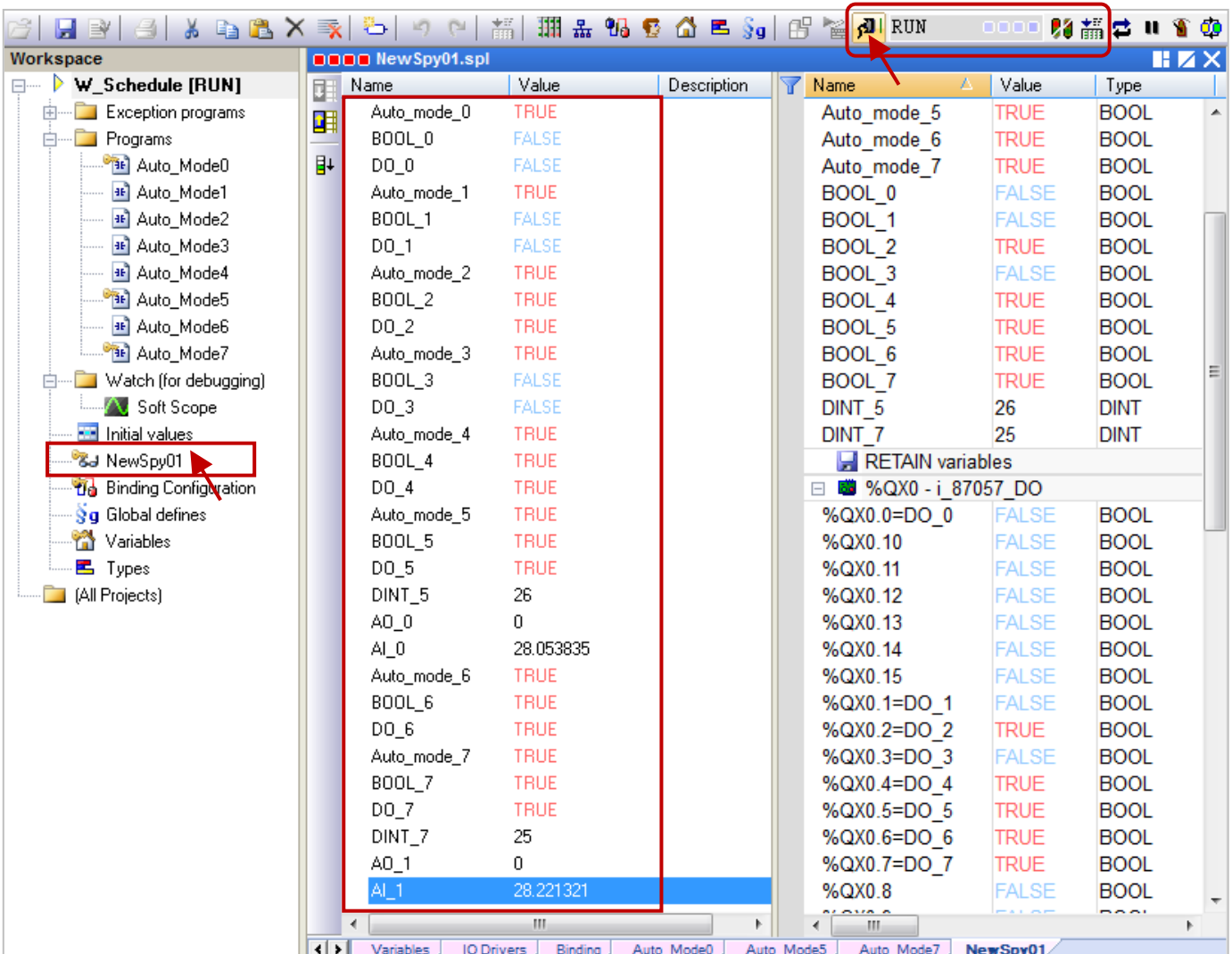

Classification	Win-GRAF English FAQ-019							
Author	Janice Hong	Version	1.0.0	Date	2017, 09	Page	27 / 40	

3.3. The eLogger Demo Programs

A single Win-GRAF PAC supports a maximum of 10 targets for the schedule control. Each target can control one Boolean, one Integer (32-bit Signed Long) and one Real (32-bit Float) variable.

Visit the www.icpdas.com > Support > FAQ > Win-GRAF Soft-Logic PAC > [FAQ-019](#) to download the eLogger project called "eL-Schedule.wez". Make sure you have installed the eLogger on your PC and PAC. If you are not familiar with the eLogger, see the [eLogger User Manual](#) or [Win-GRAF FAQ-018](#) : How to Use Win-GRAF SoftLogic and eLogger HMI in the Win-GRAF PAC?

First, execute the eLogger Developer, and click Project and Open to open an existing project called eL-Schedule.wez.

Note: By default, the eLogger projects are stored in the C:\ICPDAS\eLogger\eLogger_Developer\Project.

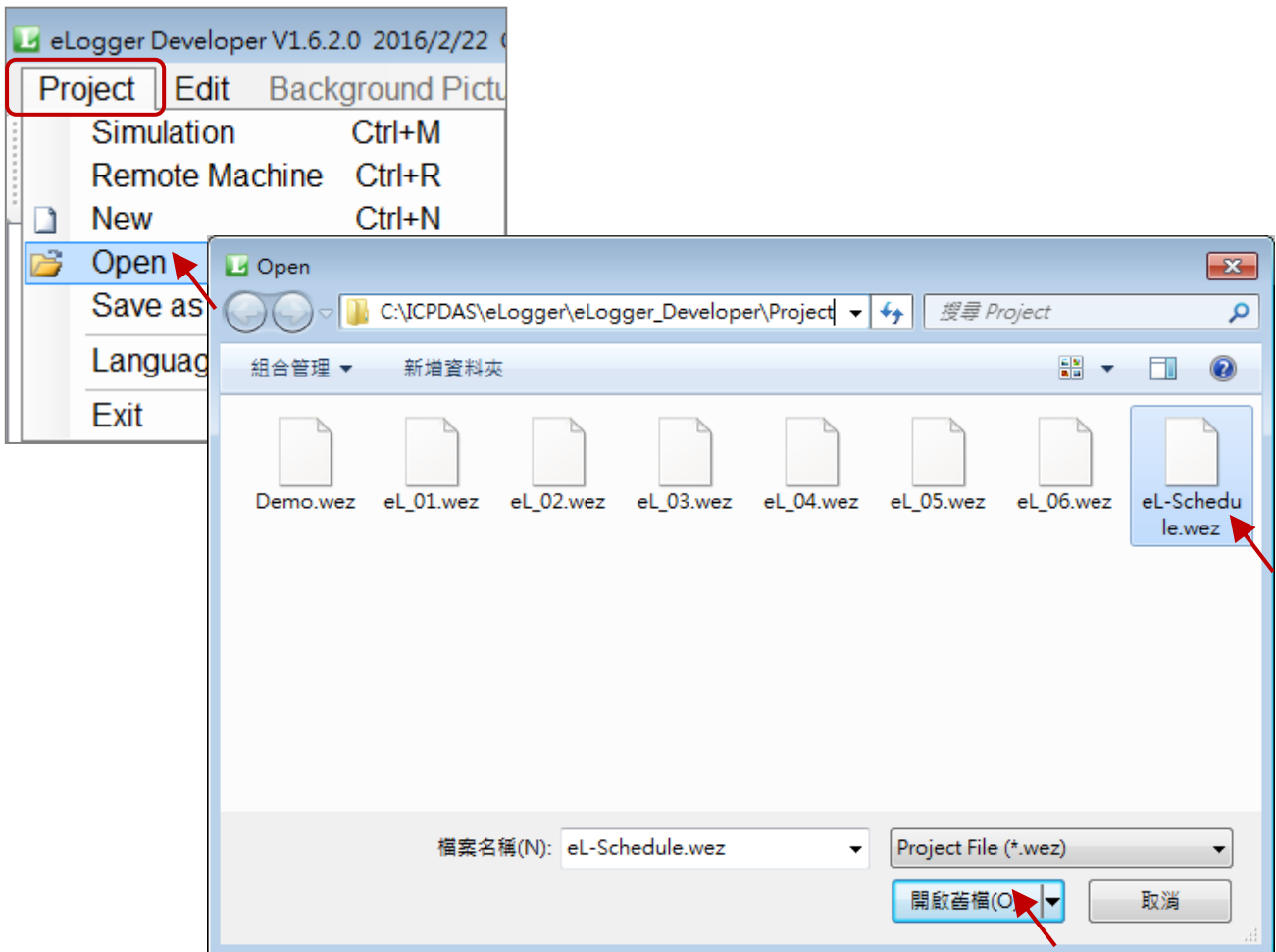

Classification	Win-GRAF English FAQ-019						
Author	Janice Hong	Version	1.0.0	Date	2017, 09	Page	28 / 40

3.3.1. Install the Modbus TCP Driver

For operating with the Win-GRAF SoftLogic, the eLogger needs to install the Modbus TCP Driver.

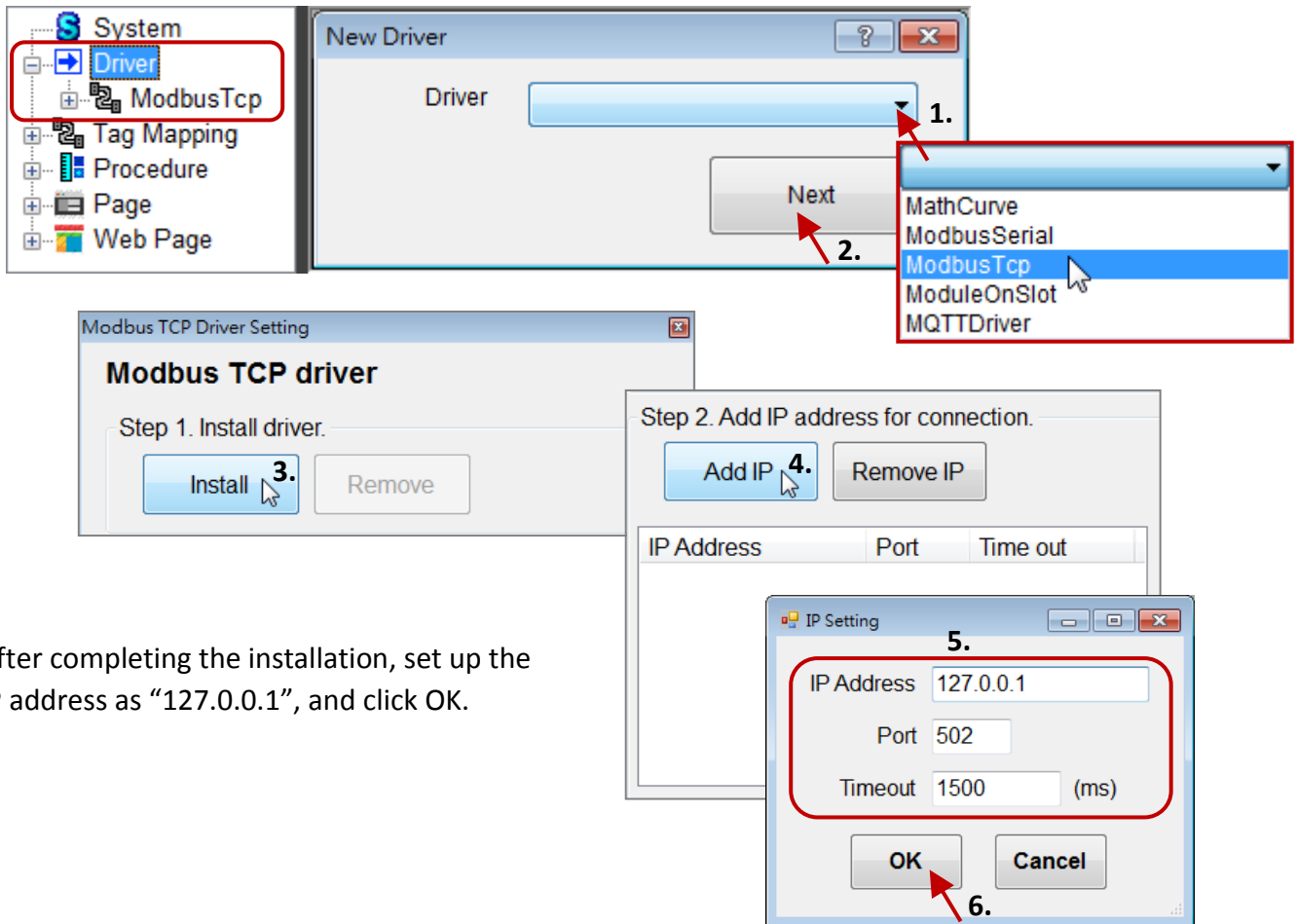

After completing the installation, set up the IP address as “127.0.0.1”, and click OK.

3.3.2. Declare Modbus Addresses

eLogger Tags and Win-GRAF variables are communicating each other via the Modbus address. In [Section 3.2.5](#), we publish the following Win-GRAF variables and Modbus addresses.

Win-GRAF Variables	Modbus Address
DO0 to DO7	1 to 8
Auto_mode_0 to Auto_mode_7	11 to 18
BOOL_0 to BOOL_7	21 to 28
AI_0 to AI_1	31 to 34
DINT_5, DINT_7	51 to 54
AO_0 to AO_1	55 to 58

Note: The Modbus address equals the Offset value plus 1, and the DINT or REAL variable needs to occupy 2 Modbus addresses.

Classification	Win-GRAF English FAQ-019						
Author	Janice Hong	Version	1.0.0	Date	2017, 09	Page	29 / 40

Next, click "Add Device" to define the range of the Modbus address as follows.

Step 3. Add Device

Add Device Cancel

Device Setting

Device Information

Connect from IP 127.0.0.1

Device Name

Station Address 1

Registers Setting 1.

Add Register Remove Register

Register Definition List

If you want to delete the address, click "Remove Register".

Registers Setting

Module Enter Register Description Enter the register range.

Address Range Definition 2.

Base 0(Absolute addresses) Base 1(Modbus addresses) 3.

0xxxx Coil Status(R/W)	<input checked="" type="checkbox"/>	00101	TO	00110
1xxxx Input Status(R)	<input checked="" type="checkbox"/>	10001	TO	10020
3xxxx Input Registers(R)	<input type="checkbox"/>		TO	
4xxxx Holding Registers(R/W)	<input checked="" type="checkbox"/>	40201	TO	40255

Done 5.

OK 4. Cancel

Register Definition List

00101~00110
10001~10020
40201~40255

If you need to add the address afterwards, click Add Register again, and remember to click **Modify** after completing the settings.

Done Modify Remove Cancel

Classification	Win-GRAF English FAQ-019						
Author	Janice Hong	Version	1.0.0	Date	2017, 09	Page	30 / 40

3.3.3. Declare eLogger Tags

After setting the Modbus address range, the eLogger will automatically create a mapping list for the Modbus address and the Memory address as the figure below. eLogger Tags and Win-GRAF variables are communicating each other via the Modbus address. To declare eLogger variables, you need to set the memory address correspond with the Modbus address which you set before in the Win-GRAF.

AI Tag: (Data Type: 32-bit Float)

Memory Address	Name	Location
InputRegister[0]	30031	ModbusTcp->127.0.0.1_ID1->30031
InputRegister[1]	30032	ModbusTcp->127.0.0.1_ID1->30032
InputRegister[2]	30033	ModbusTcp->127.0.0.1_ID1->30033

Tag Name	Description	Memory Address	Data Type
AI0	AI0	0	32-bit Float

Used to communicate with the Win-GRAF variables - AI_0 (31), AI_1 (33).

Tag Name	Description	Memory Address	Data Type
AI0	AI0	0	32-bit Float
AI1	AI1	2	32-bit Float

AO Tag: (Data Type: 32-bit Signed Long)

Memory Address	Name	Location
HoldingRegister[0]	40051	ModbusTcp->127.0.0.1_ID1->40051
HoldingRegister[1]	40052	ModbusTcp->127.0.0.1_ID1->40052
HoldingRegister[2]	40053	ModbusTcp->127.0.0.1_ID1->40053

Tag Name	Description	Memory Address	Data Type
DO0	DO_0	0	32-bit Signed Long

Used to communicate with the Win-GRAF variables - DINT_5 (51), DINT_7 (53), AO_0 (55), AO_1 (57).

Tag Name	Description	Memory Address	Data Type
DINT_5	DINT_5	0	32-bit Signed Long
DINT_7	DINT_7	2	32-bit Signed Long
AO_0	AO_0	4	32-bit Signed Long
AO_1	AO_1	6	32-bit Signed Long

Classification	Win-GRAF English FAQ-019							
Author	Janice Hong	Version	1.0.0	Date	2017, 09	Page	31 / 40	

DO Tag:

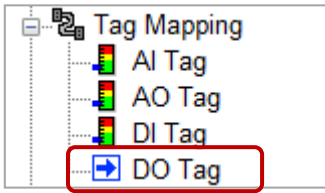

Memory Address	Name	Location
00001	CoilStatus[0]	ModbusTcp->127.0.0.1_ID1->00001
00002	CoilStatus[1]	ModbusTcp->127.0.0.1_ID1->00002
00003	CoilStatus[2]	ModbusTcp->127.0.0.1_ID1->00003
00004	CoilStatus[3]	ModbusTcp->127.0.0.1_ID1->00004

Tag Name	Description	Memory Address
DO0	DO_0	0

Tag Name	Description	Memory Address
DO0	DO_0	0
DO1	DO_1	1
DO2	DO_2	2
DO3	DO_3	3
DO4	DO_4	4
DO5	DO_5	5
DO6	DO_6	6
DO7	DO_7	7
Auto_Mode_0	Auto_0	10
Auto_Mode_1	Auto_1	11
Auto_Mode_2	Auto_2	12
Auto_Mode_3	Auto_3	13
Auto_Mode_4	Auto_4	14
Auto_Mode_5	Auto_5	15
Auto_Mode_6	Auto_6	16
Auto_Mode_7	Auto_7	17
BOOL_0	BOOL_0	20
BOOL_1	BOOL_1	21
BOOL_2	BOOL_2	22
BOOL_3	BOOL_3	23
BOOL_4	BOOL_4	24
BOOL_5	BOOL_5	25
BOOL_6	BOOL_6	26
BOOL_7	BOOL_7	27

Used to communicate with the Win-GRAF variables - DO_0 to DO_7 (1 - 8), Auto_mode_0 to Auto_mode_7 (11 - 18), BOOL_0 to BOOL_7 (21 - 28).

Classification	Win-GRAF English FAQ-019							
Author	Janice Hong	Version	1.0.0	Date	2017, 09	Page	32 / 40	

3.3.4. Design the eLogger HMI

The eLogger project includes two Pages (called Schedule and Auto/Manual Mode) and two Web Pages (Login, Home) that apply in three kinds of application field (e.g., factory, lawn, and Home).

Page - Schedule : Used to display the status (or value) of the device. (Default: Auto mode).

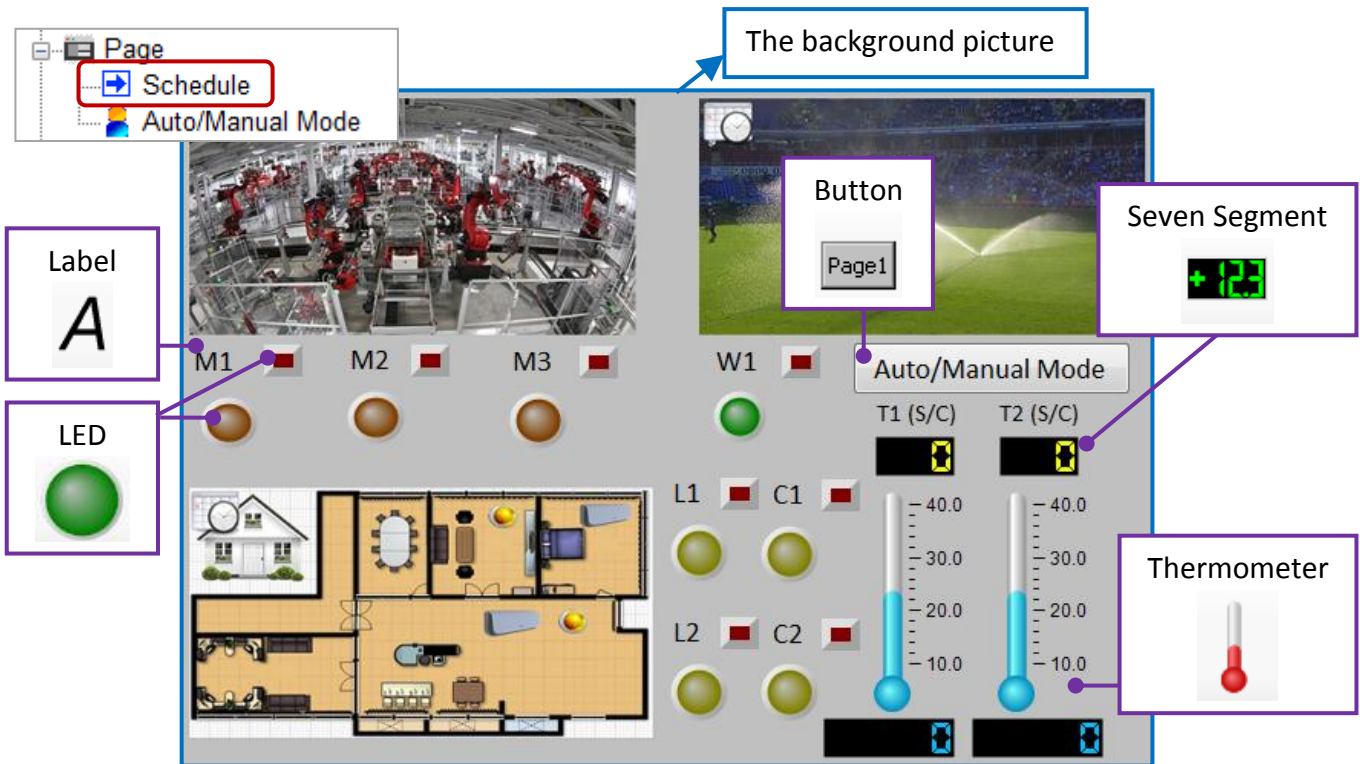

Component - LED

1. The red LED is used to display whether the scheduling is during "ON" periods.

Devices	DO Tags
M1 to M3	BOOL_0 to BOOL_2
W1	BOOL_3
L1, L2	BOOL_4, BOOL_6
C1, C2	BOOL_5, BOOL_7

So you can know the original status of the scheduling even if it is set to the Manual mode.

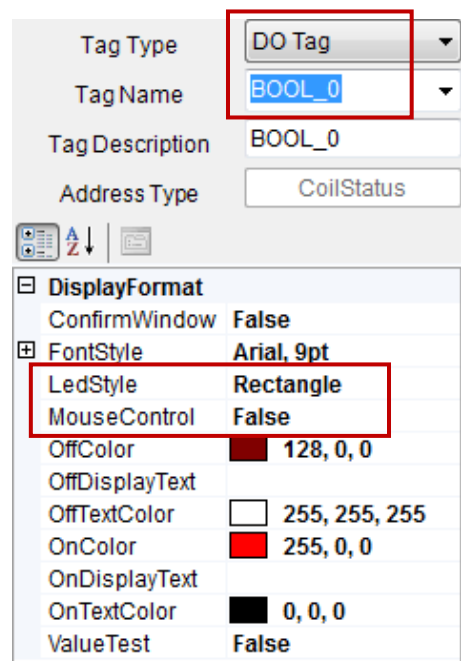

Classification	Win-GRAF English FAQ-019						
Author	Janice Hong	Version	1.0.0	Date	2017, 09	Page	33 / 40

2. The rest of LEDs are used to display the device status.

Devices	DO Tags
M1 to M3	DO_0 to DO_2
W1	DO_3
L1, L2	DO_4, DO_6
C1, C2	DO_5, DO_7

Component - Seven Segment

T1(S) and T2(S) are used to display the scheduled temperature.
T1(C) and T2(C) are used to display the indoor temperature.

Devices	AO / AI Tag
T1(S), T2(S)	DINT_5, DINT_7
T1(C), T2(C)	AI0, AI1

Classification	Win-GRAF English FAQ-019						
Author	Janice Hong	Version	1.0.0	Date	2017, 09	Page	34 / 40

Component - Thermometer

T1(C) and T2(C) are used to display the current indoor temperature.

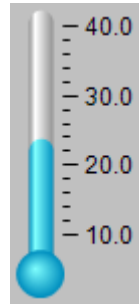

Configuration panel for the Thermometer component:

- Tag Type: AI Tag
- Tag Name: AI1
- Tag Description: AI1
- Output Limit(Min): -10.0
- Output Limit(Max): 10.0
- Address Type: InputRegister
- Address: 1
- Data Type: 32-bit Float
- Gain: 1
- Offset: 0
- Range: --
- DisplayFormat:
 - Back_Color: 192, 192, 192
 - Fore_Color: 0, 191, 255
 - MouseControl: False
 - ScaleMax: 40
 - ScaleMin: 10
 - TestValue: 23.5

Devices	AI Tags
T1(C), T2(C)	AI0, AI1

Component - Button

The "Auto/Manual Mode" button is used to display the configuration page.

Configuration panel for the Button component:

- Button Type: SwitchPage
- Switch Page To: Auto/Manual Mode
- DisplayFormat:
 - DisplayText: Auto/Manual Mode
 - FontStyle: Calibri, 14.25pt
 - Fore_Color: 0, 0, 0

Page - Auto/Manual Mode:

This page is used to set the scheduling between Auto Mode or Manual Mode. you can also change the status of the device or the scheduled temperature.

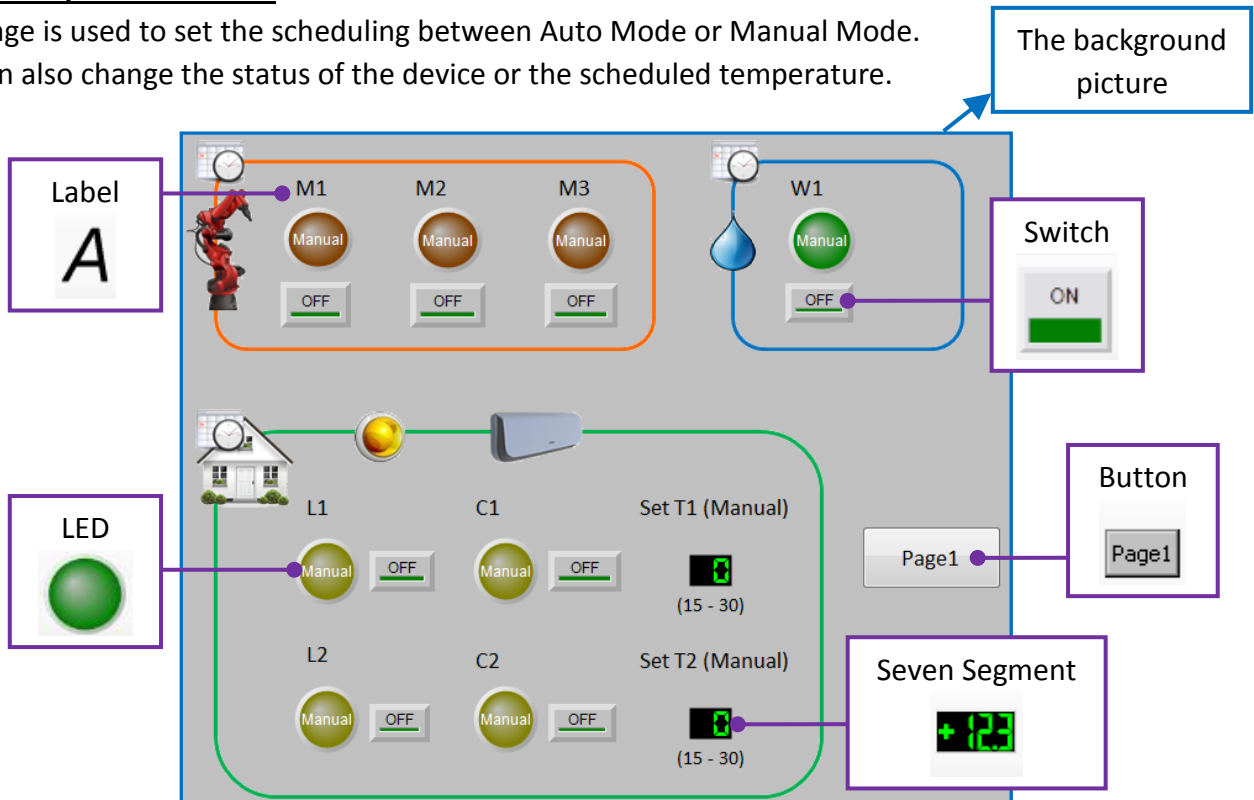

Classification	Win-GRAF English FAQ-019							
Author	Janice Hong	Version	1.0.0	Date	2017, 09	Page	35 / 40	

Component - LED

Used to set the scheduling as the Auto or Manual mode.

Component - Switch

In Manual mode, used to change the device status.

Devices	DO Tags (LED)	DO Tags (Switch)
M1 to M3	Auto_Mode_0 to Auto_Mode_2	DO_0 to DO_2
W1	Auto_Mode_3	DO_3
L1, L2	Auto_Mode_4, Auto_Mode_6	DO_4, DO_6
C1, C2	Auto_Mode_5, Auto_Mode_7	DO_5, DO_7

Tag Type: DO Tag
 Tag Name: Auto_Mode_0
 Tag Description: Auto_0
 Address Type: CoilStatus

DisplayFormat:
 ConfirmWindow: False
 FontStyle: Arial, 9pt
 LedStyle: Ellipse
 MouseControl: True
 OffColor: 128, 64, 0
 OffDisplayText: Manual
 OffTextColor: 255, 255, 255
 OnColor: 255, 128, 0
 OnDisplayText: Auto
 OnTextColor: 0, 0, 0
 ValueTest: False

Tag Type: DO Tag
 Tag Name: DO0
 Tag Description: DO_0
 Address Type: CoilStatus

DisplayFormat:
 ConfirmWindow: False
 FontStyle: Arial, 9pt
 MouseControl: True
 OffColor: 0, 127, 0
 OffDisplayText: OFF
 OnColor: 0, 255, 0
 OnDisplayText: ON
 ValueTest: False

Component - Button

Used to go to the "Schedule" page.

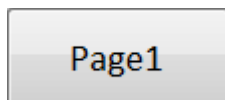

Button Type: SwitchPage
 Switch Page To: Schedule

DisplayFormat:
 DisplayText: Page1
 FontStyle: Calibri, 14.25pt
 Fore_Color: 0, 0, 0

Classification	Win-GRAF English FAQ-019						
Author	Janice Hong	Version	1.0.0	Date	2017, 09	Page	36 / 40

Component - Seven Segment

In Manual mode, used to change the scheduled temperature of the device.

Devices	AO Tags
Set T1	AO_0
Set T2	AO_1

Tag Type: AO Tag

Tag Name: AO_0

Tag Description: AO_0

Output Limit(Min): 15.0

Output Limit(Max): 30.0

Address Type: HoldingRegister

Address: 2

Data Type: 32-bit Signed Long

Gain: 1

Offset: 0

Range: -2147483648.000~21

DisplayFormat

Decimal: 0

DigitalNumber: 2

Font_Color: 0, 255, 0

Font_OffColor: 0, 0, 0

MouseControl: True

Show_Sign: False

TestValue: 0

3.3.5. Design the eLogger Web Page

This eLogger project includes two Web Pages called Login and Home. "Login" is the default page. The "Home" page can be used to remotely control the switch of lamps and air-conditioners also the scheduled temperature in home by logging to the Web Server HMI via the smart device, e.g., a smart phone, a tablet, or a laptop.



The background picture

Label: A

Home

Log Out

Button: Page1

Picture Toggle

Light: L1, L2

Air Condition: C1, C2

Seven Segment: +12.3

Classification	Win-GRAF English FAQ-019						
Author	Janice Hong	Version	1.0.0	Date	2017, 09	Page	37 / 40

Component - Picture Toggle

Used to control the switch of lamps and air-conditioners in home.

Lamps	DO Tags (LED)	Air-conditioners	DO Tags (LED)
L1	DO_4, Auto_Mode_4	C1	DO_5, Auto_Mode_5
L2	DO_6, Auto_Mode_6	C2	DO_7, Auto_Mode_7

Click the "OffPicture" or the "OnPicture" button to choose an image in the eLogger.
 (Location: C:\ICPDAS\eLogger\eLogger_Developer\WebPic)

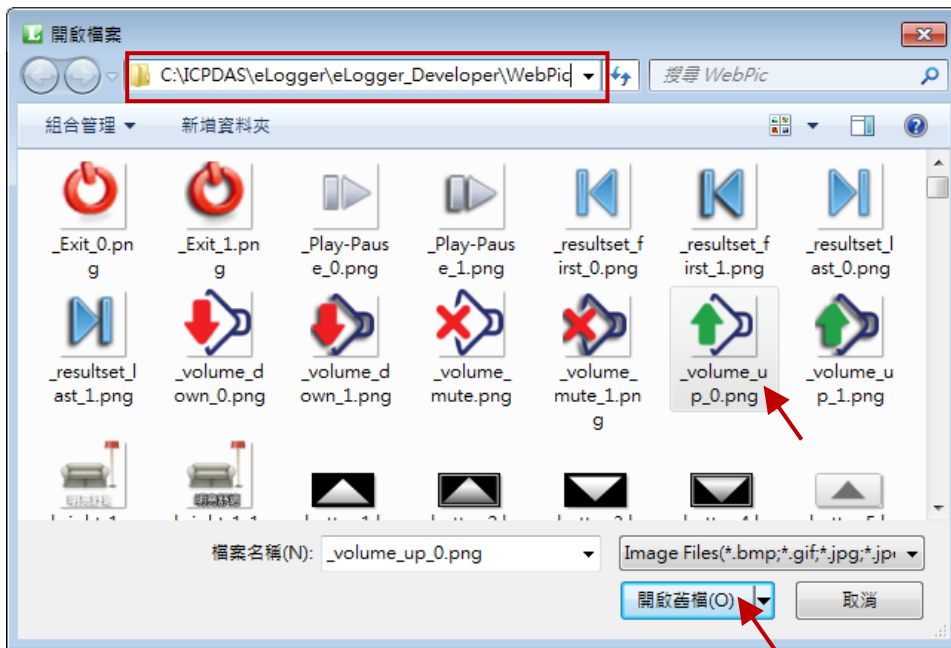

Classification	Win-GRAF English FAQ-019							
Author	Janice Hong	Version	1.0.0	Date	2017, 09	Page	38 / 40	

Component - Button

Used to logout the "Home" page.

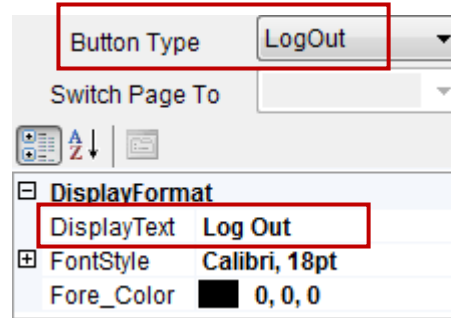
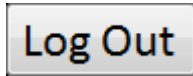

Component - Seven Segment

In Manual mode, used to change the scheduled temperature of the device.

Devices	AO / AI Tag
T1(S), T2(S)	DINT_5, DINT_7
T1(C), T2(C)	AI0, AI1

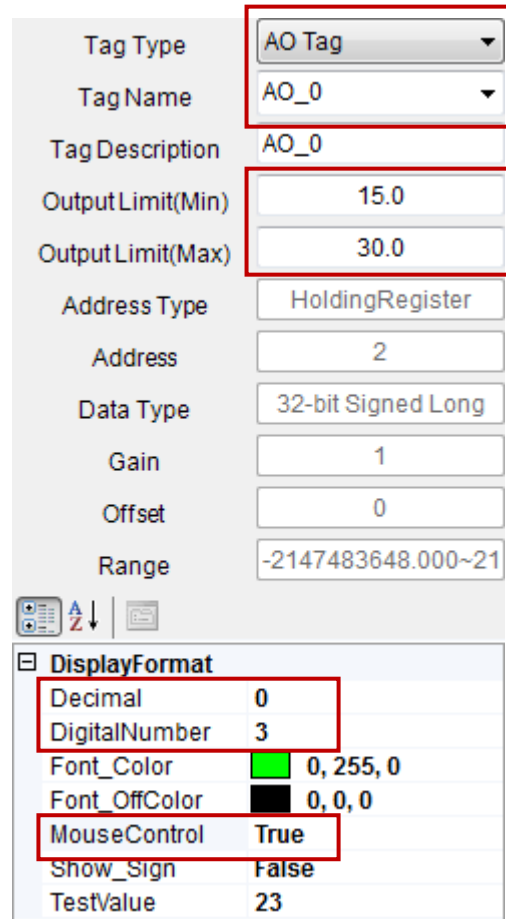
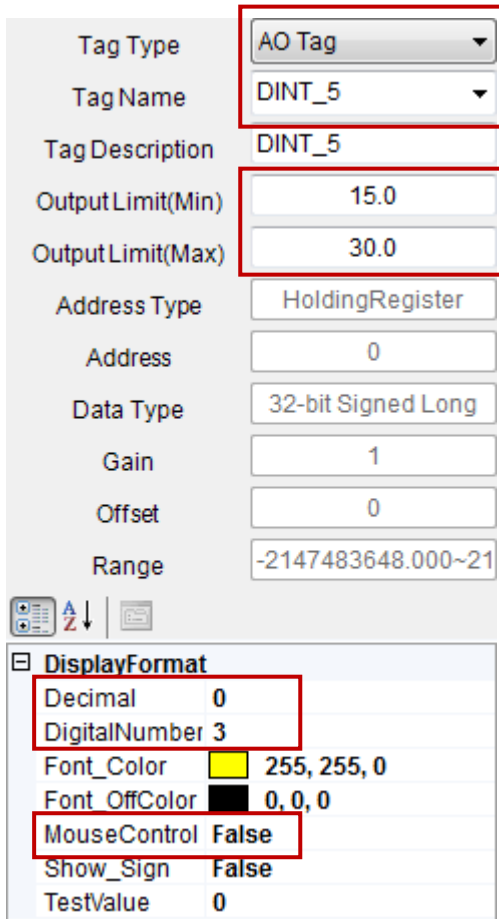

Classification	Win-GRAF English FAQ-019						
Author	Janice Hong	Version	1.0.0	Date	2017, 09	Page	39 / 40

3.3.6. Test the eLogger Project

If you have not installed the eLogger Runtime on your PAC, see Chapter 2 of the [Win-GRAF FAQ-018](#) for more details. Moreover, add the `\System_Disk\eLogger\RuntimeCE7.exe` path in the Auto Execution screen of the PAC Utility. If the **RuntimeCE7.exe** is not activated, you cannot upload the eLogger project to the PAC.

Moreover, you can click My Device on PAC desktop and execute " **RuntimeCE7.exe**" in the `\System_Disk\eLogger\`.

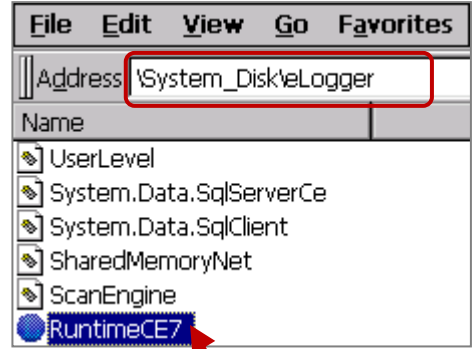

Next, run the Remote Machine in the eLogger Developer on PC, and enter the IP address of the PAC, and then click "Upload Project & Web Pages" to upload the project to the PAC. Note that it can not function well if the **RuntimeCE7.exe** is not activated.

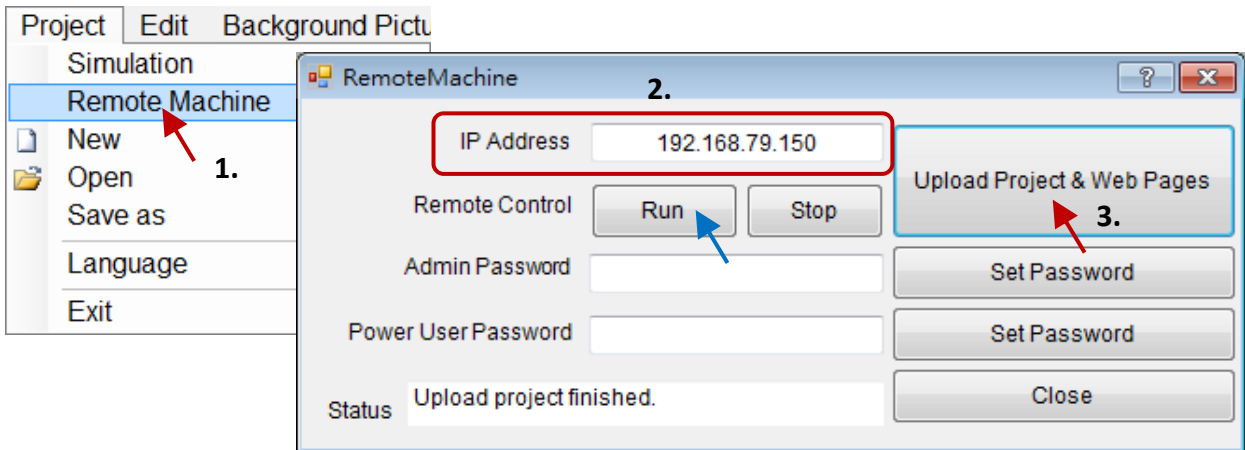

If you upload successfully, the eLogger Runtime on PAC will display the project name (eL-Schedule.wez).

Note:

Recommended to set the HTTP root as `\System_Disk\www` in the Network screen of the PAC Utility. Then, copy the eLogger web folders to this folder.

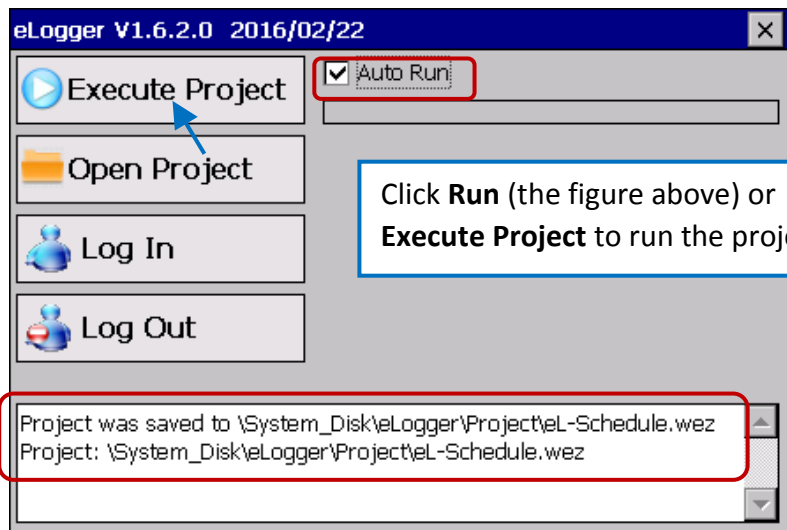

Classification	Win-GRAF English FAQ-019						
Author	Janice Hong	Version	1.0.0	Date	2017, 09	Page	40 / 40

Test the Project (eL-Schedule.wez)

As you can see, the status and temperature of the device are displayed depends on the scheduled settings, and the indoor temperatures are 29 C and 28 C.

Page

Note: The Schedule page is only to display the status of device.

1. You can connect the K-Type wire to the channel 0 (or 1) of the I-87018RW module, and check to see if the C1 (or C2) is set to ON and the T1 (or T2) is set to 28 when the indoor temperature is larger than 30 C.
2. Click the "Auto/Manual Mode" button to display the configuration screen.
3. You can click the "Auto" button to change it to Manual mode, and then click ON/OFF button to change the status or set a new scheduled temperature.

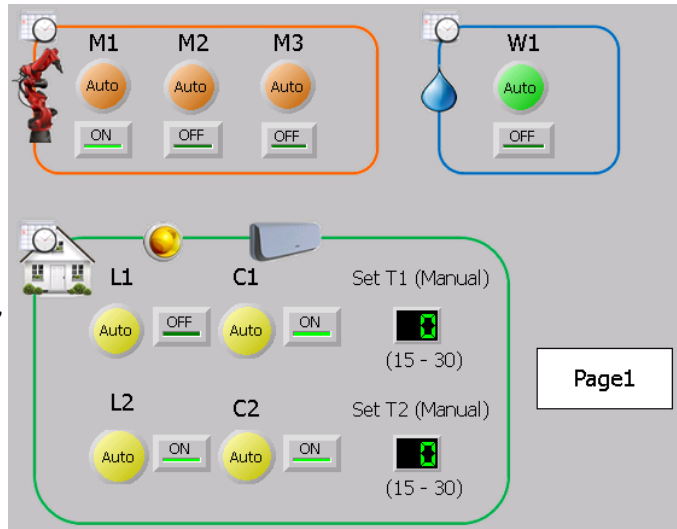
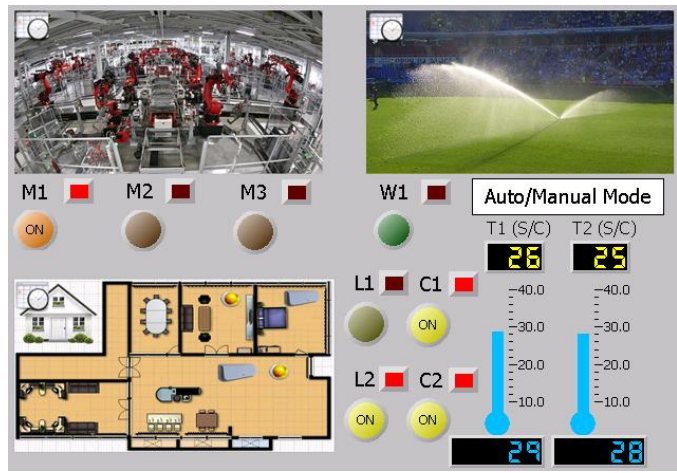

Web Page

1. Type the IP address of the PAC on a web browser, and then enter the username and password (default: admin/0000) to login to the page.
2. Set to the manual scheduling (green arrow) and try to change the status and value.

