

# Industrial Quad-band GPRS/GSM Modem

## GTM-201 Series

### User Manual

#### **Warranty**

All products manufactured by ICP DAS are warranted against defective materials for a period of one year from the date of delivery to the original purchaser.

#### **Warning**

ICP DAS assumes no liability for damages consequent to the use of this product. ICP DAS reserves the right to change this manual at any time without notice. The information furnished by ICP DAS is believed to be accurate and reliable. However, no responsibility is assumed by ICP DAS for its use, or for any infringements of patents or other rights of third parties resulting from its use.

#### **Copyright**

Copyright 2009 by ICP DAS Co., LTD. All rights reserved worldwide.

#### **Trademark**

The names used for identification only may be registered trademarks of their respective companies.

# Table of Contents

<b>Chapter 1 Introduction .....</b>	<b>3</b>
<b>Chapter 2 Hardware Specifications .....</b>	<b>4</b>
2.1 GTM-201 Series .....	4
2.2 GTM-201 Specifications .....	5
<b>Chapter 3 Application architecture .....</b>	<b>7</b>
3.1 Application 1.....	7
3.2 Application 2.....	7
3.3 Application 3.....	8
3.4 Application 4.....	8
<b>Chapter 4 Hardware Appearance .....</b>	<b>9</b>
4.1 View of the GTM-201-RS232 and GTM-201-USB Panel..	9
4.2 Pin Assignments .....	10
4.3 Hardware Dimensions .....	11
4.4 LED indicators .....	12
<b>Chapter 5 Hardware Wire Connection .....</b>	<b>13</b>
5.1 Reset Wire Connection.....	13
5.2 GSM/GPRS Installation.....	14
5.3 Quick Test .....	15
<b>Chapter 6 GPRS connection.....</b>	<b>21</b>
6.1 XPAC – 8000 (Microsoft Windows XP) .....	21
6.2 WinPAC-8000 (WinCE) .....	36
6.3 LinPAC – 8000 (Linux) .....	47
<b>Chapter 7 USB driver installation .....</b>	<b>51</b>
7.1 XPAC – 8000 (Microsoft Windows XP) .....	51
7.2 WinPAC – 8000 (WinCE) .....	59
7.3 LinPAC – 8000 (Linux) .....	60
<b>Chapter 8 Software Reset .....</b>	<b>61</b>
8.1 Software Reset (for GTM-201-RS232).....	61

# Chapter 1 Introduction

The GTM-201 series are industrial Quad-band GSM/GPRS modems with RS-232 and USB interfaces that work on frequencies of GSM 850 MHz, EGSM 900 MHz, DCS 1800 MHz and PCS 1900 MHz. The modems utilize the GSM/GPRS network for convenient and inexpensive data transfer from remote instruments, meters, computers or control systems in either live data or packet data. GTM-201 series have the integrated TCP/IP stack so that even simple controllers with serial communications ports can be connected to the modem without the need for special driver implementation. With the features of GTM-201 series, the systems can be SMS and GPRS connection applications with various PLC and PC. Moreover, with the voice interface, these modems can also be applied to the alarm system with sounds.

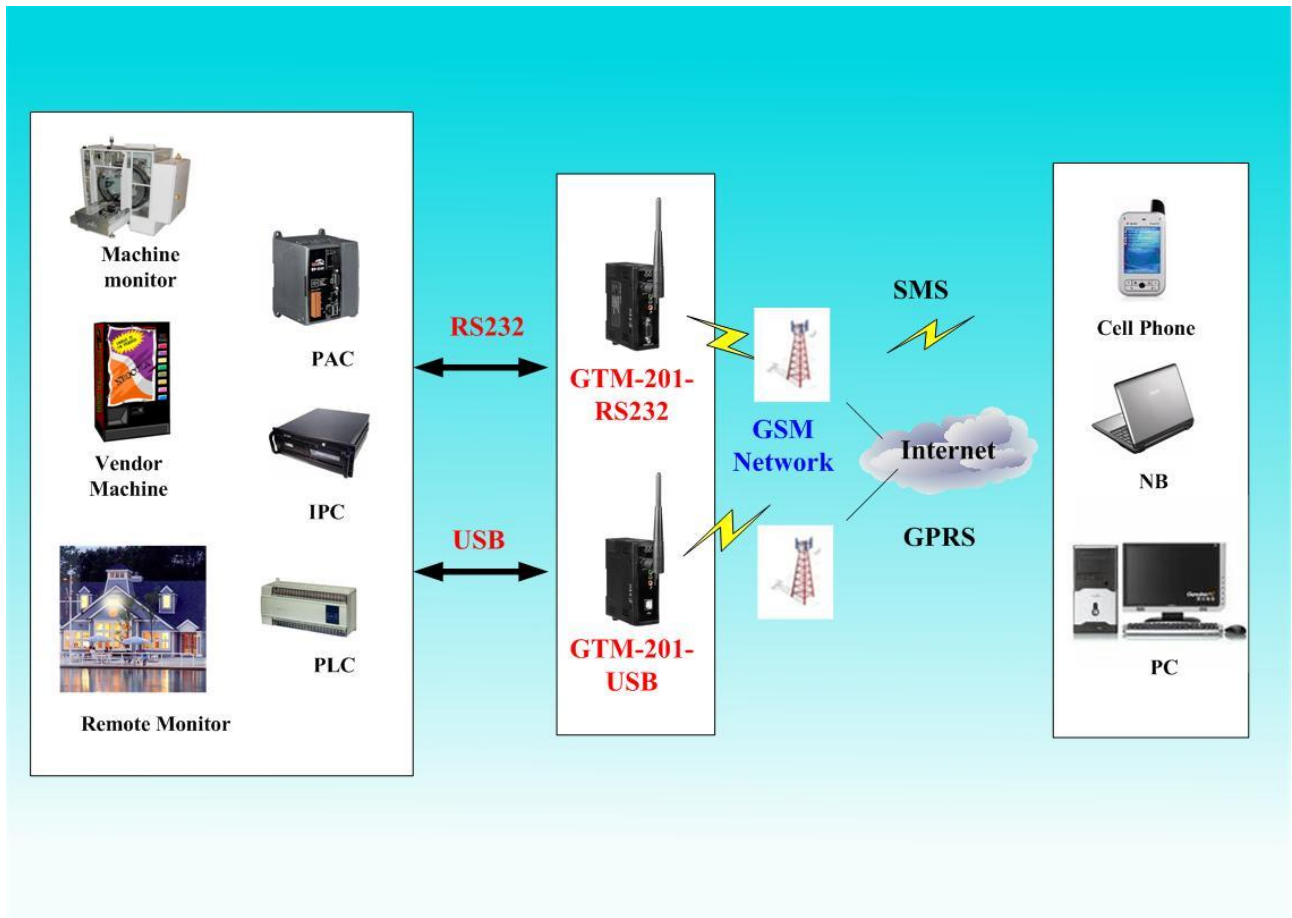

## Chapter 2 Hardware Specifications

### 2.1 GTM-201 Series



## 2.2 GTM-201 Specifications

Models	GTM-201-RS232	GTM-201-USB
GSM/GPRS System		
GPRS/GSM Quad-band	850/900/1800/1900 MHz	
GPRS Multi-slot	Class 10/8	
GPRS Mobile Station	Class B	
GPRS Class 10	Max. download speed 85.6 kbps	
CSD	Up to 14.4 kbps	
Compliant to GSM Phase 2/2+	Class 4 (2 W @ 850/900 MHz); Class 1 (1 W @ 1800/1900 MHz)	
Coding Schemes	CS 1, CS 2, CS 3, CS 4	
SMS	Text and PDU Mode	
Serial Ports		
Serial Standards	RS-232 (DB9 Female)	USB (B-TYPE) to RS232(VCP)
RS-232	TxD, RxD, RTS, CTS, DTR, DSR, DCD, RI, GND	TxD, RxD, DTR, DSR, DCD, RI, GND
Baud Rate	9600 bps ~ 115200 bps	
Include Cable	RS-232 9-Pin Female to Male cable(CA-0915)	USB Type A to Type B cable (CA-USB18)
Compatibility	-	USB 1.1 and 2.0 standard
USB Driver Support	-	<ul style="list-style-type: none"> <li>● Windows 98 and 2000</li> <li>● Windows XP and XP 64-bit</li> <li>● Windows Vista and Vista 64-bit</li> <li>● <a href="#">WinPAC</a>(WinCE 5.0)</li> <li>● <a href="#">LinPAC</a>(Linux kernel 2.6)</li> </ul>
Reset Input		
Input Type	Isolated, 3750 V <sub>rms</sub>	
On Voltage Level	+3.5 V <sub>DC</sub> ~ +30 V <sub>DC</sub>	
Off Voltage Level	+1V max.	
Input Impedance	3 kΩ, 0.25 W	
LED Indicators		
Power	Red color	
GSM/GPRS	Green color	
Power		
Protection	Power reverse polarity protection	

Frame Ground Protection	ESD, Surge, EFT, Hi-Pot
Required Supply Voltage	+10 V <sub>DC</sub> ~ +30 V <sub>DC</sub>
Power Consumption	Idle: 25 mA @ 24 V <sub>DC</sub> ; Data Link: 100 ~ 400 mA (peak) @ 24 V <sub>DC</sub>
Connection	5-Pin 3.81 mm Removable Terminal Block
Mechanical	
Casing	Plastic
Flammability	UL 94V-0 materials
Dimensions (W x L x H)	33 mm x 87 mm x 107 mm
Installation	DIN-Rail
Environment	
Operating Temperature	-25 °C ~ +55 °C
Storage Temperature	-40 °C ~ +80 °C
Humidity	5 ~ 95% RH, non-condensing

**Note1: The baud rate of GTM-201-RS232 and GTM-201-USB are default in 115200 bps.**

## Chapter 3 Application architecture

### 3.1 Application 1

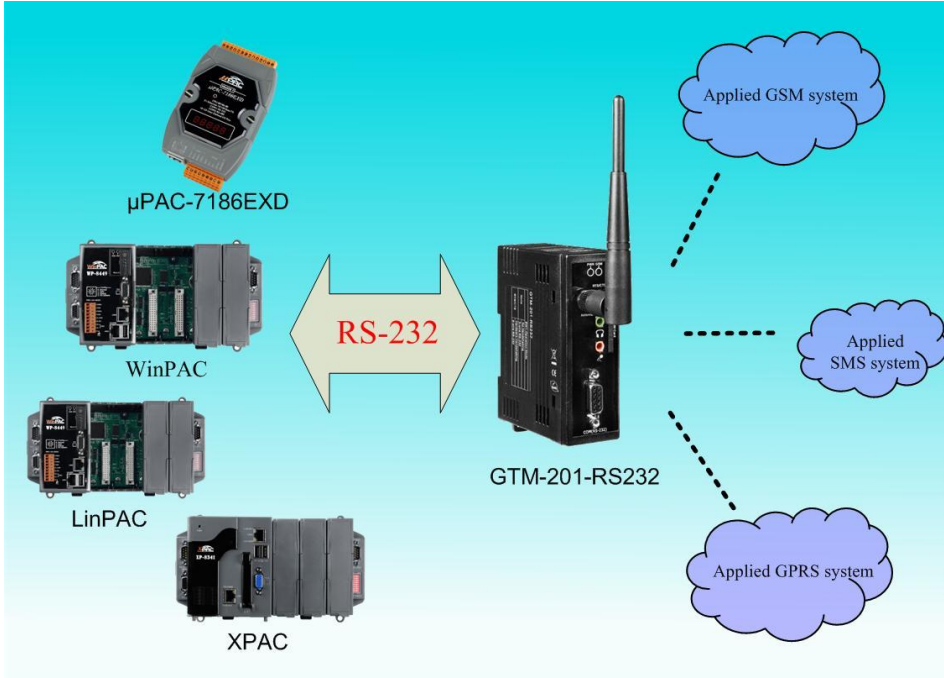

### 3.2 Application 2

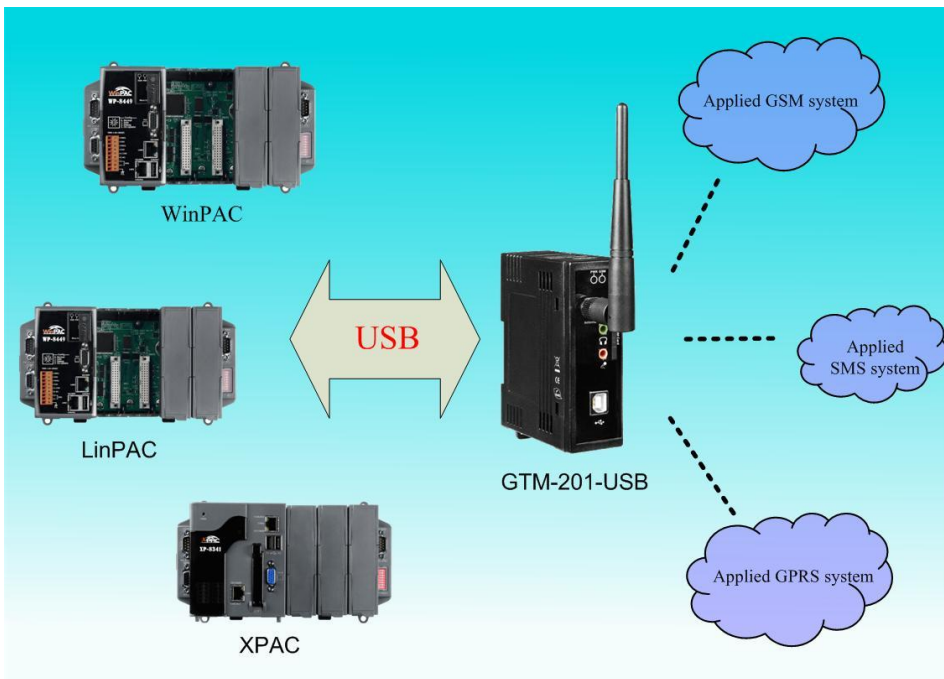

### 3.3 Application 3

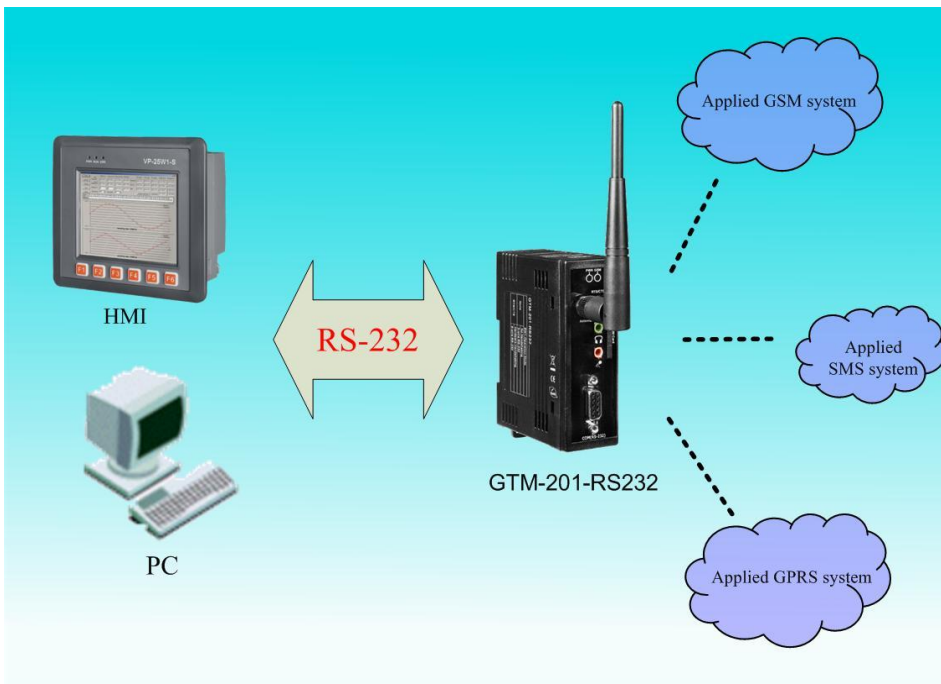

### 3.4 Application 4

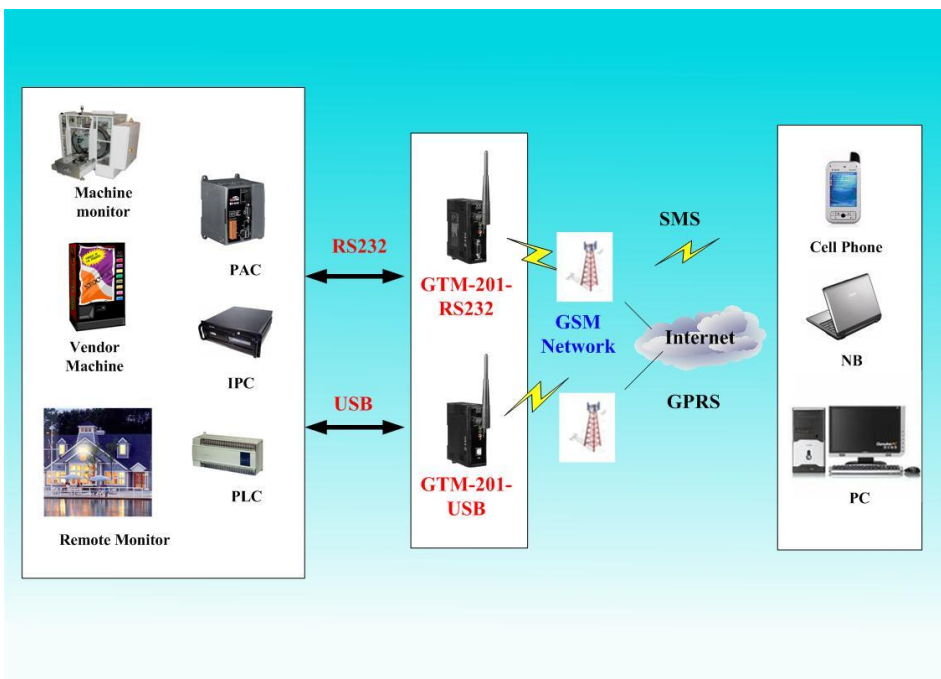



## Chapter 4 Hardware Appearance

### 4.1 View of the GTM-201-RS232 and GTM-201-USB Panel

➤ **GTM-201-RS232 :**

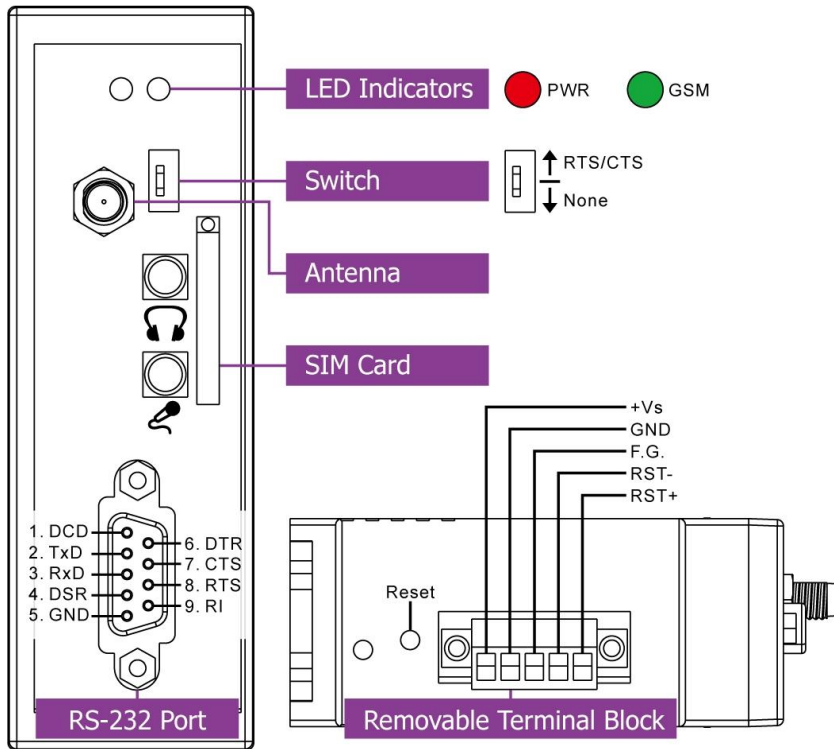

➤ **GTM-201-USB :**

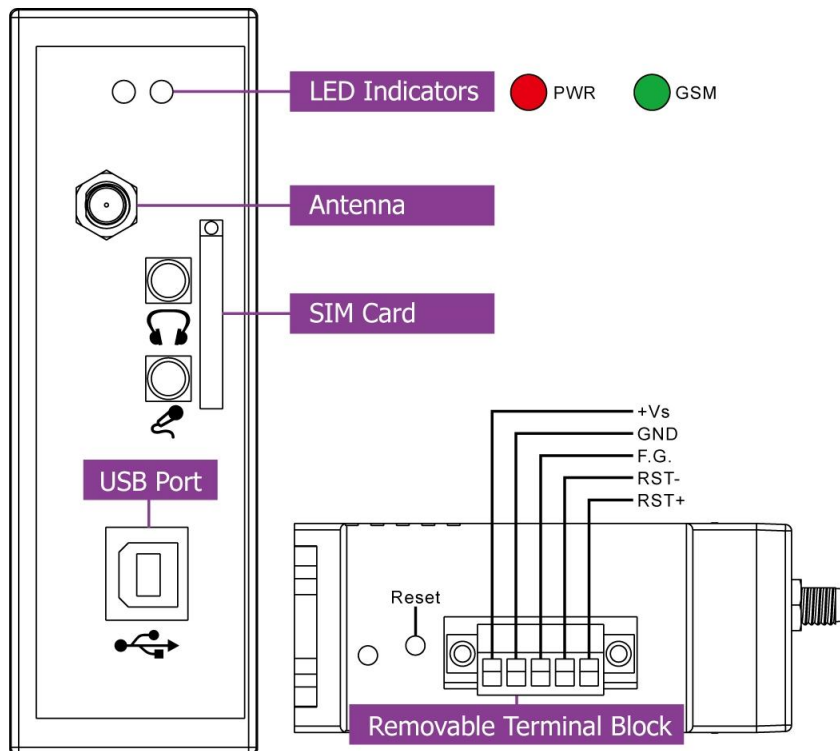

## 4.2 Pin Assignments

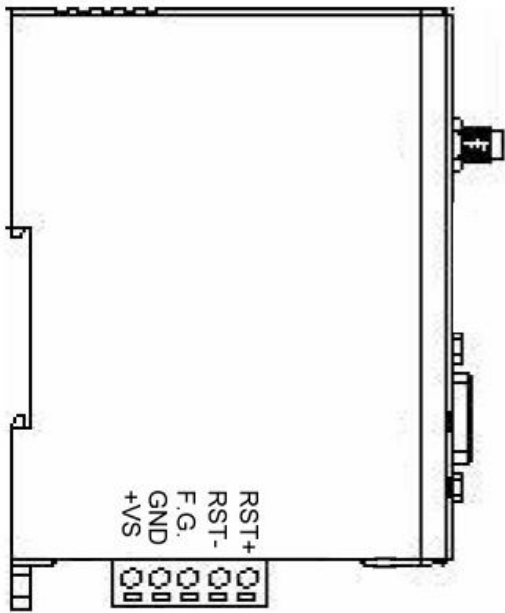

SW1-Operation Mode	
None	No Handshaking
	3-wire RS-232
RTS/CTS	Hardware Handshaking
	9-wire RS-232

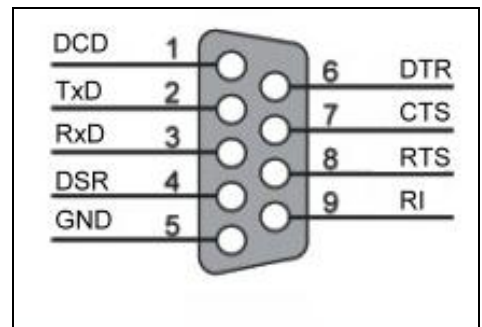

RESET	RST+
	RST-
Frame Ground	F.G.
Power Input: +10 ~ 30V <sub>DC</sub>	DC.GND
	DC.+VS

### 4.3 Hardware Dimensions

➤ **GTM-201-RS232**

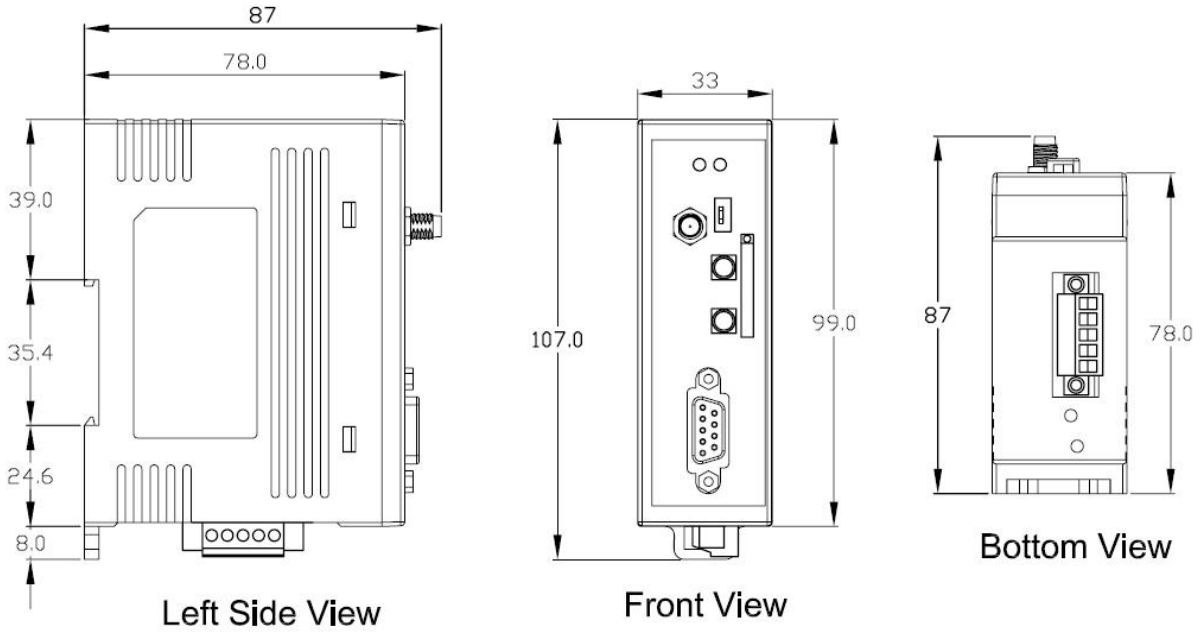

Unit:mm

➤ **GTM-201-USB**

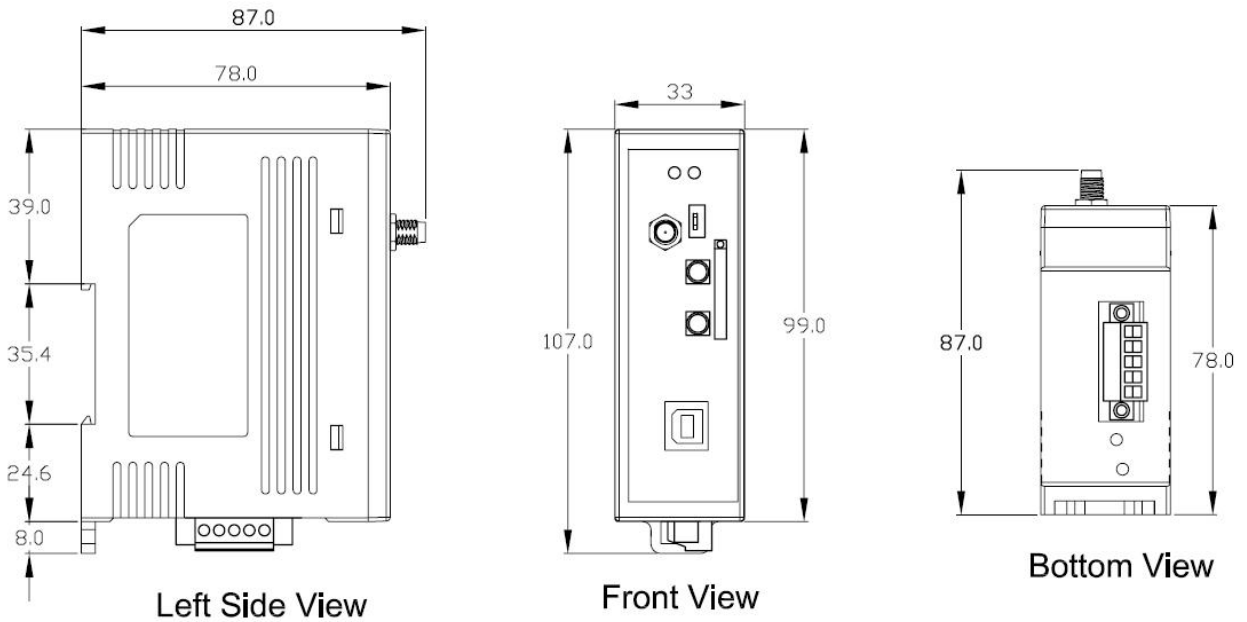

Unit:mm

## 4.4 LED indicators



There are two LED indicators to help users to judge the various conditions of GTM-201. The description is as follows :

**PWR (Red) :** The PWR LED can indicate the status of Power module.

Power normal	Power fail
Always on	Always off

**GSM (Green) :** The modem LED can indicate the status of GSM module.

Modem normal	Modem fail
Blanking (3 sec)	Off or Blanking (not 3 sec)

## Chapter 5 Hardware Wire Connection

### 5.1 Reset Wire Connection

➤ **Reset Wire Connection**

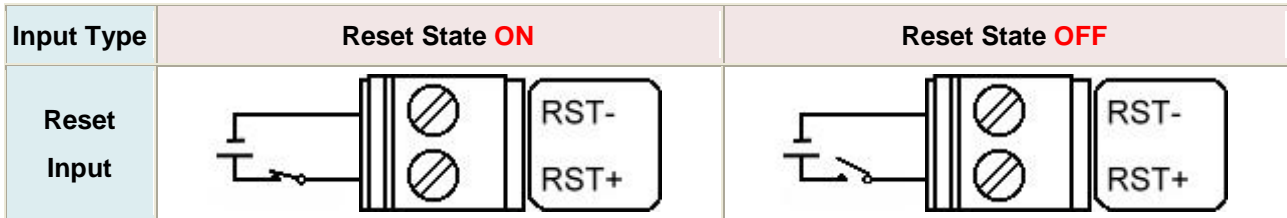

Reset Input	
<b>ON</b> Voltage Level	+3.5 V <sub>DC</sub> ~ +30 V <sub>DC</sub>
<b>OFF</b> Voltage Level	+1 V <sub>DC</sub> max.

➤ **Timing of restart modem**

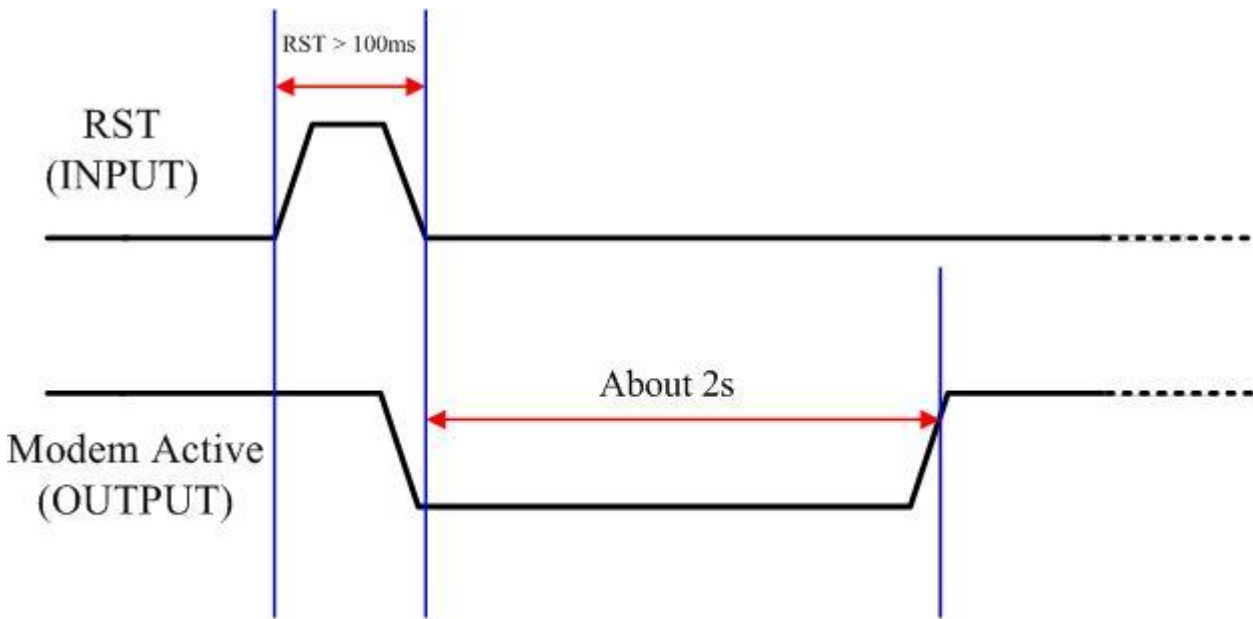

Timing of restart Modem

## 5.2 GSM/GPRS Installation

### ➤ SIM card Installation



### ➤ GPRS/GSM Antenna Installation



### 5.3 Quick Test

➤ Hardware installation :

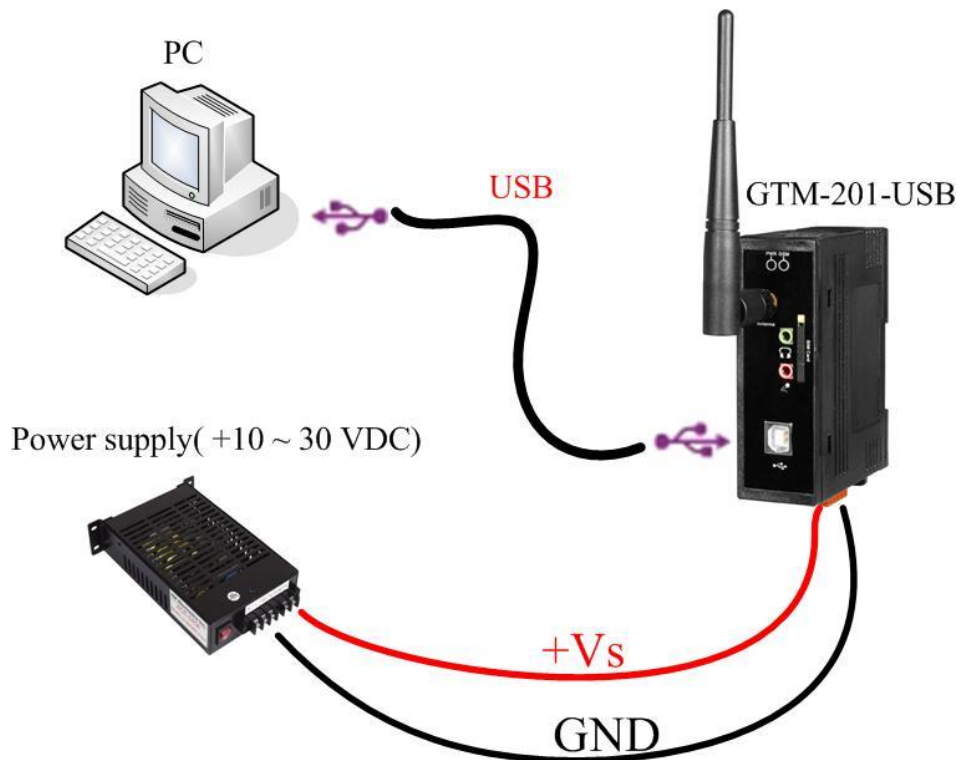
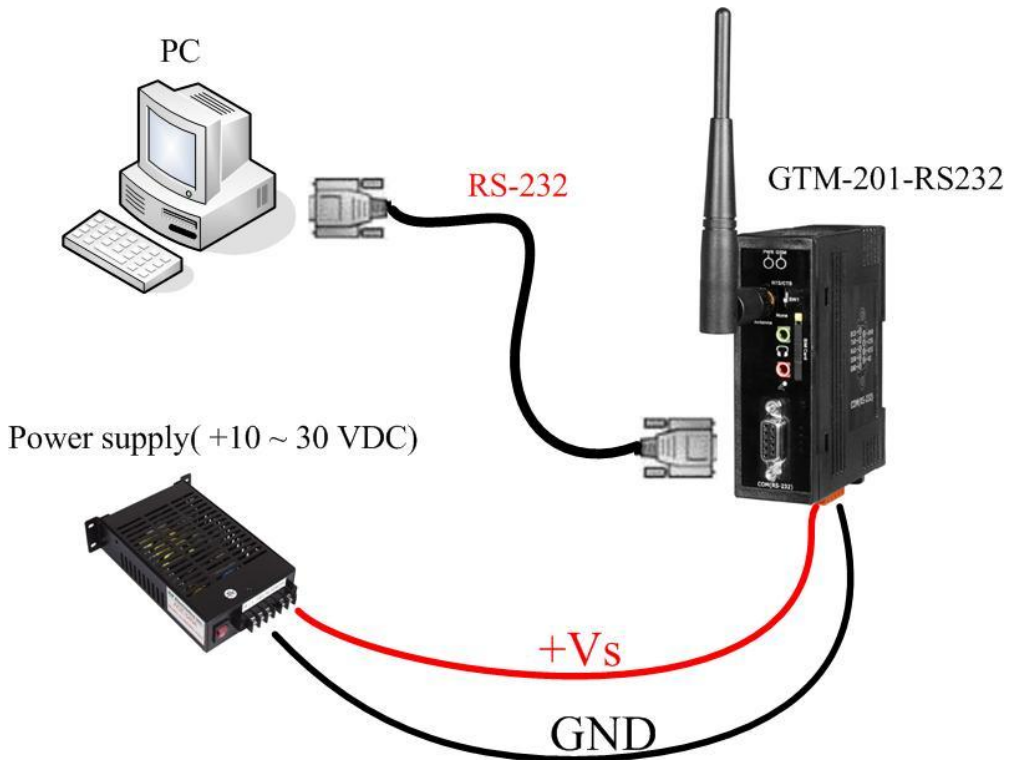

## ➤ Software Installation: (Hyper Terminal)

Step1. Start → All Programs → Accessories → Communications → Hyper Terminal

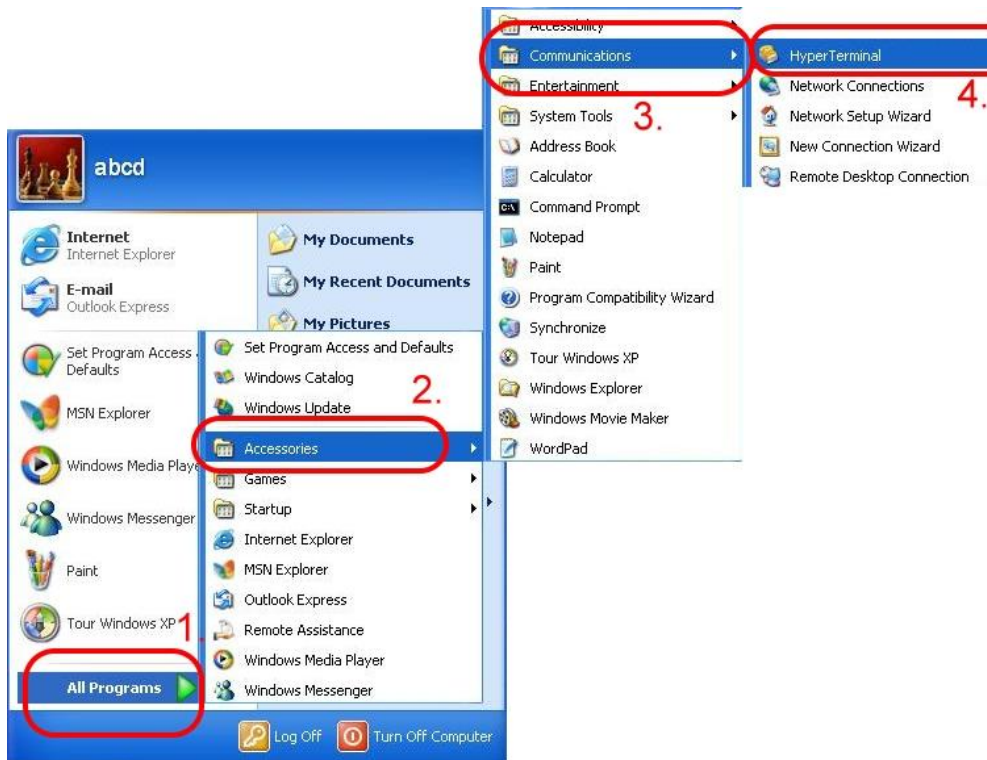

Step2. If these is a pop-up form that “Default Telnet Program?”, please select “Yes”





Step3. Input new connection name → Click “OK”

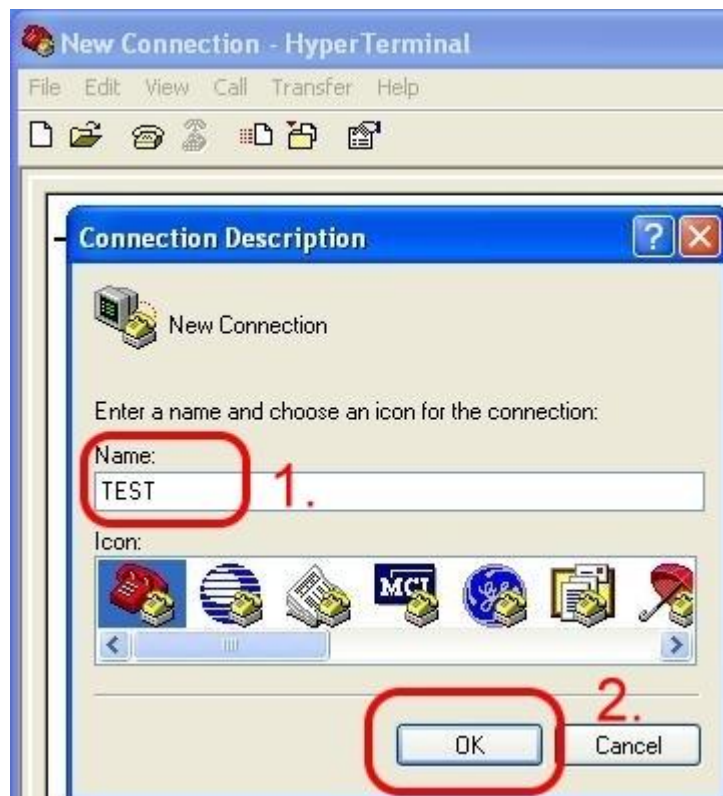

Step4. Select your PC serial port → Click “OK”



Step5. Please refer to the following settings

Bits per second	115200
Data bits	8
Parity	None
Stop bits	1
Flow control	None <b>(Note)</b>

Note: Please select “None” mode on the GTM-201-RS232 **SW1** Hardware

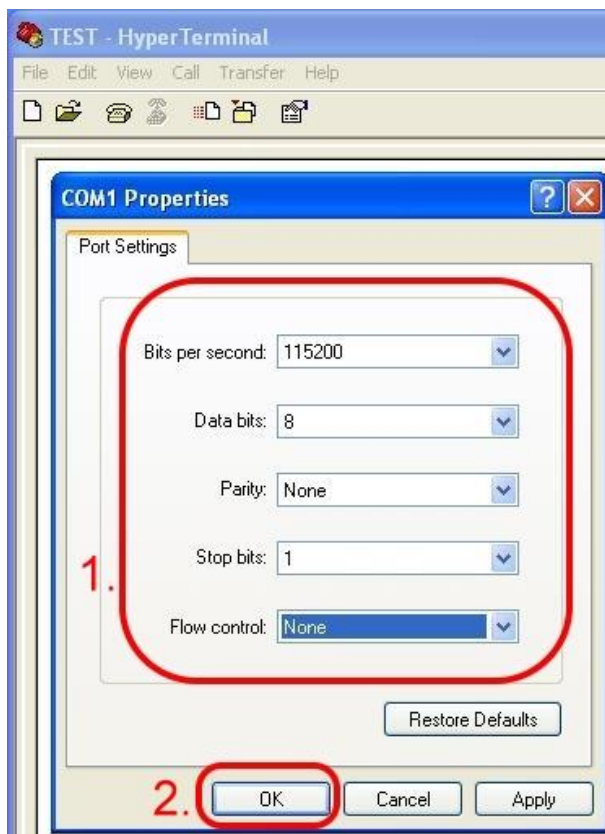

Step6. File → Properties

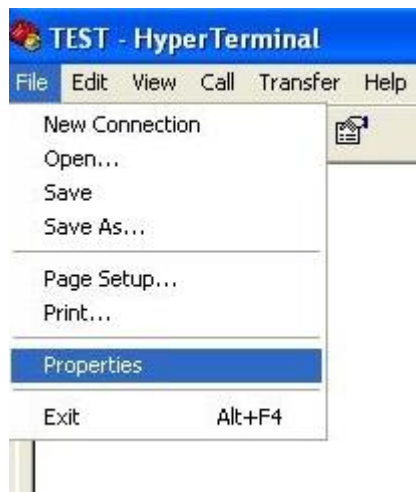

Step7. Settings → Click “ASCII Setup...”

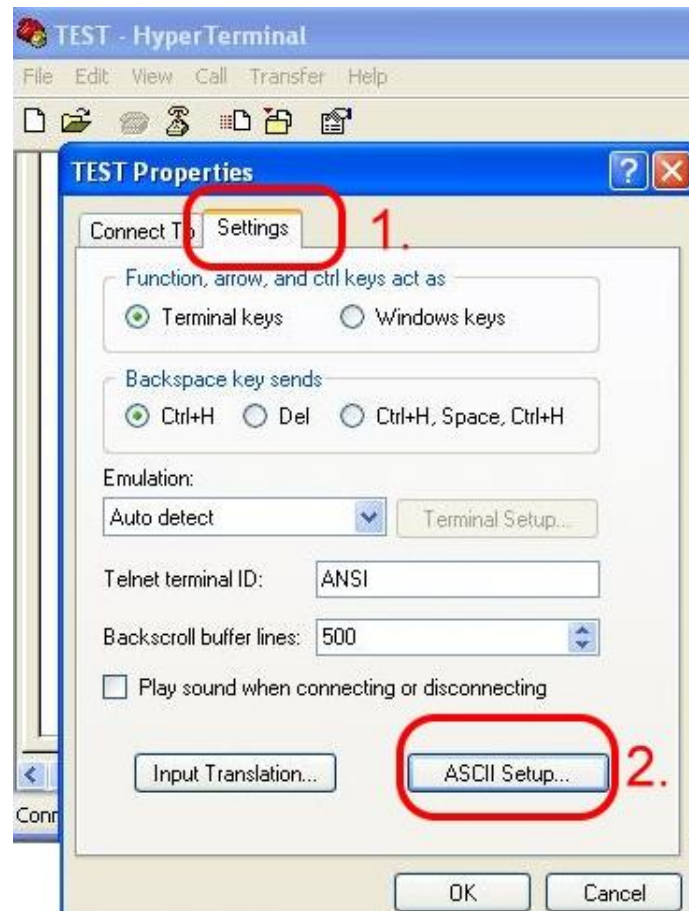

Step8. Select “Echo typed character locally” → OK

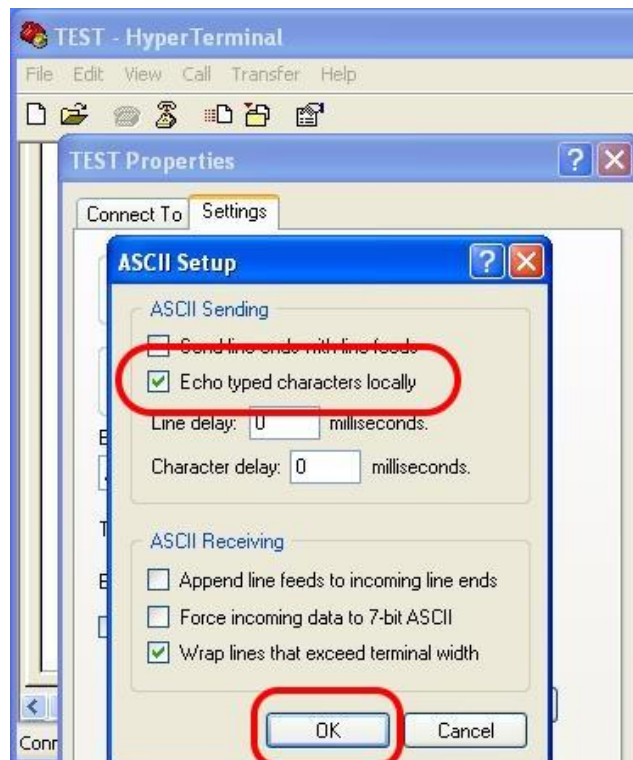

Step9. Input "AT" and press "Enter", then you will receive "AT OK"



## Chapter 6 GPRS connection

### 6.1 XPAC – 8000 (Microsoft Windows XP)

#### 6.1.1.1 GTM-201-RS232 Hardware requirement

- 1) GTM-201-RS232
- 2) XPAC-8000
- 3) RS-232 Cable

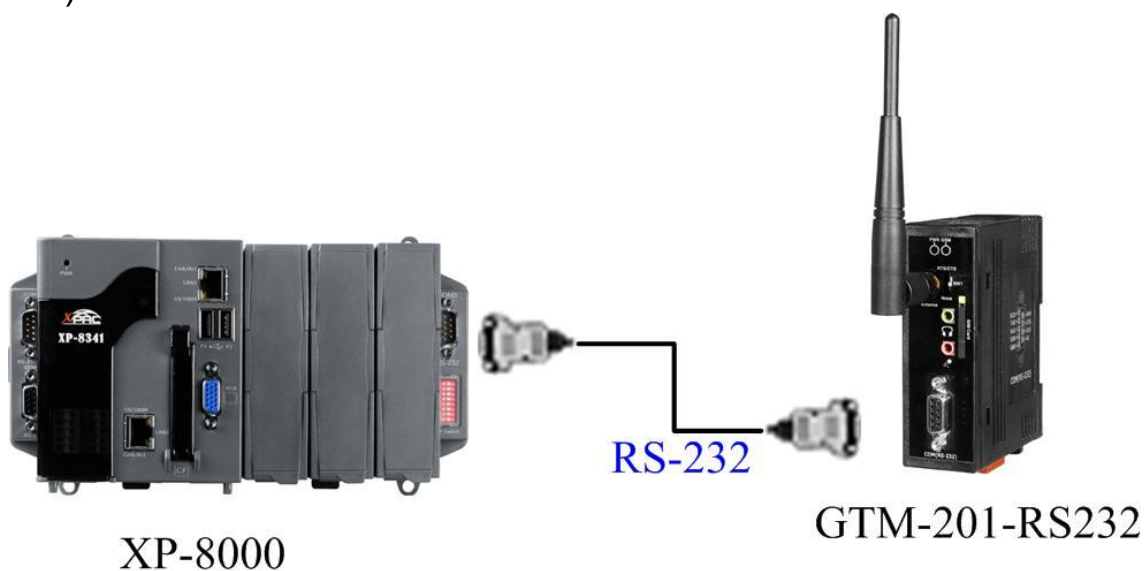

#### 6.1.1.2 GTM-201-USB Hardware requirement

- 1) GTM-201-USB (Please install USB driver first)
- 2) XPAC-8000
- 3) USB Cable

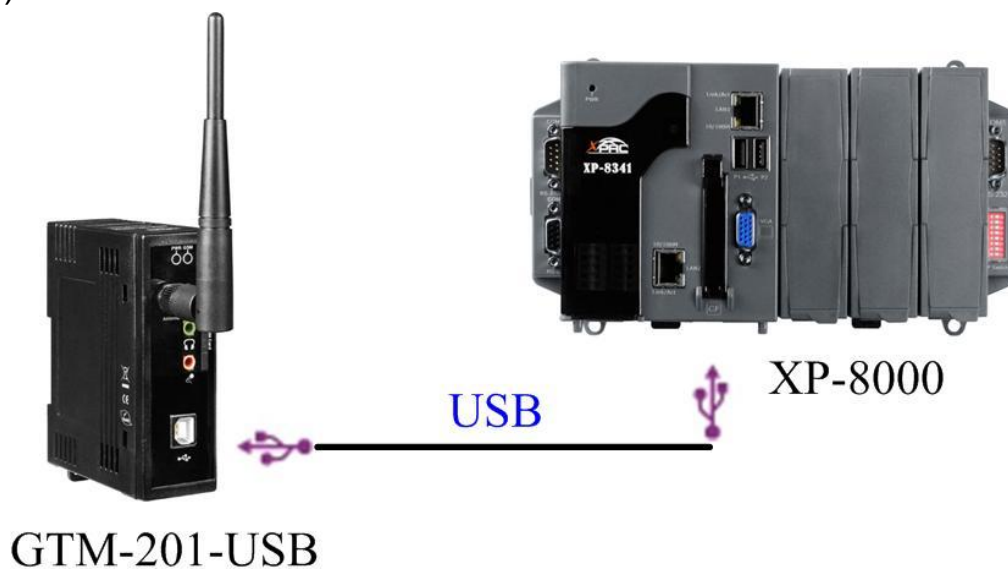

### 6.1.2.1 Create a new modem connection

Step1. Control Panel → Double-click “Phone and Modem Options”

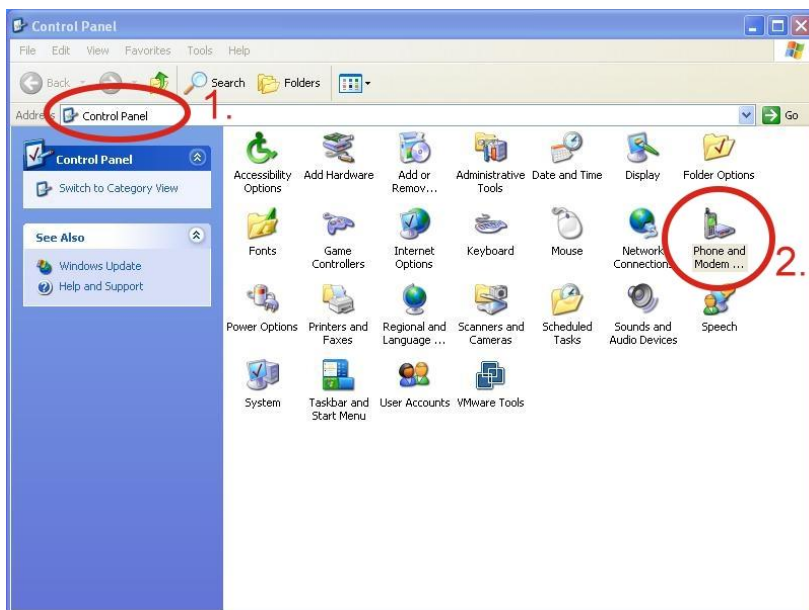

Step2. Set the area code for the first time → Click “OK”

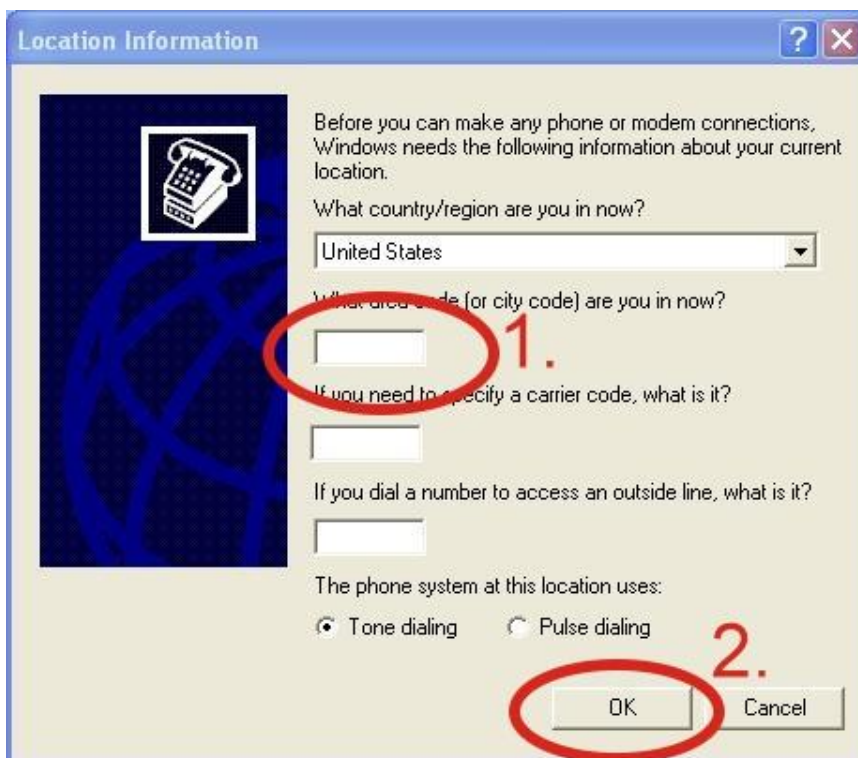

Step3. Control Panel → Double-click “Phone and Modem Options” → Modem → Click “Add”



Step4. Select “Don’t detect my modem; I will select it from a list.” → Click “Next”



Step5. Select "Standard Modem Types" → Select "Standard 19200 bps Modem"  
 → Click "Next"

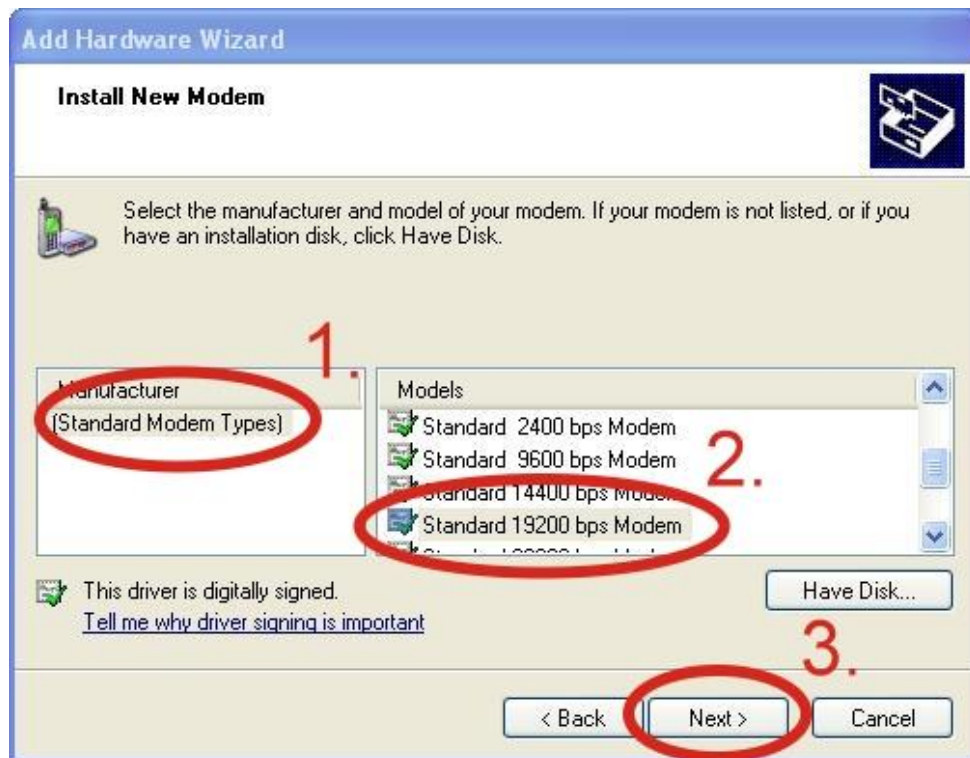

Step6. Select your COM Port to connect to the modem → Click "Next"

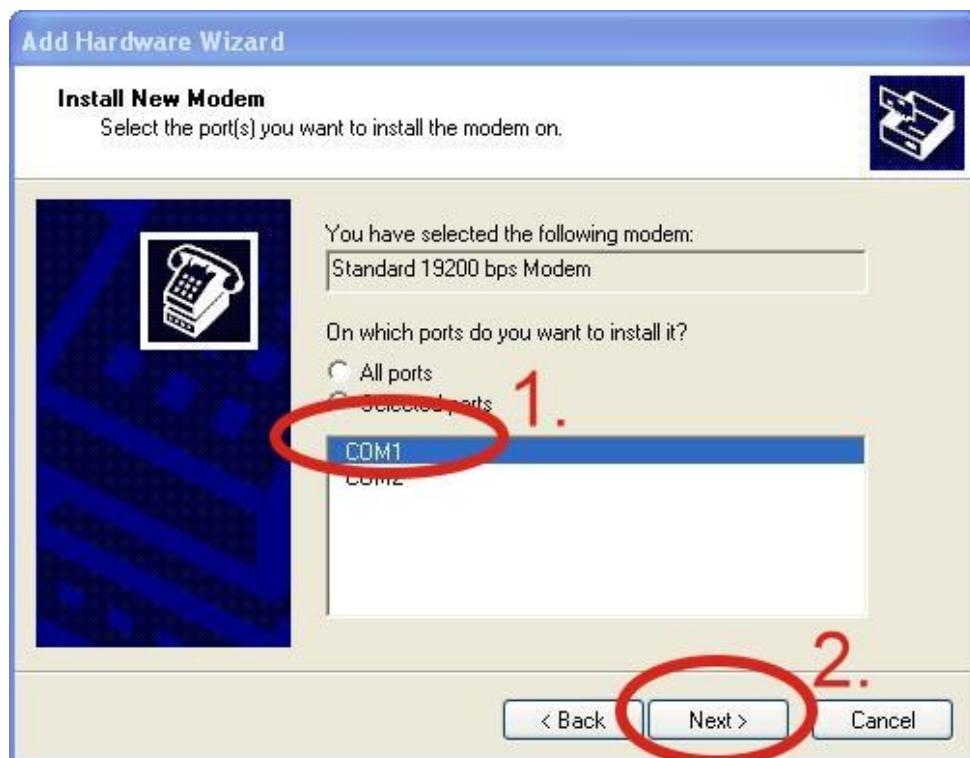



Step7. Click “Finish” to finish the install new modem.



Step8. Control Panel → Double-click “Phone and Modem Options” → Modem → Select “Standard 19200 bps Modem” → Click “Properties”

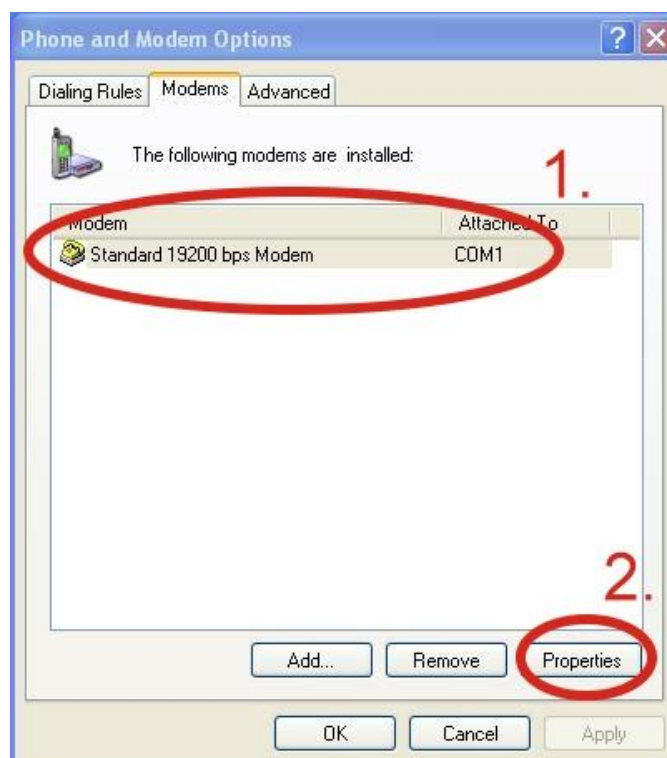

Step9. Control Panel → Double-click “Phone and Modem Options” → Modem →  
Select “Standard 19200 bps Modem” → Click “Properties” → Modem →  
Maximum Port Speed → 115200

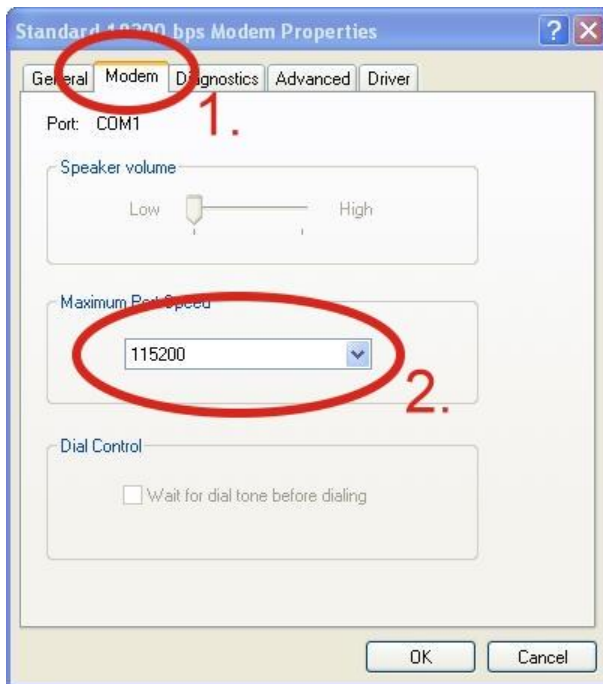

Step10. Advanced → Extra initialization commands:

Note: GPRS's APN must be provided from your Telecom. CO., LTD.

For example in Taiwan: AT+CGDCONT=1,"IP","INTERNET"

For example in China: AT+CGDCONT=1,"IP","CMNET"



Step11. Diagnostics → Query Modem →Click “OK”

Note: If user queries modem that gets a Error, Please try again.

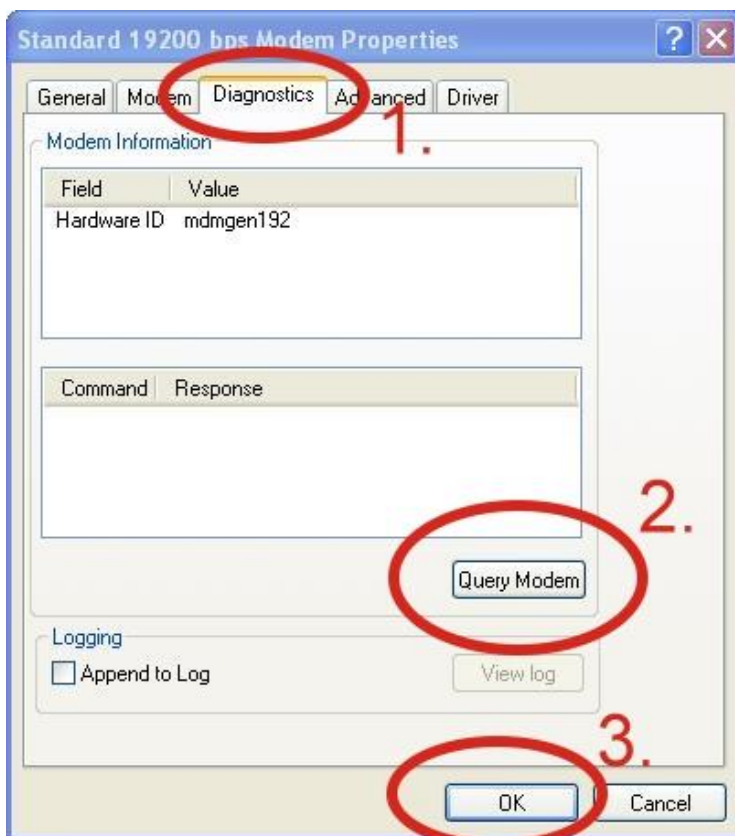

Step12. Click “OK”

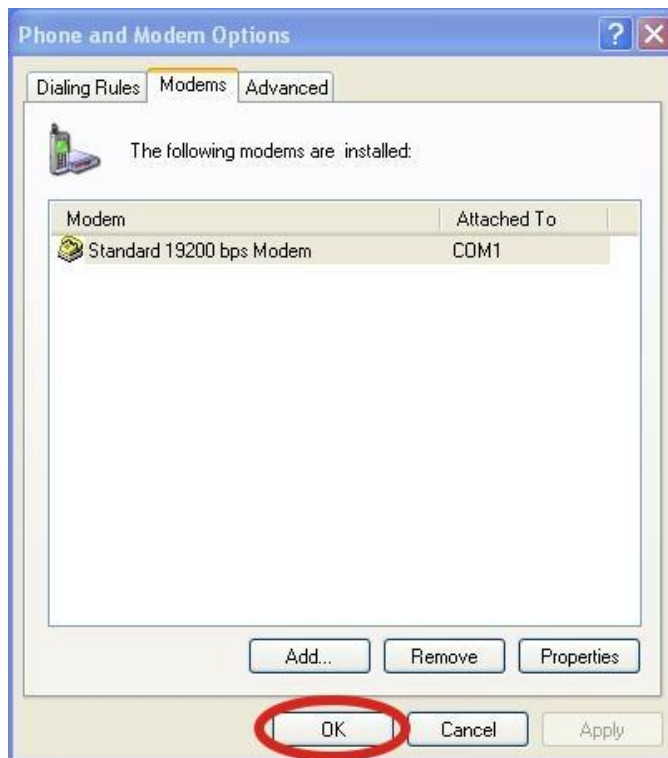

### 6.1.2.2 Create a new dial-up and networking connection

Step1. Control Panel → Network Connections → Click “Create a new connection”

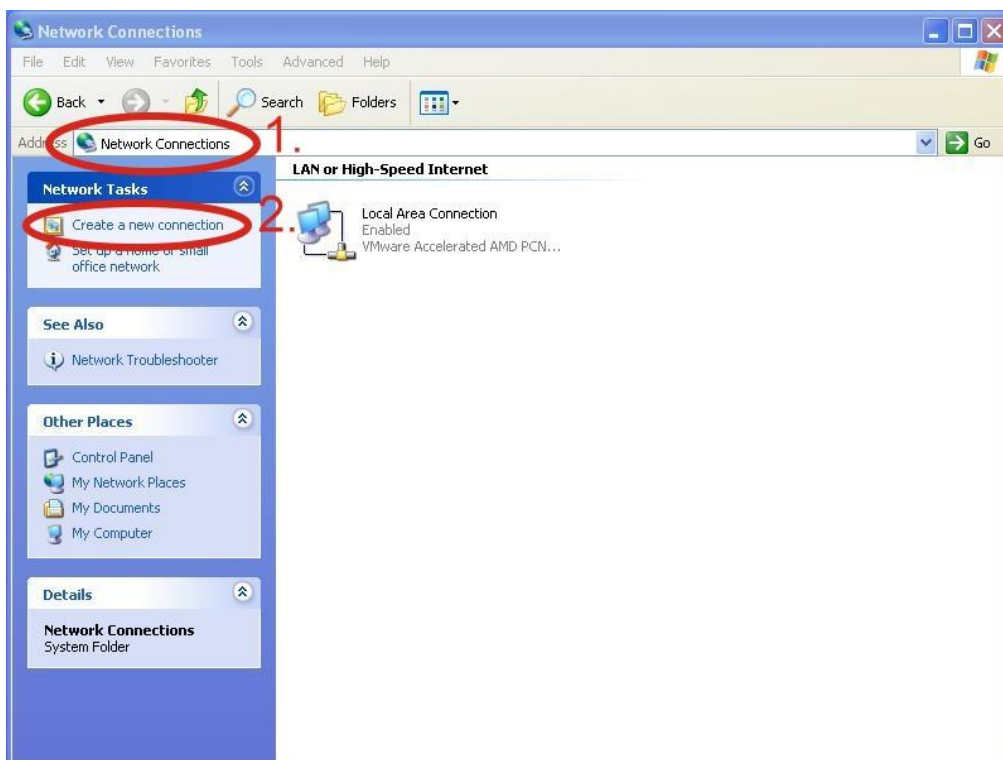

Step2. Click “Next”



Step3. Select "Connect to the Internet" → Click "Next"

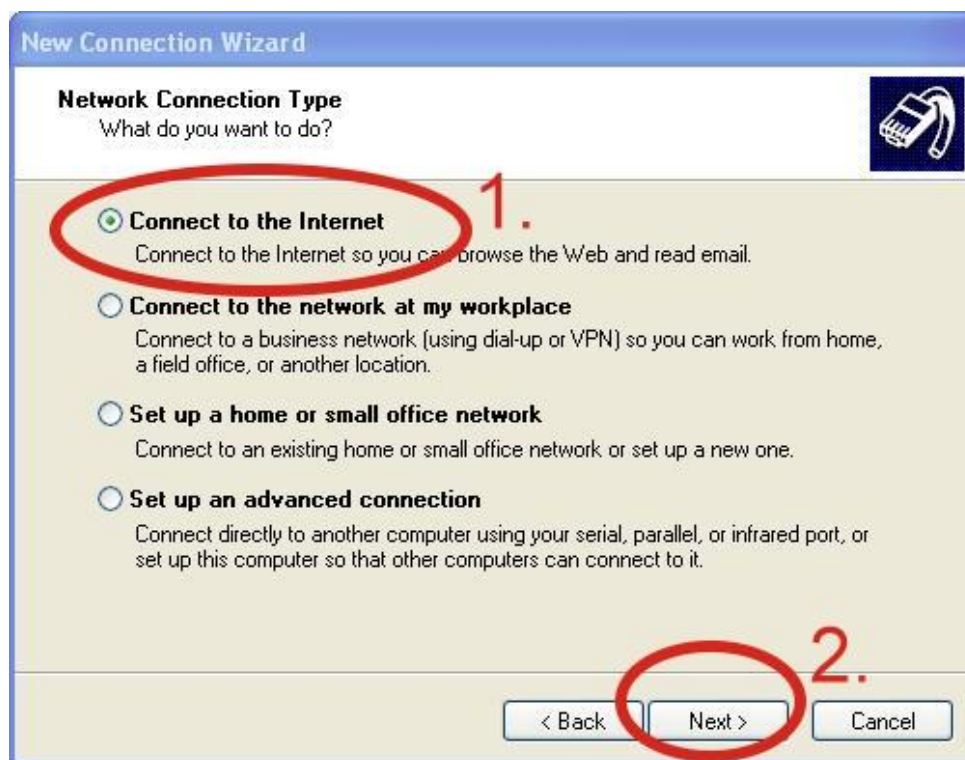

Step4. Select "Connect using a dial-up modem" → Click "Next"

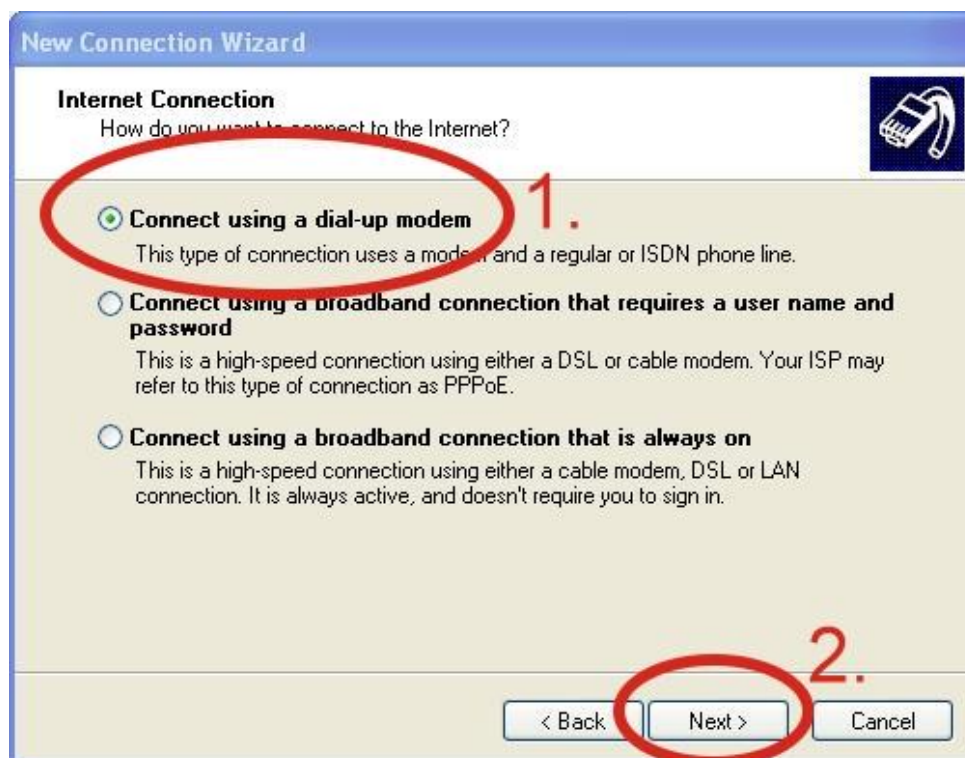

Step5. ISP Name → Your GPRS's name → Click "Next"

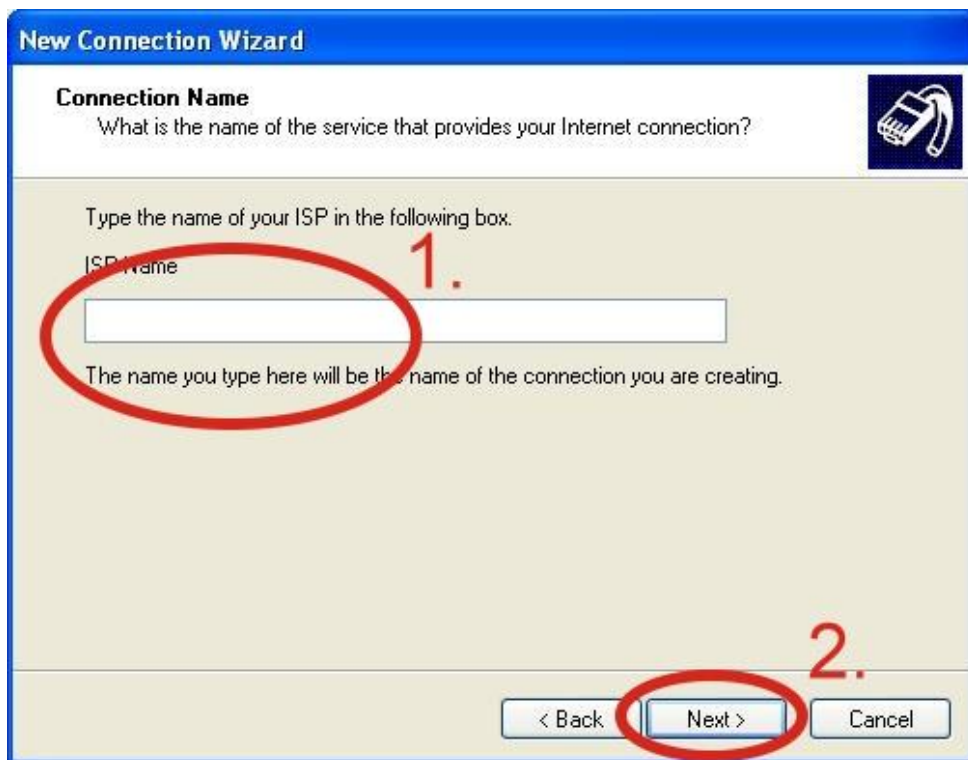

Step6. Phone Number: → Click "Next"

Note: Phone Number must be provided from your Telecom. CO., LTD.

For example in Taiwan: \*99\*\*\*1#



Step7. GPRS's **User name** and GPRS's **Password** → Click "Next"

**Note:** GPRS's **User name** and GPRS's **Password** must be provided from your Telecom. CO., LTD.

**New Connection Wizard**

**Internet Account Information**  
You will need an account name and password to sign in to your Internet account.

Type an ISP account name and password, then write down this information and store it in a safe place. (If you have forgotten an existing account name or password, contact your ISP.)

User name:

Password:

Confirm password:

Use this account name and password when anyone connects to the Internet from this computer.

Make this the default Internet connection.

Turn on Internet Connection Firewall for this connection.

< Back **Next >** Cancel

Step8. Click "Finish"

**New Connection Wizard**

**Completing the New Connection Wizard**

You have successfully completed the steps needed to create the following connection:

**Dial-up Connection**

- Make this the default connection
- This connection is firewalled
- Share with all users of this computer
- Use the same user name & password for everyone

The connection will be saved in the Network Connections folder.

Add a shortcut to this connection to my desktop

To create the connection and close this wizard, click Finish.

< Back **Finish** Cancel

Step9. Control Panel → Network Connections → Click “Your GPRS’s name” → File → Properties

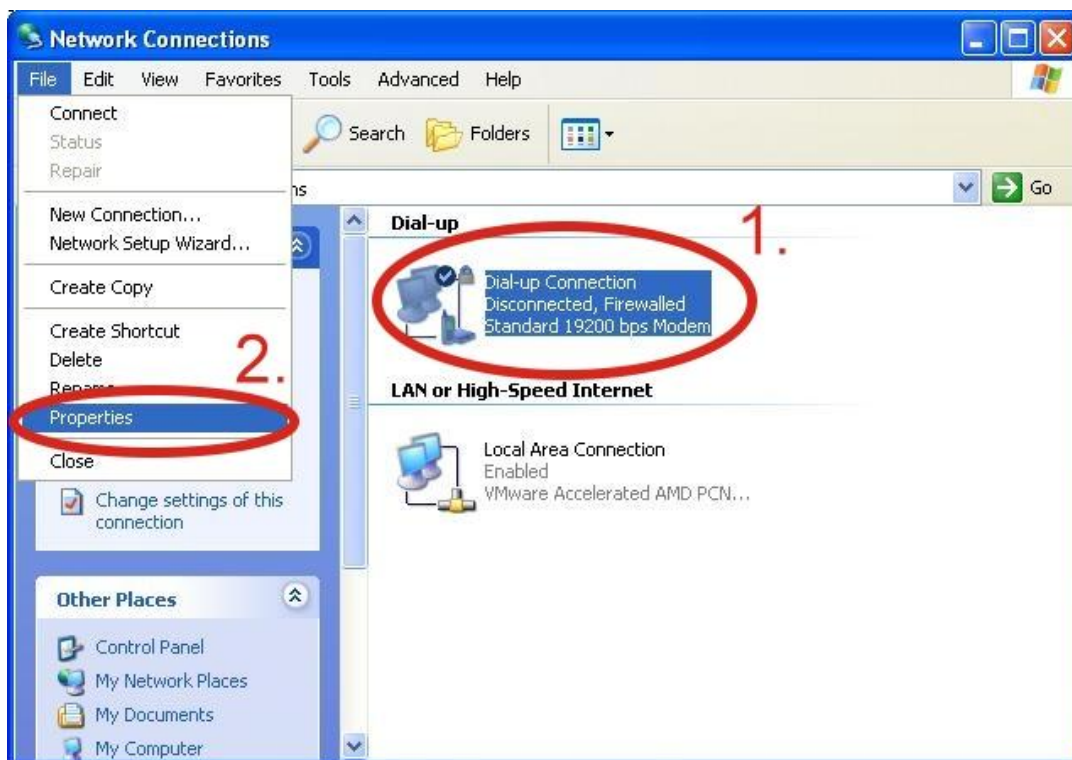

Step10. General → Select “Standard 19200 bps Modem” → Click “Configure”





Step11. Maximum speed(bps) → Select "115200" → "Enable hardware flow control"  
 "(Note) → Click "OK"

**Note1 :** SW 1 on GTM-201-RS232 is "RTS/CTS" mode → Please select "Enable hardware flow control"



**Note2 :** GTM-201-USB → Please don't select "Enable hardware flow control"



Step12. Click “OK”



Step13. Control Panel → Network Connections → Double-Click “Your GPRS’s name”

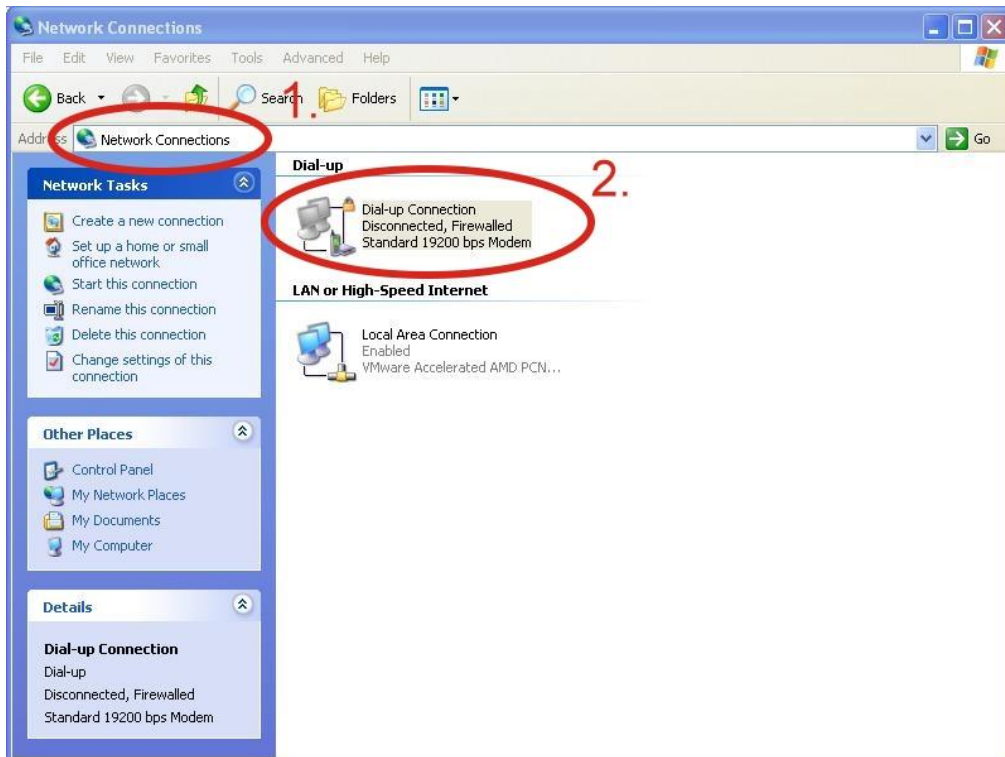

Step14. Click “Dial”



Step15. If you connect to internet successfully, your toolbar have new logo



Step16. You can Double-Click the new logo → Click “Details” → Get your IP address



## 6.2 WinPAC-8000 (WinCE)

### 6.2.1.1 GTM-201-RS232 Hardware requirement

- 1) GTM-201-RS232
- 2) WinPAC-8000
- 3) RS-232 Cable

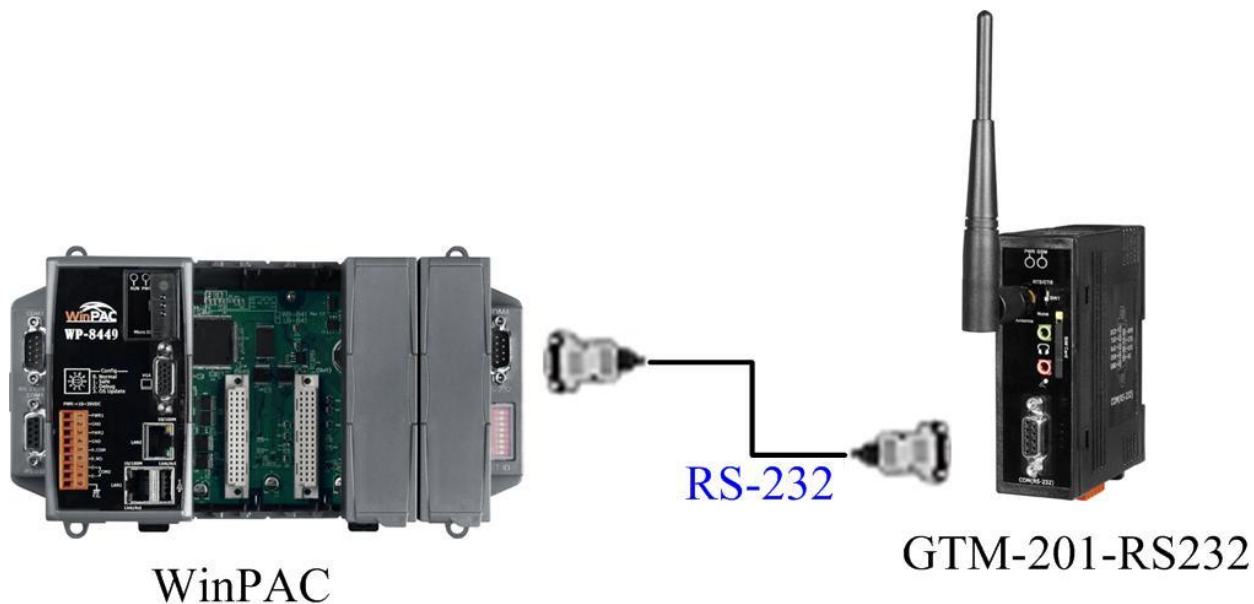

### 6.2.1.2 GTM-201-USB Hardware requirement

- 1) GTM-201-USB (About install USB driver, please refer to the GTM-201-USB\_Install\_driver\_manual. After finishing installing the driver, it will add a com port on WinPAC.)
- 2) WinPAC-8000
- 3) USB Cable

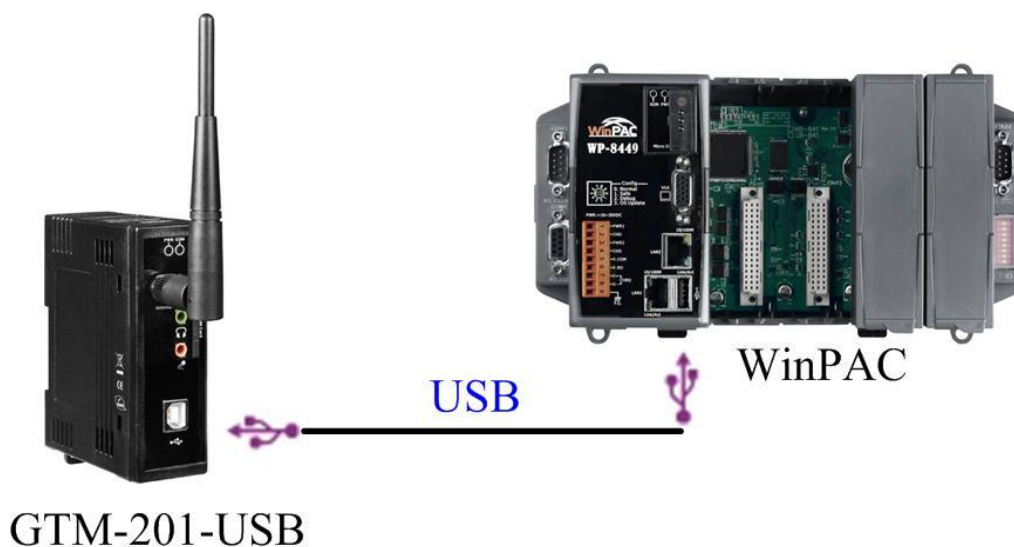

### 6.2.2.1 Create a new modem connection

- Step1. Copy "ICPDAS GTM-201-RS232\_COM4\_winpac.cab" to your WinPAC →
- Double-Click "ICPDAS GTM-201-RS232\_COM4\_winpac.cab" to install →
- Select "OK"

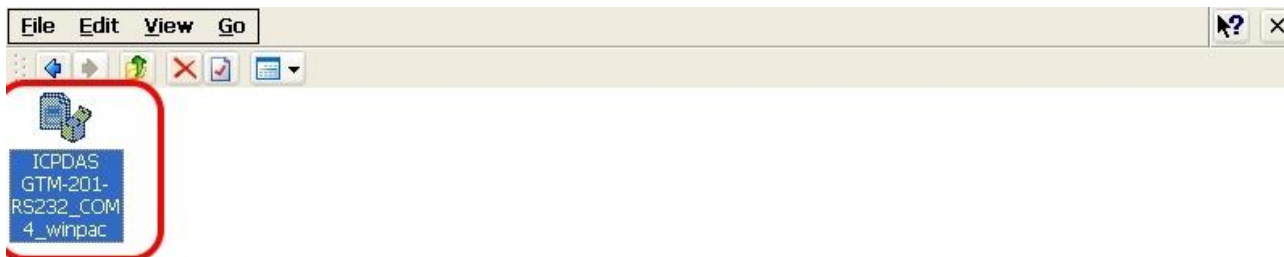

- Step2. Execute "WinPAC\_Utility" → File → Save and Reboot

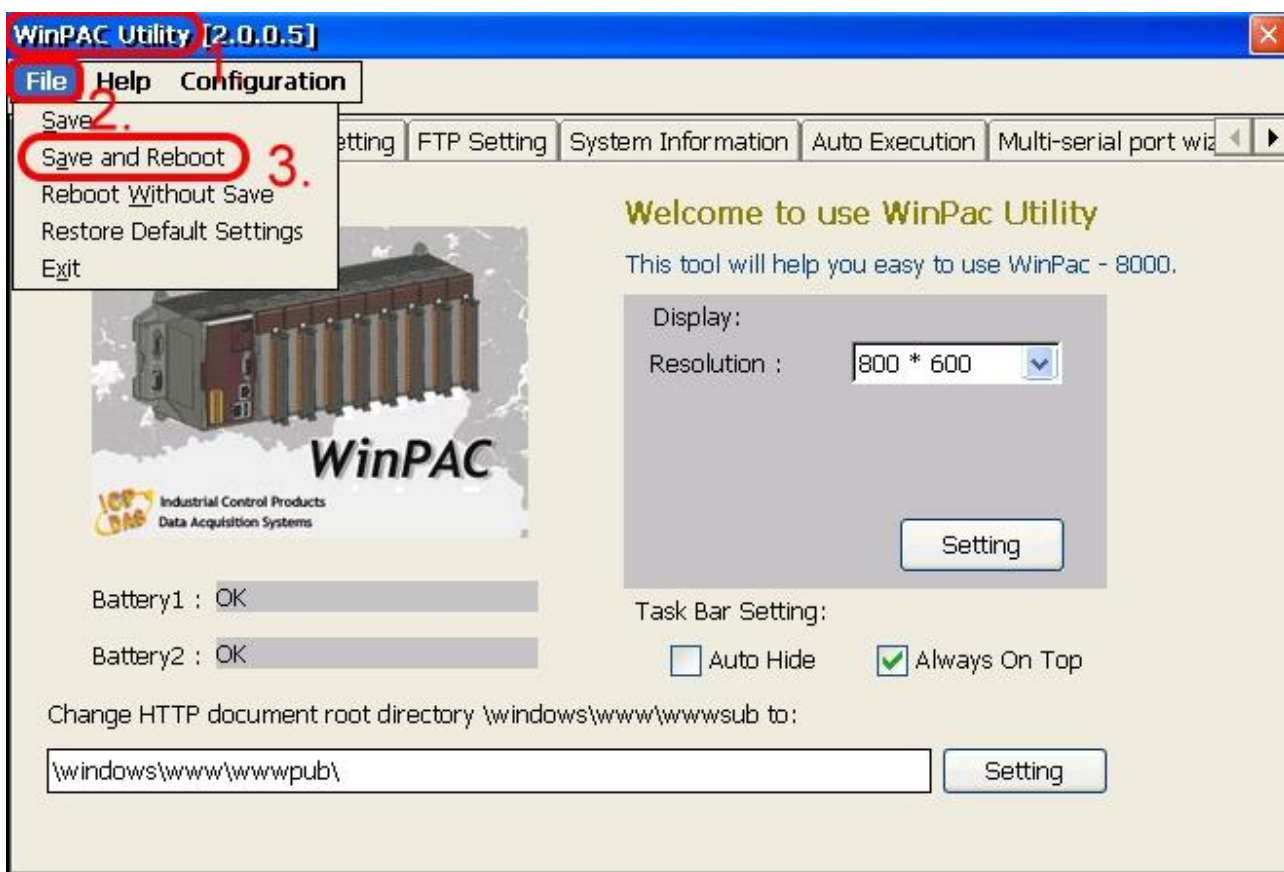

### 6.2.2.2 Create a new dial-up and newworking connection

Step1. Control Panel → Double-Click "Network and Dial-up Connections"

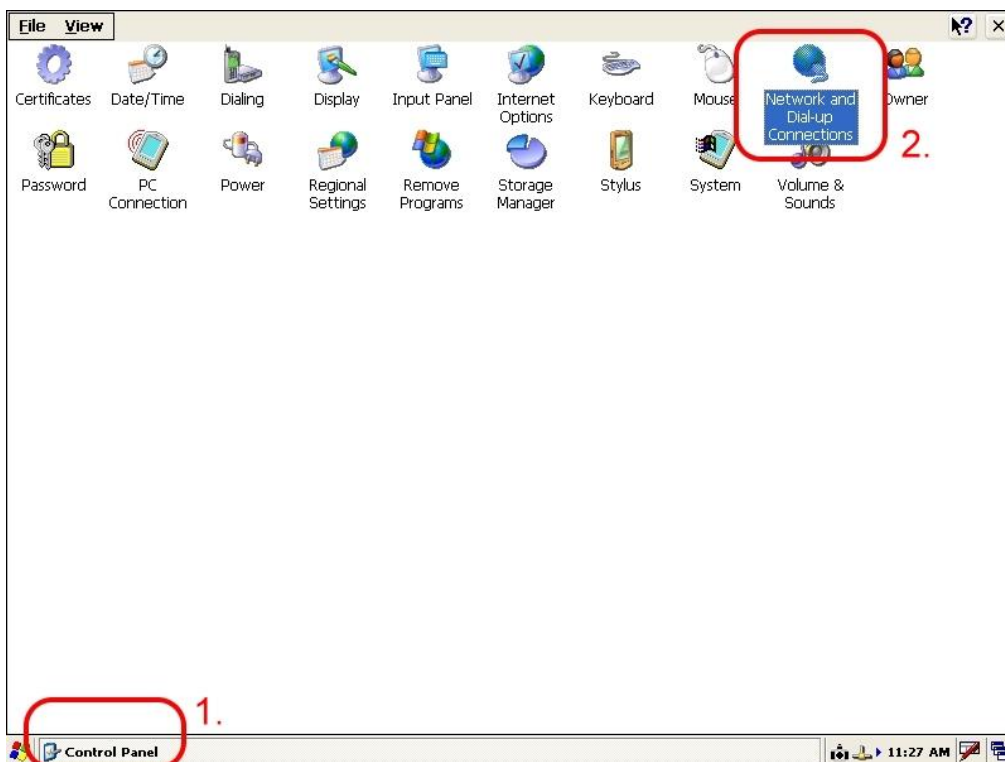

Step2. Double-Click "Make New Connection"

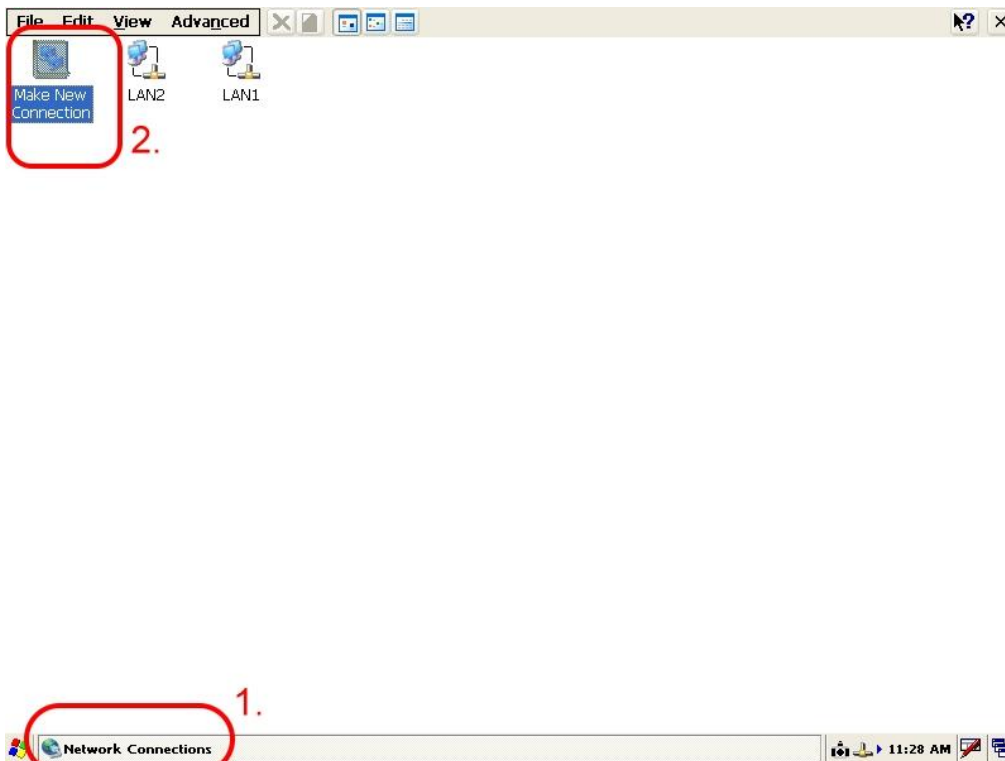

Step3. Keyin your name for the connection → Select “Dial-Up Connection” →  
Click “Next”



Step4. Select “ICPDAS GTM-201-RS232 COM4:” → Click “Configure...”

Note: If your device is GTM-201-USB, please select “ICPDAS GTM-201-USB COM5:”



Step5. Select Baud Rate "115200", Data Bits "8", Parity "None", Stop Bits "1" Note → Click "Call Options"

Note:

GTM-201-RS232 "RTS/CTS" mode	Please select "Hardware"
GTM-201-RS232 "None" mode	Please select "None"
GTM-201-USB	Please select "None"



Step6. Extra Settings → Click "OK"

Note: GPRS's APN must be provided from your Telecom. CO., LTD.

For example in Taiwan: +CGDCONT=1,"IP","INTERNET"

For example in China: +CGDCONT=1,"IP","CMNET"

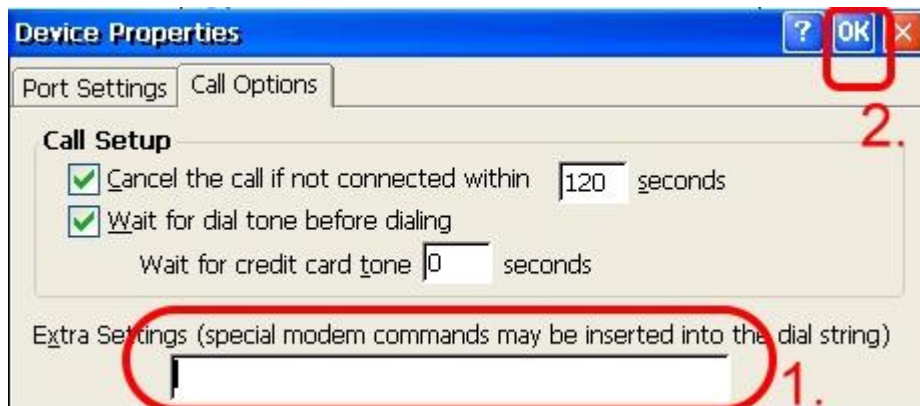



Step7. Click “TCP/IP Settings...”



Step8. TCP/IP Settings: Dependant on the requirement of each ISP.



Step9. Click “Security Settings...”



Step10. Security Settings: Dependant on the requirement of ISP ! ( Below picture is the setting for HINET ) .



Step11. Click “Next”

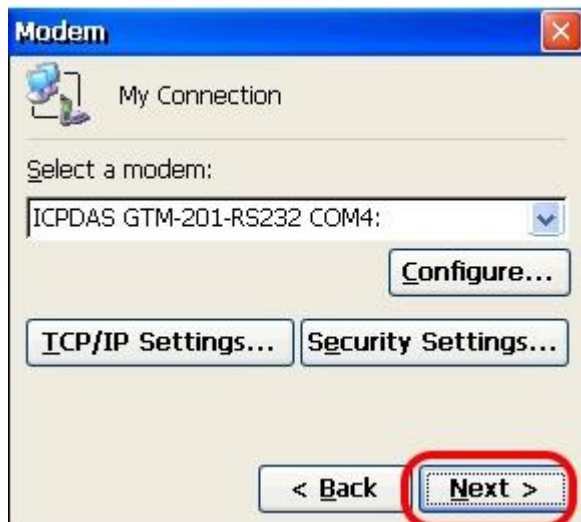

Step12. Phone Number: → Click “Finish”

Note: Phone Number must be provided from your Telecom. CO., LTD.

For example in Taiwan: \*99\*\*\*1#



Step13. Double-Click you make new connection name

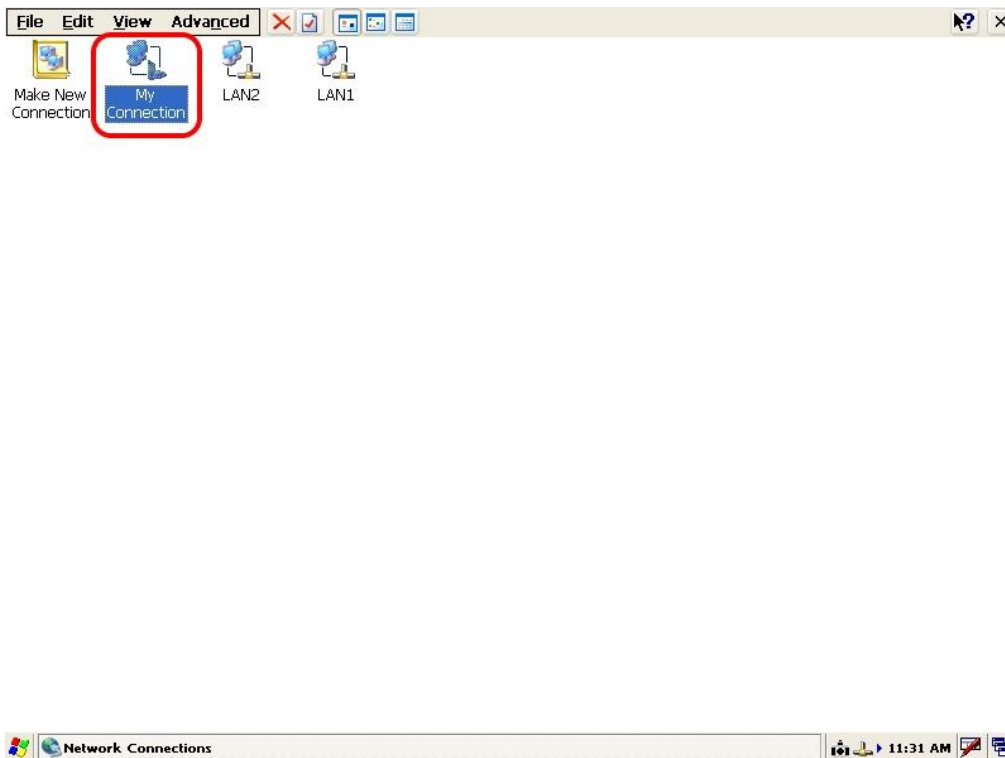

Step14. Click "Dial Properties..."



Step15. Click “Dialing Patterns...”

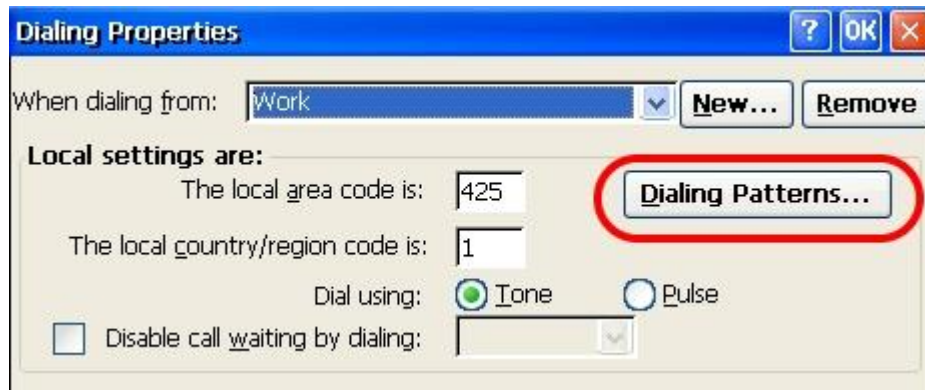

Step16. Keyin ‘G’ to all blocks → Click “OK”

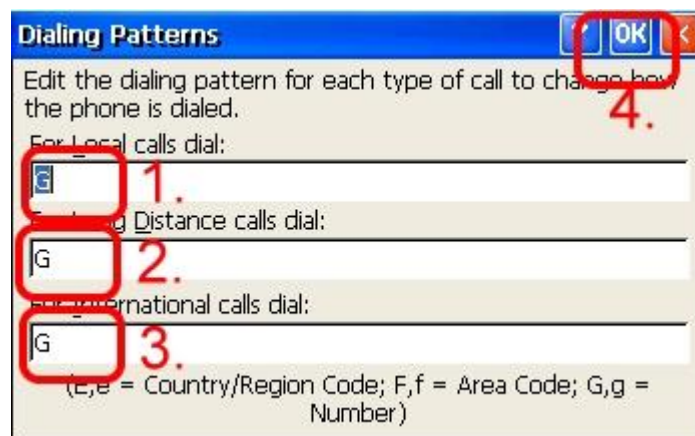

Step17. GPRS's **User name** and GPRS's **Password** → Click “Connect”

**Note:** GPRS's **User name** and GPRS's **Password** must be provided from your Telecom. CO., LTD.



Step18. If you connect to internet successfully, they will show “**Connected**”



Step19. Execute “WinPAC\_UTILITY” → File → Save and Reboot

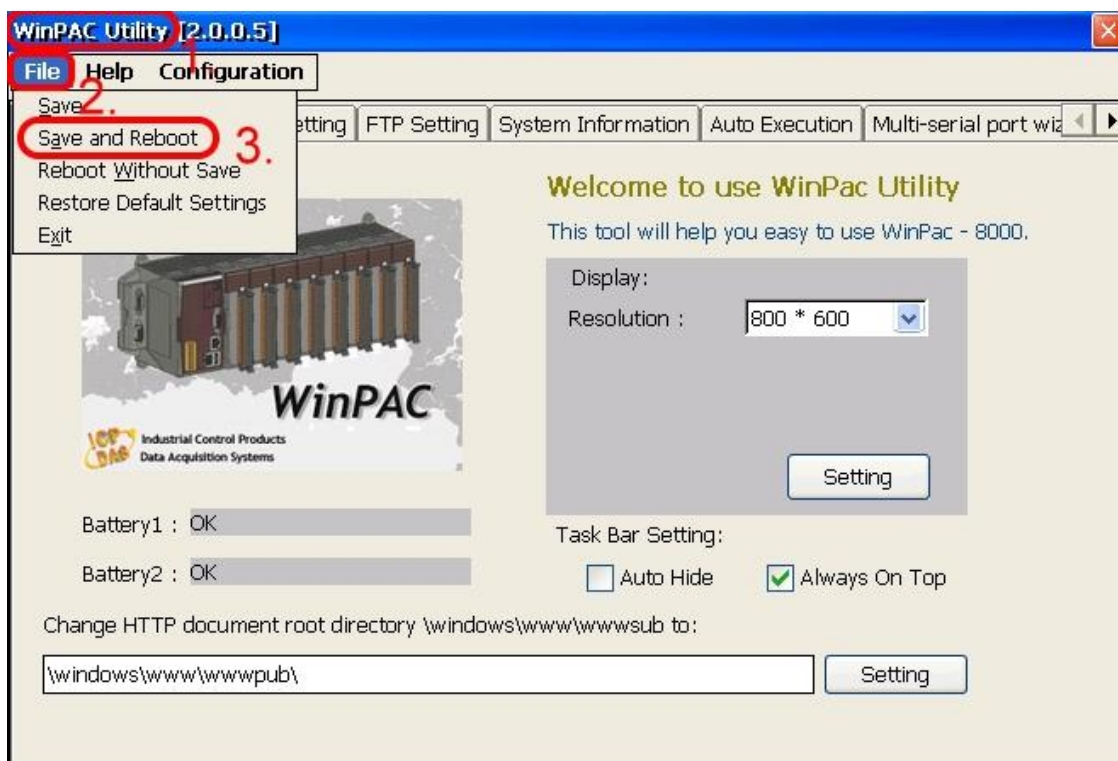

## 6.3 LinPAC – 8000 (Linux)

### 6.3.1.1 GTM-201-RS232 Hardware requirement

- 1) GTM-201-RS232
- 2) LinPAC-8000
- 3) RS-232 Cable

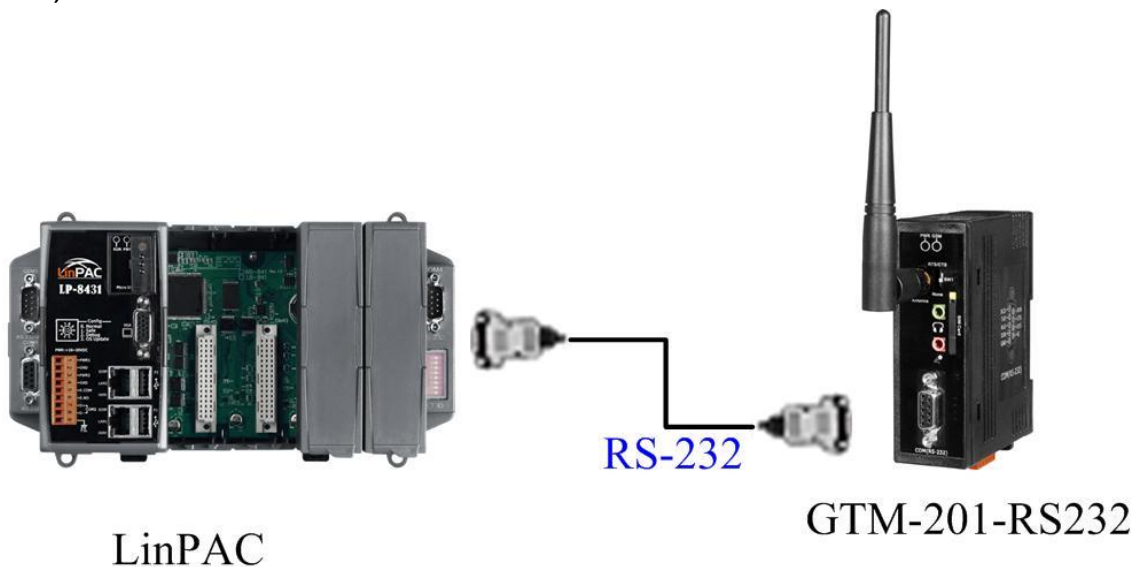

### 6.3.1.2 GTM-201-USB Hardware requirement

- 1) GTM-201-USB (Please install USB driver first)
- 2) LinPAC-8000
- 3) USB Cable

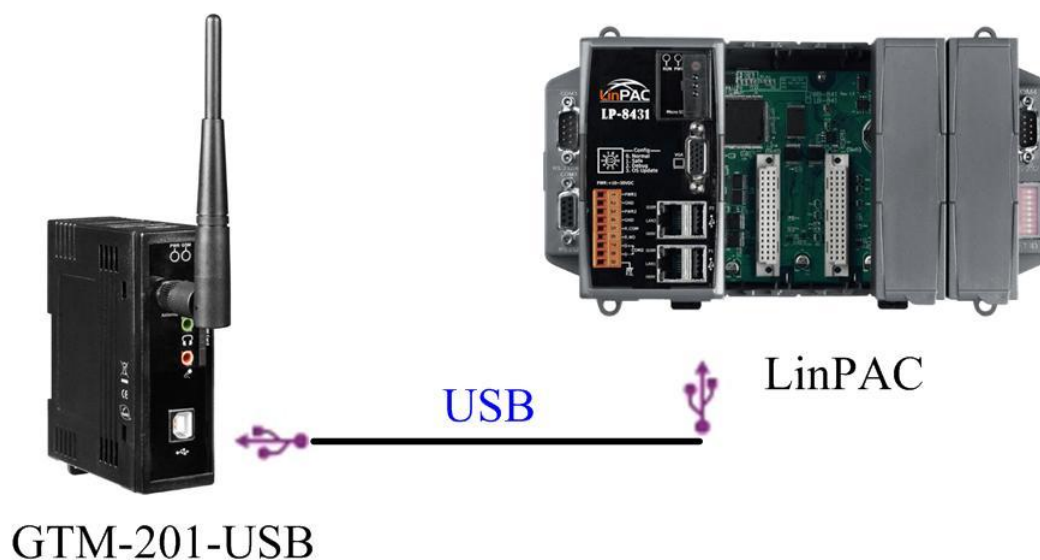

### 6.3.2.1 GTM-201-RS232

If users want to connect the gprs modem to the **COM4** of LinPAC-8000, users should modify **/etc/ppp/peers/wavecom** to define COM port first. Please follow the steps as below :

(1) Type “ **vi /etc/ppp/peers/wavecom** ”

(2) To find the “Serial device to which the GPRS phone is connected:” statement, and add device name of COM port.

Modify “**/etc/ppp/peers/wavecom**”

.....  
 .....

# Serial device to which the GPRS phone is connected:  
 # /dev/ttyS0 for serial port (COM1 in Windows),  
 # /dev/ircomm0 for IrDA,  
 # /dev/ttyUB0 for Bluetooth (Bluez with rfcmm running) and  
 # /dev/ttyUSB0 #for USB

**/dev/ttyS34 # serial port one**

# /dev/ttyS0 # serial port one

# /dev/ttyS1 # serial port two

.....  
 .....

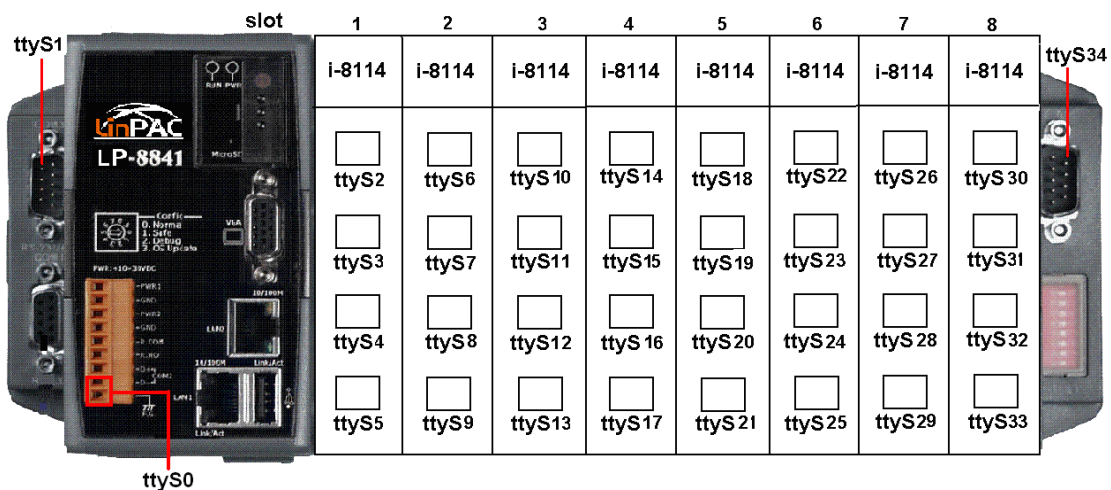

```
# Serial device to which the GPRS phone is connected:
# /dev/ttyS0 for serial port (COM1 in Windows),
# /dev/ircomm0 for IrDA,
# /dev/ttyUB0 for Bluetooth (Bluez with rfcmm running) and
# /dev/ttyUSB0 #for USB
/dev/ttyS34 # serial port one → Connect the GPRS to the COM4
#/dev/ttyS0 # serial port one
#/dev/ttyS1 # serial port two
#/dev/ircomm0 # IrDA serial port one
#/dev/rfcomm0 # Bluetooth serial port one
#/dev/ttyUSB0 # USB serial device, for example Orange SPV
```



(3) Type “ :wq ” to save and quit the script.

The default GPRS baudrate is “ 115200 ” in the LinPAC, so if users finish the setting of gprs modem and connect the gprs modem to the COM port of LinPAC-8000, just type in “ **pppd call wavecom** ” and then LinPAC-8000 will be connected to the internet automatically. Remember that the network interface card of LinPAC should stop first, just type in “ **ifdown eth0** ” to stop it. If users type in “ **ifconfig** ” will see the “ **ppp0** ” option.

### 6.3.2.2 GTM-201-USB

If users want to connect the gprs modem to the USB of LinPAC-8000, users should modify [/etc/ppp/peers/wavecom](#) to define USB first. Please follow the steps as below :

(1) Type “ **vi /etc/ppp/peers/wavecom** ”

(2) To find the “Serial device to which the GPRS phone is connected:” statement, and add device name of USB.

Modify “[/etc/ppp/peers/wavecom](#)”

.....  
.....

```
# Serial device to which the GPRS phone is connected:
# /dev/ttyS0 for serial port (COM1 in Windows),
# /dev/ircomm0 for IrDA,
# /dev/ttyUB0 for Bluetooth (Bluez with rfcomm running) and
/dev/ttyUSB0 #for USB
```

```
#/dev/ttyS34 # serial port one
# /dev/ttyS0 # serial port one
# /dev/ttyS1 # serial port two
.....
.....
```

(3) Type “ :wq ” to save and quit the script.



```
# Serial device to which the GPRS phone is connected:
# /dev/ttyS0 for serial port (COM1 in Windows),
# /dev/ircomm0 for IrDA,
# /dev/ttyUB0 for Bluetooth (Bluez with rfcomm running) and
/dev/ttyUSB0 #for USB → Connect the GPRS to the USB
#/dev/ttyS34 # serial port one
#/dev/ttyS0 # serial port one
#/dev/ttyS1 # serial port two
#/dev/ircomm0 # IrDA serial port one
#/dev/rfcomm0 # Bluetooth serial port one
#/dev/ttyUSB0 # USB serial device, for example Orange SPV
```

The default GPRS baudrate is “ 115200 ” in the LinPAC, so if users finish the setting

of gprs modem and connect the gprs modem to the USB of LinPAC-8000, just type in “ **pppd call wavecom** ” and then LinPAC-8000 will be connected to the internet automatically. Remember that the network interface card of LinPAC should stop first, just type in “ **ifdown eth0** ” to stop it. If users type in “ **ifconfig** ” will see the “ **ppp0** ” option.

**Remark: Please check O.S version. We have supported the GTM-201-USB module after O.S version 1.2.**

## Chapter 7 USB driver installation

### 7.1 XPAC – 8000 (Microsoft Windows XP)

#### 7.1.1 Automatically install usb driver

Step1. Connect the GTM-201-USB and XPAC hardware with the USB cable, then power on.

Step2. If pop up a new window that “Found New Hardware Wizard”, please select “Cancel”



Step3. Double-click GTM-201-USB driver that “GTM-201-USB\_v1.xx.exe”.

Step4. Select "Next"

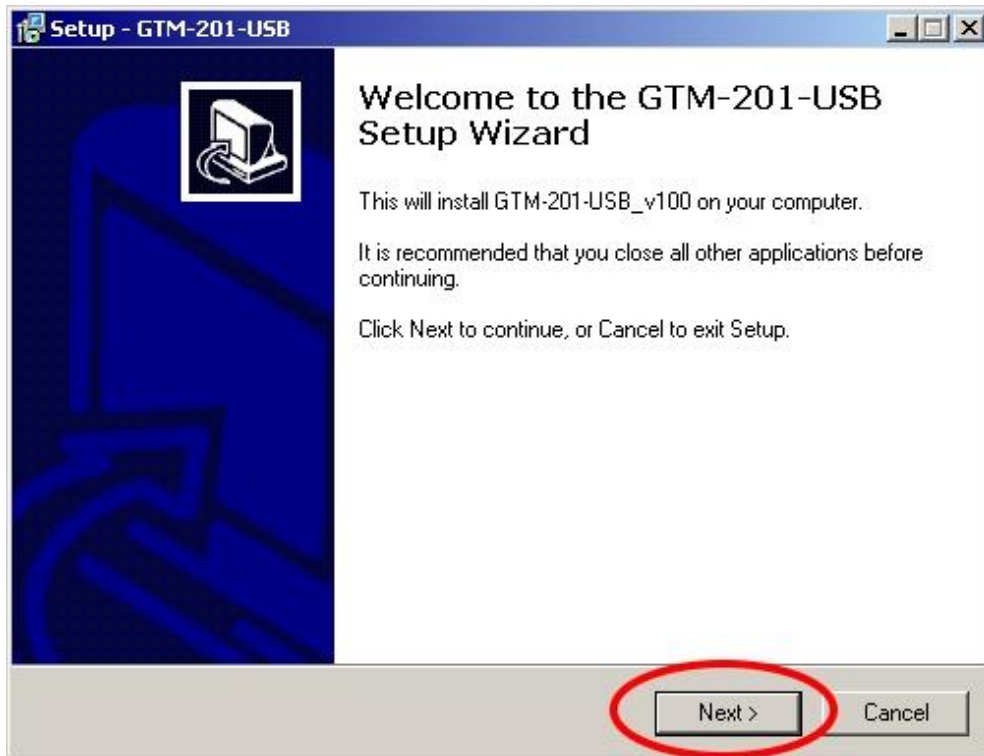

Step5. Select install folder → Select "Next"

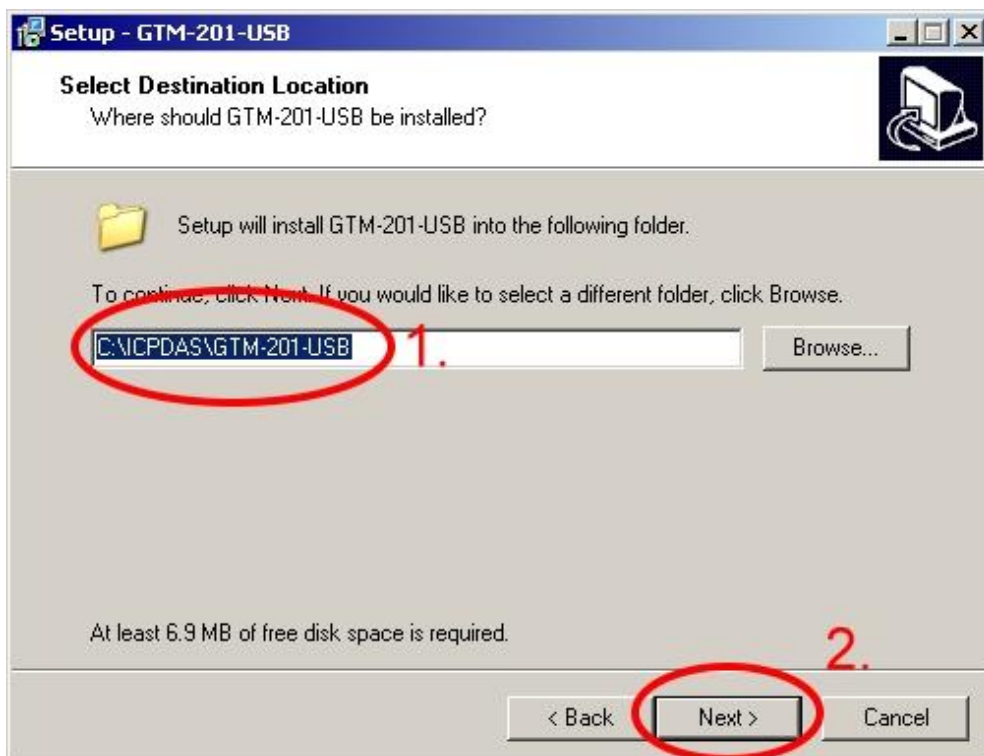

Step6. Select "Install"

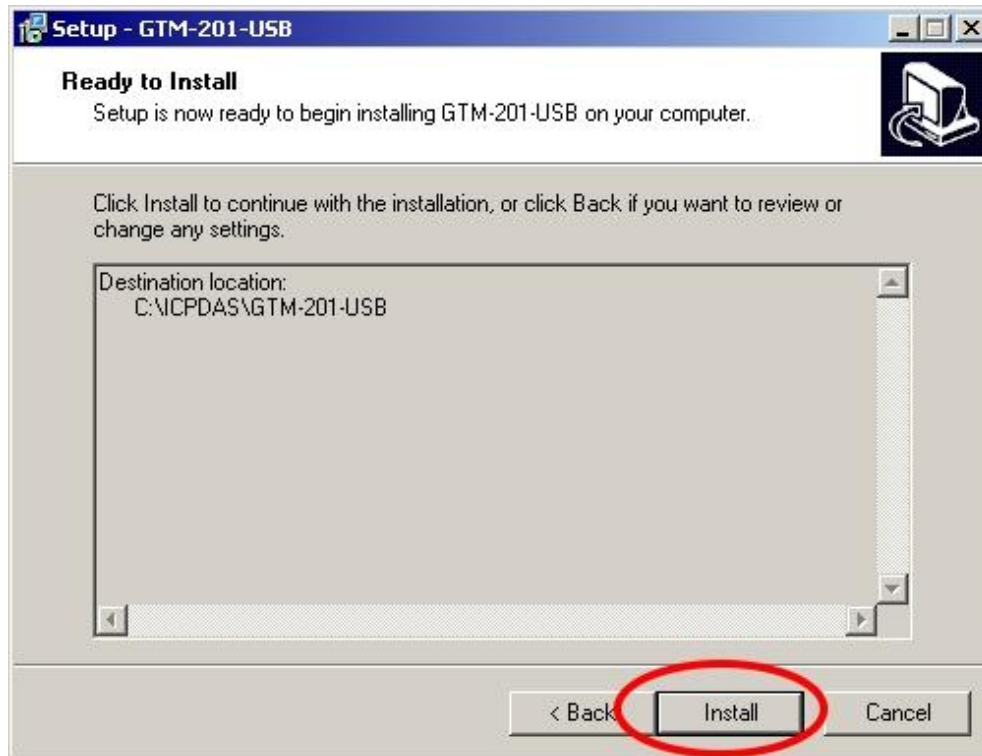

Step7. If the installation process has popped up new window that "Software Installation", please select "Continue Anyway"



Step8. Select "Finish"

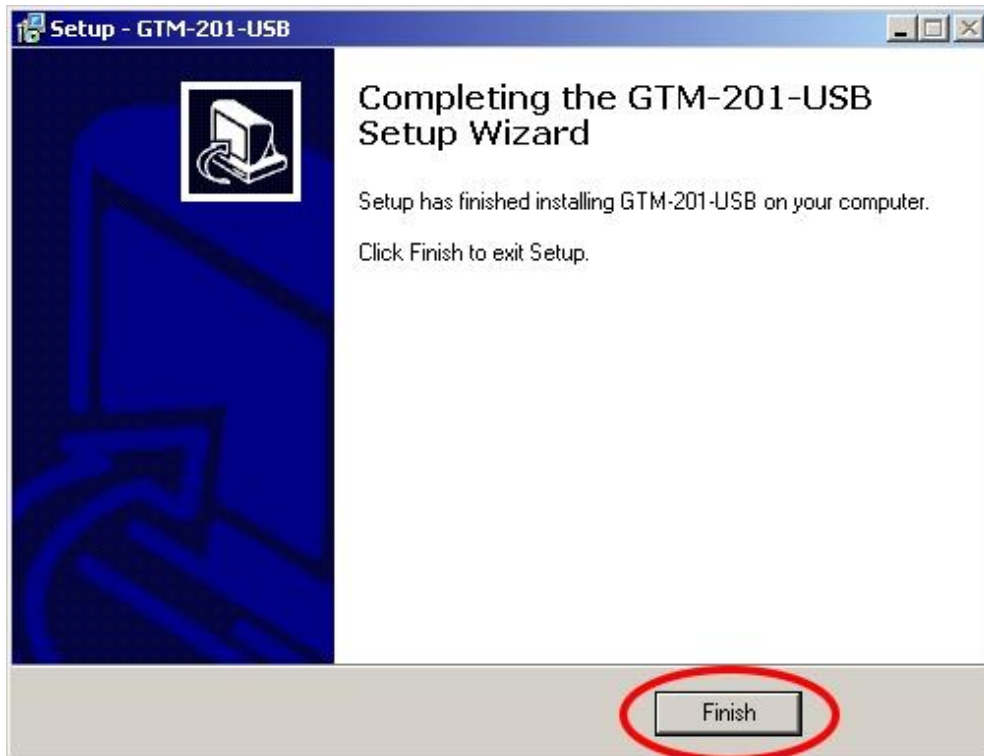

Step9. Please open "Device Manager" → check com port

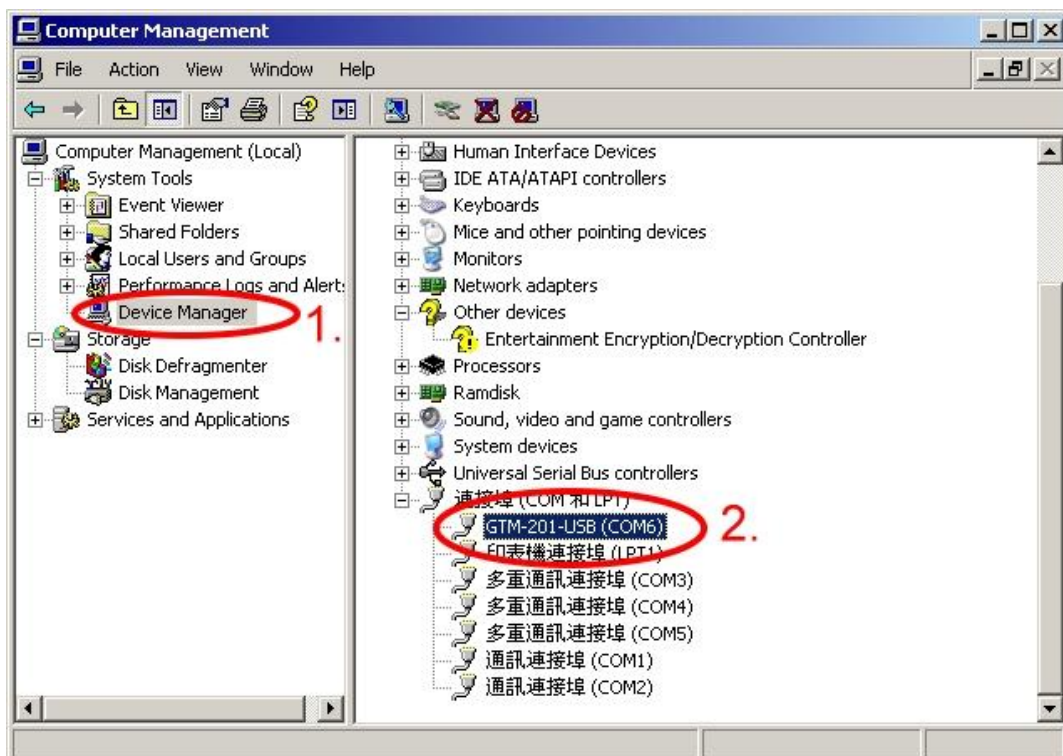

## 7.1.2 Manually install usb driver

Step1. Please install "GTM-201-USB\_v1.xx.exe" first.

Step2. Connect the GTM-201-USB and XPAC hardware with usb cable , then power on them.

Step3. Select "No, not this time" → Select "Next"



Step4. Select “Install from a list or specific location (Advanced)” → Select “Next”

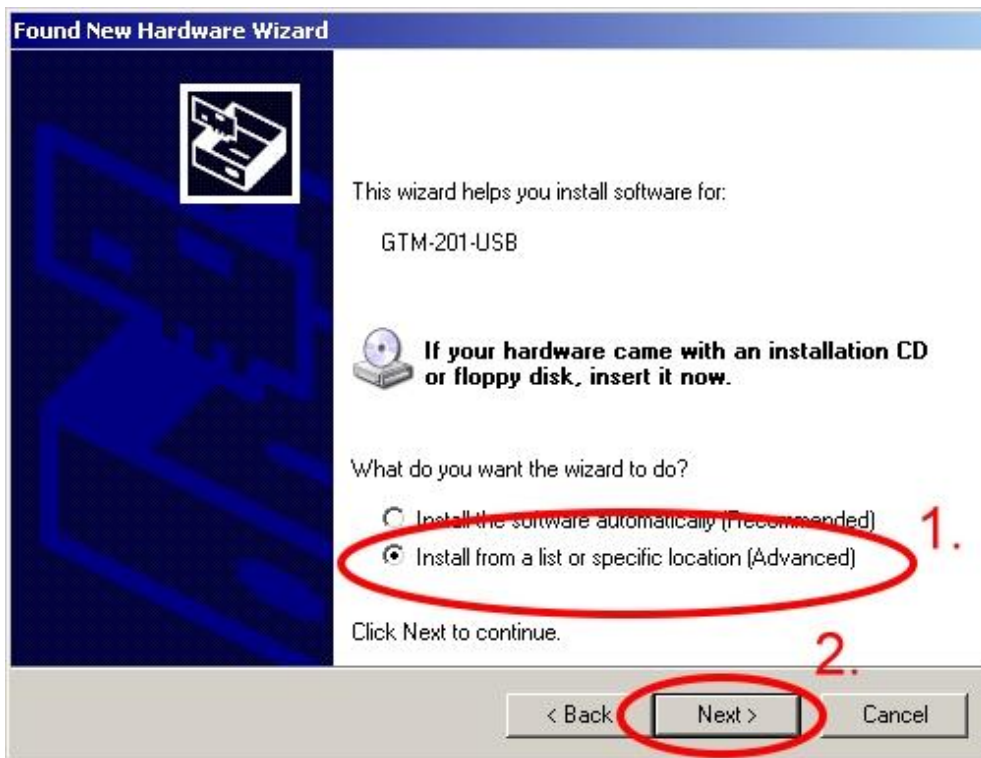

Step5. Select “Include this location in the search:” → Select “Browse” → Select “C:\ICPDAS\GTM-201-USB” → Select “OK”

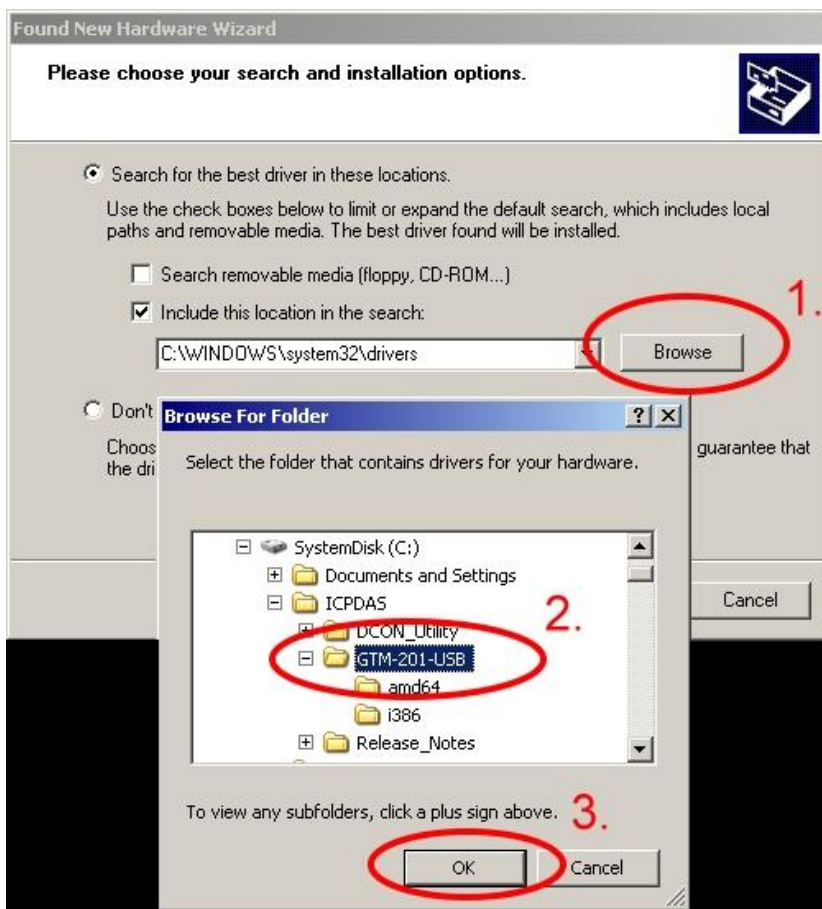



Step6. Select “Next”

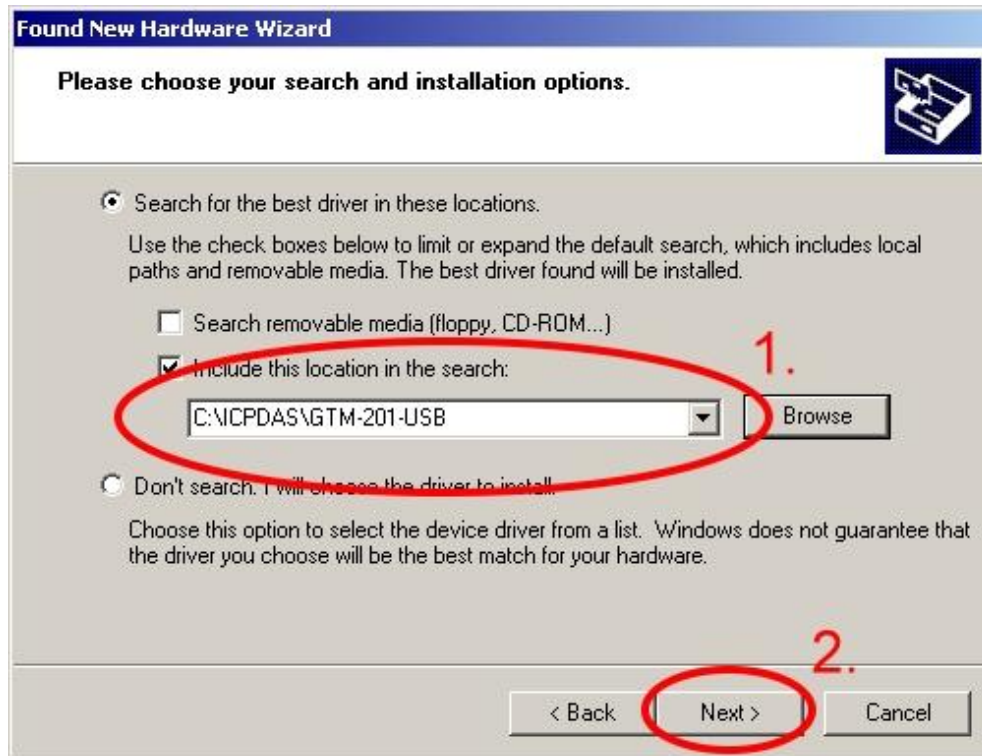

Step7. If it is pop-up a new windows that “Hardware Installation”, please select “Continue Anyway”

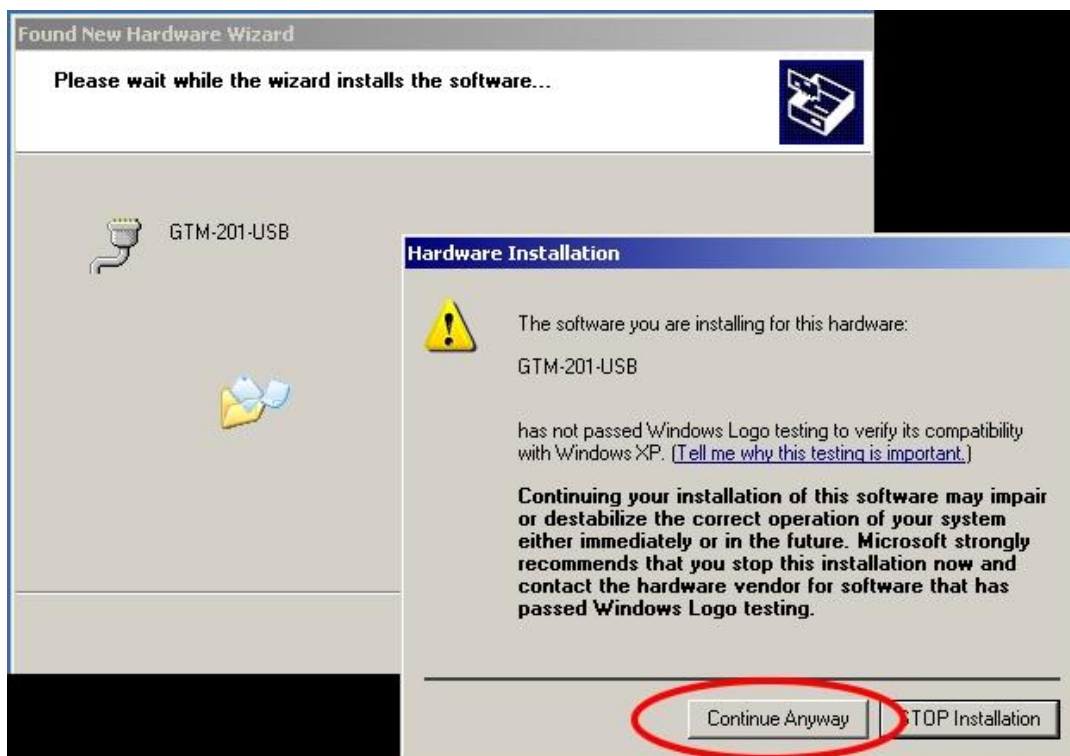

Step8. Select “Finish” to finish the usb driver installation.



Step9. Please open “Device Manager” → check com port

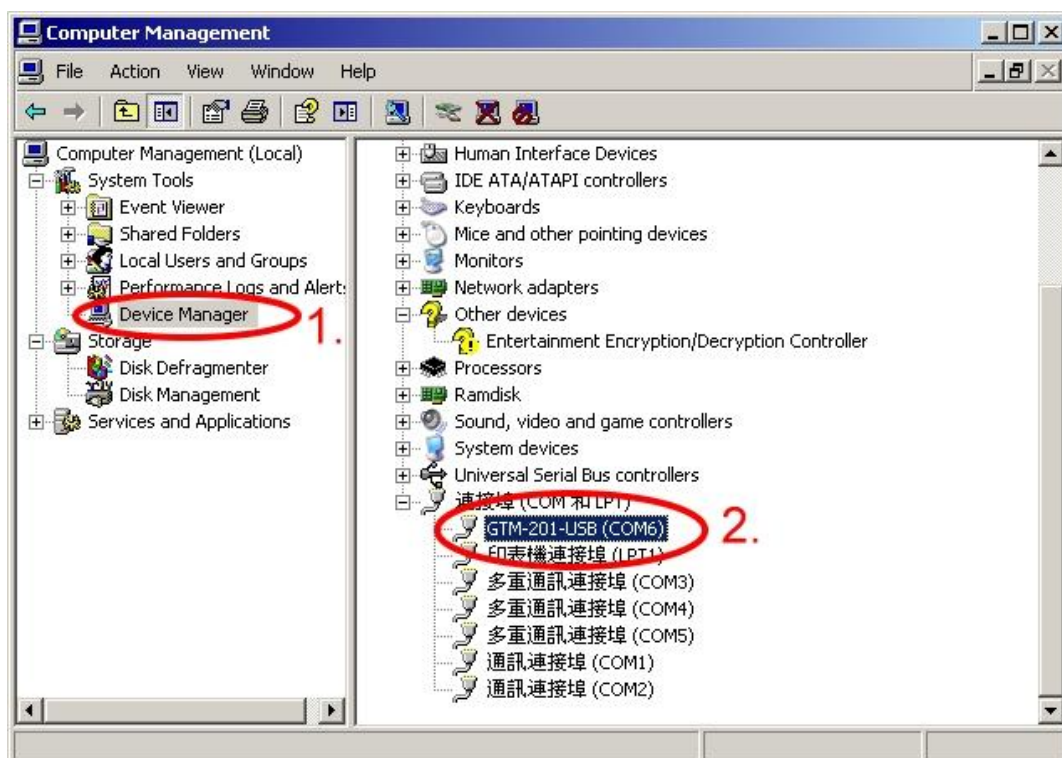

## 7.2 WinPAC – 8000 (WinCE)

- Step1. Copy “ICPDAS GTM-201-USB\_COM5\_WinPac.cab” to your WinPAC →  
 Double-Click ” ICPDAS GTM-201-USB\_COM5\_WinPac.cab” to install →  
 Select “OK”

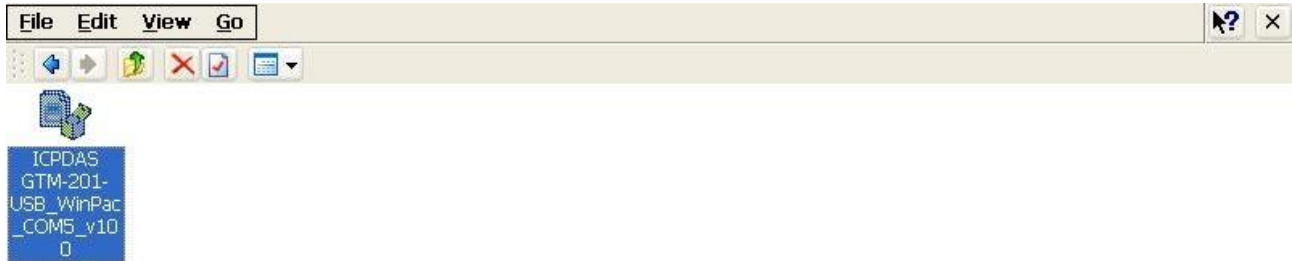

- Step2. Execute “WinPAC\_UTILITY” → File → Save and Reboot



## 7.3 LinPAC – 8000 (Linux)

Please install usb driver first and follow the command as below:

Type “insmod ftdi\_sio”

```
#  
# insmod ftdi_sio
```

**Remark: Please check O.S version. We have supported the GTM-201-USB module after O.S version 1.2.**

## Chapter 8 Software Reset

### 8.1 Software Reset

8.1.1 We Provide a Software Reset command for the user to reset the modem.

Step1. Please open Hyper Terminal, and open the COM Port of the GTM-201.

Step2. type the command “@ICPDASRESET”, and then don't send any data to GSM modem in 100ms. The modem will be reset.

Revised Note:

Version	By	Date	Description
1.00	Yide	2009/06/02	Release
1.01	Yide	2009/07/28	Release
1.0.2	Yide	2009/11/17	Modify
1.0.3	Yide	2009/12/31	Modify
1.04	Yide	2010/05/19	Modify
1.05	Malo	2012/3/27	Add chapter 8
1.06	Malo	2013/07/25	Add Soft Reset Command for GTM-201-USB