

ZT-2570/ZT-2571

User Manual

Warranty

All products manufactured by ICP DAS are under warranty regarding defective materials for a period of one year, beginning from the date of delivery to the original purchaser.

Warning

ICP DAS assumes no liability for any damage resulting from the use of this product. ICP DAS reserves the right to change this manual at any time without notice. The information furnished by ICP DAS is believed to be accurate and reliable. However, no responsibility is assumed by ICP DAS for its use, not for any infringements of patents or other rights of third parties resulting from its use.

Copyright

Copyright © 2013 by ICP DAS. All rights are reserved.

Trademark

Names are used for identification only and may be registered trademarks of their respective companies.

Technology Support

If you have any problems, please feel free to contact us via email at service@icpdas.com

Table of Content

1	Introduction of ZigBee.....	1
2	Introduction to the ZT-257x module.....	2
3	Information to the Hardware.....	4
3.1	Specifications.....	4
3.2	ZT-257x Front View.....	6
3.3	Dimensions (Units: mm).....	8
3.4	Block Diagram.....	9
3.5	Wire Connection.....	9
4	Setting up the ZT-257x module.....	10
4.1	Introduction of Configurations.....	10
4.2	Connecting the Power and Host PC.....	19
4.3	Configure ZigBee via Utility (Serial/Ethernet).....	21
4.4	Configure ZigBee via Browser (Ethernet).....	25
4.5	Configuration Example.....	30
4.5.1.	Data Transparent.....	31
4.5.2.	Modbus RTU communication.....	32
4.5.3.	Modbus RTU to Modbus TCP communication.....	34
4.5.4.	Modbus TCP communication.....	36
4.5.5.	Modbus TCP to Modbus RTU communication.....	39
4.5.6.	Both Modbus RTU & TCP communication.....	42
4.6	Test Communications.....	45
5	Applications.....	48
6.1	Technical Support.....	49
7	Appendixes.....	50
7.1	LED Indicator Status.....	50
7.2	DCON/MODBUS Device Communication.....	51
7.3	Non-addressable Device Communication.....	53

What's in the shipping package?

The package includes the following items:



ZT-257x Device



ANT-124-05

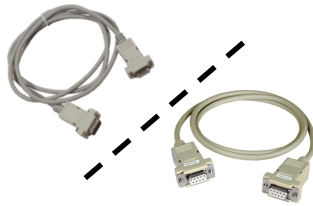

CA-0915 (ZT-2570) /
CA-0910N (ZT-2571)



Release Note



CD

If any of these items are missing or damaged, please contact your local distributor for more information. Save the shipping materials and cartons in case you want to ship the module in the future.

More Information

■ Documentation :

CD: \Napdos\ZigBee\ZT_Series\Document

http://ftp.icpdas.com/pub/cd/usbcd/napdos/zigbee/zt_series/document

■ Software :

CD: \Napdos\ZigBee\ZT_Series\Utility

http://ftp.icpdas.com/pub/cd/usbcd/napdos/zigbee/zt_series/utility

1 *Introduction of ZigBee*

What is ZigBee?

ZigBee is a specification for a suite of high level communication protocols using small, low-power digital radios based on an IEEE 802.15.4 standard for personal area networks. ZigBee devices are often used in mesh network form to transmit data over longer distances, passing data through intermediate devices to reach more distant ones. This allows ZigBee networks to be formed ad-hoc, with no centralized control or high-power transmitter/receiver able to reach all of the devices. Any ZigBee device can be tasked with running the network.

ZigBee Application

ZigBee is targeted at applications that require a low data rate, long battery life, and secure networking. ZigBee has a defined rate of 250 kbit/s, best suited for periodic or intermittent data or a single signal transmission from a sensor or input device. Applications include wireless light switches, electrical meters with in-home-displays, traffic management systems, and other consumer and industrial equipment that requires short-range wireless transfer of data at relatively low rates. The technology defined by the ZigBee specification is intended to be simpler and less expensive than other WPANs.

2 *Introduction to the ZT-257x module*

The Basis of ZT-257x Series Product

The ZT-2570 and ZT-2571 series modules are small-sized wireless ZigBee converters based on the IEEE802.15.4 standard that allow RS-232, RS-485 and Ethernet interface to be converted to a personal area ZigBee network. The typical transmission of ICP DAS ZT series ZigBee products is 700 meters (LOS, line of sight), with a transmission frequency range of between 2.405 GHz and 2.48 GHz, separated into 5 MHz sectors, providing 16 channels and 16384 PAN IDs. ZT-2000 series is not only a long distance wireless converter but also can act a ZigBee router to extend the transmission range and improve the quality of wireless signal.

ZT-2000 series products are specification for a suite of high level communication protocols using small, low-power digital radios module, which are fitted the ZigBee 2007 (ZigBee Pro) of ZigBee Alliance. In the ZigBee network, it is only allowed one ZigBee Host and called "ZigBee Coordinator", ZT-2570 series products, are used to initialize and manager the routing. In addition, One ZigBee network are able to manager 255 ZigBee router and responsible for receiving or bypassing data from parent or child node.

The Benefits of ZT-257x Series Product

A Windows compatible GUI configuration utility is available. The utility allows users to set different configurations based on the type of application, together with several of required ZigBee variables such as Pan ID. The friendly user interface is also helping user be familiar with ZT-2000 series.

For more information, please refer to the relevant documents for these devices, which can be found at following link:

http://ftp.icpdas.com/pub/cd/usbcd/napdos/zigbee/zt_series/document

3

Information to the Hardware

3.1 Specifications

Part Number		ZT-2570 (ZigBee Coordinator)	ZT-2571 (ZigBee Router)
Hardware			
CPU		80186, 80 MHz or compatible	
Temporary Buffer Size		2300 Bytes	
LED	Green	ZigBee Net	
	Yellow	ZigBee RxD	
	Red	ZigBee Power	
Communication Interface (COM 0)			
RS232	RS-232 (TxD, RxD and GND);		
	D-Sub 9 Female, Non-isolated		D-Sub 9 Male, Non-isolated
RS-485	RS-485 (DATA+, DATA-; internal ASIC self-tuner); Non-isolated		
Baud Rate	1200 ~ 115200 bps		
Data Bit	7, 8		
Parity Check	Even, Odd, None, Space and Mark		
Stop Bit	1, 2		
Communication Interface (Ethernet)			
Ethernet	10/100 Base-TX (Auto-negotiating, auto_MDI/MDI-X, LED indicators)		
Power			
Protection	Power reverse polarity protection		
EMS Protection	ESD, Surge, EFT		
Required Supply Voltage	+10V _{DC} ~ +30V _{DC}		
Power Consumption	2.5 W (Max.)		

Mechanism	
Casing	Plastic
Flammability	UL 94V-0 materials
Dimensions	33 mm x 78 mm x 107 mm (W x L x H)
Installation	DIN-Rail
Environment	
Operating Temperature	-25 °C ~ +75 °C
Storage Temperature	-40 °C ~ +80 °C
Relative Humidity	5 ~ 95% RH (non-condensing)
Wireless	
RF Channel	16
RF Transmit Power	11 dBm
Antenna (2.4GHz)	5 dBi Omni-Directional Antenna
Transmit Range (LOS)	700 m (Typical)
Max. Slaves Supported	255
EMC	CE/FCC, FCC ID

WARNING! HOT SURFACE DO NOT TOUCH



In compliance with the EN 60950-1 declaration, ZT-2000 series modules are **NOT** portable devices and should be DIN-Rail mounted. The ZT-2000 series is **NOT** designed for the general public. Although the metal areas on the external surfaces of the equipment have no dimensions exceeding 50 mm, you should still be careful not to touch these surfaces while mounting the device, or during normal use.

3.2 ZT-257x Front View

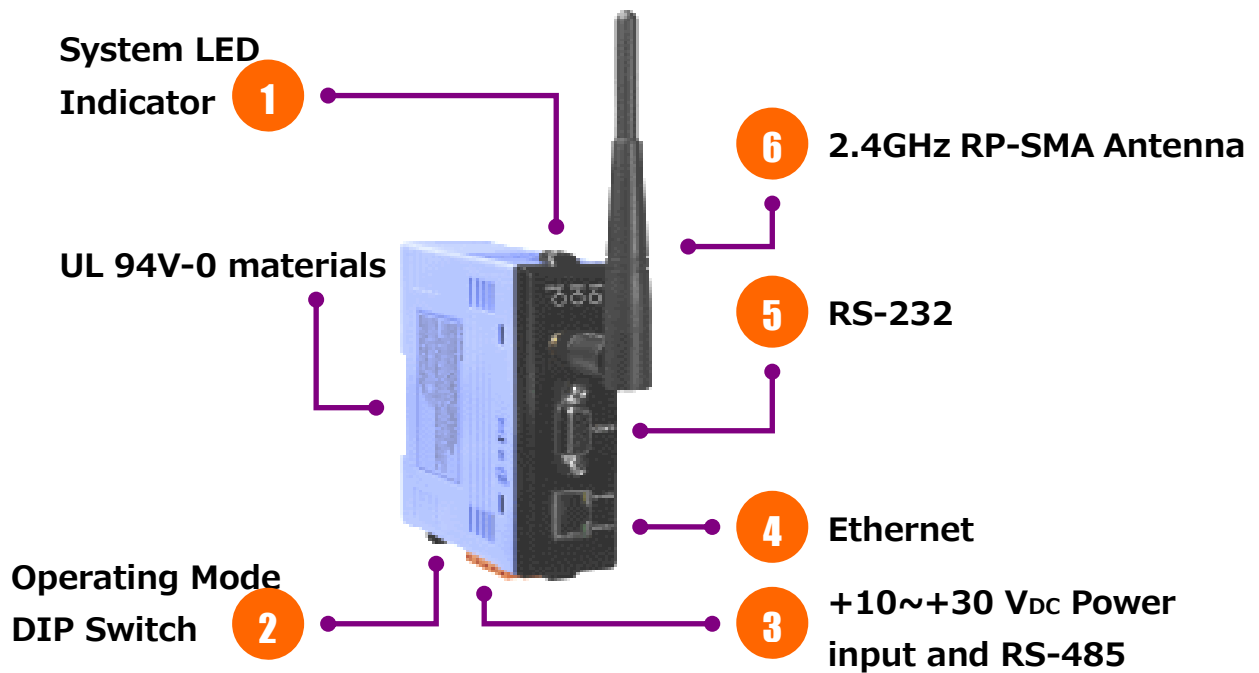

1. LED Indicator Status

LED Indicator	LED Color	Explain
ZigBee Net	Green	The status of ZigBee network.
ZigBee RxD	Yellow	The status of ZigBee communication
ZigBee PWR	Red	The status of module board

※ For more details, please see the section 6 troubleshooting.

2. Operating Mode DIP Switch

- ZBSET : Configuration mode is able to use browser or ZT Configuration Utility to configure via the Ethernet, RS-232 or RS-485 interface.
- ZBRUN : Transmit mode is used to transmit data to the remote device.
- ZBINIT : Operating system initial state, it is used to update firmware.

3. RS-485 and +10 ~ +30 V_{DC} Power input

- The RS-485 and RS-232 are communicable via the same UART.
- The ZigBee PWR indicator will be steady light if correct power input.

4. Ethernet

- The port RJ-45 jack is the 10/100 Base-TX Ethernet port.

5. RS-232

- The RS-485 and RS-232 are communicable via the same UART.

6. 2.4 GHz RP-SMA Omni-directional Antenna

- If there is any requirement for extension cable, it must be a connector with the type RPSMA and resistance 50 Ohm. Ex. 3S001-1, 3S003-1...etc

3.3 Dimensions (Units: mm)

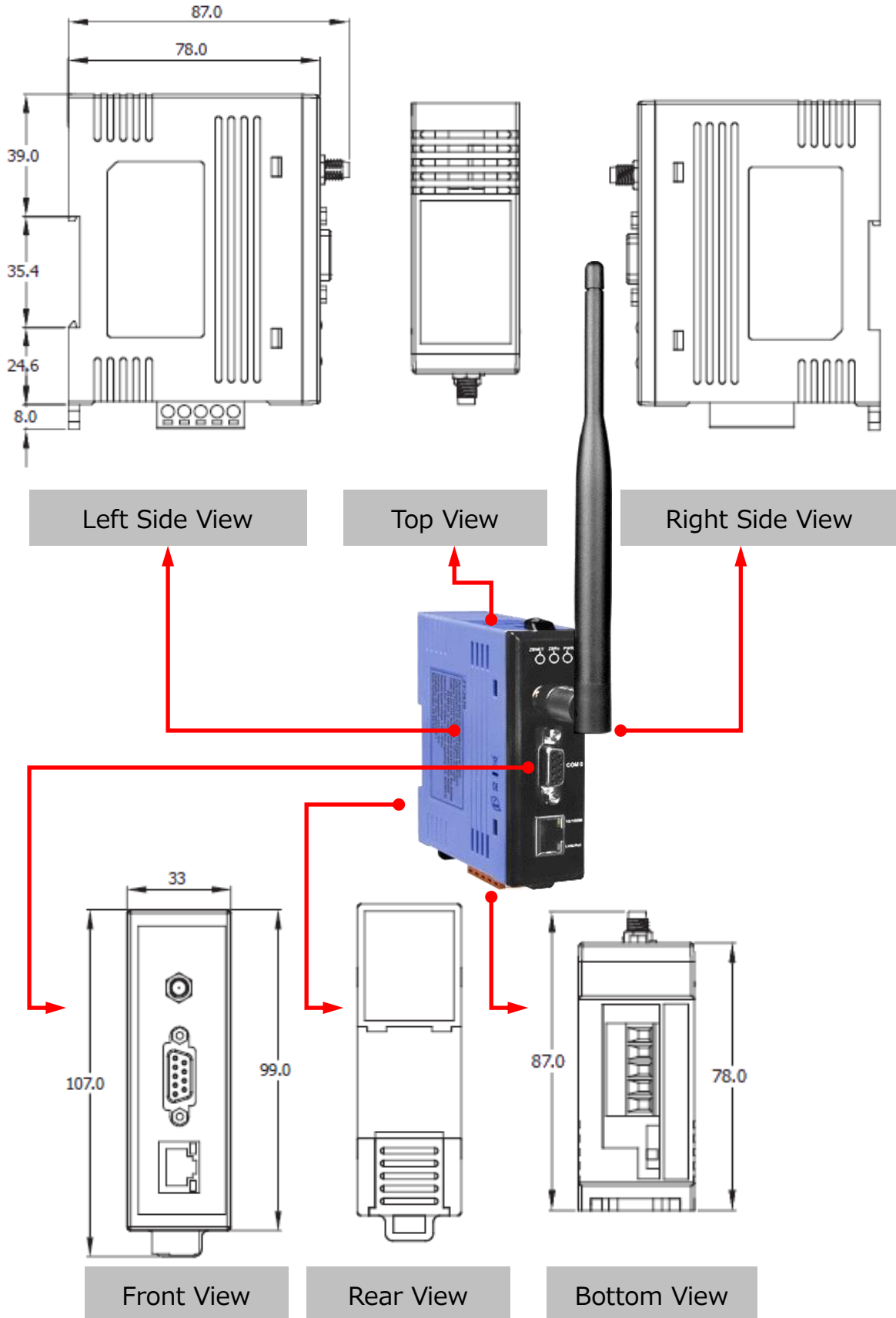

3.4 Block Diagram

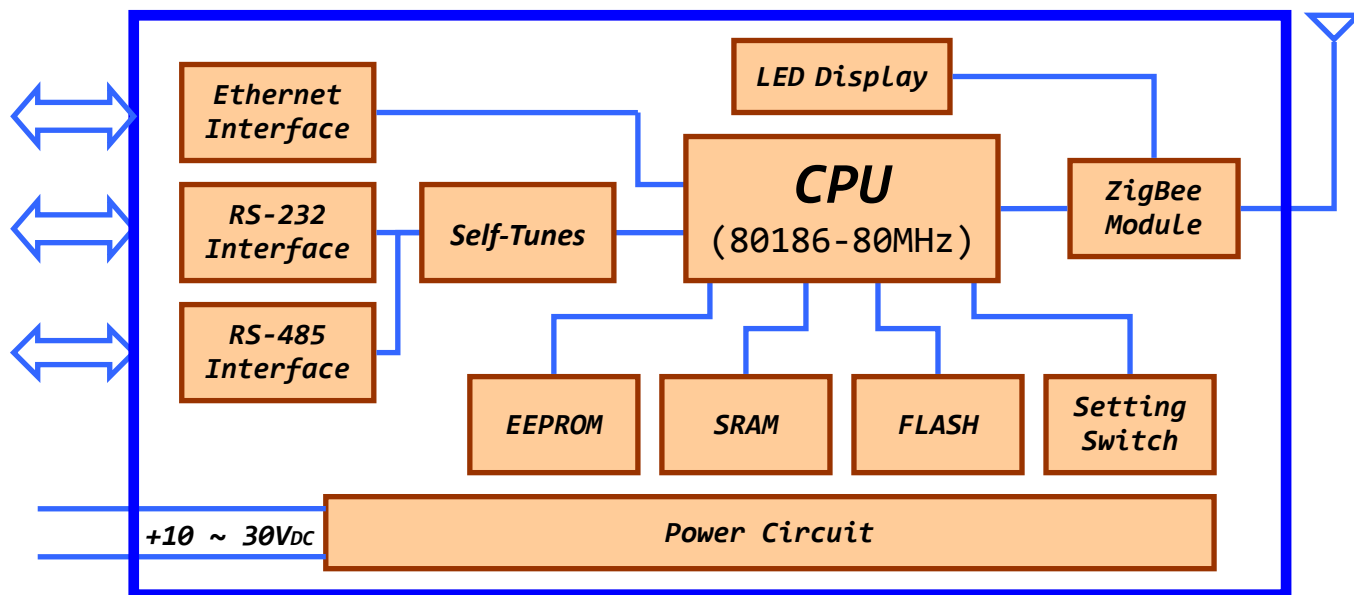

3.5 Wire Connection

1. RS-232

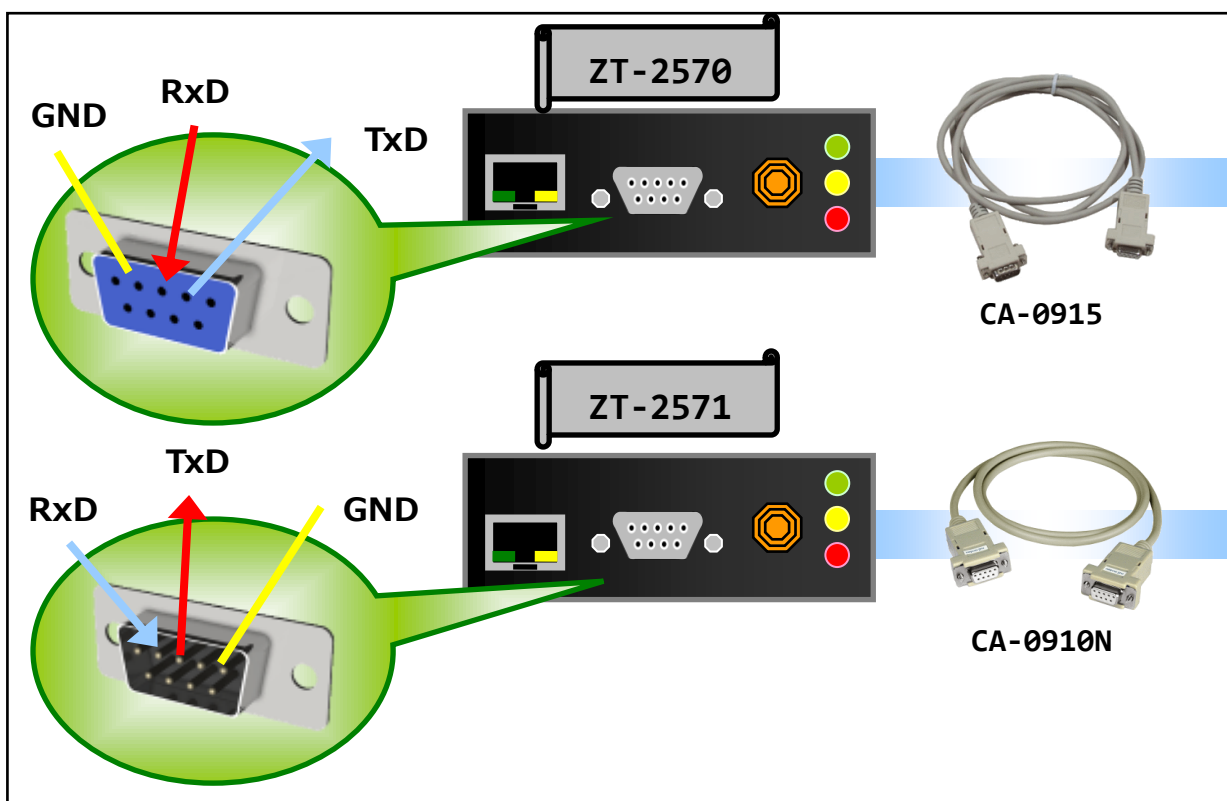

2. RS-485

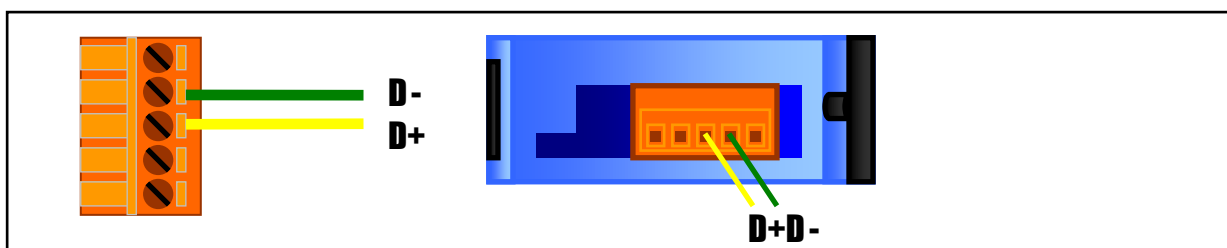

4 *Setting up the ZT-257x module*

4.1 Introduction of Configurations

1. **“Pan ID”** is the group identity of a ZigBee network

The identity number must be the same if they are in the same ZigBee network.

(Valid values range from 0x0000 to 0x3FFF)

2. **“Node ID”** is the identity of the ZigBee module.

The identity number must be unique if it is in the same ZigBee network as other ZigBee module. (Valid values range from 0x0001 to 0xFFFF7 for a ZigBee Router, but is fixed to 0x0000 for a ZigBee Coordinator)

3. **“RF Channel”** indicates the radio frequency channel.

The value must be set to the same channel if the module is in the same ZigBee network as other ZigBee modules.

<i>Channel</i>	<i>0x00</i>	<i>0x01</i>	<i>.....</i>	0x0F
Frequency(MHz)	2405	2410	<i>.....</i>	2480

Use application tools or analyzers to detect the wireless signal, chose a RF Channel which has not been occupied.

e.g. Wifi Analyzer

As below the screenshot shown, there were several WLANs over the channel 1, 6 and 11. Referring to the channel table of WiFi and ZigBee, the channels of ZigBee 4, 9, E and F are not overlap with WLAN. So, the RF Channel 4, 9, E and F of ZigBee are recommended in this case.

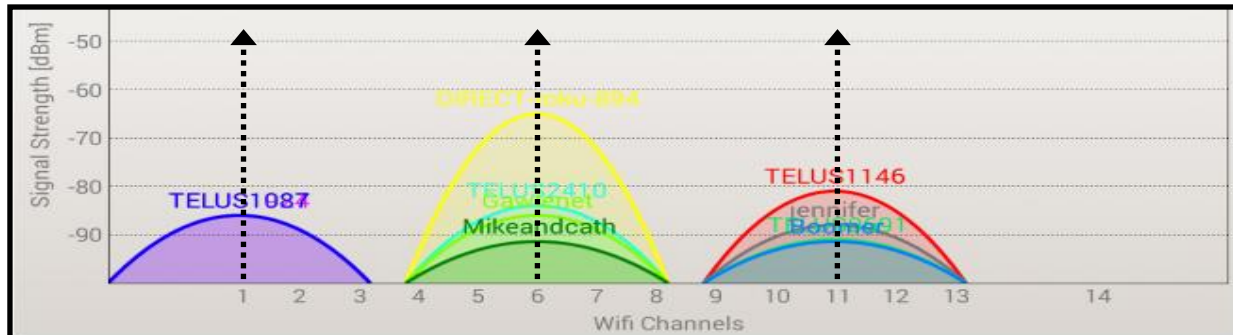

ZigBee	WiFi													
CH 0 (2405)	CH 1 (2412)	CH 2 (2417)	CH 3 (2422)	CH 4 (2427)	CH 5 (2432)	CH 6 (2437)	CH 7 (2442)	CH 8 (2447)	CH 9 (2452)	CH 10 (2457)	CH 11 (2462)	CH 12 (2467)	CH 13 (2472)	CH 14 (2484)
CH 1 (2410)														
CH 2 (2415)														
CH 3 (2420)														
CH 4 (2425)														
CH 5 (2430)														
CH 6 (2435)														
CH 7 (2440)														
CH 8 (2445)														
CH 9 (2450)														
CH A (2455)														
CH B (2460)														
CH C (2465)														
CH D (2470)														
CH E (2475)														
CH F (2480)														

- RF Channel Table to ZigBee(802.15.4) and WLAN(IEEE 802.11b/IEEE 802.11g)

4. Communication Speed (Broadcasting Frame Sending Interval)

The packet payload of ZT-2000 series devices is 79 bytes. Data above 79 bytes will be transmitted in several packets. This parameter decides the broadcasting frame sending interval time to avoid the network overloading. User only fills in the number of ZT-2000 slaves nearby the ZigBee Coordinator.

➤ Example:

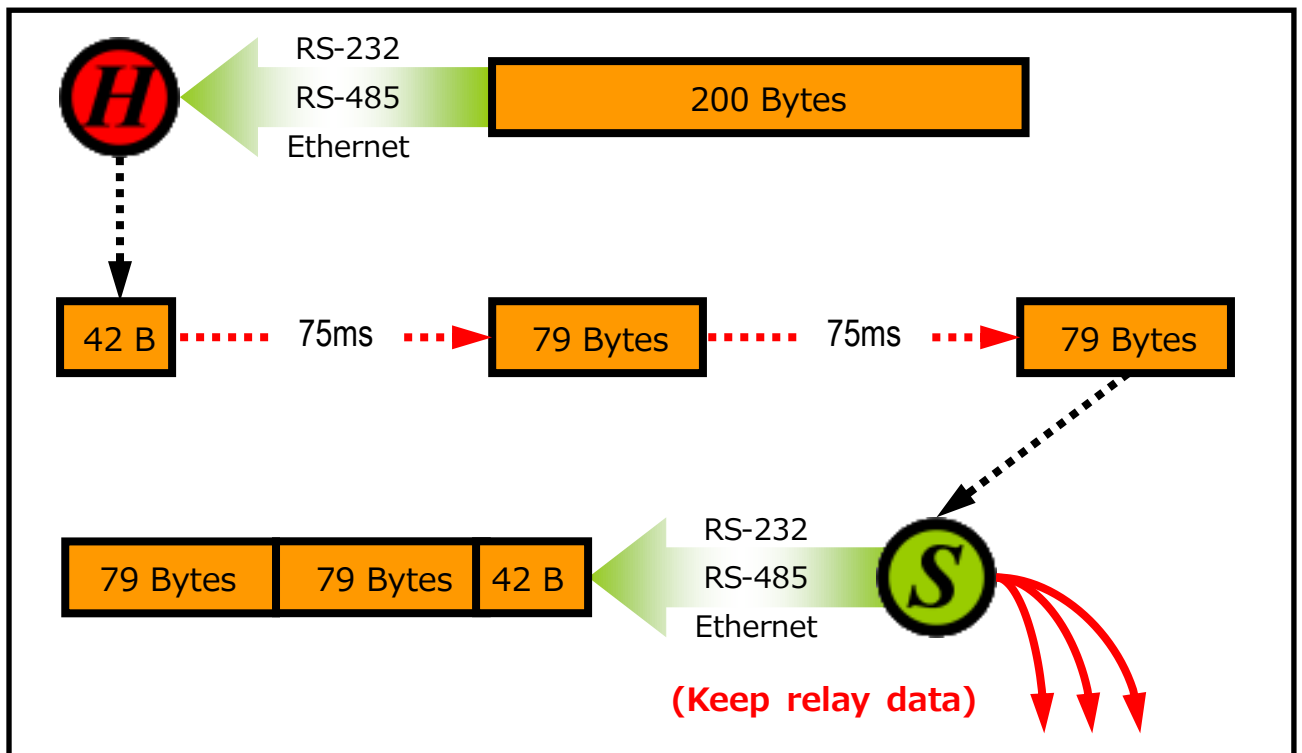
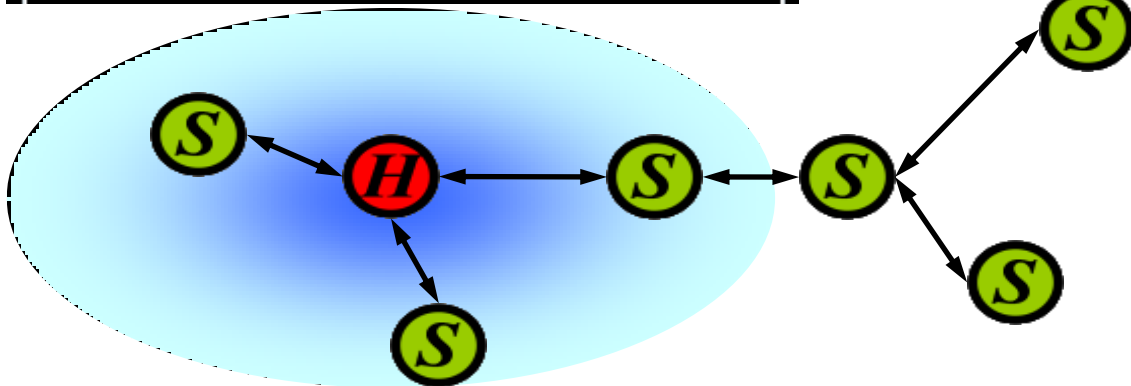
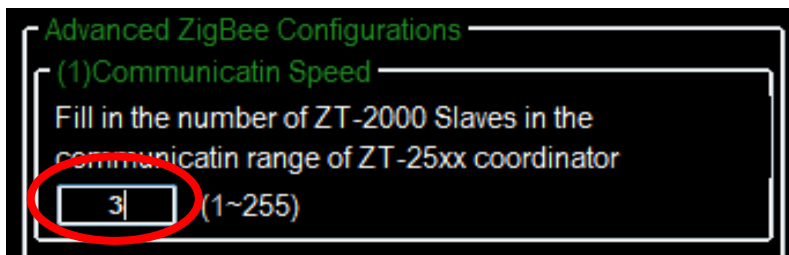

5. **“RF Power”** denotes the wireless transmit power value.

Code	Note
<i>0x0F</i>	Typical Maximum
<i>0x08</i>	Fit the CE/FCC certification
0x00	Typical Minimum

※ *The parameter adjustment purely personal behavior, ICP DAS can not guarantee to pass CE/FCC certification if adjusting this parameter, nor assume any liability because of the adjustment parameters derived from the RF Power.*

6. **“Baud rate & Data Format”**

These values are based on the configuration of the serial port.

Item	Specification
Data Format	N81, N82, O71, O81, E71, E81, S81, M81
Baud Rate	1200 ~ 115200 bps

7. Communication Interface is three types provided as below.

The communication interface to each ZT-25xx device are independent, so the configuration can be set independently according to the user needs, as illustrated in the diagrams below.

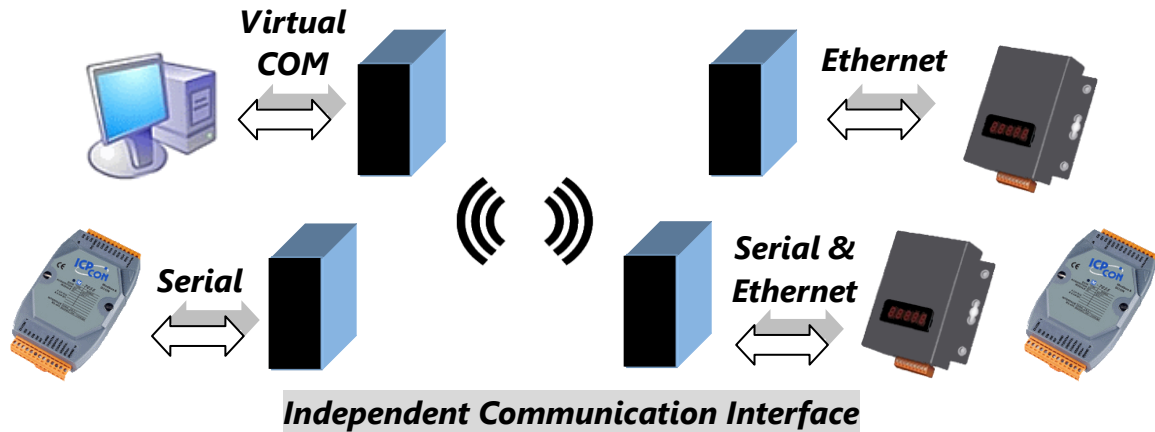

a. Serial Port

RS-232 and RS-485 are enabled and it allows working with Ethernet at the same time.

b. Ethernet

Either TCP Server or TCP Client is enabled and it allows working with RS-232 or RS-485 at the same time.

c. Virtual COM

Virtual COM driver needs to be installed in the desktop and the COM is working independently to the serial and Ethernet.

Download: <http://www.icpdas.com/products/Software/VxComm/vxcomm.htm>

※ Note: Please select "Fixed baud rate" if the virtual COM is not in the 115200 bps and N81 format.

Fixed baudrate, use current settings of servers.

Port	Virtual COM	Baudrate
Port I/O	Reserved	N/A
Port 1	Reserved	Dynamic
Port 2	COM11	Fixed

8. Configurations of TCP :

ZT-257x device	
IP	IP must be the same segment with LAN segment of desktop
Mask	Mask must be the same with LAN of desktop
Gateway	Gateway must be the same with LAN of desktop
Port	User port will listen to connection request when it acts TCP Server
Connection Target (Need to set when it acts TCP Client)	
IP	The IP of connection target
Port	The port of connection target

9. "Application Mode" can be changed and used for certain specific purpose.

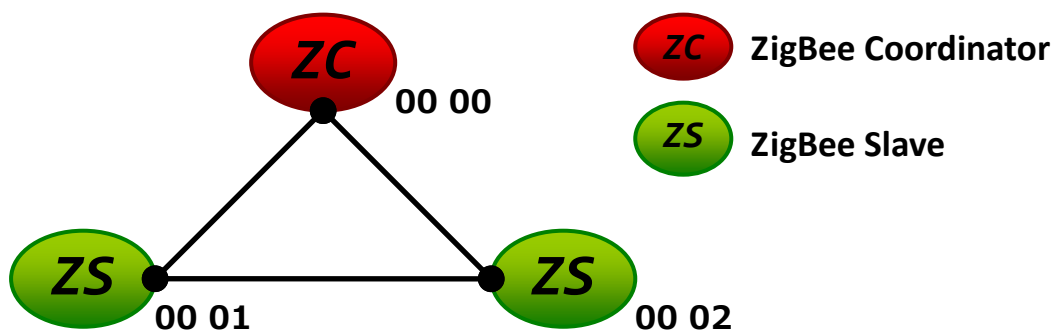

The above schematic diagram is showing what the difference of using different application modes.

a. Transparent Mode is the default application mode, and always transmits data to the remote device via broadcasting. Unless there are specific purposes, the application mode can be retained as default.

The mode always bypasses data to remote side via broadcasting. If there is no particular purpose, user only keeps this application mode.

Module	Frame Type	Note
ZT-2570	Broadcast	Data will be sent to all ZigBee slaves
ZT-2571	Unicast	Data will only be sent to the coordinator

[Eg1] When ZT-2570 ZigBee Host sends "DATA_01" via broadcasting frame,
 →Both of the ZigBee slave 0x0001 and 0x0002 will receive the DATA_01.

※ *Broadcasting type frame, data will be sent to every ZigBee slaves in the same ZigBee network*

[Eg2] When the ZigBee slave 0x0001 sends "DATA_02" via unicast frame,
 →Only ZT-2570 receives DATA_02.

※ *Unicast type frame, data will only be sent to the ZigBee host)*

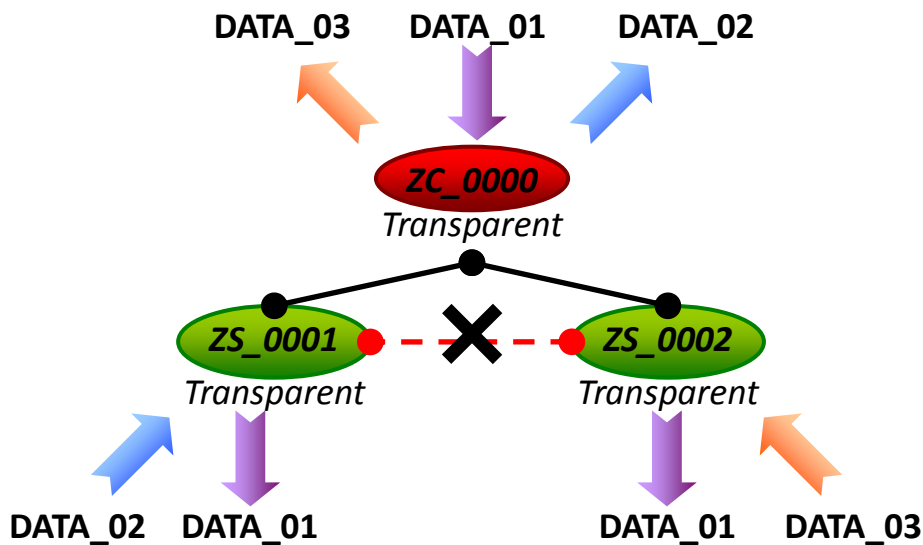

※ There is an "Advanced Settings" for some specific users, please refer the section 7.3 "Non-addressable Device Communication" for more information.

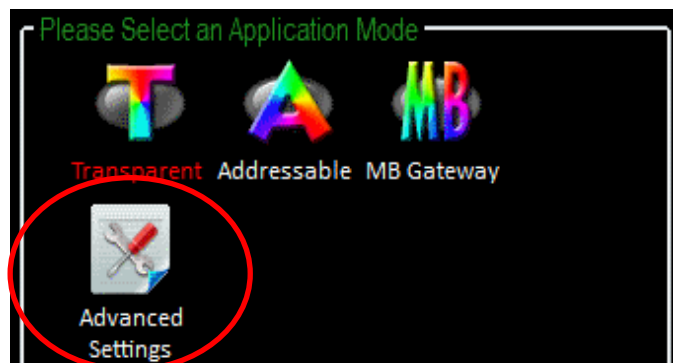

b. Addressable Mode is an advanced application mode and it is used to send data to specific ZigBee nodes. It is not only used to transmit data to specific ZigBee slaves from host but also transmit data between ZigBee slaves. A 5-byte ASCII code should be added as an index before the data.

Module	Frame Type	Note
ZT-2570 ZT-2571	Unicast	Data will be sent to a specific ZigBee slave. Format: ":AAAA" + Data

[Eg1] When ZT-2570 ZigBee Host sends ":0001DATA_01" via unicast frame,
→ Only the ZigBee Slave 0x0001 receives DATA_01.

※ *Unicast type frame, data will be only sent to the specific ZigBee node)*

[Eg2] When ZigBee slave 0x0001 sends ":0002DATA_02" via unicast frame,
→ Only the ZigBee Slave 0x0002 receives DATA_02.

※ *Unicast type frame, data will be only sent to the specific ZigBee node*

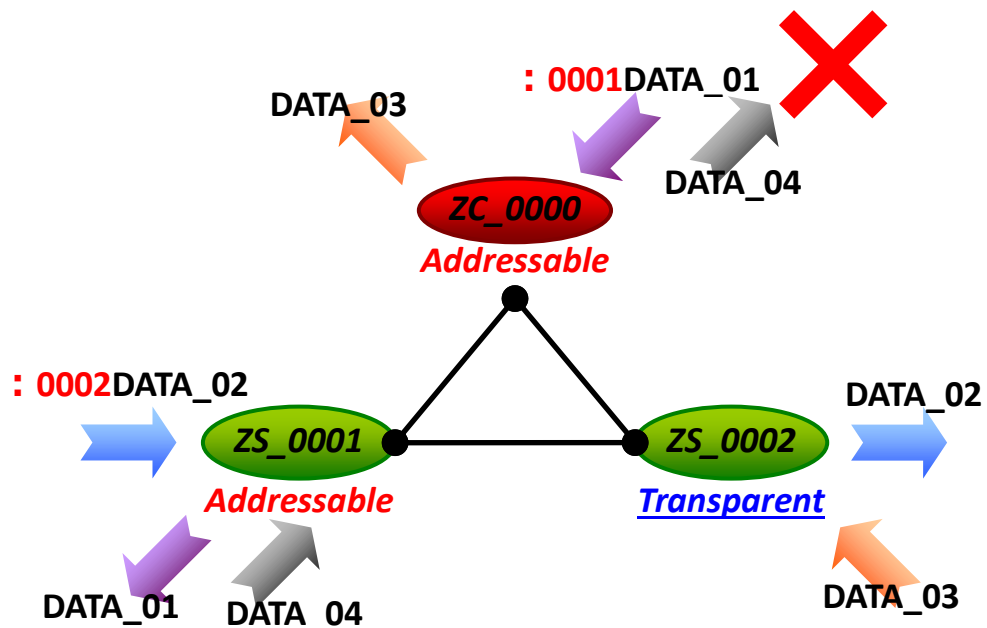

※ There is an "Advanced Settings" for some specific users, please refer the section 7.3 "Non-addressable Device Communication" for more information.

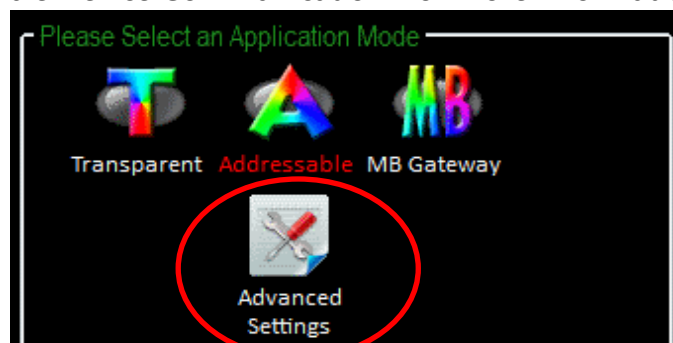

- c. **Gateway Mode** is an advanced application mode and it is used to convert the Modbus protocol. Data is regarded as Modbus RTU if communicates through via RS-232 or RS-485, else data is regarded as Modbus TCP if it communicates via the Ethernet.

Module	Frame Type	Note
ZT-2570	Broadcast (Default)	Data is sent to all of ZigBee slaves
	Unicast (Advanced)	Data will be sent to a specific ZigBee slave. The Address of DCON/Modbus command is regarded as destination ZigBee address
ZT-2571	Unicast	Data only be sent to coordinator

[Eg1] When ZT-2570 receives data "MRTU_CMD_01" from serial port,

→ZT-2571 will output the data "MRTU_CMD_01" directly to serial port.

→ZT-2571 will convert protocol then output "MTCP_CMD_01" to Ethernet.

※ *Broadcasting type frame, data will be sent to every ZigBee slaves in the same ZigBee network)*

[Eg2] When ZT-2570 receives data "MTCP_CMD_02" from Ethernet,

→ZT-2571 will convert protocol then output "MRTU_CMD_01" to serial port.

→ZT-2571 will output the data "MTCP_CMD_01" directly to Ethernet.

※ *Broadcasting type frame, data will be sent to every ZigBee slaves in the same ZigBee network)*

[Eg3] When ZT-2571 transmits the acknowledgement "MRTU_ACK_03",

→ZT-2570 will response the acknowledgement "MRTU_ACK_03" directly to serial port.

→ZT-2570 will convert protocol then output "MTCP_CMD_01" to Ethernet.

※ *Unicast type frame, data will only be sent to the ZigBee host)*

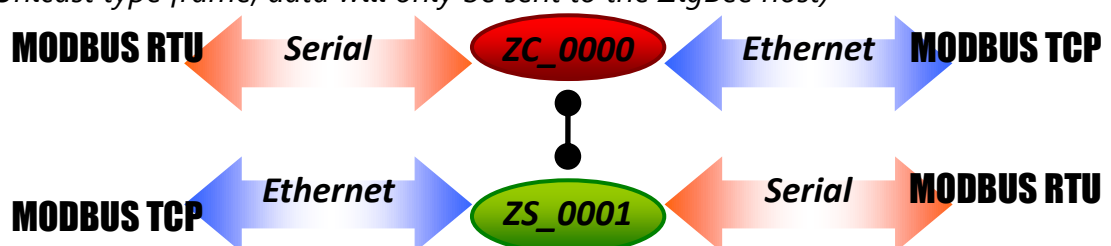

- ※ There is an "Advanced Settings" to the Gateway Mode for some specific users, please refer the section 7.2 "DCON/Modbus Device Communication" for more information.

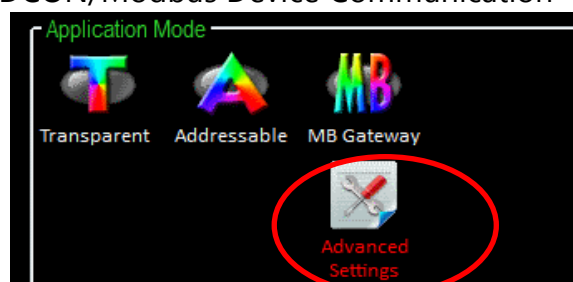

4.2 Connecting the Power and Host PC

Step 1. Confirm that the DIP switch is set to the “ZBSET” position.

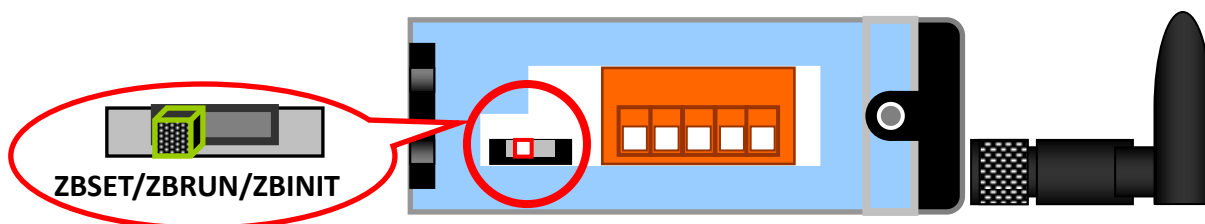

Step 2. Connect the DC.GND and DC.+Vs pins with 10 to 30V power supply.

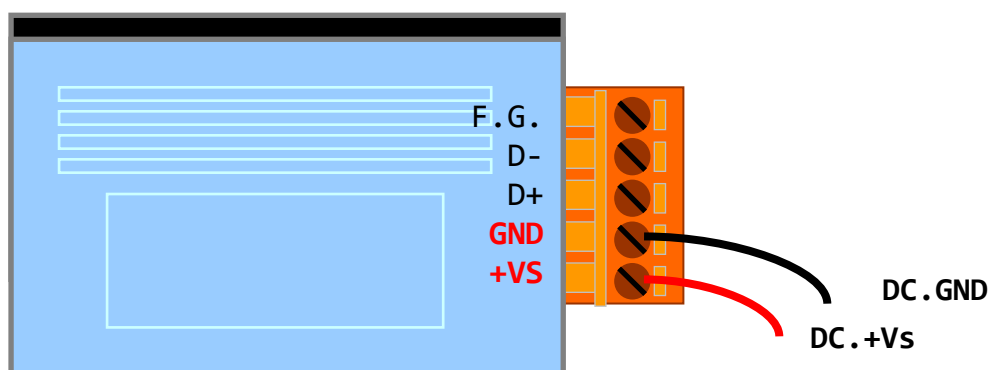

SAFTY INSTRUCTION NOTES



Before connecting the power source to the power input pins, ensure that both the installation of the unit in the completed system, and the DC power source (SELV, Limited Power Source) that is intended to be connected to the power input pins (DC.+Vs / DC.GND) comply with the requirements of EN 60950-1.

Step 3. Connect RS-232, RS-485 or Ethernet interface to configure the ZT-257x.

➤ RS-232 :

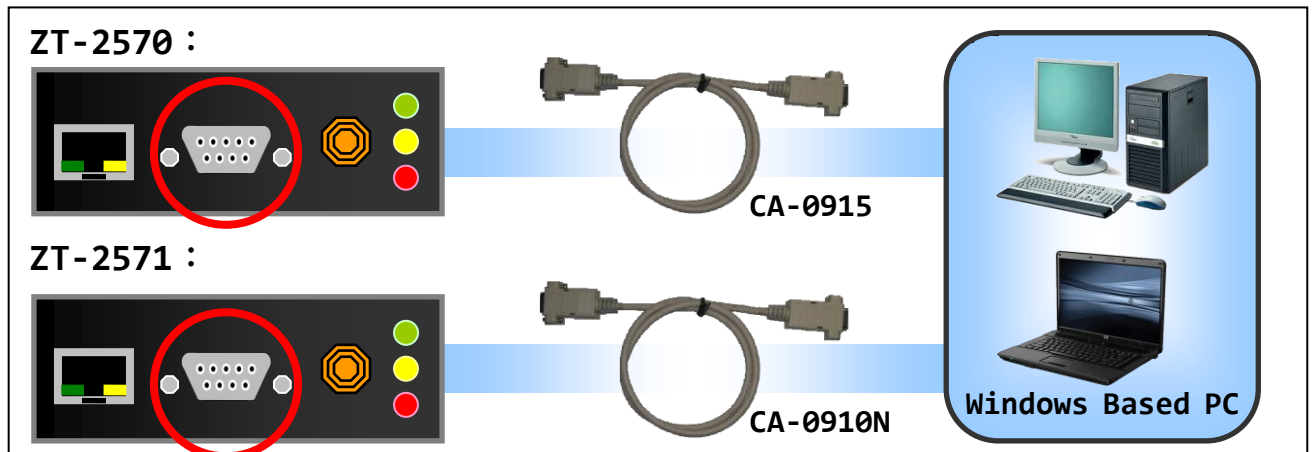

➤ RS-485 :

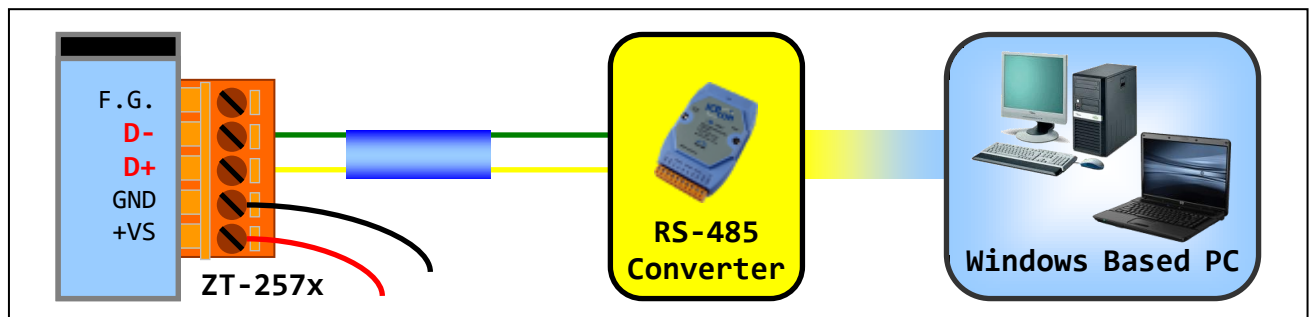

➤ Ethernet :

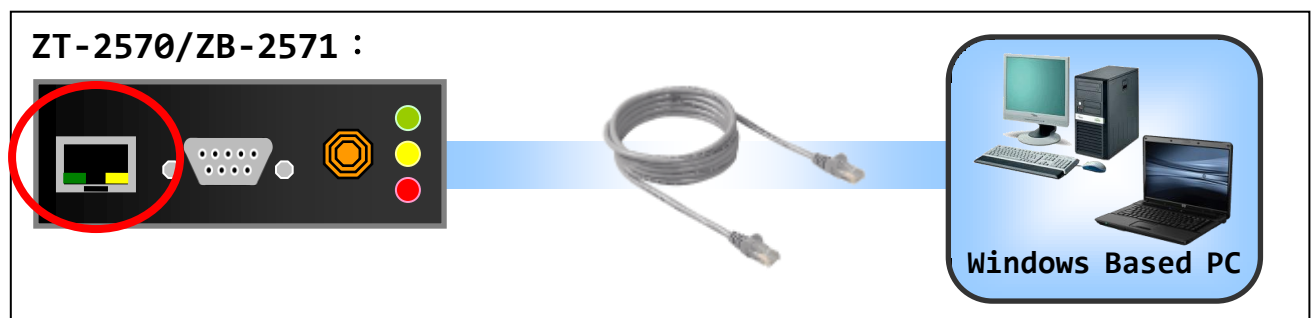

Step 4. Enable the power. It means that the ZT-257x start-up procedure has been completed. If the red LED has changed from blinking to a steady light.

4.3 Configure ZigBee via Utility (Serial/Ethernet)

Step 1. Launch the software "ZT Configuration Utility" and select the [ZT Series].



Step 2. Single click either the "Serial Port or Ethernet" icon with the correct number of "COM Port or IP Address" that is used to select the communication interface.

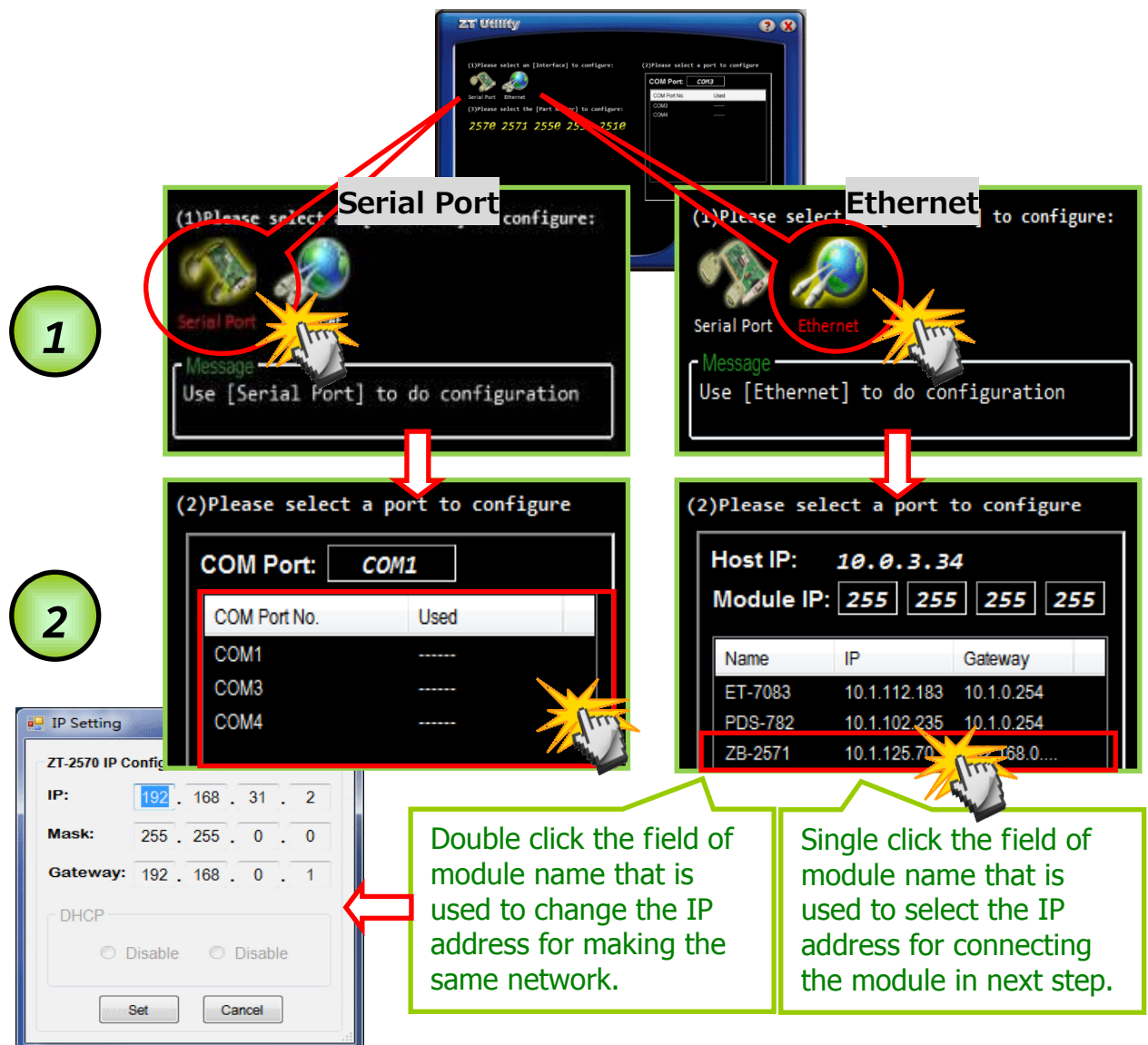

Step 3. After selecting the COM Port number, a list of model numbers will be displayed. Select the name of the module that you want to configure.

After clicking the button, the utility will begin checking the connection.

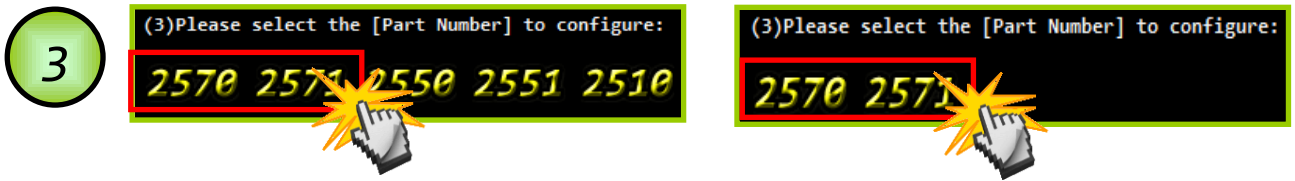

Step 4. Once a connection is established, select either the [Default] or the [Wizard] function from the settings mode page.



Step 5. Whether you select either the [Default] or the [Wizard] option for performing configuration, both are used to configure the Pan ID, Node ID, RF Channel, RF Power, Baud rate, Data Format, Application Mode and so the relevant parameters.



Please Configure the Argument of ZigBee

Part Number:	ZT-2571
FW Version of Device:	v00.10
Version of ZB-UP:	0250_v11

Pan ID:

Node ID:

RF Channel:

RF Power:



Please Select a Communication Interface to be enabled

- Serial Port (RS-232/RS-485)
- Ethernet
- Both of Serial Port and Ethernet
 - Server
 - Client
- Virtual COM



Please Configure the Argument of Serial Port

Baud Rate:

Data Bit:

Parity:

Stop Bit:



Please Configure the TCP Argument of ZT-257x

PC Side IP:	10	0	3	34
ZT-257x IP:	10	1	125	70
ZT-257x Mask:	255	255	0	0
ZT-257x Gateway:	192	168	0	254
ZT-257x Port:	502			

ZT-257x TCP Connection Argument (for Client Only)

Connection IP:	192	168	0	1
Connection Port:	502			



Application Mode

Transparent Addressable Modbus

Modbus



Step 6. Once the module configuration has been completed, the message "The Configuration was successful" will be displayed. Return the DIP switch to the "ZBRUN" position and reboot the ZT-257x device.



Message

Please confirm that you begin to set up

No Yes



Message

Please confirm that you wish to begin setup

No Home

Message

The Configuration was successful

4.4 Configure ZigBee via Browser (Ethernet)

Web Server technology enables configuration of the ZT-257x via a standard web browser interface, e.g. Internet Explorer, FireFox or Mozilla, etc. This means that it is easy to check the configuration of the ZT-257x via an Ethernet network without needing to install any other software tools, thereby reducing the user's learning curve.

Step 1. First, please confirm the desktop and ZT-257x is installed in the same network environment. The default network setting of ZT-257x as below.

ZT-257x device	
IP	192.168.255.1
Mask	255.255.0.0
Gateway	192.168.0.1

Step 2. User is able to query and modify the IP setting through via MiniOS utility and user may download the tool from the link:

http://ftp.icpdas.com/pub/cd/8000cd/napdos/minios7/utility/minios7_utility/

a. After launching the MiniOS utility, please press the "F12" on the keyboard to search the ZT-257x device.

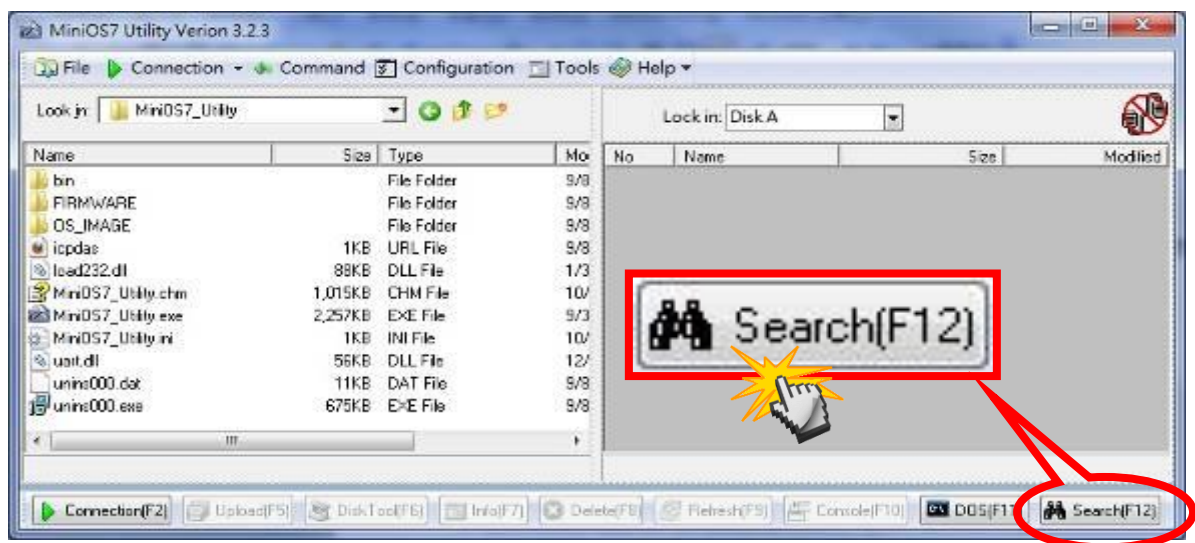

- b. After selecting the ZT-257x device, please click "IP setting" then it will show a windows form to do configuration.

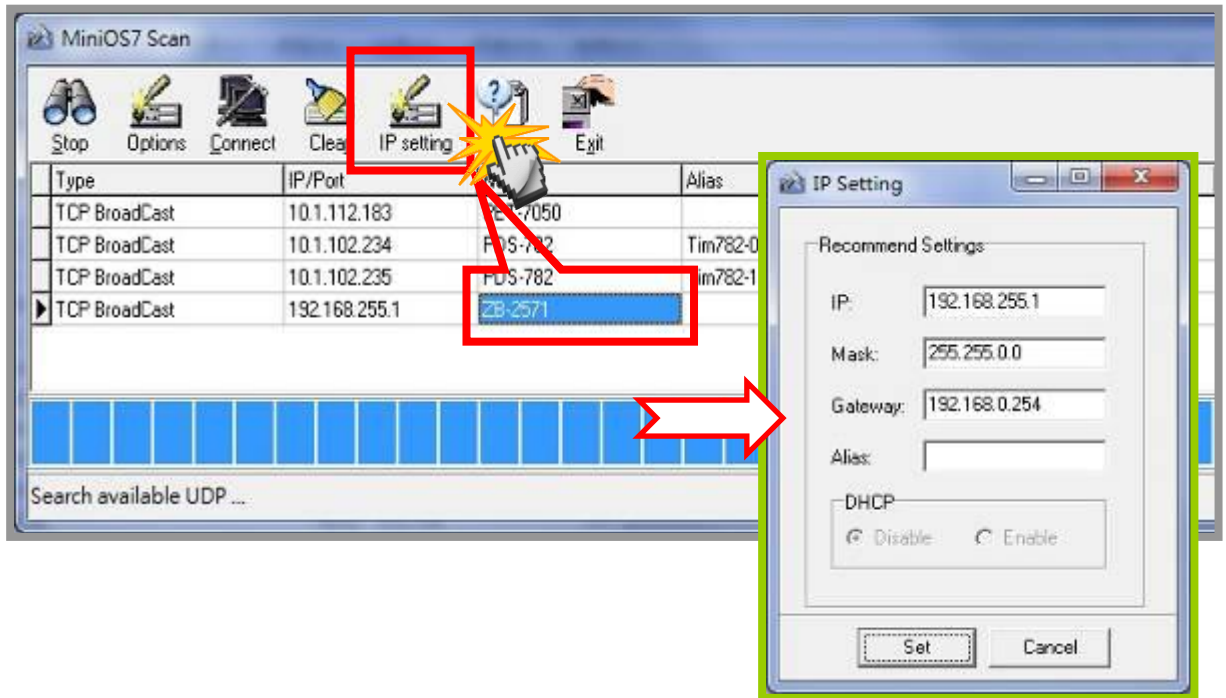

- c. Please configure the new IP setting which is the same segment to the LAN of desktop. Please also click the "Set" button to complete the configurations.

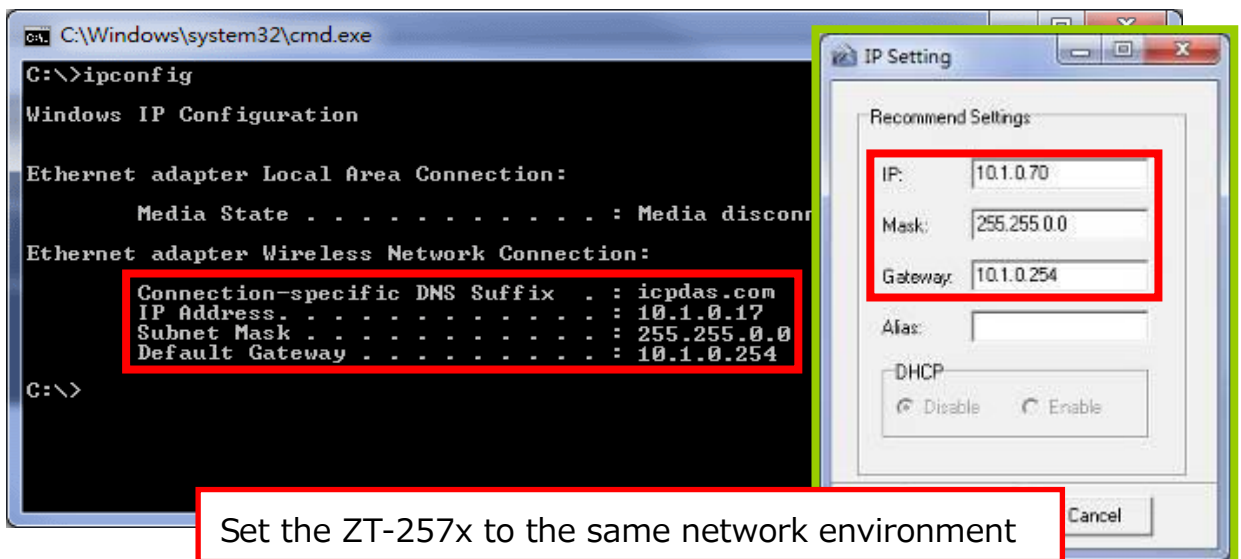

- d. After configuring the IP setting, you may try to PING the device to see whether the configuration is correct or not.

```
cmd
Microsoft Windows XP [Version 5.1.2600]
(C) Copyright 1995-2004 Microsoft Corp.
C:\WINDOWS>ping 10.1.0.70
Pinging 10.1.0.70 with 32 bytes of data:
Reply from 10.1.0.70 : bytes=32 time<1ms TTL=128
Reply from 10.1.0.70 : bytes=32 time<1ms TTL=128
Reply from 10.1.0.70 : bytes=32 time<1ms TTL=128
Reply from 10.1.0.70 : bytes=32 time<1ms TTL=128
Ping statistics for 10.1.0.70:
    Packets: Sent = 4, Received = 4, Lost = 0 (0% loss),
    Approximate round trip times in milliseconds:
    Minimum = 0ms, Maximum = 0ms, Average = 0ms
C:\WINDOWS>
```

Step 3. If they are in the same network environment, user can use a browser to set the configurations of ZT-257x. The site of ZT-257x device :

<http://10.1.0.70/index.htm>

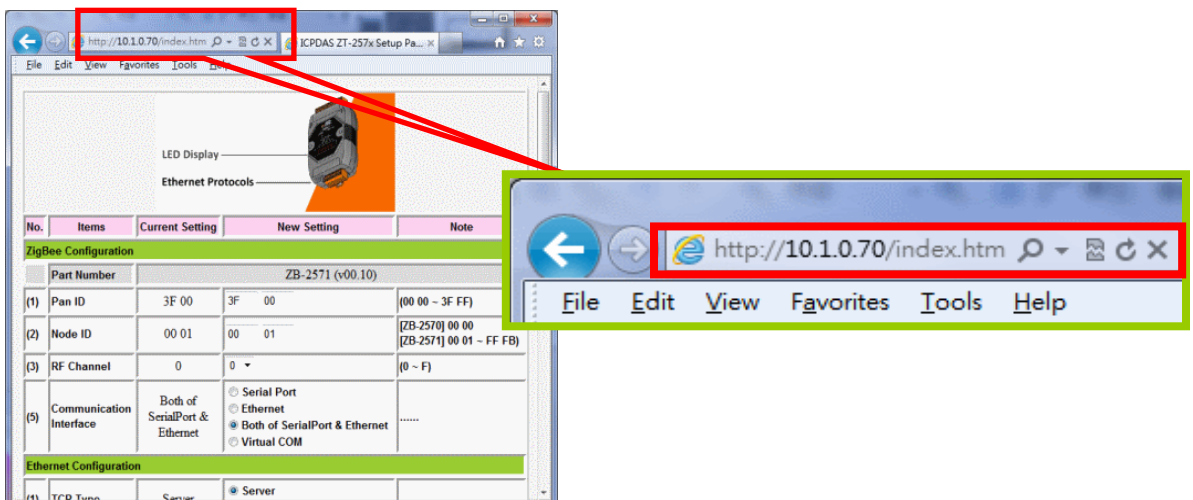

Step 4. When the browser access correctly, the web page will show all the configuration settings as below. User may enter the new setting value to the correct field if there are any requirements.

No.	Items	Current Setting	New Setting	Note
ZigBee Configuration				
	Part Number	ZB-2571 (v00.10)		
(1)	Pan ID	3F 00	3F 00	(00 00 ~ 3F FF)
(2)	Node ID	00 01	00 01	[ZB-2570] 00 00 [ZB-2571] 00 01 ~ FF FB)
(3)	RF Channel	0	0	(0 ~ F)
(5)	Communication Interface	Both of SerialPort & Ethernet	<input type="radio"/> Serial Port <input type="radio"/> Ethernet <input checked="" type="radio"/> Both of SerialPort & Ethernet <input type="radio"/> Virtual COM

Step 5. If the new configuration is completed, please click "Update New Config" button to start the ZT-257x configuration.

Serial Port Configuration				
(1)	Baud Rate	115200	115200	Default:115200 bps
(2)	Data Bit	8	8	Default:N,8,1 bps
(3)	Parity	None	None	
(4)	Stop Bit	1	1	
Application Mode				
(1)	Mode	Transparent	<input checked="" type="radio"/> Transparent <input type="radio"/> Addressable <input type="radio"/> Modbus
Default Config		Update New Config		

Step 6. When the configuration completed and successful, it will show ...

"The system is updated with new configurations!"

"Please reload the web page to see whether the configuration is correct or not"

then user may follow this instructions.

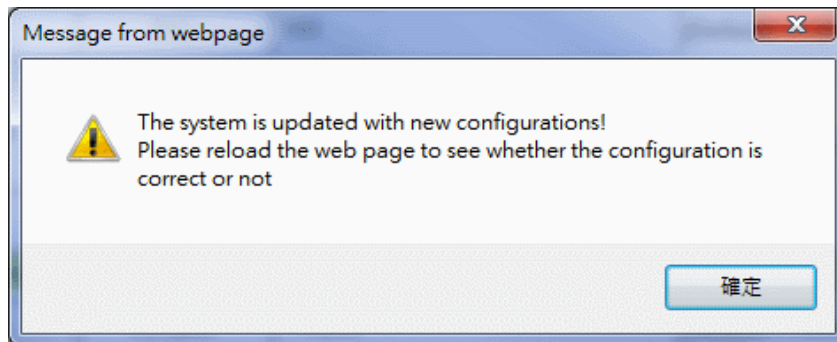

4.5 Configuration Example

The following configurations are common examples of various application scenarios. Please refer the "4.1 Introduction of Configurations" for detailed explanation of each configurations.

	ZT-2550 ZT-2570	ZT-20xx ZT-2551 ZT-2571	Note
Pan ID	00 00	00 00	Group identity should be the same
Node ID	00 00	00 01 ~ 3F FF	Node identity cannot be repeated
RF Channel	E	E	Radio frequency should be the same
RS-232/RS-485			
Baud Rate Data Format Receive Interval	115200 N,8,1 3.5 character time	9600 E,8,1 3.5 character time	※ User-configurable The wired-communication are independent to each ZT devices, so the baud rate and data format are also independent on both side
Ethernet			
Server/Client	TCP Server	TCP Client	
IP Port	10.1.0.70 502	192.168.0.70 502	※ User-configurable The wired-communication are independent to each ZT devices, so the ZT-2570 and ZT-2571 are not in the same LAN.

<Reminding >

Please confirm the TCP client is disabled if there is not any TCP server connected – otherwise the ZT device will try to establish TCP connection continuously, which results the communication blocking.

4.5.1. Transparent Data Transmission



Application Mode

Transparent Mode is suitable for most applications in the transparent data transmission. In this mode, the raw data transmitted from ZigBee coordinator will be broadcasting to every ZigBee routers. The data responded by ZigBee router will only be sent to ZigBee coordinator via unicasting.

Unless there are particular purposes, Transparent Mode can be set-up in most applications. The only drawback is that the data throughput of ZigBee network will be reduced with the number of ZigBee routers in the ZigBee network increased, in order to ensure data transmitted to every ZigBee nodes so that the transfer time will be much longer than using unicast frame.

	ZT-2550 ZT-2570	ZT-2551 ZT-2571	備註
Application Mode	Transparent	Transparent	Not any special limitation

4.5.2. Modbus RTU communication

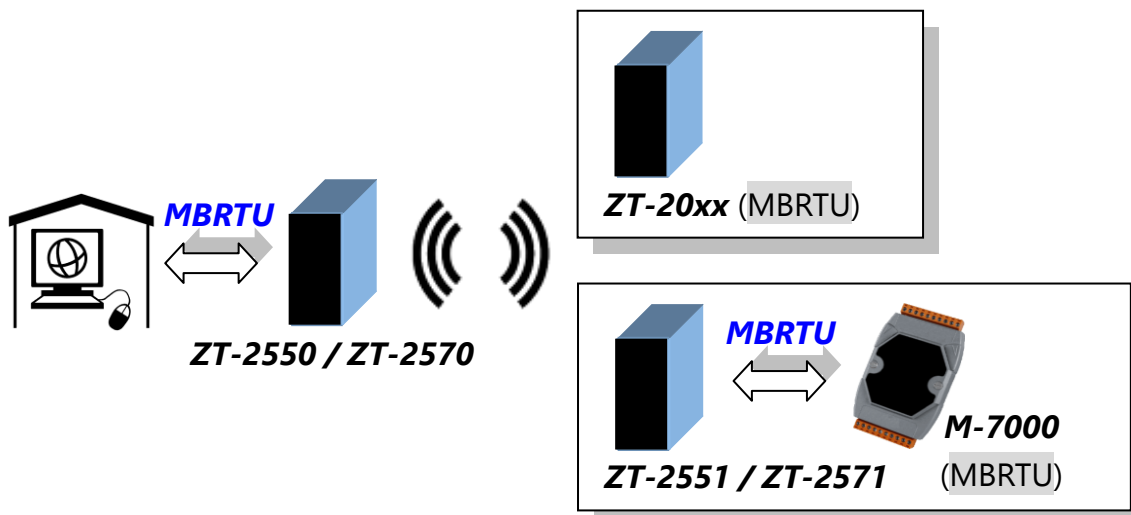

Application Mode

Transparent Mode and Gateway Mode are available to be used in Modbus RTU data transmission. The only difference is that the two modes use different type transmission packets.

In Transparent Mode, the benefit of broadcasting is easy to use, there is not any particular limitation to use this application mode. The only drawback is that the data throughput of ZigBee network will be reduced with the number of ZigBee routers in the ZigBee network increased, in order to ensure data transmitted to every ZigBee nodes so that the transfer time will be much longer than using unicast frame.

In Gateway Mode, the benefit of unicasting is that the loading of ZigBee network will be reduced. But there are some issues need to be considered, please refer the 【Advanced Configuration - Frame Type】 for more details as below.

	ZT-2550 ZT-2570	ZT-2551 ZT-2571	備註
Application Mode	Transparent	Transparent	Not any special limitation
	Gateway	Gateway	Refer 【Advanced Configuration - Frame Type】

【Advanced Configuration - Frame Type】

1. The unicast frame is the default setting of Gateway Mode which is used for the wireless transmission. In this setting, the Node ID and Address of Modbus RTU device should be set to the same. Please refer the following examples.
 - *The Modbus RTU device of address 0x01 is only able to be connected with the ZT-2551/71 of Node ID 0x0001.*
 - *The Modbus RTU device of address 0x02 is only able to be connected with the ZT-2551/71 of Node ID 0x0002. ... and so on*

2. If there are two or more Modbus RTU devices should be connected with a single ZT-2551/71, there are two methods can be referred as below.
 - *Change the frame type of ZT-2550/70 to the broadcast mode in the advanced configuration.*
 - *Set-up the Address Mapping in the ZT-2550/70 which is used to redirect the unicast frame to the corresponding ZT-2551/71 device. Please refer the section of "[7.2 DCON/MODBUS Device Communication](#)" for more details.*

4.5.3. Modbus RTU to Modbus TCP communication

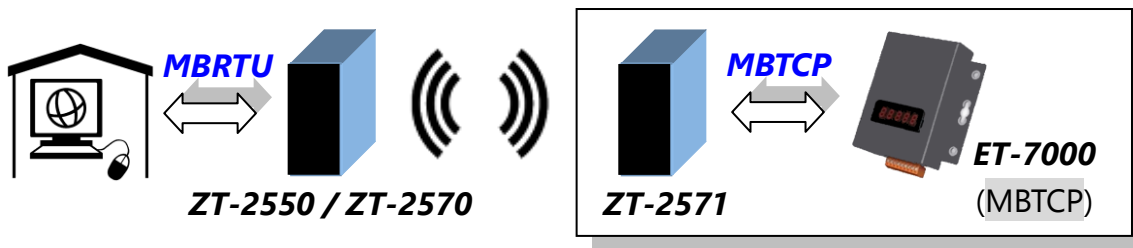

Application Mode of ZT-2550/ZT-2570

Transparent Mode and Gateway Mode are available to be used in the side of ZigBee coordinator. The only difference is that the two modes use different type transmission packets.

In Transparent Mode, the benefit of broadcasting is easy to use, there is not any particular limitation to use this application mode. The only drawback is that the data throughput of ZigBee network will be reduced with the number of ZigBee routers in the ZigBee network increased, in order to ensure data transmitted to every ZigBee nodes so that the transfer time will be much longer than using unicast frame.

In Gateway Mode, the benefit of unicasting is that the loading of ZigBee network will be reduced. But there are some issues need to be considered, please refer the **【Advanced Configuration - Frame Type】** for more details as below.

Application Mode of ZT-2571

Gateway Mode is required to be set-up, it is responsible for the data conversion between the Modbus RTU and Modbus TCP.

	ZT-2550 ZT-2570	ZT-2571	備註
Application Mode	Transparent		Not any special limitation
	Gateway	Gateway	Refer 【Advanced Configuration - Frame Type】

【Advanced Configuration - Frame Type】

1. The unicast frame is the default setting of Gateway Mode which is used for the wireless transmission. In this setting, the Node ID and Address of Modbus TCP device should be set to the same. Please refer the following examples.

- *The Modbus TCP device of address 0x01 is only able to be connected with the ZT-2571 of Node ID 0x0001.*
- *The Modbus TCP device of address 0x02 is only able to be connected with the ZT-2571 of Node ID 0x0002. ... and so on*

4.5.4. Modbus TCP communication

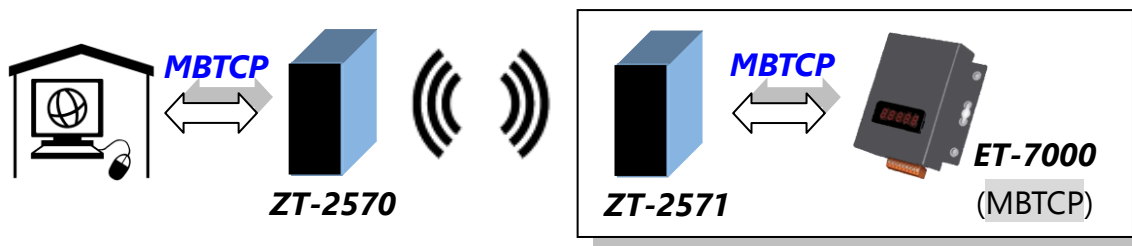

Application Mode

Transparent Mode and Gateway Mode are available to be used in the side of ZigBee coordinator. The only difference is that the two modes use different type transmission packets.

In Transparent Mode, the benefit of broadcasting is easy to use, there is not any particular limitation to use this application mode. The only drawback is that the data throughput of ZigBee network will be reduced with the number of ZigBee routers in the ZigBee network increased, in order to ensure data transmitted to every ZigBee nodes so that the transfer time will be much longer than using unicast frame.

In Gateway Mode, the benefit of unicasting is that the loading of ZigBee network will be reduced. But there are some issues need to be considered, please refer the **【Advanced Configuration - Frame Type】** for more details as below.

	ZT-2570	ZT-2571	備註
Application Mode	Transparent	Transparent	Refer 【Ethernet Connection】
	Gateway	Gateway	Refer 【Advanced Configuration - Frame Type】 and 【Ethernet Connection】

【Advanced Configuration - Frame Type】

1. The unicast frame is the default setting of Gateway Mode which is used for the wireless transmission. In this setting, the Node ID and Address of

Modbus TCP device should be set to the same. Please refer the following

examples.

- The Modbus TCP device of address 0x01 is only able to be connected with the ZT-2571 of Node ID 0x0001.
- The Modbus TCP device of address 0x02 is only able to be connected with the ZT-2571 of Node ID 0x0002. ... and so on

【Ethernet Connection】

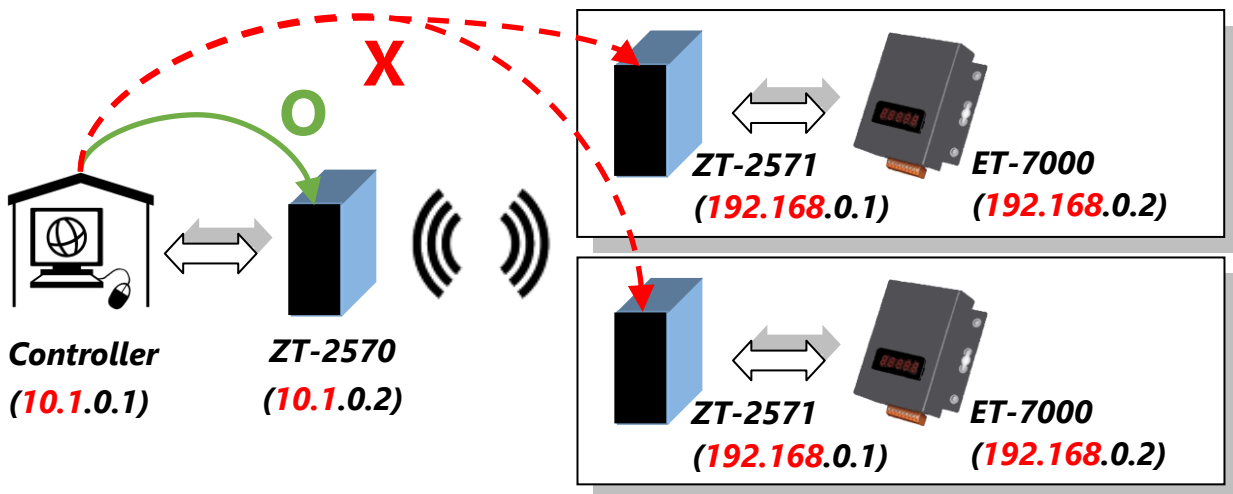

1. When the ZT-2571 acts the TCP client, there is only one Modbus TCP device can be connected to the ZT-2571.
 - Such as the ZT-2571 acts TCP client to connect with the ET-7000.
2. The standard of ZigBee does not include the TCP/IP protocol, so the whole Ethernet packets cannot be sent over the ZigBee wireless communication. In the other words, the two separate local area network will not be linked together into one LAN via the ZigBee wireless communication.
 - As the described above, the LANs of ZT-2570 and ZT-2571 are independent. So, no matter which Modbus TCP devices you want to connect, all the connection target should be changed to the IP address of ZT-2570.
 - In the origin architecture, the Modbus TCP devices are distinguished via

connecting the different IP addresses. However, now all the socket connections are linked to the ZT-2570, so please use the Modbus Address to distinguish the distinct Modbus TCP devices.

4.5.5. Modbus TCP to Modbus RTU communication

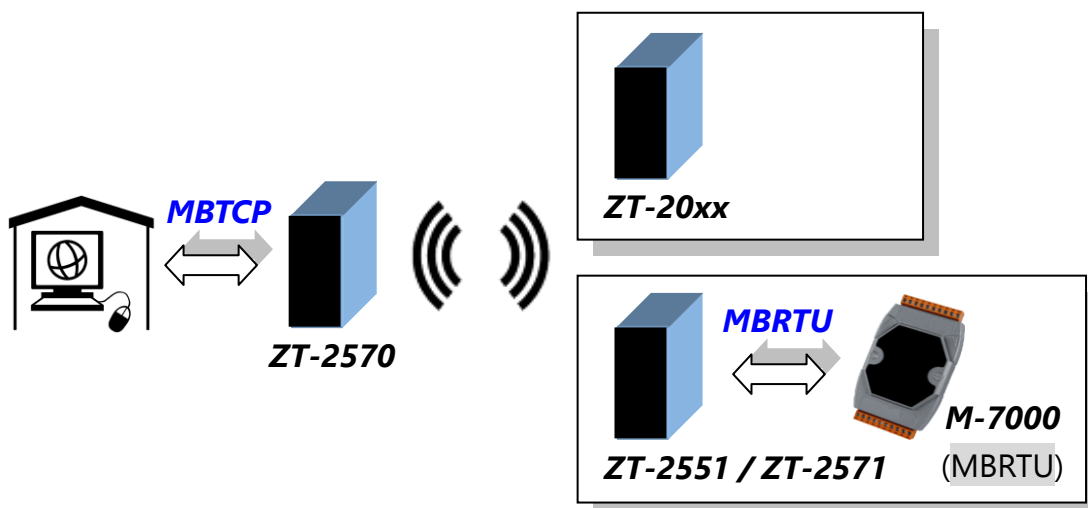

Application Mode of ZT-2570

Gateway Mode is required to be set-up in the side of ZigBee coordinator, it is responsible for the data conversion between the Modbus TCP and Modbus RTU. There are some issues need to be considered, please refer the 【Advanced Configuration - Frame Type】 for more details as below.

Application Mode of ZT-2551/ZT-2571

Transparent Mode and Gateway Mode are available to be used in the side of ZigBee router. There are not any different to be used, the data responded by ZigBee router will only be sent to ZigBee coordinator via unicasting.

	ZT-2570	ZT-2551 ZT-2571	備註
Application Mode	Gateway	Transparent Gateway	Refer 【Advanced Configuration - Frame Type】 and 【Ethernet Connection】

【Advanced Configuration - Frame Type】

1. The unicast frame is the default setting of Gateway Mode which is used for the wireless transmission. In this setting, the Node ID and Address of Modbus RTU device should be set to the same. Please refer the following

examples.

- The Modbus RTU device of address 0x01 is only able to be connected with the ZT-2551/71 of Node ID 0x0001.
- The Modbus RTU device of address 0x02 is only able to be connected with the ZT-2551/71 of Node ID 0x0002. ... and so on

2. If there are two or more Modbus RTU devices should be connected with a single ZT-2551/71, there are two methods can be referred as below.

- Change the frame type of ZT-2550/70 to the broadcast mode in the advanced configuration.
- Set-up the Address Mapping to redirect the unicast frame to the corresponding ZT-2551/71 device. Please refer the section of "[7.2 DCON/MODBUS Device Communication](#)" for more details.

【Ethernet Connection】

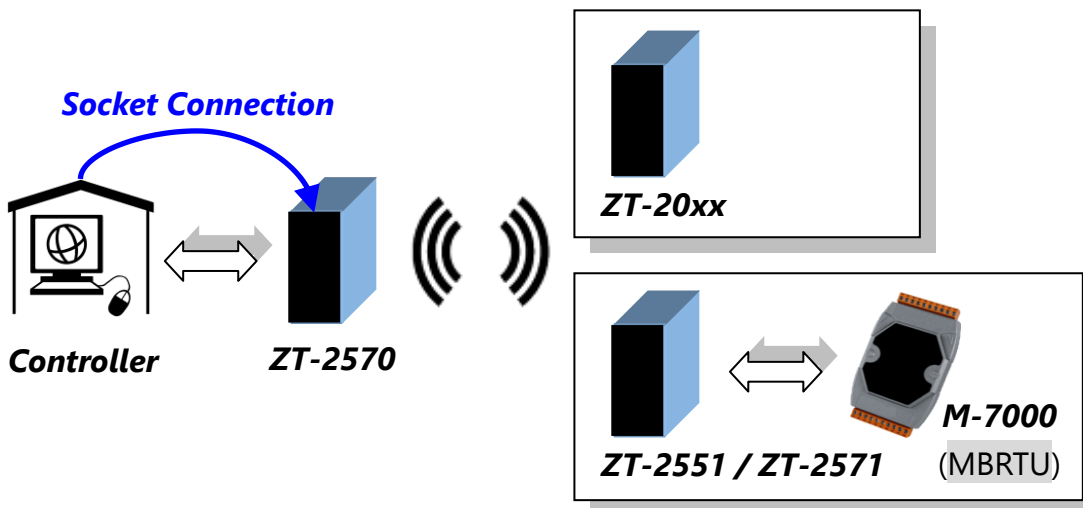

1. The standard of ZigBee does not include the TCP/IP protocol, so the whole Ethernet packets cannot be sent over the ZigBee wireless communication. In the other words, there is only raw data of Ethernet packets will be sent to

remote Modbus RTU devices.

- *ZT-2570 is an Ethernet gateway to convert the signal between Ethernet and ZigBee. All the Modbus communication are completed via the socket connection between the controller and ZT-2570.*
- *Although all the Modbus TCP data should be transmitted via the IP address of ZT-2570, but the Modbus Address still can be used to distinguish the distinct Modbus TCP devices.*

4.5.6. Both Modbus RTU & TCP communication

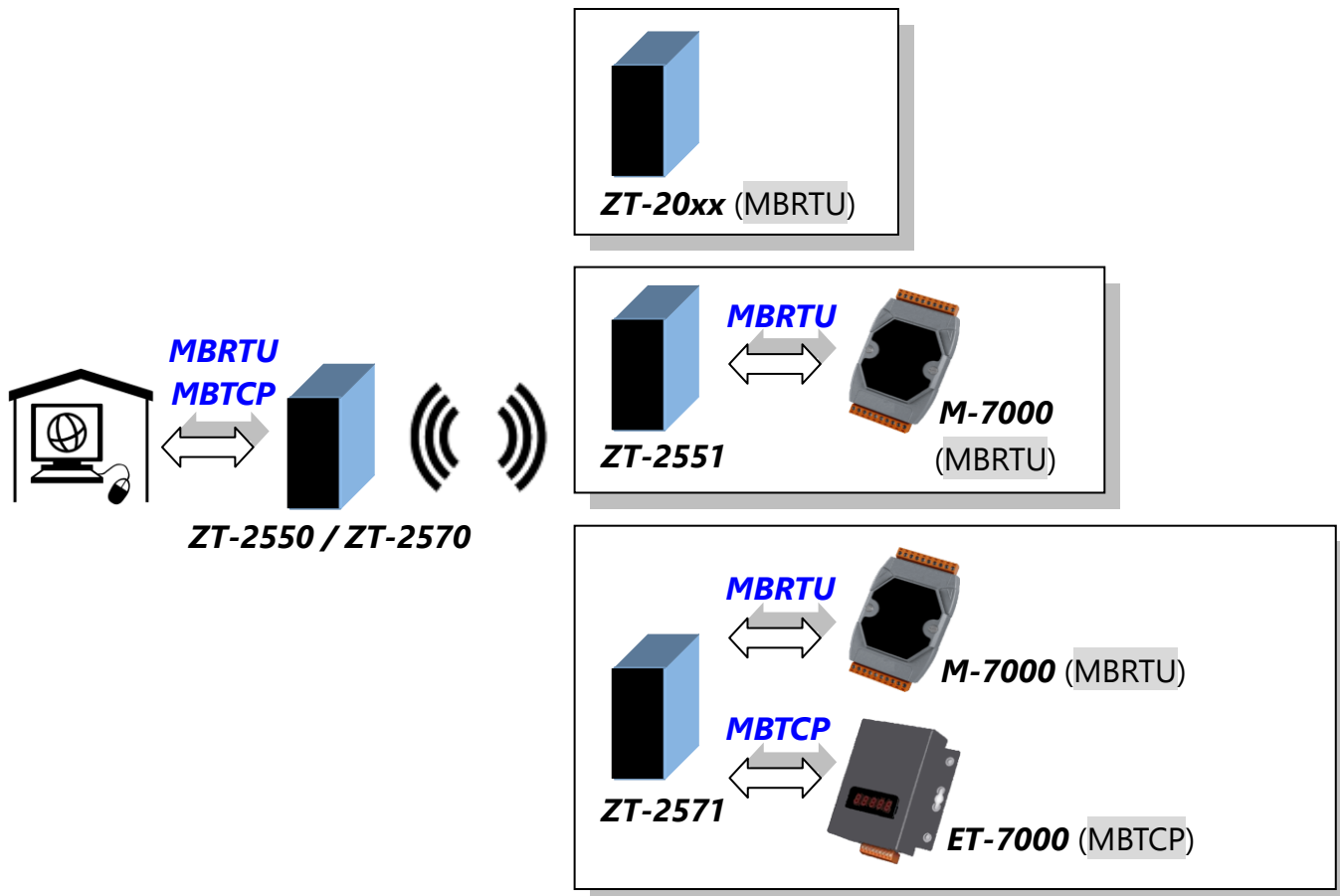

Application Mode

Gateway Mode is required to be set-up in both side of ZigBee coordinator and ZigBee router, it is responsible for the data conversion between the Modbus TCP and Modbus RTU. There are some issues need to be considered, please refer the **【Advanced Configuration - Frame Type】** for more details as below.

	ZT-2550 ZT-2570	ZT-2551 ZT-2571	備註
Application Mode	Gateway	Gateway	Refer 【Advanced Configuration - Frame Type】 and 【Ethernet Connection】

【Advanced Configuration - Frame Type】

1. The unicast frame is the default setting of Gateway Mode which is used for the wireless transmission. In this setting, the Node ID and Address of

Modbus RTU/TCP device should be set to the same. Please refer the following examples.

- The Modbus RTU/TCP device of address 0x01 is only able to be connected with the ZT-2551/71 of Node ID 0x0001.
- The Modbus RTU/TCP device of address 0x02 is only able to be connected with the ZT-2551/71 of Node ID 0x0002. ... and so on

2. If there are two or more Modbus RTU devices should be connected with a single ZT-2551/71, there are two methods can be referred as below.

- Change the frame type of ZT-2550/70 to the broadcast mode in the advanced configuration.
- Set-up the Address Mapping in the ZT-2550/70 which is used to redirect the unicast frame to the corresponding ZT-2551/71 device. Please refer the section of "[7.2 DCON/MODBUS Device Communication](#)" for more details.

[Ethernet Connection]

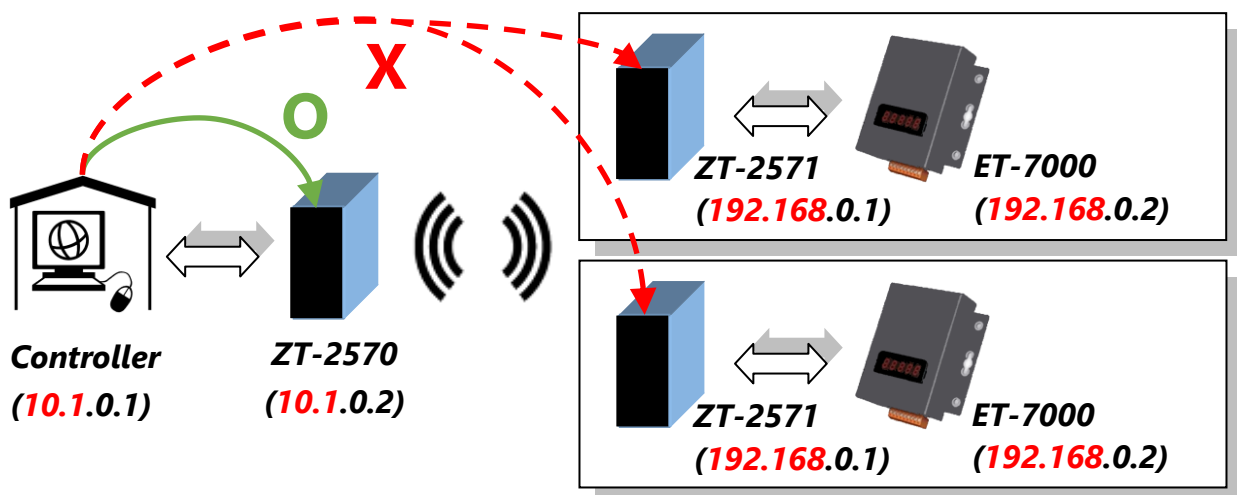

1. When the ZT-2571 acts the TCP client, there is only one Modbus TCP device can be connected to the ZT-2571.

- Such as the ZT-2571 acts TCP client to connect with the ET-7000.

2. The standard of ZigBee does not include the TCP/IP protocol, so the whole Ethernet packets cannot be sent over the ZigBee wireless communication. In the other words, the two separate local area network will not be linked together into one LAN via the ZigBee wireless communication.
 - *As the described above, the LANs of ZT-2570 and ZT-2571 are independent. So, no matter which Modbus TCP devices you want to connect, all the connection target should be changed to the IP address of ZT-2570.*
 - *In the origin architecture, the Modbus TCP devices are distinguished via connecting the different IP addresses. However, now all the socket connections are linked to the ZT-2570, so please use the Modbus Address to distinguish the distinct Modbus TCP devices.*

4.6 Test Communications

When all the configuration set-up completed, please turn the DIP switch to "ZBRUN" position and reboot module.

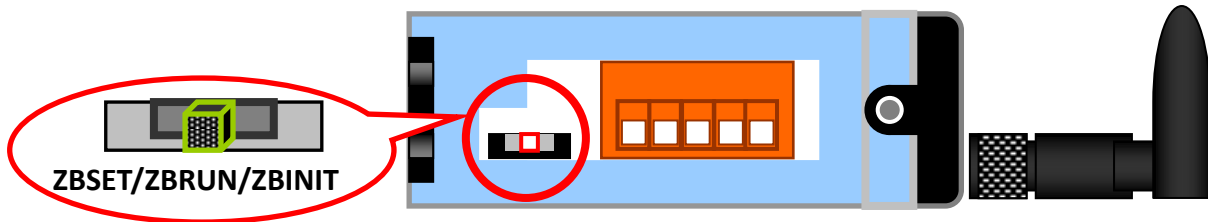

Next, please confirm the "ZB Net" LED indicator of ZigBee salves whether is steady lighted or not. If the status of green LED indicator is steady lighted, it means the connection has established and user can start using Ethernet or serial port to do communication.

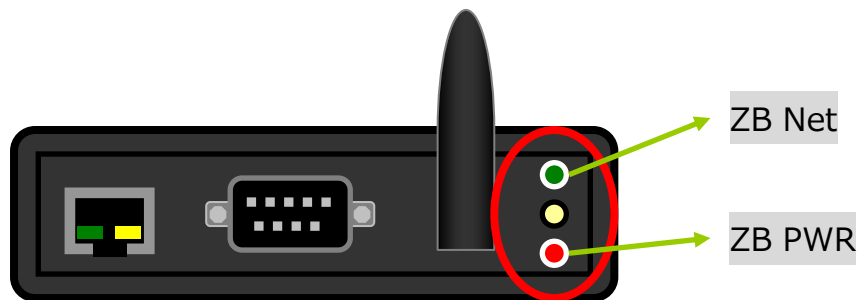

A. Serial Port Test

Method (1)

Connect both the ZT-2570 and ZT-2571 to the Host PC via the RS-232 port. You may need to use two serial port tools to simulate the data transmission.

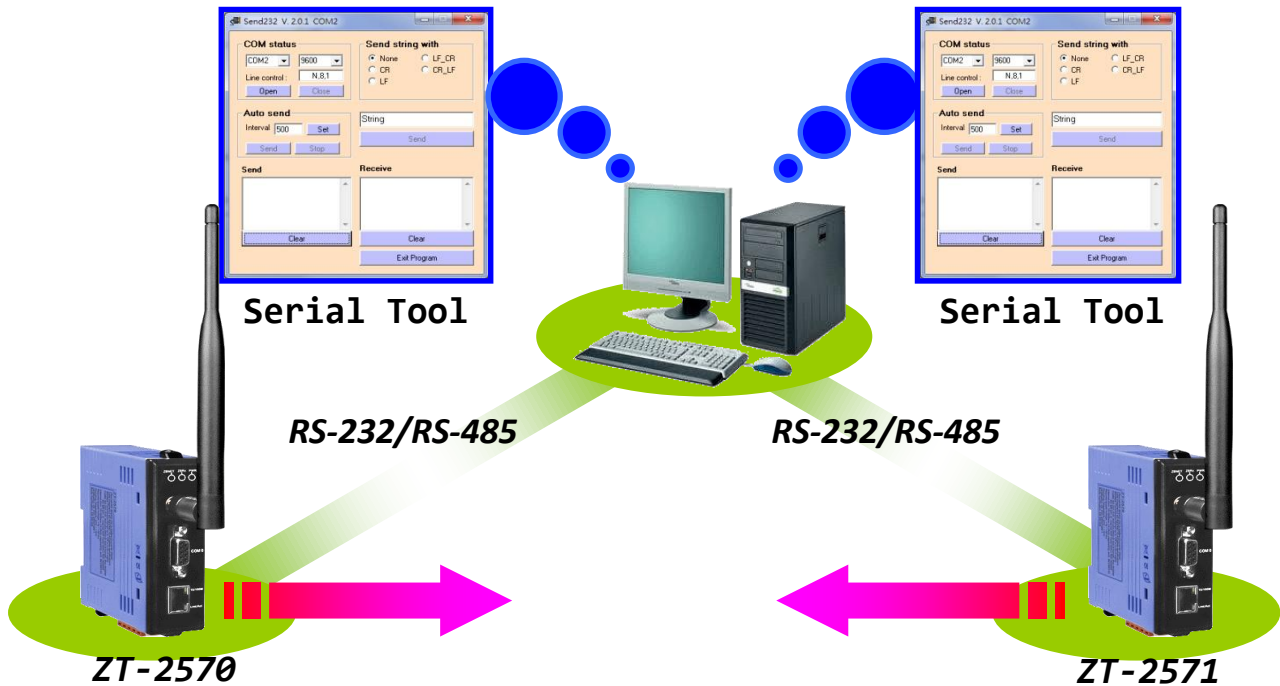

Method (2) :

Use the DCON Utility on the Host PC to search for ZT-2000 series I/O modules. If there any devices are found, it means that the configuration is correct.

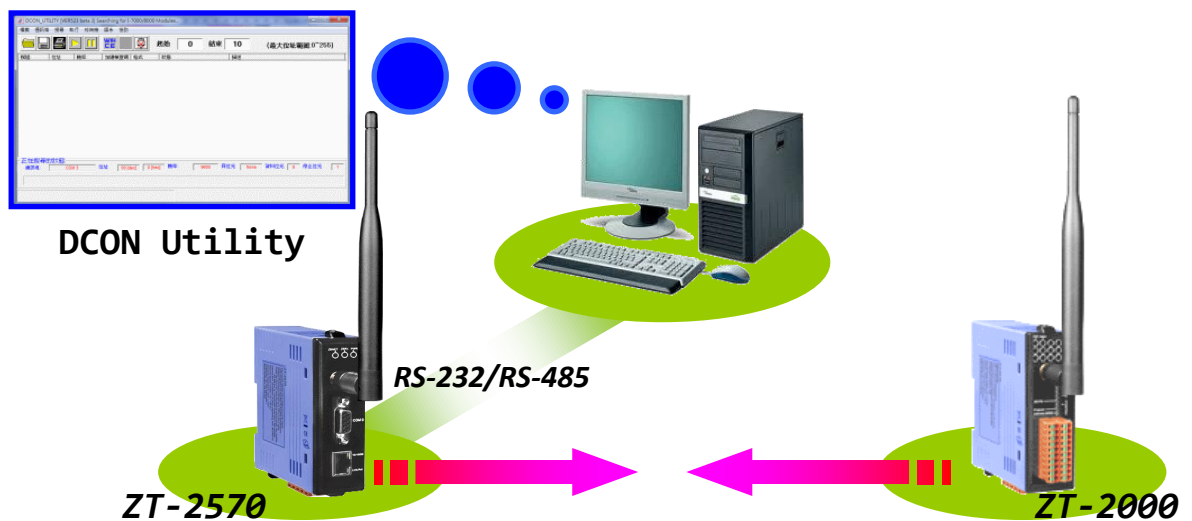

※ Download MiniOS Utility :

http://ftp.icpdas.com/pub/cd/8000cd/napdos/minios7/utility/minios7_utility/

※ If there is not any serial tool can be used, please use "Send232.exe" which is a serial tool at the directory : \ICPDAS\MiniOS7_Utility\bin\Send232.exe

B. Ethernet Test

Method(1) :

Connect both the ZT-2570 and ZT-2571 to the Host PC via the Ethernet port. You may need to use two TCP Server/Client tools to simulate the data transmission.

Method(2) :

Use the EZ-Data Logger as a TCP Client which is connected to the ZT-2570 on the Host PC to search for ZT-2000 series I/O modules. If there any devices are found, it means that the configuration is correct.

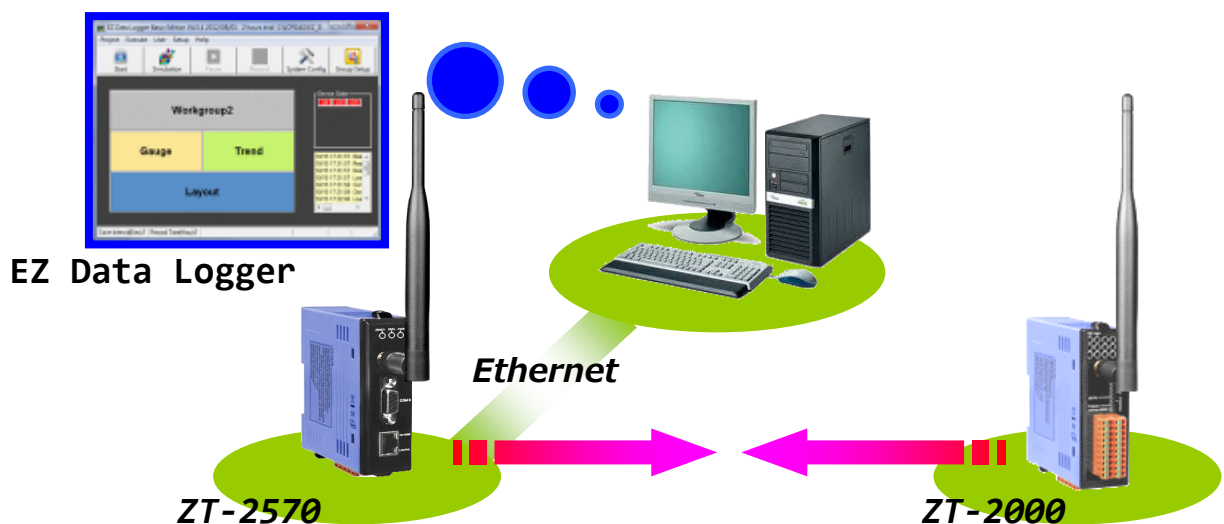

5 Applications

(1) ZT-257x is suitable for using in which is wiring difficult and low data rate environment.

- Eg. The I/O nodes are across to the road, building, gutter or etc.

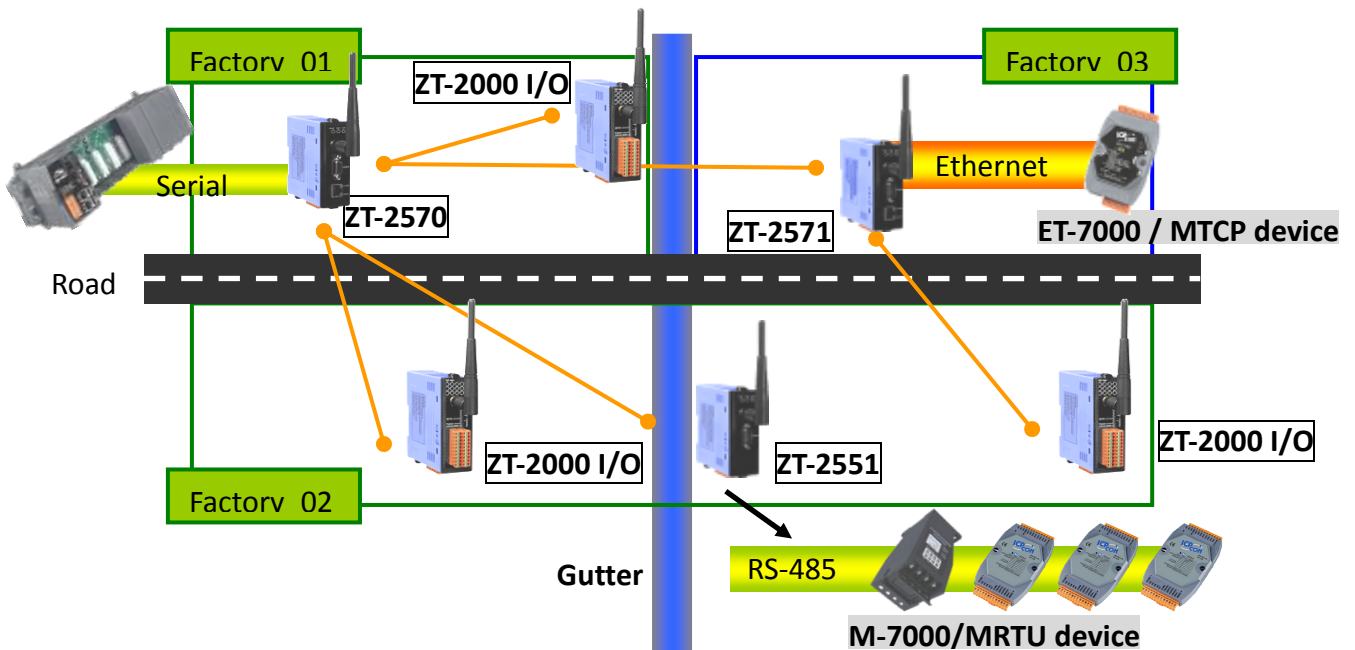

(2) ZT-257x is suitable to use in monitoring and controlling.

- Eg. Smart energy, Home automation and etc.

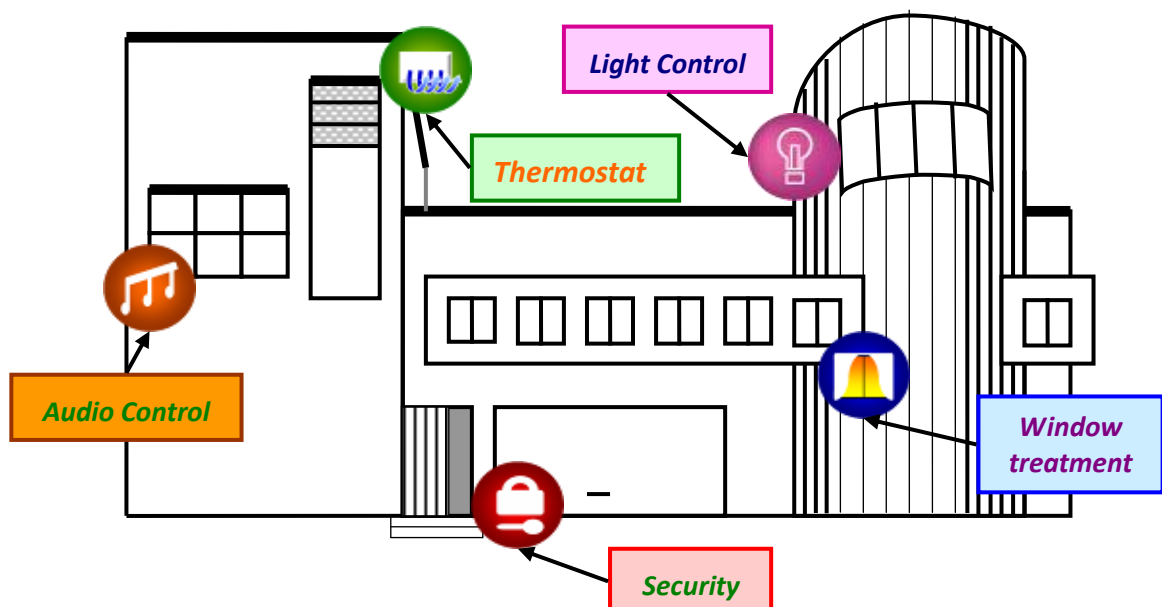

6 *Trouble shooting*

6.1 Technical Support

If you have any difficulties using your ZT-257x series module, please send a description of the problem to service@icpdas.com

Include the following items in your email:

- *A description to the communication protocol for more information.*
- *A copy of the configuration file for the ZT-257x module. This file can be obtained using the procedure outlined below and should be attached to your email.*

Step 1. Set the DIP switch of the ZT-257x device to the [ZBSET] position then reboot the device. Launch the ZT Configuration Utility and select [Save Log] icon to save the configuration of the ZT-257x as a file.



Step 2. After clicking the [Save Log] icon, enter the "File Name" and the "File Path" in the Windows "Save" dialog box. Once the configuration has been successfully saved, the following message will be displayed.

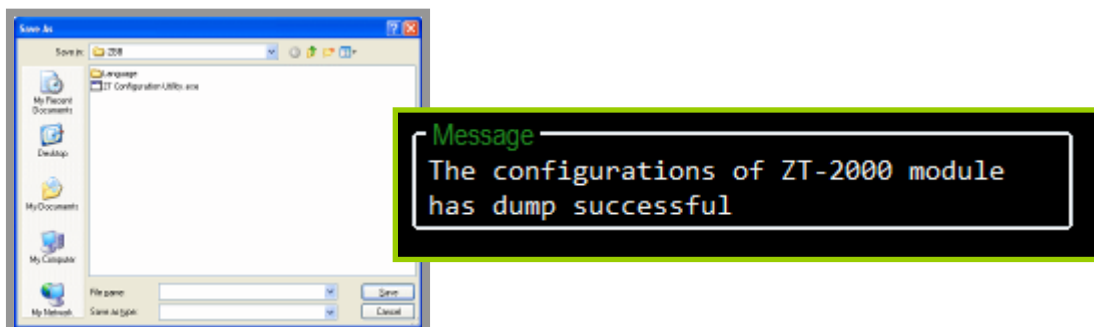

7 *Appendixes*

7.1 LED Indicator Status

LED Indicator	Status	Introduction
ZigBee Net (Green LED)	ZigBee Coordinator (Host)	
	Steady Lit	ZigBee network is Establish
	Blink to Steady Lit	Rejoin ZigBee Network or It has Occupied
	ZigBee Router (Slave)	
	Steady Lit	The Signal is Strong
	Blinking (500 ms)	The Signal is Available
	Blinking (1s)	The Signal is Weak
	Blinking (2s)	The Signal is Unstable or There is no Available
ZigBee RxD (Yellow LED)	The status of ZigBee communication	
	Blinking	Receiving ZigBee Data
	Steady Unlit	No ZigBee Data Received
ZigBee PWR (Red LED)	The status of module board	
	Steady Lit	Power ON
	Blinking (200ms)	Module Initialization Failure
	Blinking (200ms)	Configuration Mode
	Blinking (1s)	Watchdog Enabled
	Steady Unlit	Power OFF

7.2 DCON/MODBUS Device Communication

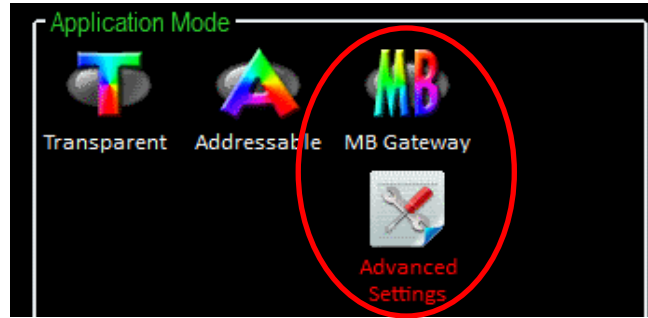

ZigBee is defined as a low-power and low data rate wireless transmission protocol. In order to prevent excessive transmission loading to the ZigBee network, there is an advanced setting to the Gateway Mode to set the wireless frame type, which is used to select either the Broadcast Frame or Unicast Frame to transmit data.

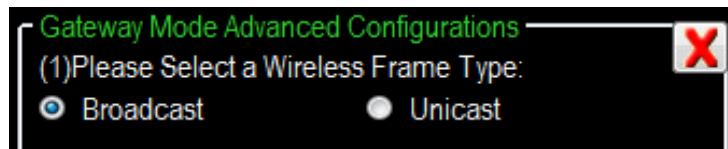

Once the Unicast Frame is selected, the Address of DCON or Modbus instructions will be regarded as the destination address to the ZigBee. So, the DCON/Modbus devices should be connected to corresponding address of ZigBee module.

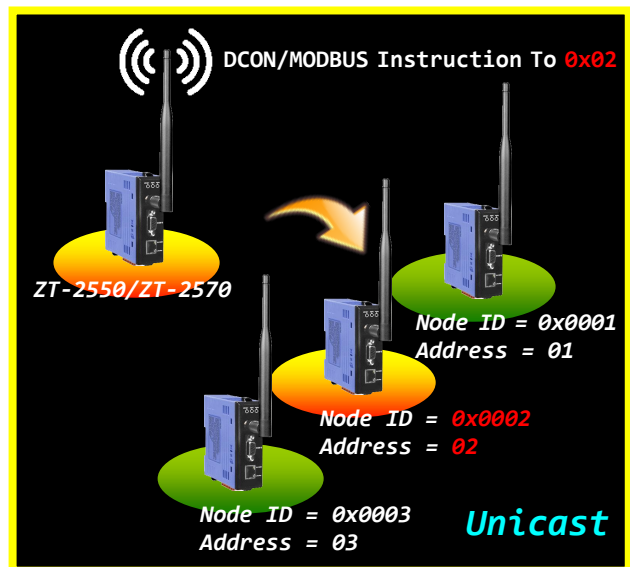
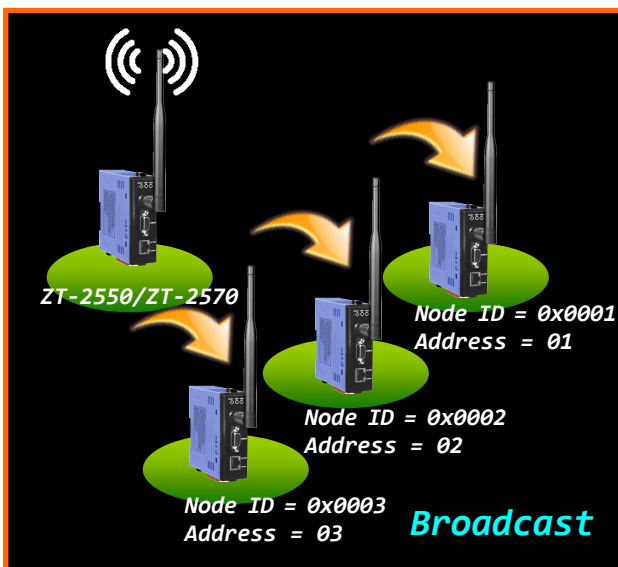

For some applications, there are several DCON or Modbus devices should be connected to the same ZT-2551 or ZT-2571 module.

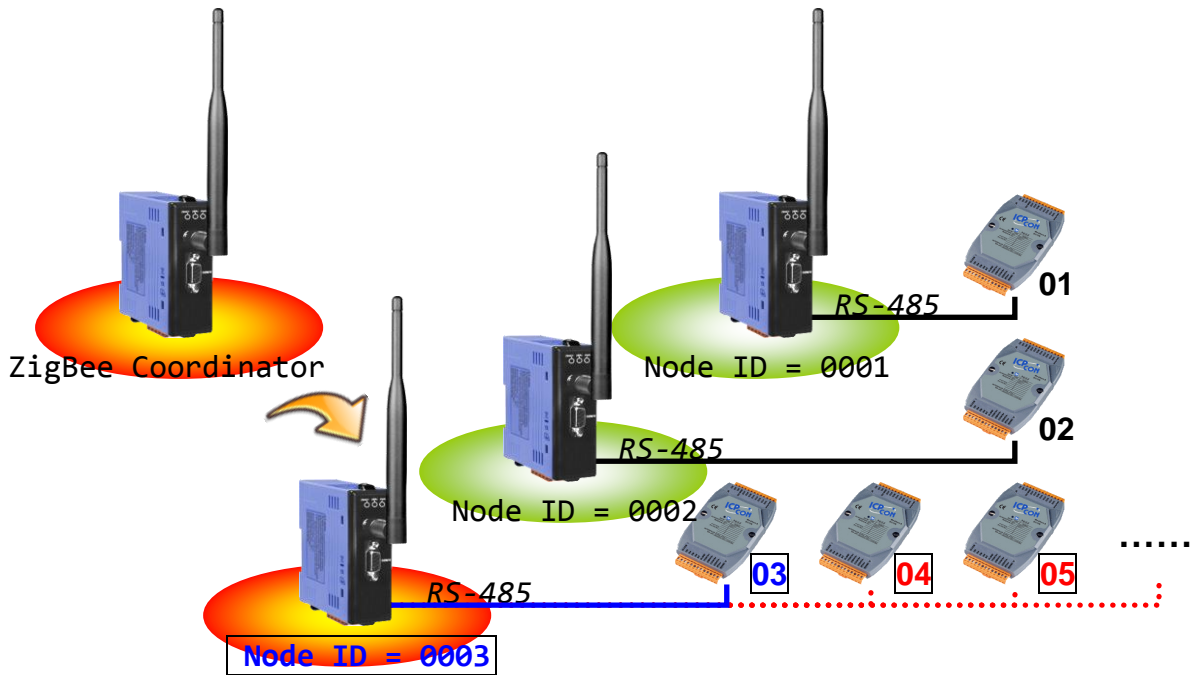

Although the addresses of these additional DCON and Modbus devices are not corresponding to the relative ZigBee module, but there is an Address Mapping function supported for redirection to the correct destination address of ZigBee module. User only fills in the relationship of address mapping for redirection via the ZT-2000 Configuration Utility.

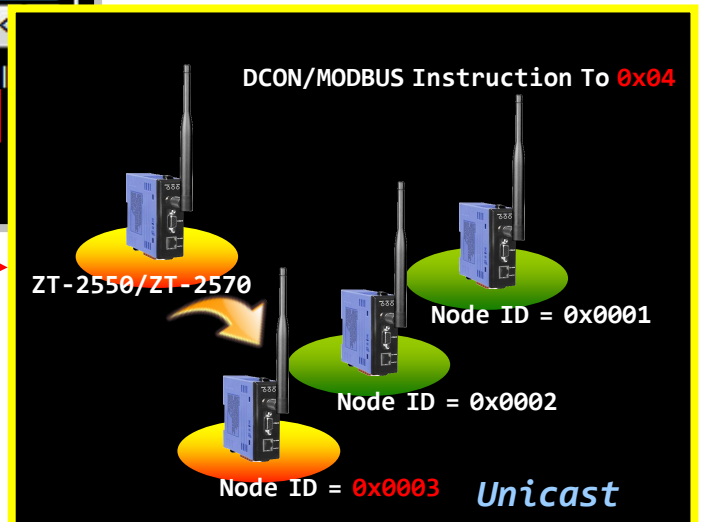
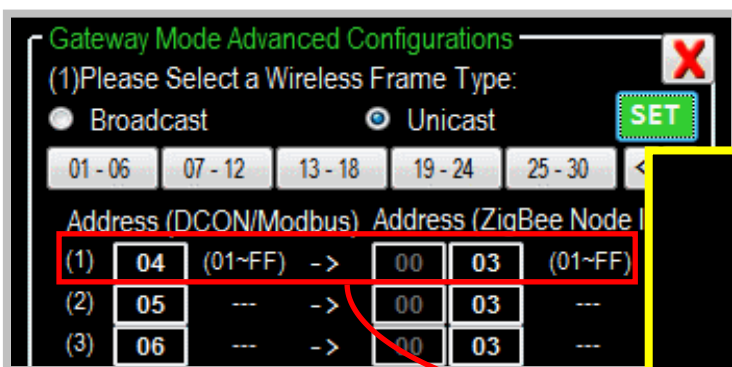

7.3 Non-addressable Device Communication

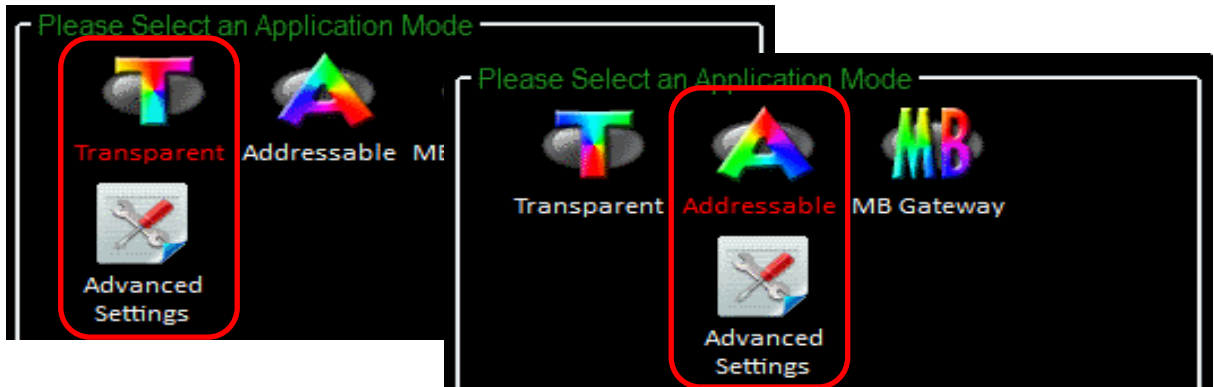

In some applications, there are some devices can not be addressable and they even take the initiative to reply data. Once these non-addressable devices send data to the user's controller via ZigBee, the user program can not identify which device sends this data.

For example, there are several barcode readers and RS-232 device connected to the ZT-2551. Once these devices are triggered to reply data, the controller will not be able to identify which end device sends the data.

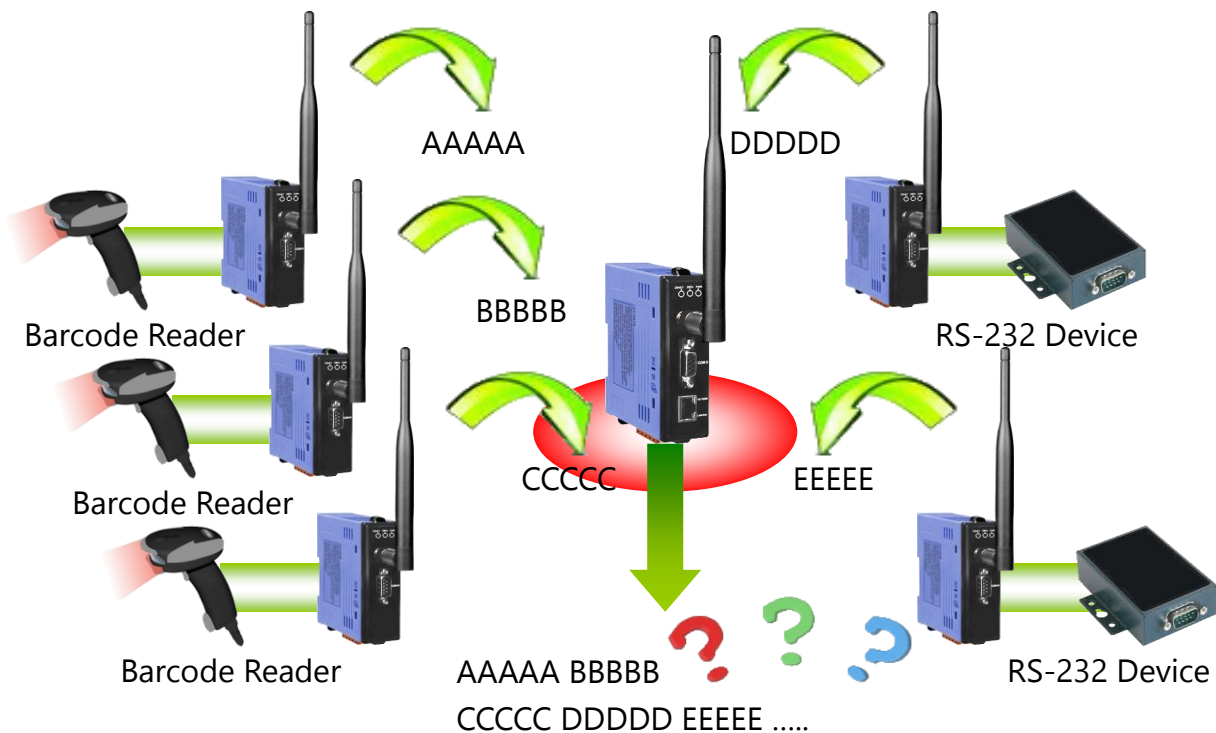

In order to provide a solution for the similar application using non-addressable device, there is an advanced setting to the Transparent Mode and Addressable Mode to show the Node ID of the remote ZigBee device which is connected to the user's end-device.

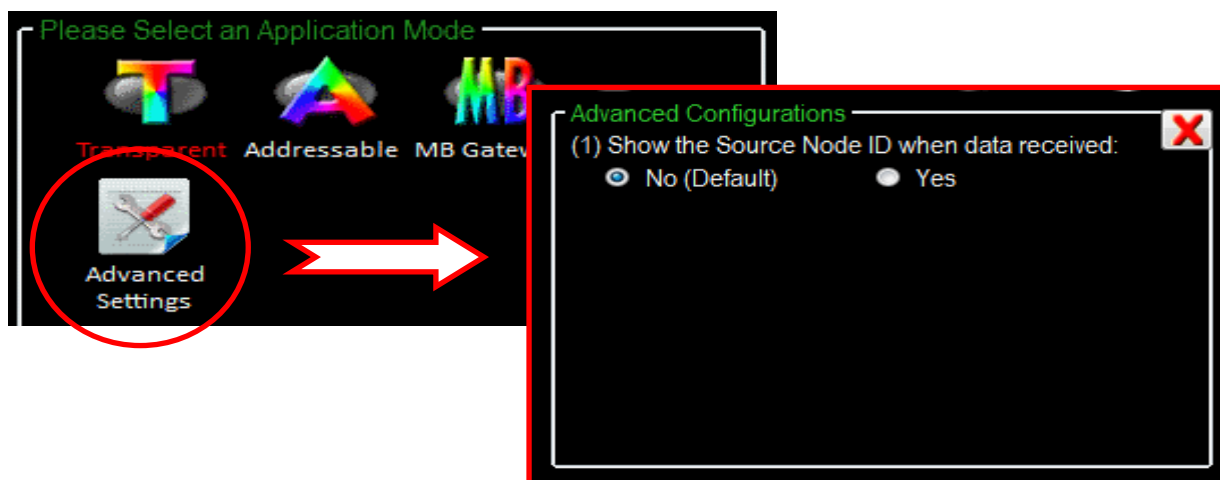

When the advanced function is enabled, the Node ID will be added in the “:AAAA” format in front of the original data and then be output once receiving remote data.

