

# SMS-530

## Intelligent 3G SMS Alarm Controller

User's Manual V1.1



High Quality, Industrial Data Acquisition, and Control Products

## Warranty

---

All products manufactured by ICP DAS are warranted against defective materials for a period of one year from the date of delivery to the original purchaser.

## Warning

---

ICP DAS assumes no liability for damages consequent to the use of this product. ICP DAS reserves the right to change this manual at any time without notice. The information furnished by ICP DAS is believed to be accurate and reliable. However, no responsibility is assumed by ICP DAS for its use, or for any infringements of patents or other rights of third parties resulting from its use.

## Copyright

---

Copyright 2014 by ICP DAS CO., LTD. All rights reserved worldwide.

## Trademark

---

The names used for identification only may be registered trademarks of their respective companies.

## Contact us

If you have any problem, please feel free to contact us.

You can count on us for quick response.

Email : [service@icpdas.com](mailto:service@icpdas.com)

# Table of Contents

<b>1. Introduction</b> .....	<b>1</b>
1.1 Features.....	2
1.2 Applications .....	2
<b>2. Hardware</b> .....	<b>4</b>
2.1 Specifications .....	4
2.2 Appearance and Pin Assignments .....	6
2.3 Dimensions .....	7
2.4 DI/DO Internal Structure and Wire Connection.....	8
2.4.1 DI Internal Structure .....	8
2.4.2 DI mode - NC (normal close).....	8
2.4.3 DI mode - NO (normal open) and Counter .....	9
2.4.4 DO internal structure.....	9
2.4.5 DO wire connection .....	9
2.5 LED Indicators.....	10
2.6 Installing the SMS-530.....	11
2.7 How to reset SMS-530 .....	12
2.7.1 The Li-Battery is applied.....	12
2.7.2 The Li-Battery is not applied.....	12
2.8 Charge and discharge of Li-Battery.....	12
<b>3. Installing the GT-530 Series Utility</b> .....	<b>13</b>
3.1 Installing .NET Compact Framework .....	13
3.2 Installing GT-530 Series Utility .....	15
<b>4. The GT-530 Series Utility Operation Description</b> .....	<b>18</b>
4.1 Main Menu.....	19
4.2 Operation Language .....	21
4.3 Login.....	22
4.4 Device parameter.....	24
4.4.1 Phone /Time Report/Alarm .....	24
4.4.2 DI mode and SMS content .....	27
4.4.3 Import/Export Parameters .....	30
4.5 SMS Recorder .....	31
4.5.1 Counter Report record.....	31
4.5.2 Event Report record .....	32
4.6 Device Time .....	33
4.7 Counter Value.....	34
4.8 Change Password .....	35
4.9 DO control/DI status.....	36
4.10 Battery information .....	37

---

- 4.11 Signal Quality..... 38
- 4.12 Version ..... 39
- 4.13 System..... 40
  - 4.13.1 Recover to Factory Settings..... 40
  - 4.13.2 Reset SMS-530..... 40
- 5. SMS Command..... 41**
  - 5.1 @TIME (Time set and inquiry)..... 42
  - 5.2 @DOCn (DO control) ..... 43
  - 5.3 @ACTV (Counter value inquiry)..... 44
  - 5.4 @DIV (DI/DO inquiry) ..... 45
  - 5.5 @BAT (Battery inquiry) ..... 46
  - 5.6 @PASS (Password inquiry) ..... 47
  - 5.7 @CRPT (Send Counter Report SMS to all phone number) ..... 48
- 6. Send/Receive SMS by COM 3..... 49**
  - 6.1 Send data to COM port of SMS-530 by SMS command ..... 49
  - 6.2 Send SMS by COM 3 ..... 49
- 7. Troubleshooting ..... 50**
- 8. Revision History ..... 51**

# 1. Introduction

SMS-530 is an intelligent 3G SMS controller for industry applications with the simple commands and SMS tunnel function with powered by the external power or Li-Battery. Also, SMS-530 can support UNICODE for users to implement sending SMS messages with various languages. It can provide the SMS report function by setting the return time or DI/counter trigger.

SMS-530 can be a remote control and alarm system allowing you to use your mobile phone to monitor and control your business from any location. Its alarm facilities provide a flexible way to distribute critical alarm information to any number of mobile phone users.

SMS-530 can monitor total 10 digital inputs (6 counters). A SMS can be sent when these DI are triggered or counters exceed preset limits. The user can also interrogate the status of I/O through SMS messages. The SMS-530 also has 2 Digital output which can be activated via DI trigger or SMS to control the lamps, pumps, heaters etc.

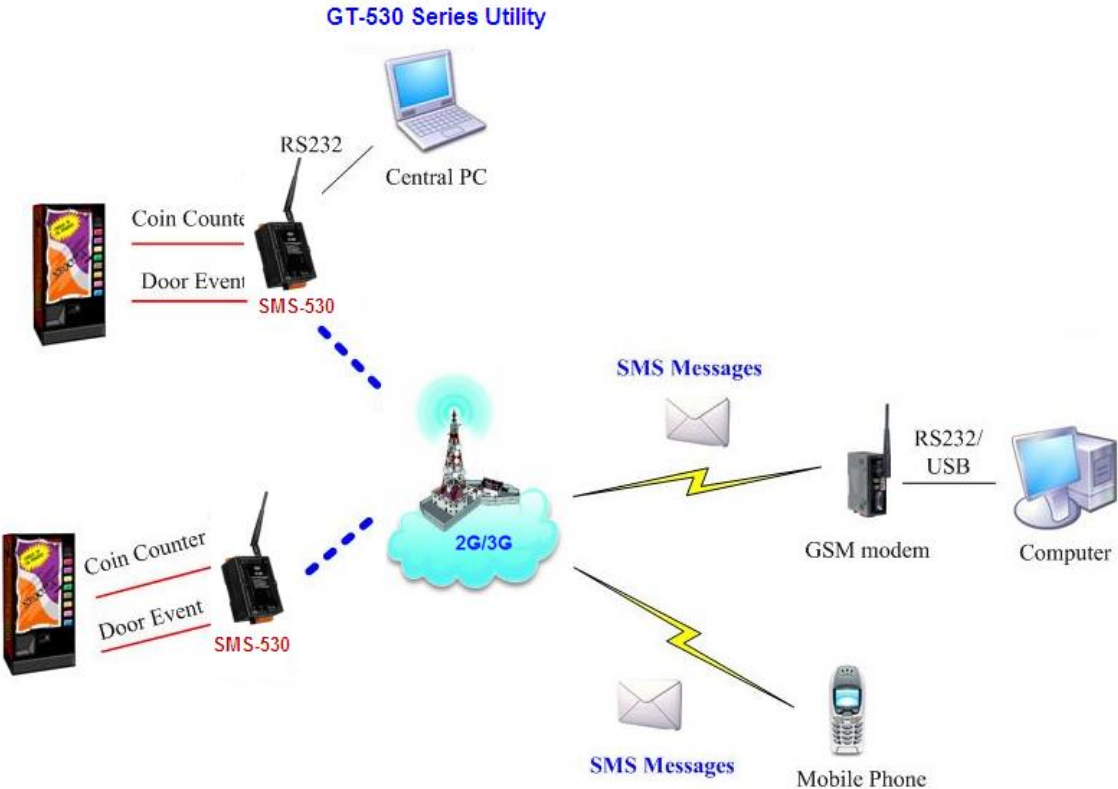

It needs to configure the SMS-530 for the first use.

## 1.1 Features

- Support GSM 850/900/1800/1900 MHz Quad-band frequency
- Support WCDMA 850/900/1900/2100 MHz Quad-band frequency
- Identify 7Bits or UCS2 SMS Automatically
- Support max. 140 ASCII Characters
- Support max. 70 Unicode Characters
- Built-in ASCII Commands and SMS tunnel Communication Modes
- Max. 10 Default Phone Numbers
- Built-in Watch-dog Function
- Industrial Design with Surge Protection
- Support SMS setting and control
- 10 DI (6 Counter), 2 DO, 2 RS-232 port
- Digital input support NC(normal close)/NO(normal open)/Counter modes
- Peroidic SMS report
- Alarm SMS triggered by DI trigger or exceed Counter preset limits
- Support simple command to send SMS via RS-232
- Support DC +10 VDC ~ +30 VDC Power Input
- Supports 3.7 V Li-ion Battery Backup
- DIN Rail design

## 1.2 Applications

- Remote equipment maintenance and automation
- Vending or Gaming monitor system
- Home/Factory security
- Escalators & Elevators

**Application 1 : Signal Alarm and SMS communication**

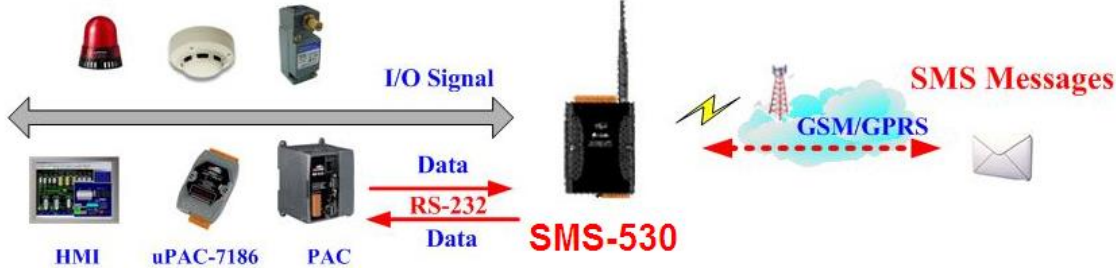

**Application 2 : Home Security**



**Application 3 : Remote Maintenance**



**Application 4 : SMS Tunnel Communication**



## 2. Hardware

### 2.1 Specifications

<b>System</b>	
CPU	32 bit CPU
SRAM	32K Bytes
Flash Memory	512K Bytes
RTC	Gives time(sec, min, hour) & date, leap year compensation
WDT(watchdog)	Yes
<b>Serial Ports</b>	
COM2	RS-232 : TXD, RXD, GND for configuration
COM3	RS-232 : TXD, RXD, GND for communication with other devices
<b>DI/O</b>	
Input	10 Channel ( 6 Counter 5~40Hz + 4 Channel Digital input powered by external power or Li-battery ) On Voltage : +3.5~24VDC Off Voltage : +1V Max.
Output	D/O : 2 Channel Open collector output (100mA@24VDC) Output type : Open-Collector (NPN) Load Voltage : +24V Max. Load Current : 100mA Max.
<b>3G System</b>	
Frequency Band	WCDMA Quad-Band 850/900/1900/2100 MHz
Power Class	Class 3 (250mW @ WCDMA/HSPA)
<b>2G System</b>	
Frequency Band	GSM/GPRS Quad-Band 850/900/1800/1900 MHz
Coding schemes	CS 1, CS 2, CS 3, CS 4
SMS Format	sending : UCS2 receiving : UCS2/7bits
<b>Power</b>	
Protection	Reverse polarity protection
Required Supply Voltage	+10 VDC ~ +30 VDC with 600 mAh Li-ion battery backup (Option :1200 mAh)
Frame Ground Protection	ESD, Surge, EFT, Hi-Pot
<b>Mechanical</b>	
Casing	Plastic



Dimensions(W x H x D)	91 mm x 132 mm x 52 mm
Installation	DIN-Rail
<b>Environment</b>	
Operating Temperature	-25 °C ~ +75 °C
Storage Temperature	-40 °C ~ +80 °C
Humidity	5 ~ 95% RH, non-condensing

## 2.2 Appearance and Pin Assignments

Pin assignments:

- A. DI0 ~ DI5 support counter function which can not be powered by the external power input.
- B. DI6 ~ DI9 can be powered by Li-battery in the absence of the external power input.

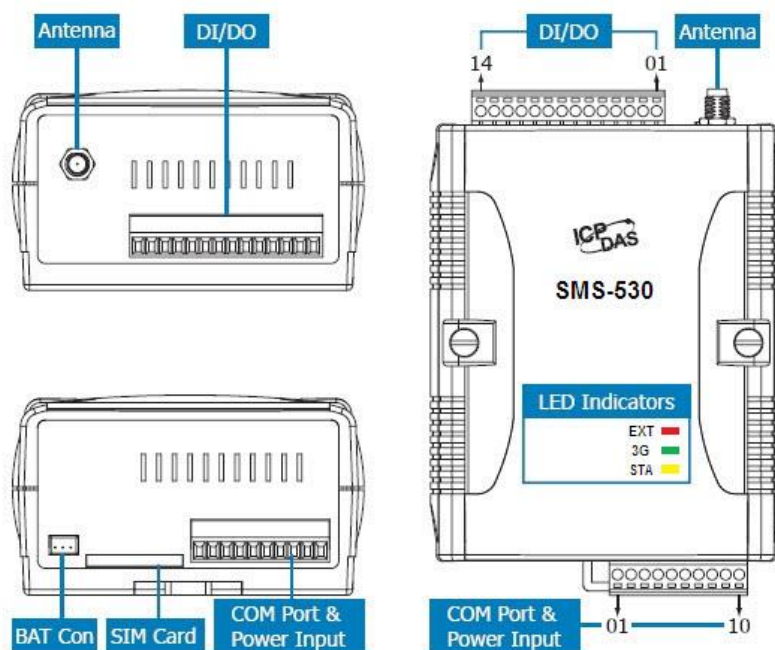

DI/DO		Pin Assignment
Terminal No.		
DI	01	DI0
	02	DI1
	03	DI2
	04	DI3
	05	DI4
	06	DI5
	07	DI6
	08	DI7
	09	DI8
	10	DI9
DO	11	DO0
	12	DO1
	13	DO.PWR
DI/DO	14	Ext.GND

COM Port & Power Input		Pin Assignment
Terminal No.		
COM3 RS-232	01	GND
	02	RxD3
	03	TxD3
COM2 RS-232	04	GND
	05	RxD2
	06	TxD2
N/A	07	N/A
Power Input: +10 ~ +30 V <sub>DC</sub>	08	DC.+VS
	09	DC.GND
Frame Ground	10	F.G

## 2.3 Dimensions

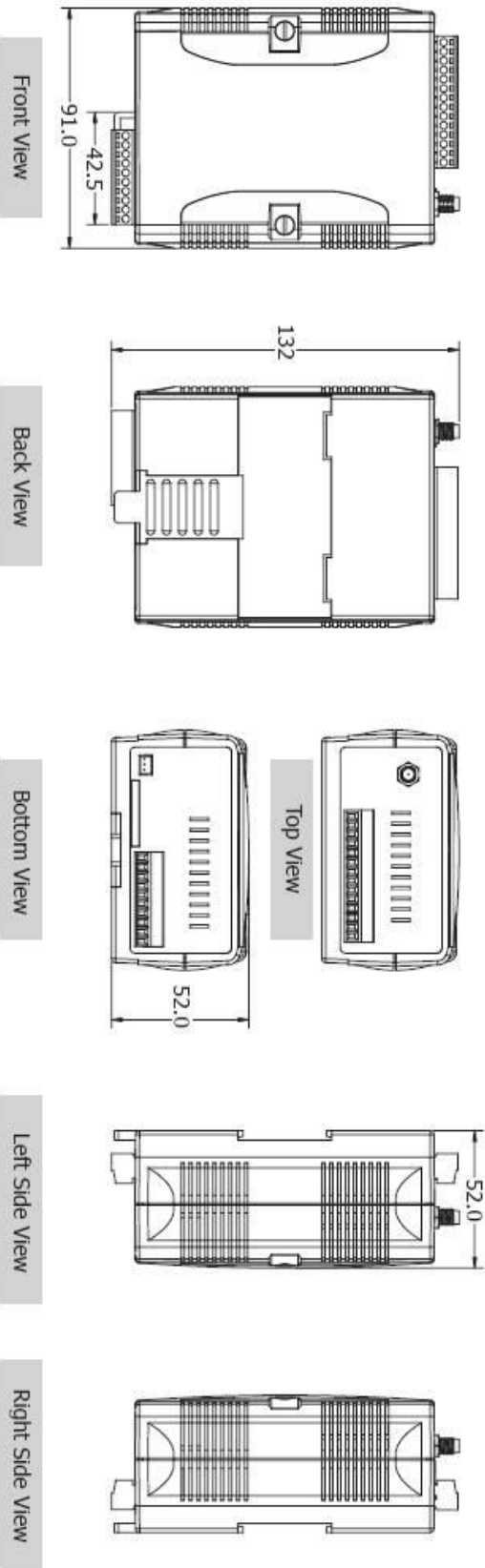

## 2.4 DI/DO Internal Structure and Wire Connection

### 2.4.1 DI Internal Structure

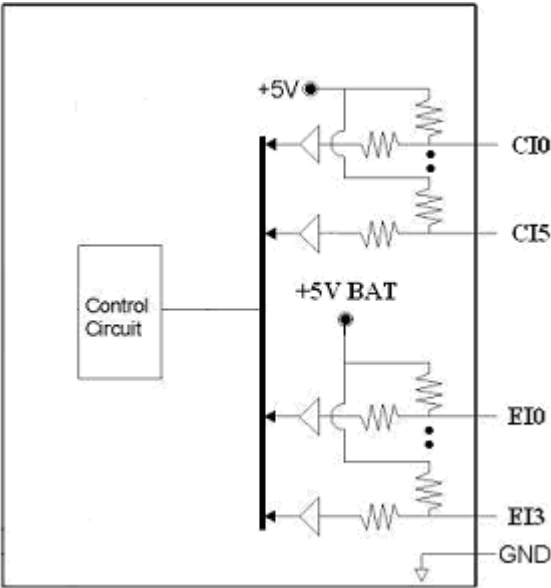





### 2.4.2 DI mode - NC (normal close)

The NC mode is used as normal close in relay application as follows. The logical value of DI is 1 when the relay is ON in normal use. When the relay is triggered as relay open, the logical value of DI is 0 and the alarm SMS would be sent to the users.

Input Type	Not Trigger	Trigger
	ReadBack as 1	ReadBack as 0
Relay Contact	Relay ON	Relay Off
TTL/CMOS Logic	Voltage < 1V	Voltage > 3.5V
Open Collector	Open Collector On	Open Collector Off

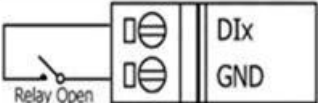
**2.4.3 DI mode - NO (normal open) and Counter**

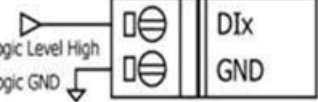

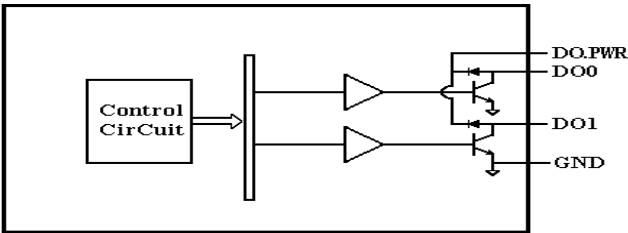

The wire connection in counter and NO modes are the same. The NO mode is used as normal open in relay application as follows. The logical value of DI is 0 when the relay is close in normal use. When the relay is triggered as relay close, the logical value of DI is 1 and the SMS would be sent. If the counter mode is set, the trigger signal must be maintained as 25 ms ~ 200 ms.

Input Type	Trigger	Not Trigger
	ReadBack as 1	ReadBack as 0
Relay Contact	Relay ON 	Relay Off 
	TTL/CMOS Logic	
TTL/CMOS Logic	Voltage < 1V 	Voltage > 3.5V 
	Open Collector	Open Collector On 

**2.4.4 DO internal structure**



**2.4.5 DO wire connection**

	Relay ON	Relay Off
Drive Relay		
Resistance Load		

## 2.5 LED Indicators

There are three LED indicators to help users to judge the various conditions of SMS-530. The description is as follows:

- A. EXT (Red): The External Power LED to indicate whether the external power is input or not. The description is as follows:

The power is active	The power is not active
ON	OFF

- B. 3G (Green): The modem LED can indicate the status of 3G module. (After modem registered)

	3G module normal	3G module fail
GPRS Mode	Blinking per 2 sec	OFF or Blinking (not 3 sec)
WCDMA Mode	Blinking twice per 2 sec	

- C. STA (Orange): The System LED is to indicate if the SMS-530 is normal or fail.

Condition Ext. power	Condition			
	Normal(idle)	Running	3G error	Wrong PIN/PUK code
ON	Blinking (1 sec)	Blinking (0.5 sec)	Always ON or OFF	Blinking (50 ms)
OFF	OFF(sleep mode) or Blinking (1 sec) (wake up)	Blinking (0.5 sec)	Always ON	Blinking (50 ms)

## 2.6 Installing the SMS-530

If users want to start SMS-530 normally, it needs to follow these steps to install the SMS-530 below:

- A. Install the antenna.
- B. Plug in the normal SIM card. (Before apply the SIM card, confirm it is OK by mobile phone.)
- C. Pin08 and Pin09 connect to the DC.+VS and DC.GND of the power supply.
- D. Follow the section 2.4 to wire the I/O connection.
- E. If you want to use the backup power, please connect the Li-battery to SMS-530.
- F. It is needed to wait for 30 ~ 50 seconds to search the 3G base and register to the ISP. After finishing the process, SMS-530 would be in normal operation mode and the STA LED would blank per 1 sec. The start time of SMS-530 depends on the strength of signal.

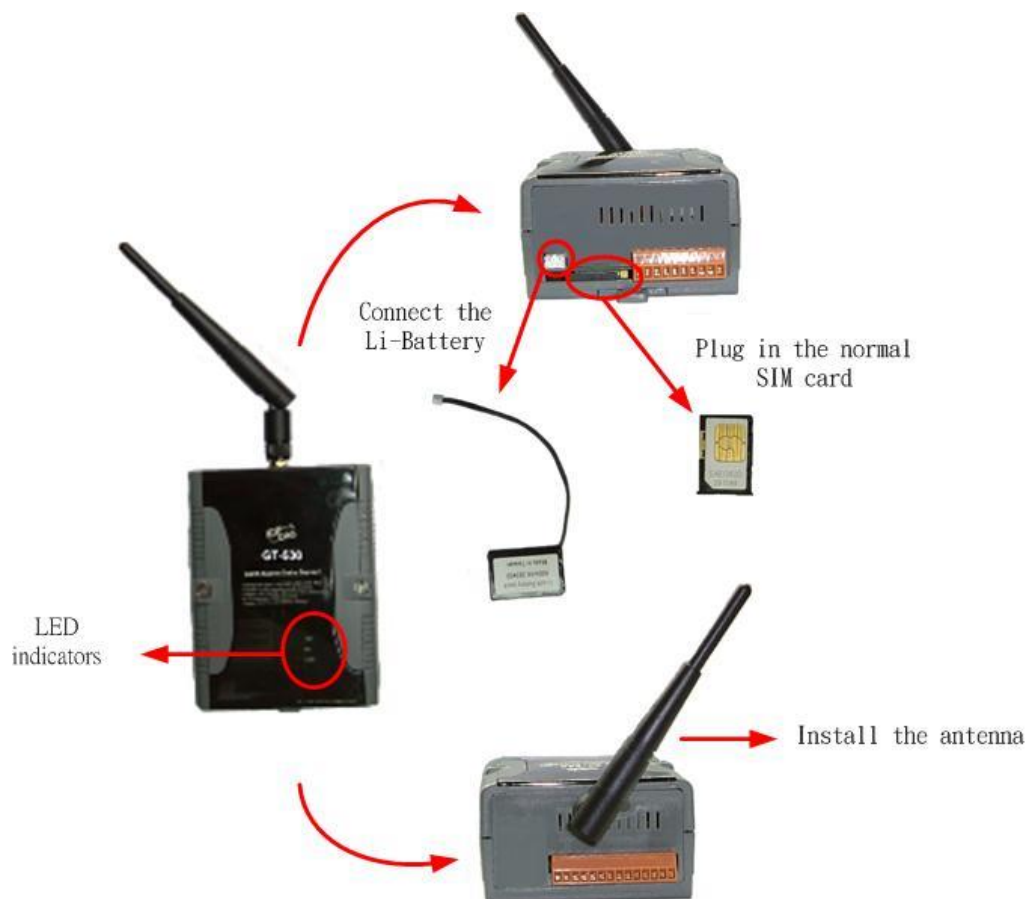

## 2.7 How to reset SMS-530

### 2.7.1 The Li-Battery is applied

- (1) Remove Li-Battery from SMS-530.
- (2) Turn off the external power and confirm the EXT LED is off.
- (3) Turn on the external power.
- (4) Re-install the Li-Battery.

### 2.7.2 The Li-Battery is not applied

- (1) Turn off the external power and confirm the EXT LED is off.
- (2) Turn on the power.

## 2.8 Charge and discharge of Li-Battery

If users apply the Li-Battery on SMS-530, the Li-battery would be charged by the external power automatically. When the external power is removed from SMS-530, the power supplying to SMS-530 is from Li-Battery. If the voltage of Li-Battery is lower than the preset limit, SMS-530 can send the SMS message to inform the users.

### Tips & Warnings

---



**A new Li-Battery can supply power to SMS-530 for 36 hours without the external power. The power volume of Li-Battery would be decreasing for a long time. It is recommended to change the Li-Battery every 6 months.**

---



### 3. Installing the GT-530 Series Utility

It needs the runtime environment with .NET Framework 2.0 or above to execute the GT-530 Series Utility in the PC. If there has .NET Framework 2.0 or above in the PC, the section 3.1 can be omitted.

#### 3.1 Installing .NET Compact Framework

The user can download the .NET Compact Framework 2.0 or above from Microsoft web site. The install figure is as follows:

- (1) Press "Next" to the next step.

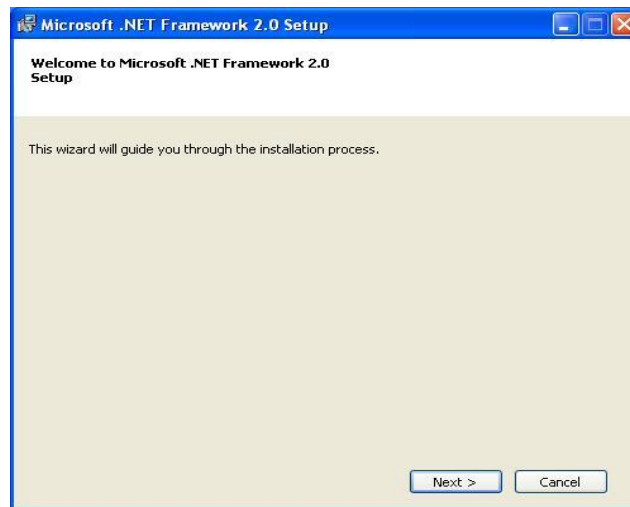

- (2) Select the "I accept the terms of the License Agreement" and "Install" to the next step.

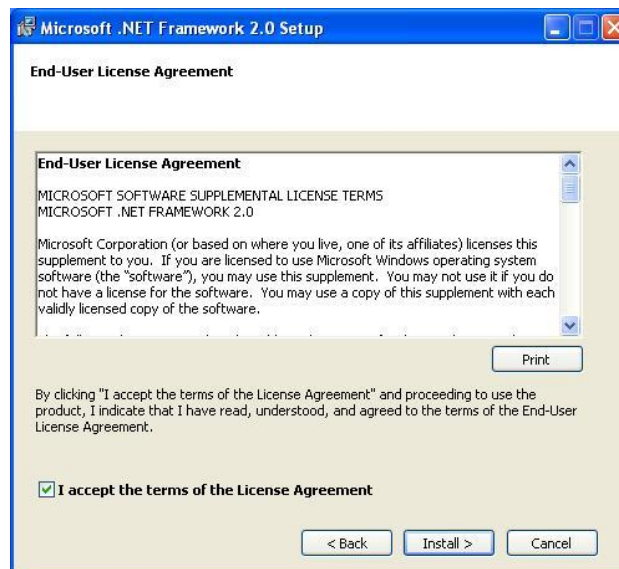

(3) The installation process would be going.

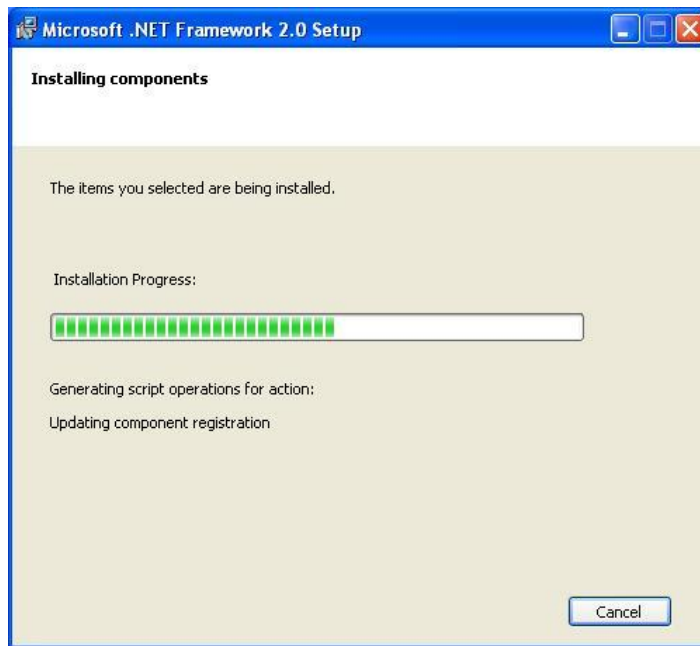

(4) After finishing the installation, press "Finish" to exit the program.

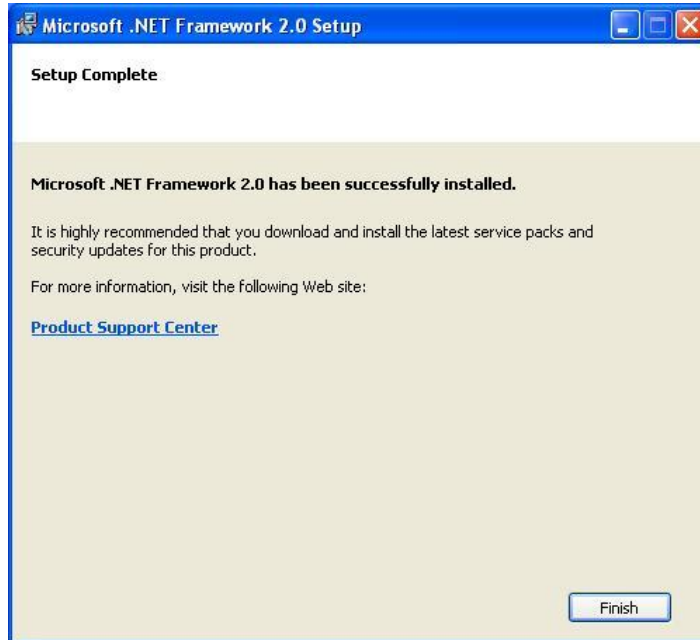

## 3.2 Installing GT-530 Series Utility

- A. Plug in the shipment CD into the PC
- B. Execute \software\pc\_utility\Install\_GT530\_Series\_Utility\_Vxxx.exe

The installation figure is as follows:

- (1) Press “Next” to start the installation procedure.

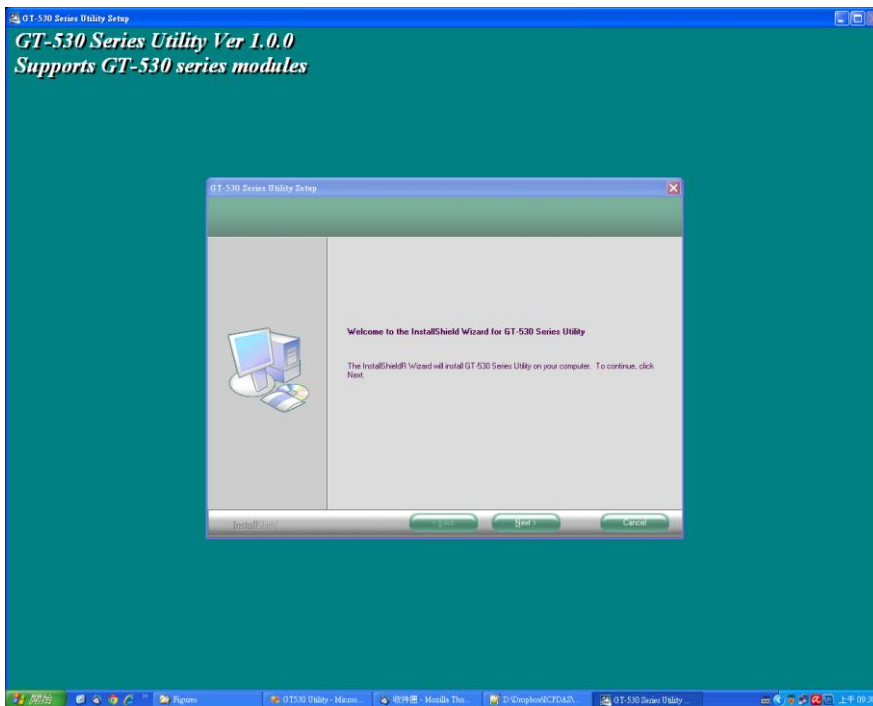

- (2) Select the installation path. The default path is “C:\Program Files\GT-530 Series Utility”. Press “Next” to the next step.

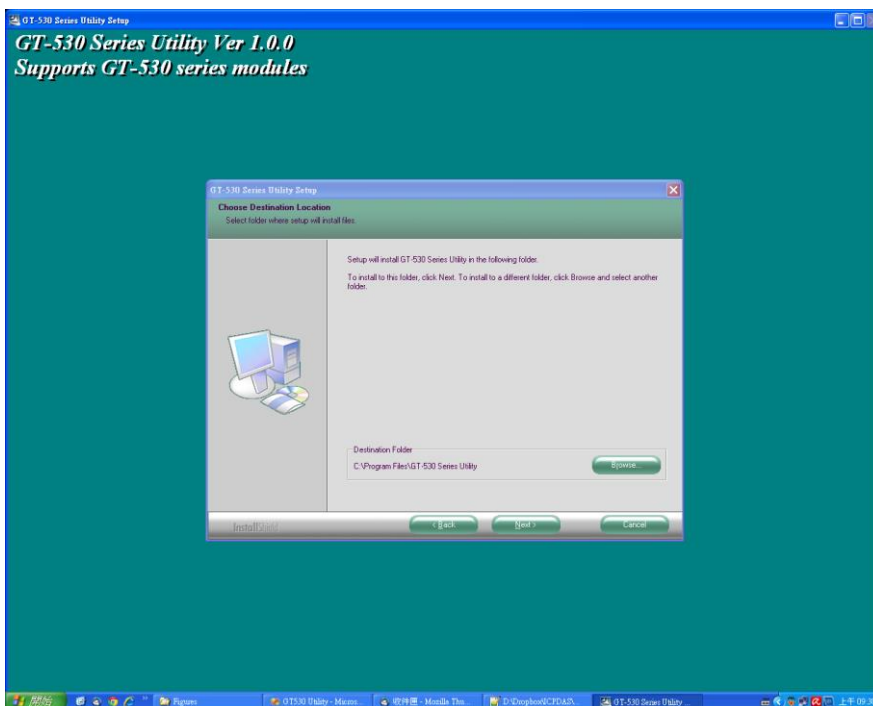

- (3) Input the name shown in “All Programs”. Press “Next” to the next step.

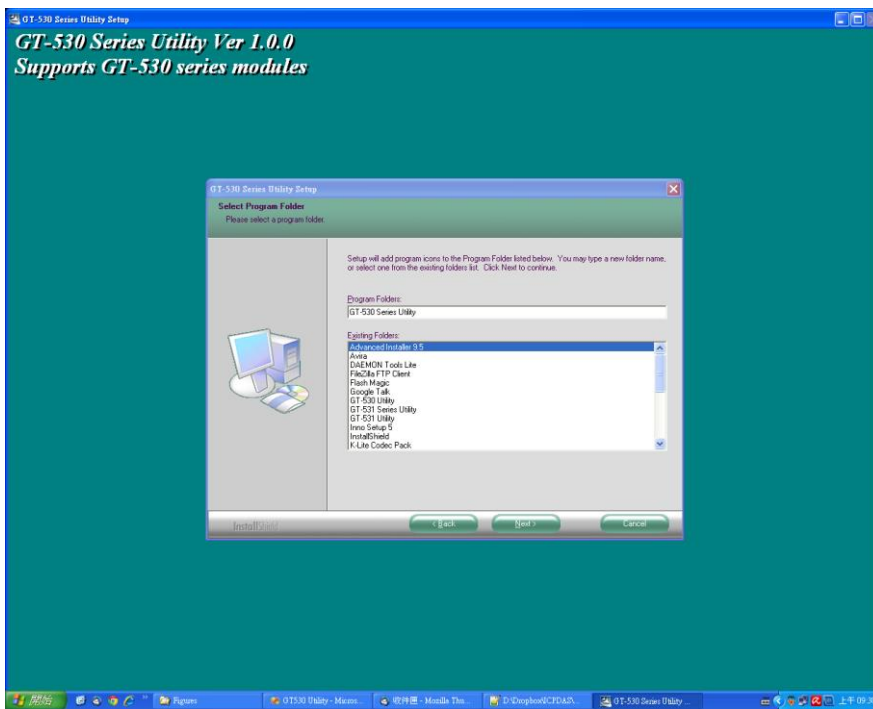

- (4) After finishing the installation procedure, press “OK” to the next step.

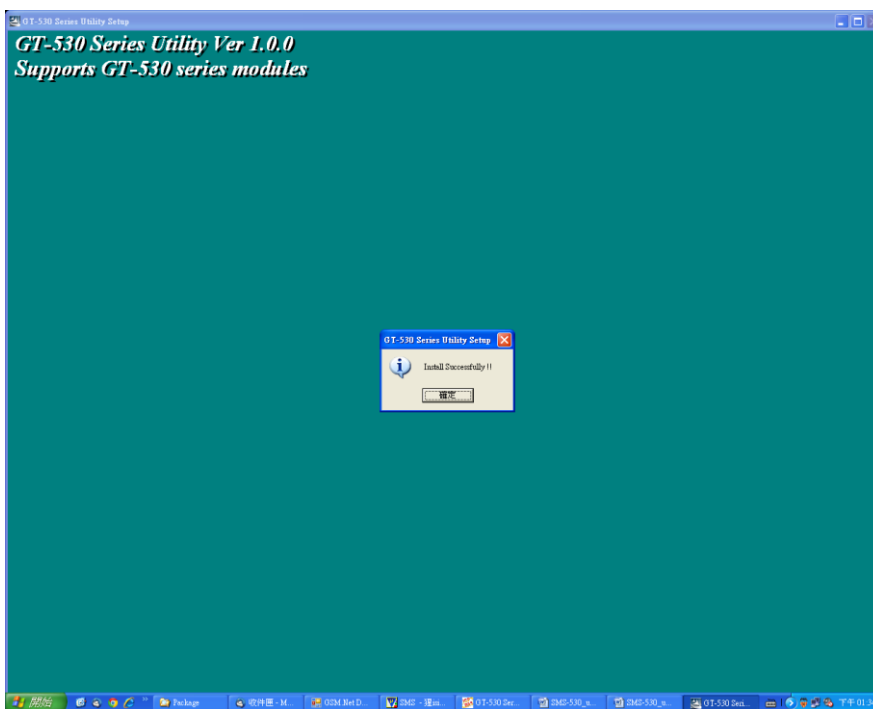

- (5) Press “Finish” to finish the installation procedure.

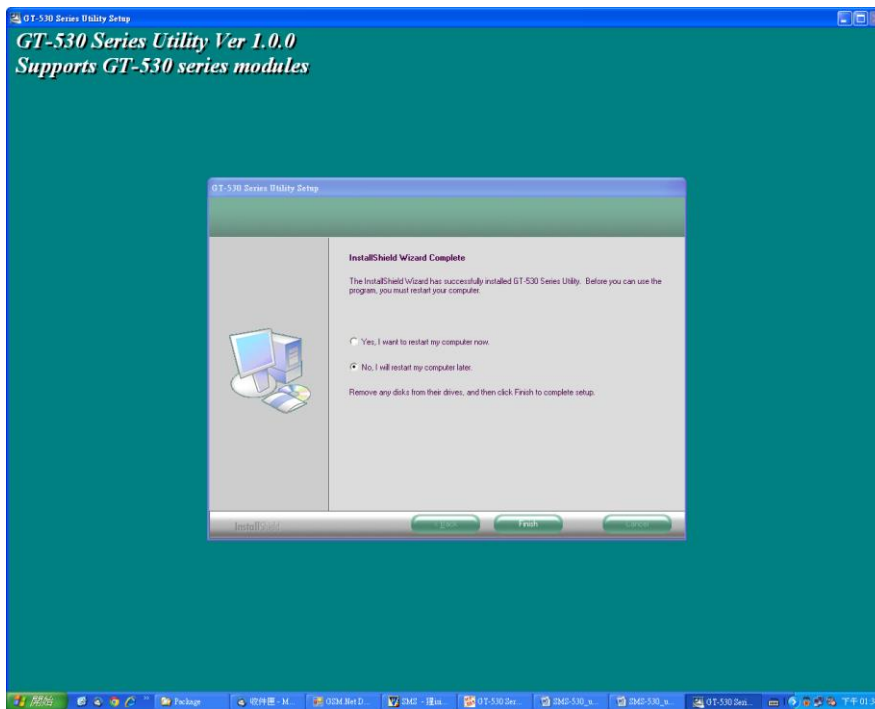

- (6) Launch GT-530 Series Utility from the start menu: “Start → All Programs → GT-530 Series Utility → GT-530 Series Utility”.



## 4. The GT-530 Series Utility Operation Description

Before GT-530 Series Utility is connected to the PC correctly, please confirm these following steps:

1. The STA LED is blanking. There are 2 kinds of blanking in the SMS-530.

STA LED	Description
Blinking per 1 sec	Normal mode
Blinking per 50 ms	The pin code is wrong. The login windows would show the field to input PIN or PUK code

2. Confirm the RS-232 wire connection between the SMS-530 and PC is correct. Users can refer to the following figure.
3. During the setting procedure, the external power must be turn on.

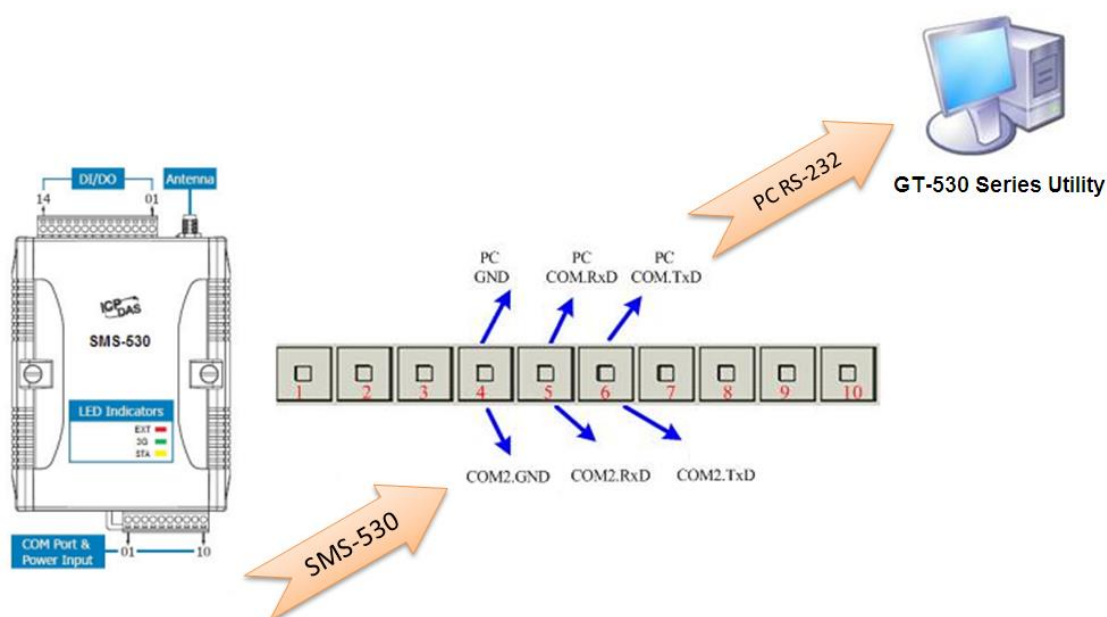

### Tips & Warnings



If the STA LED is always on, please reset SMS-530. Refer to section 2.7 for the detail.

## 4.1 Main Menu

The main menu of GT-530 Series Utility includes the following sections:

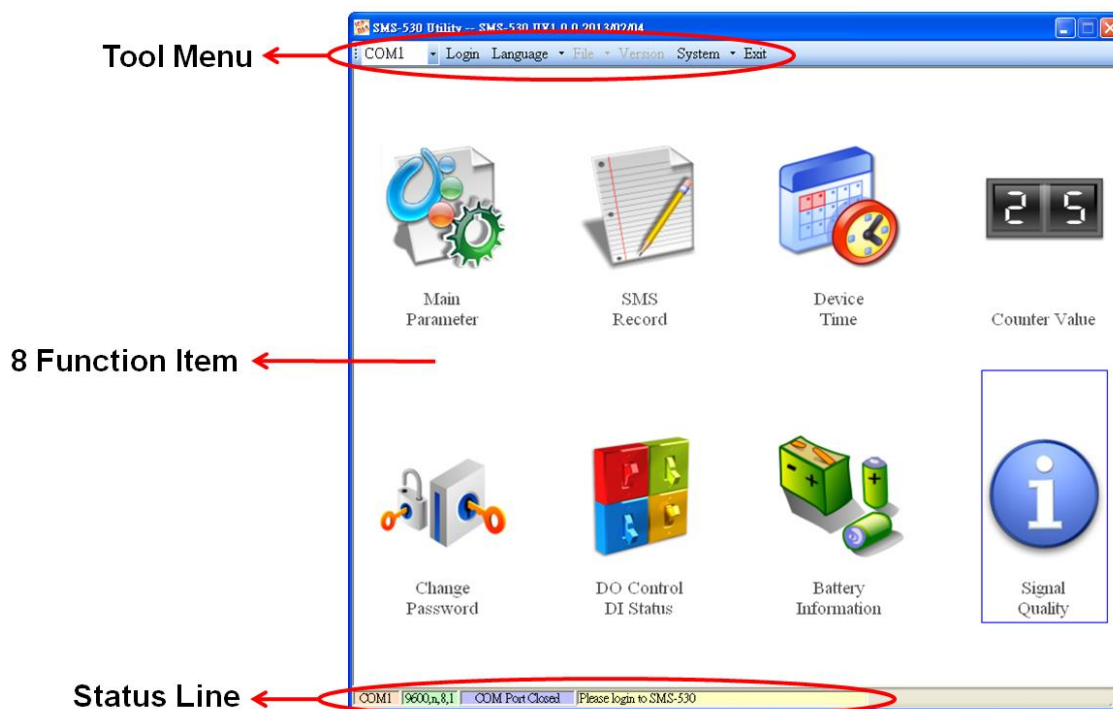

### A. Tool Menu

1. COM: Set the COM port number in PC connecting to SMS-530.
2. Login/Logout:  
Before operating SMS-530, users need to login to GT-530 Series Utility. After login the system successfully, the menu item “login” would become “logout” and the GT-530 Series Utility would be operated normally. Once the power is reset, the login procedure needs to do again.
3. Language:  
GT-530 Series Utility supports English, Tradition and Simplified Chinese interface. Users can select which language interface they want from the “Language” item. The language setting would be influencing on the encode of SMS.
4. File:  
There are import and export functions in “File” item. The functions would be enabled when “Main parameters” window is open.
  - (1) Export: The function can export the parameters as .par file from the “Main parameters” windows.
  - (2) Import: The parameters would be shown in “Main parameters” window from the specific .par file.

5. Version: Including the firmware and Utility version information.
6. System: Provide users for recovering SMS-530 to factory and resetting SMS-530.
7. Exit: To exit GT-530 Series Utility.

B. 8 Function Item

1. Main parameter: The main parameter setting of SMS-530 includes ID, SIM number, 10 phone number authority, counter return report, event, DI mode and SMS message.
2. SMS record: Inquire the report recorder of event and counter. The maximum number of recorder in SMS-530 is 64.
3. Device time: Display and set the RTC time of SMS-530. It is also can get the information of the last and next time of the return report.
4. Counter Value: Inquire and set the counter value.
5. Change Password: Change the login password.
6. DO Control/DI status: Display the status of I/O and control the DO output.
7. Battery information: Show the voltage and volume of Li-Battery.
8. Signal Quality: Show 3G signal strength in SMS-530.

C. Status Line

Show the related information during the operation procedure including:

1. The com port number of PC
2. The communication setting of COM Port
3. The status of COM Port
4. The result of Utility operation



## 4.2 Operation Language

GT-530 Series Utility supports English, Traditional Chinese and Simplified Chinese from the “language” menu bar. The text display in GT-530 Series Utility and the encode of SMS are depended on the selected language interface.

The format of SMS accords to the selected language. If the 7 BITS format is set, the maximum characters can be sent in SMS is 140. If UCS2, the maximum number is 70 characters. Therefore, if users want to send the Chinese message, it need to select UCS2 encode. After setting the language, it needs to reset SMS-530 to enable the setting.

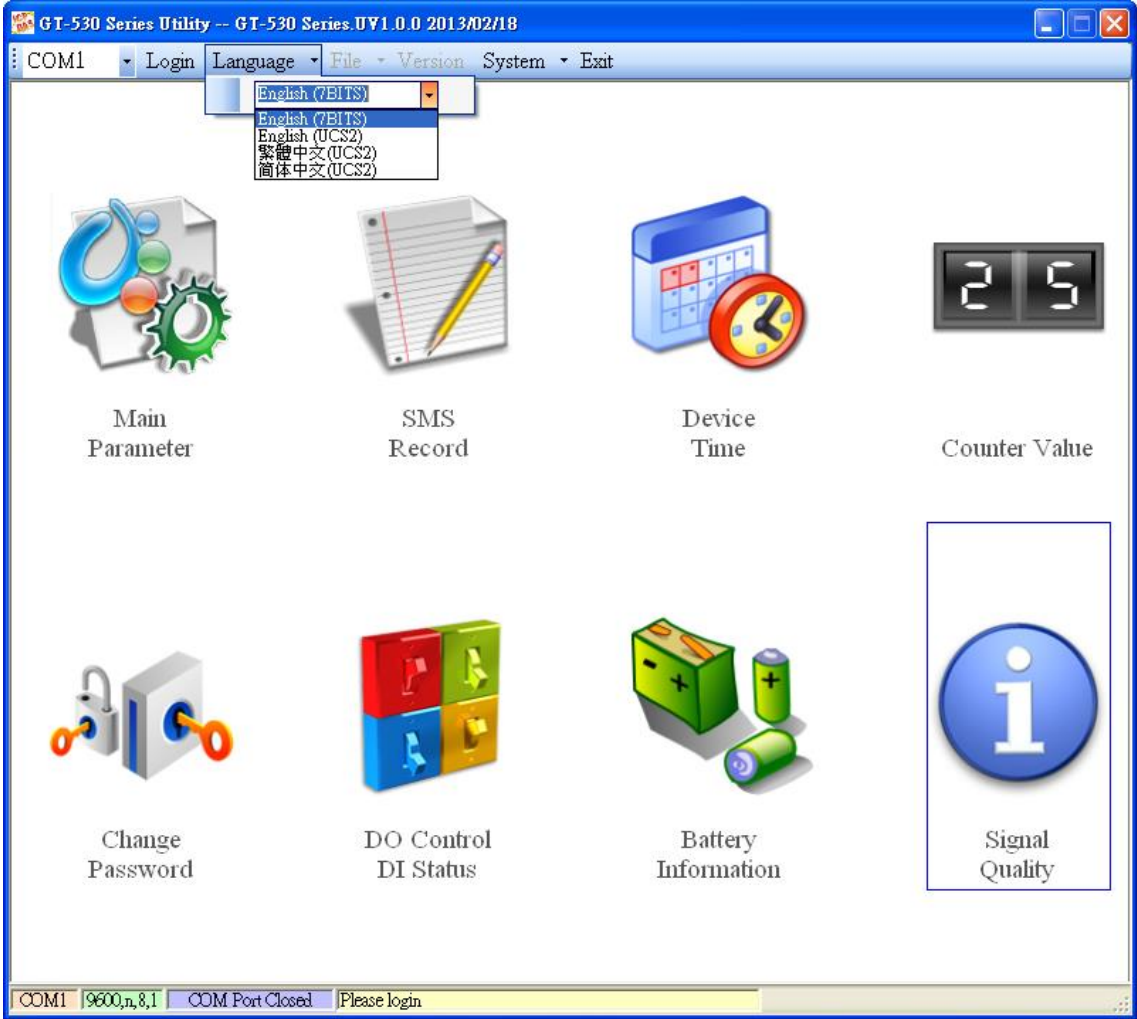

## 4.3 Login

It needs to login into SMS-530 to set its parameters. The description is below:

- (1) Select the COM port number of PC.
- (2) Input the login password. The default is "111111".
- (3) Press the "login" button.
- (4) If you are the first time to login, please set the time of SMS-530.

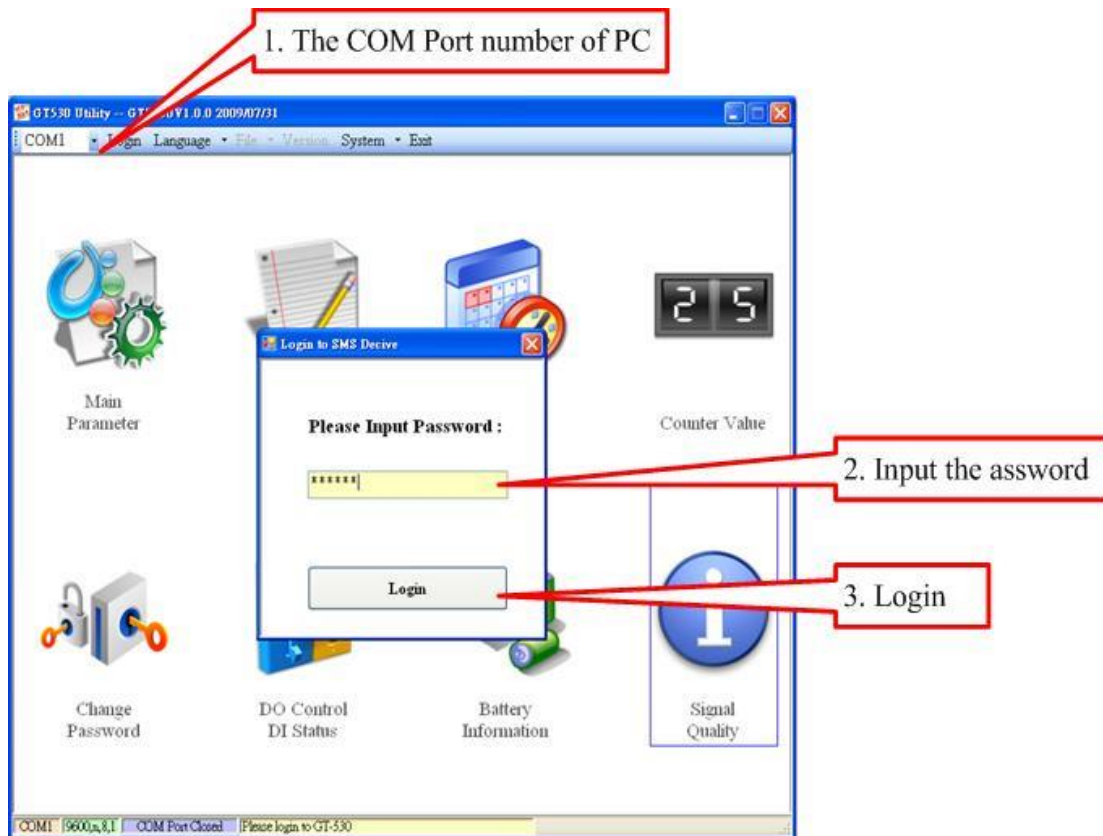

If the pin code in SMS-530 is not correct, the STA led would be blanking per 50 ms and GT-530 Series Utility would ask for users to input Pin or PUK code.

(1) Asking for inputting PIN code

If the PIN code is effective, the “Enter SIM PIN/SIM PUK” window would pop-up as follows. If the number of times for inputting the wrong PIN code is more than the allowed number, the PIN code would be ineffective. And the “PUK code” window would pop up.

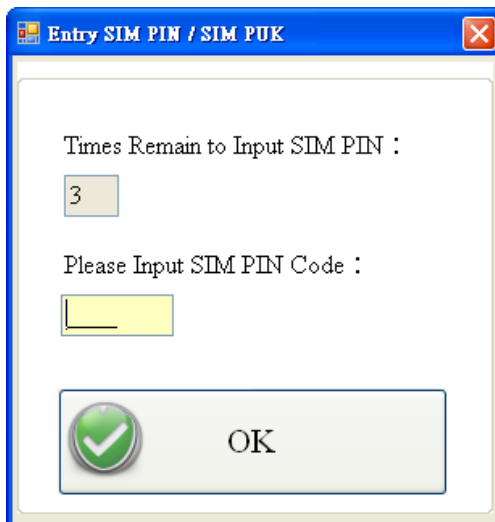

(2) Asking for inputting PUK code

If the PIN code is ineffective, the “PUK code” window would pop-up as follows. As the number of times for inputting the wrong PUK code is more than allowed number, the SIM card would be ineffective forever. Therefore, it is important to input the correct PUK code.

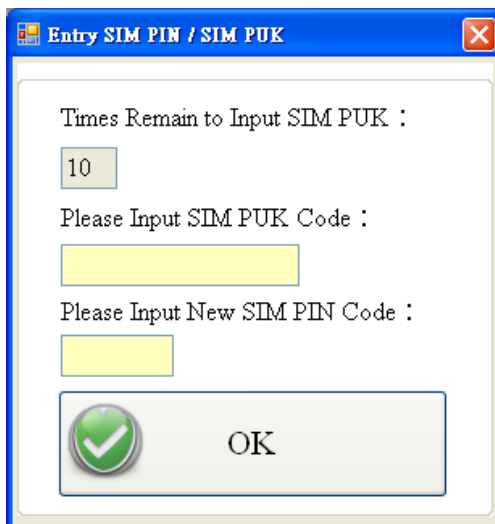

### Tips & Warnings



If the PIN or PUK code is correct, the STA led would blank per second. Users can operate other function of SMS-530 in this utility.

## 4.4 Device parameter

There are 2 pages in “Device parameter” window. They are “Phone/Time Report/Alarm” and “DI Type/Text Message” pages.

After configuring the 2 pages, press “Write to Device” button to save these settings to SMS-530. Then, reset SMS-530 to enable these settings.

The “Read Form Device” button can help users to read back these settings from SMS-530. In addition, these setting would be read from SMS-530 when the “Main Parameter” window pops up from the main menu.

### 4.4.1 Phone /Time Report/Alarm

The following page is “Phone/Time Report/Alarm”. Users can refer the explanation below:

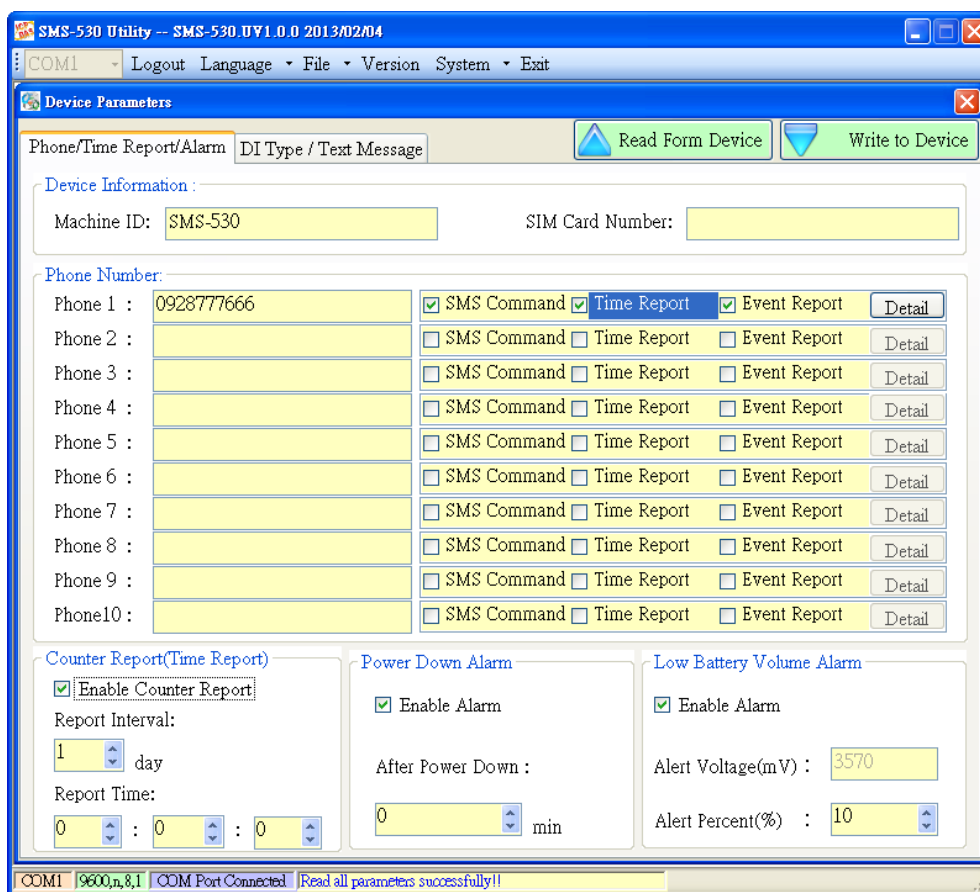

1. Machine ID

The device ID would be shown in the report and alarm SMS messages. It can be used for recognizing the SMS-530. The length of characters is 20 without supporting unicode and “;” characteristic.

2. SIM Card Number

This text field can show or input the phone number of the plug-in SIM card. Take Taiwan for example: 0928xxxxxx.

## 3. 1~ 10 Phone numbers

This field is used to set which phone numbers to receive SMS message or send SMS command. Every phone number can be set the authority as follows:

- (1) SMS command: Authority to send the SMS commands to SMS-530.
- (2) Time Report: Authority to receive the counter SMS report periodically.
- (3) Event Report: Authority to receive the event SMS report and the user can click the "Detail" button to set the detail event authority for this phone number. If not selected the event, the phone number will not receive the event SMS.
- (4) Detail: User can set the details of the event report including four system event and 10 DI event.

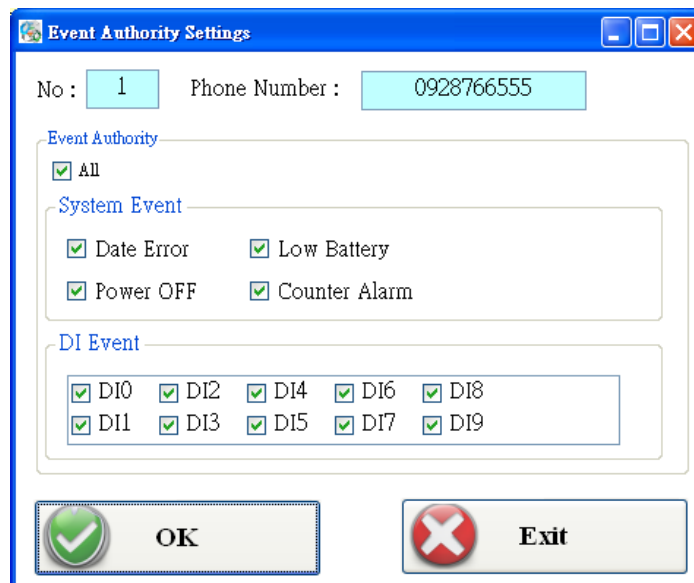

## 4. Counter Report (Time report)

- (1) Enable Counter Report: Enable the function in this item.
- (2) Report Interval: The time interval for counter report and it is set by day (1 ~ 31).
- (3) Report time: Hour/Minute/Second.

Note: The SMS format of counter report is fixed. It can not be modified by users:

`CRPT;Machine ID;Report Date;Report Time;DI0;DI1;DI2;DI3;DI4;DI5`

CRPT: Counter report

Machine ID: SMS-530

Report Date: The format is YYYYMMDD (YYYY=year, MM=month, DD=day)

Report Time: The format is HHMMSS (HH=hour, MM=minute, SS=second)

DI0 ~ DI5: The counter values of DI0 ~ DI5.

Note: If these DI channels are not set as counter mode, the counter value would be zero.

If CRPT function is enabled and the return time is changed, the next time to send the SMS report is re-calculated according to the current time of SMS-530 and the CRPT time. There would 2 conditions on the day:

- (1) When the SMS-530 time is over the CRPT time, SMS-530 would send the CRPT SMS after 1 minute.
- (2) If the SMS-530 time does not reach the CRPT time, SMS-530 would not send the CRPT SMS until SMS-530 time reaches the CRPT time.

5. Power Down Alarm

The function supports to send alert SMS when the external power is off. The alert time after the event happened can be set by minutes (0 ~ 60 minutes).

6. Low Battery Volume Alarm

The function supports to send alert SMS when the volume of battery is low. The low battery value can be set as 10%~ 50% less than total volume.

## 4.4.2 DI mode and SMS content

The another page in “Main Parameter” is about DI and event setting. The explanation is below:

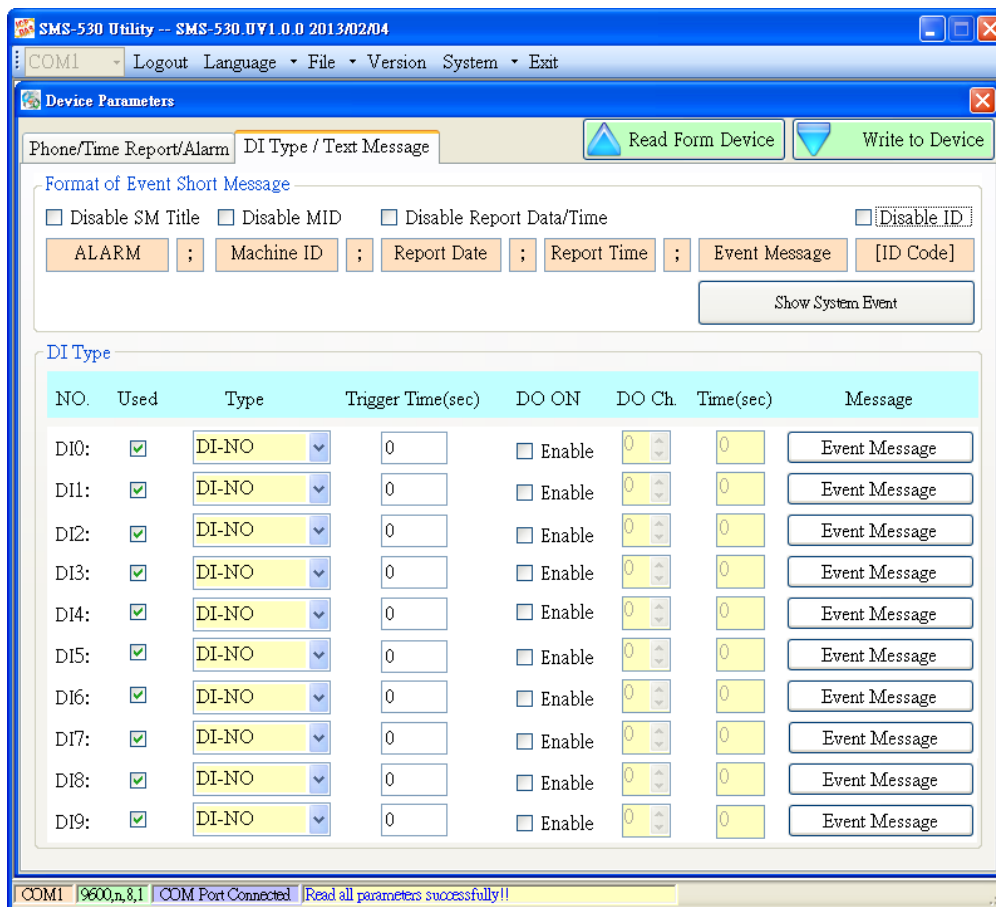

### 1. The format of event Shot Message

The format of event SMS can be modified by users by the check boxes. The complete format of even SMS is below:

`ALARM;Machine ID;Report Date;Report Time;Event Message`

ALARM: Indicate alarm report

Machine ID: Device ID

Report Date: The format is YYYYMMDD (YYYY=year, MM=month, DD=day)

Report Time: The format is HHMMSS (HH=hour, MM=minute, SS=second)

Event Message: User-defined content

The four messages of event SMS can be set or canceled by users to match various applications. They include:

- (1) Disable SM Title: Enable the function. The title string “ALARM” would not be sent in SMS

- (2) Disable MID: Enable the function. The machine ID would not be sent in SMS
- (3) Disable report Data/Time: Enable the function. The data and time would not be sent in SMS.
- (4) Disable ID: Disable this function. A check ID would be sent in SMS and customer can use ICPDAS's SMS management software. (SMS-530 SMS Database System software)

## 2. Show System Event

The window shows the system event message according to the selected language. The content is fixed and can not be changed. There are 4 system events in SMS-530 as follows:

- (1) Event 1: The external power is off. (This function can be disabled)
- (2) Event 2: The volume of battery is lower than the setting value. (This function can be disabled). n is the remaining percentage volume of battery.
- (3) Event 3: The time of SMS-530 is abnormal. This function can not be disabled. It could make the wrong timing for report and the cause is the silver battery of SMS-530 is abnormal. After changing the silver battery, the time of SMS-530 must be set.
- (4) Event 4: The counter value is reaching the preset limits. This function can be disabled. n represents the number of DI channel. (n: 0 ~5)

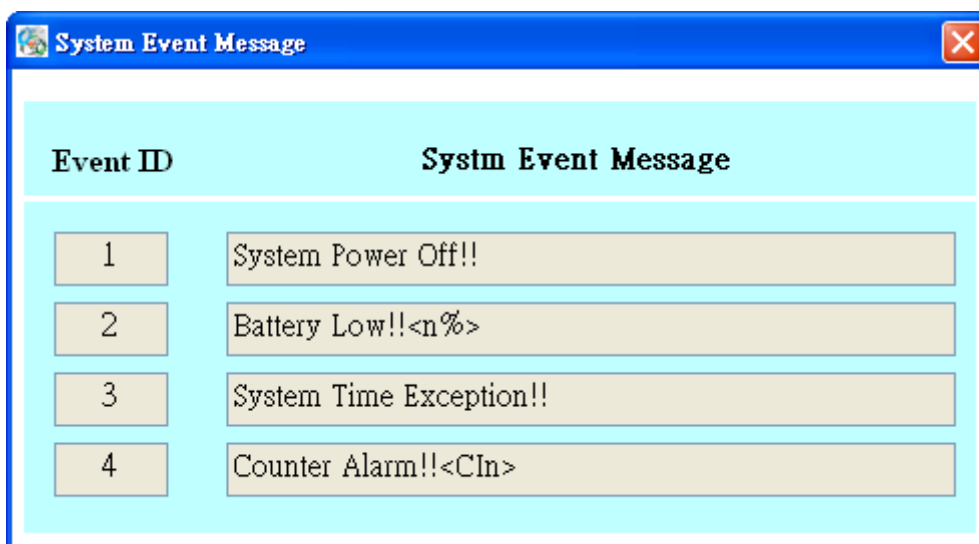

Event ID	System Event Message
1	System Power Off!!
2	Battery Low!!<n%>
3	System Time Exception!!
4	Counter Alarm!!<CIn>



### 3. DI type

There are 3 modes of DI type for users to select. It needs to reset SMS-530 to enable new setting after changing these parameters.

- (1) Used: Enable DI function.
- (2) Type: DI0 ~ DI5 could be set as Counter function, NC or NO mode and DI6~DI9 can be NC or NO mode.
  - ◆ Counter: Counter function (frequency : 5 ~ 40Hz)
  - ◆ DI-NC: Normal Close mode. When the DI circuit is broken, the event is triggered. SMS-530 would send the alarm SMS. Refer to section 2.4.2 for the detail.
  - ◆ DI-NO: Normal Open mode. When the DI circuit is shorten, the event is triggered. SMS-530 would send the alarm SMS. Refer to section 2.4.3 for the detail.
- (3) Trigger Time(sec): Set the hold time of the DI triggered signal (0~9999 seconds).
- (4) DO ON: This function enable DO output when DI event is triggered.
- (5) DO Ch.: Set the DO channel.
- (6) Time(sec): Set the output time of DO channel (0~999 seconds). If the power is just provided by Li-battery, SMS-530 would not be into sleep mode until the output time is reaching.
- (7) Event message: Set the user-defined message content. These message would be included in event SMS.

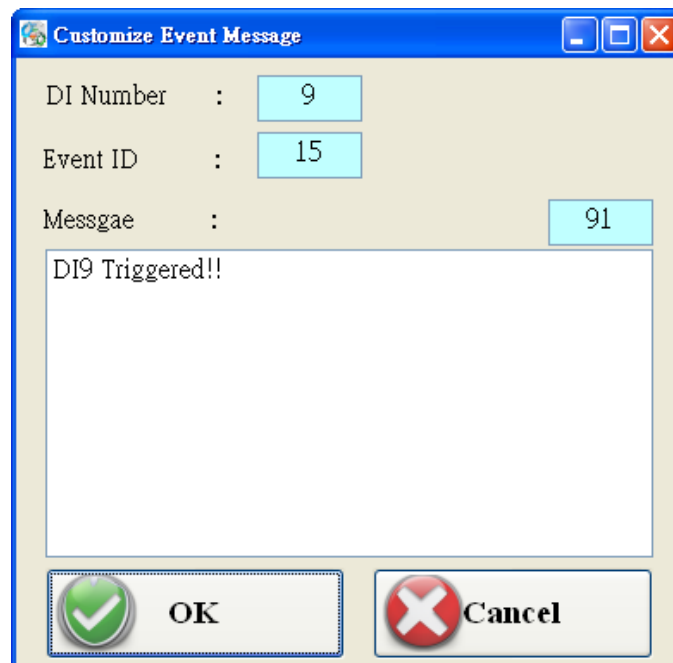

### 4.4.3 Import/Export Parameters

Users can use the import and export functions from the menu bar. This function would be enabled when the “Device Parameter” window is open. The explanation is below:

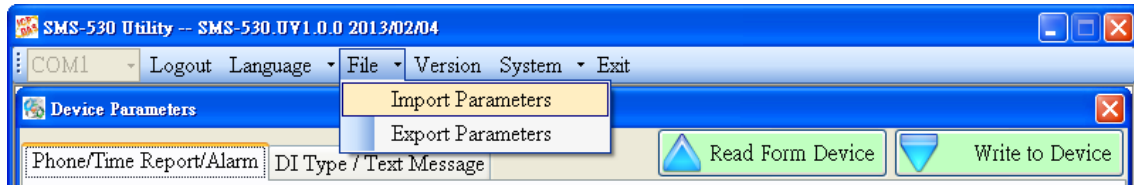

1. **Import Parameters:** This function is used for reading back the setting of device parameters from .par file and displaying in “Device parameter” window. When press “import” button, a file selection window would pop up for users to choice the .par file.

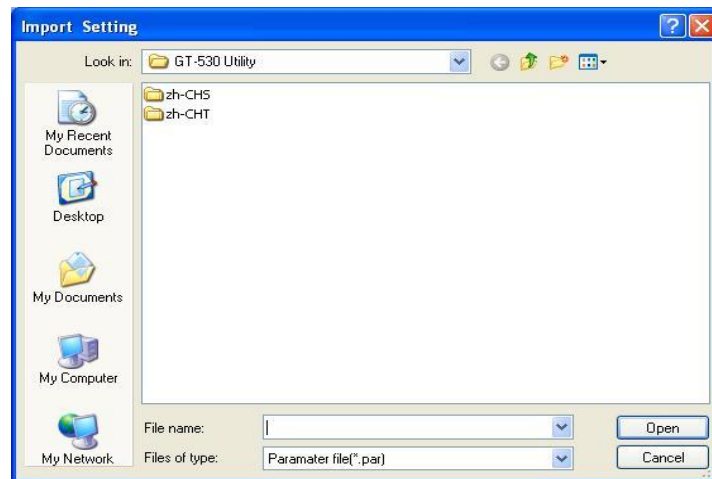

2. **Export Parameters:** The function is used for saving the setting of “Device parameter” window as .par file. When press “Export” button, a file selection window would pop-up for users to save the setting as .par file in specific path.

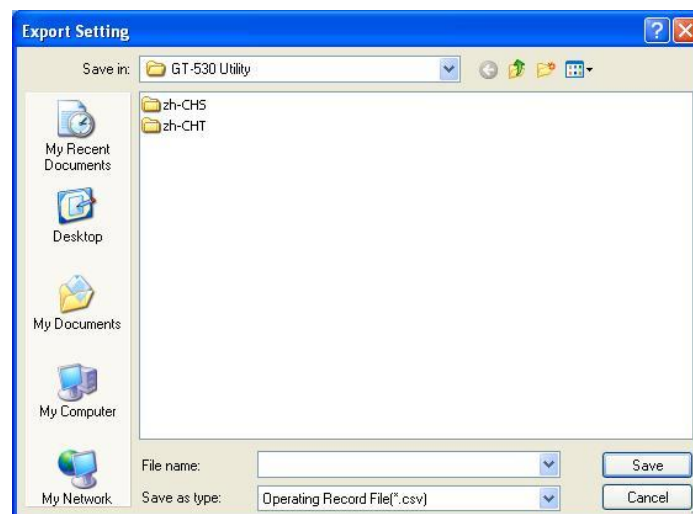

## 4.5 SMS Recorder

This window provides the inquiring, saving and deleting counter value, and event SMS record function.

### 4.5.1 Counter Report record

In this page, users can inquire the record of CRPT reports:

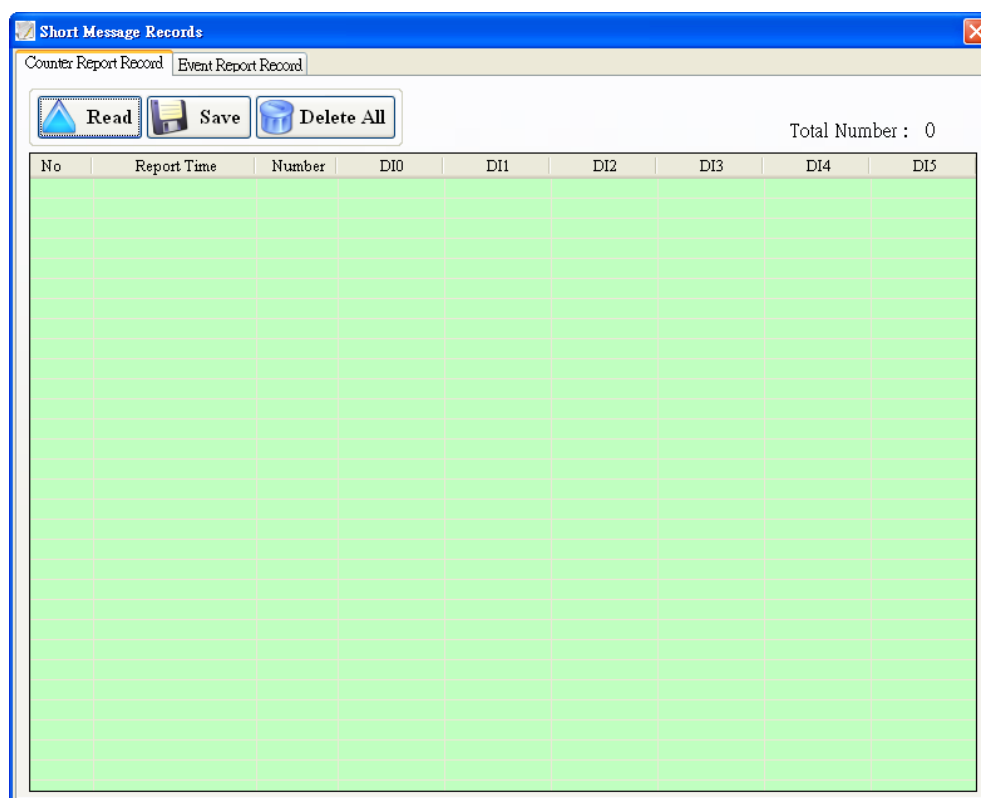

Operation:

- (1) Read: Read all the CRPT report from SMS-530. The maximum number of CRPT report record is 64.
- (2) Save: Save these records to a file(\*.csv).
- (3) Delete all: Delete all CRPT report records from SMS-530.

Text field:

- (1) No: The number of CRPT records.
- (2) Report time: CRPT report time.
- (3) Number: It represents the SMS sending to the quantity of phone numbers.
- (4) DI0: The DI0 counter value. If the DI is not set as counter, the value is 0.
- (5) DI1: The DI1 counter value. If the DI is not set as counter, the value is 0.
- (6) DI2: The DI2 counter value. If the DI is not set as counter, the value is 0.
- (7) DI3: The DI3 counter value. If the DI is not set as counter, the value is 0.
- (8) DI4: The DI4 counter value. If the DI is not set as counter, the value is 0.
- (9) DI5: The DI5 counter value. If the DI is not set as counter, the value is 0.

## 4.5.2 Event Report record

In this page, users can inquire all event report of SMS-530. The explanation is below:

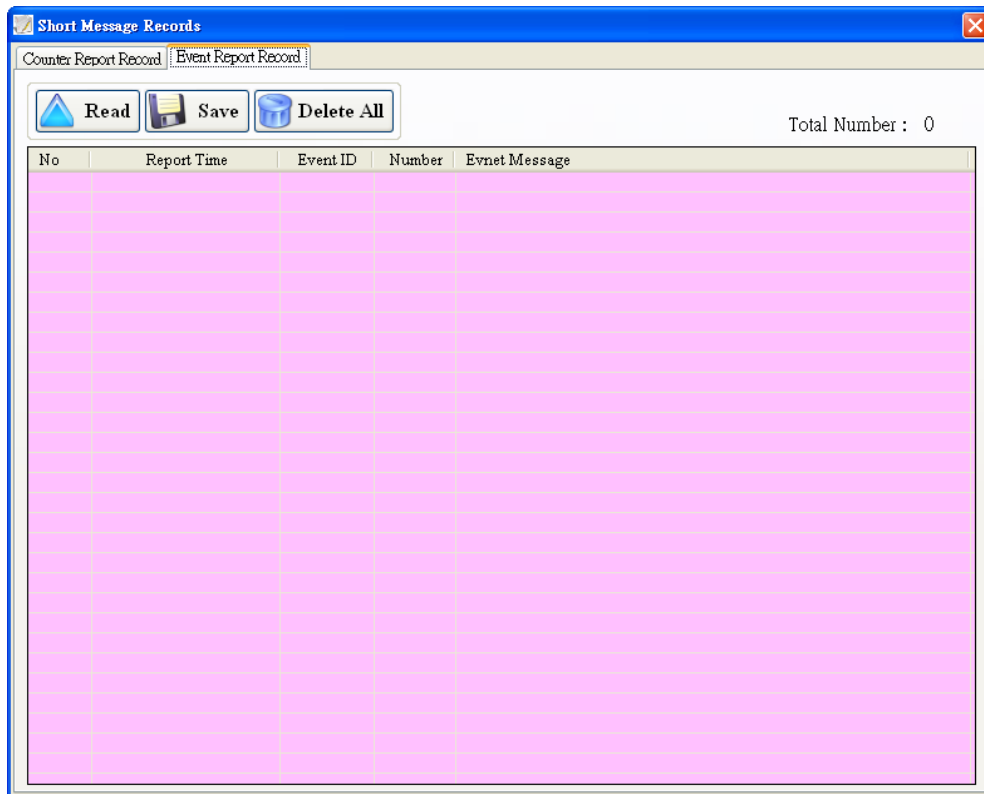

Operation:

- (1) Read: Read all the CRPT report from SMS-530. The maximum number of CRPT report records is 64.
- (2) Save: Save these records to a file.
- (3) Delete all: Delete all event report records of SMS-530.

Text field:

- (1) No.: Record number.
- (2) Report time: Event report time of SMS-530.
- (3) Event ID: Event identification.
- (4) Number: The SMS quantity sent to the defined phone numbers.
- (5) Event message: The event content.

## 4.6 Device Time

This window provides the function to inquire and modify the time of SMS-530. Besides, the next and last report times are also shown. The text field operation is below:



Text field:

- (1) Device time: show the time of SMS-530. Users also can change the time in this field to key in the specific time.
- (2) Next Counter Report Time: show the next CRPT time.
- (3) Last Counter report time: show the last CRPT time.

Operation:

- (1) Set as Now: Set the PC time to SMS-530. After setting the time successfully, the information of SMS-530 time and CRPT report time would be updated.
- (2) Set: Set the SMS-530 time according the "Device Time" field. After setting the time successfully, the information of SMS-530 time and CRPT report time would be updated.
- (3) Read: Read back the time of SMS-530, the next report time and the last report time.

Note:

If the counter report function is enable and reset the time of SMS-530, the next time to send the SMS report is re-calculated according to the current time of SMS-530 and the CRPT time. There would 2 conditions on the day:

- (1) When the SMS-530 time is over the CRPT time, SMS-530 would send the CRPT SMS after 30 seconds.
- (2) If the SMS-530 time does not reach the CRPT time, SMS-530 would not send the CRPT SMS until SMS-530 time reaches the CRPT time.

### 4.7 Counter Value

The window provides the function to inquire and modify the counter values of DI0 ~ DI5. The explanation of operation and text field is below:

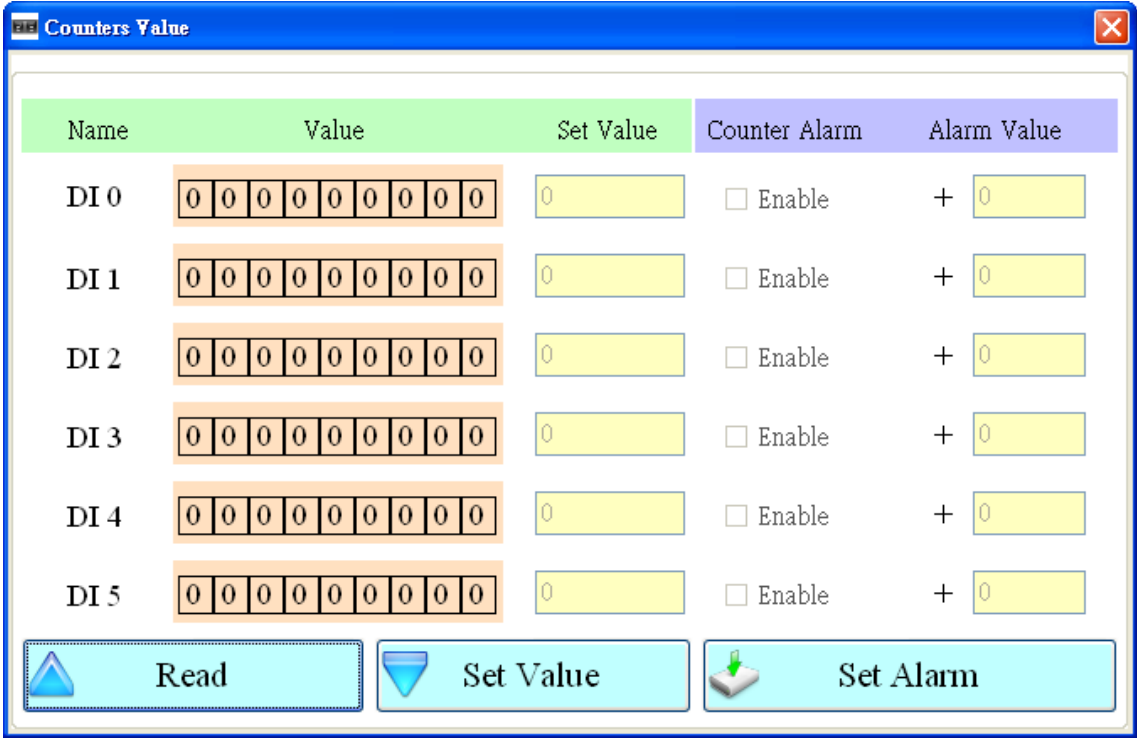

Text field:

- (1) Name: The DI name of DI0 ~ DI5.
- (2) Value: The current counter value (maximum: 999999999).
- (3) Set Value: Input the defined counter value. The maximum is 999999999. This field is enabled when DI is set as counter mode.
- (4) Counter Alarm: Enable the counter alarm.
- (5) Alarm Value: Counter alarm value = current value + alarm value. This field can not be 0.

Operation:

- (1) Read: Read the current counter value and alarm settings from SMS-530. If the counter is not set as counter, the counter value is 0.
- (2) Set Value: Change the counter value into SMS-530 according to the "Set Value" field.
- (3) Set Alarm: Set the counter alarm into SMS-530.

## 4.8 Change Password

This window provides the function of changing login password. The default password is “111111”. This password is also applied in SMS command to SMS-530. These SMS commands is described in chapter 5.

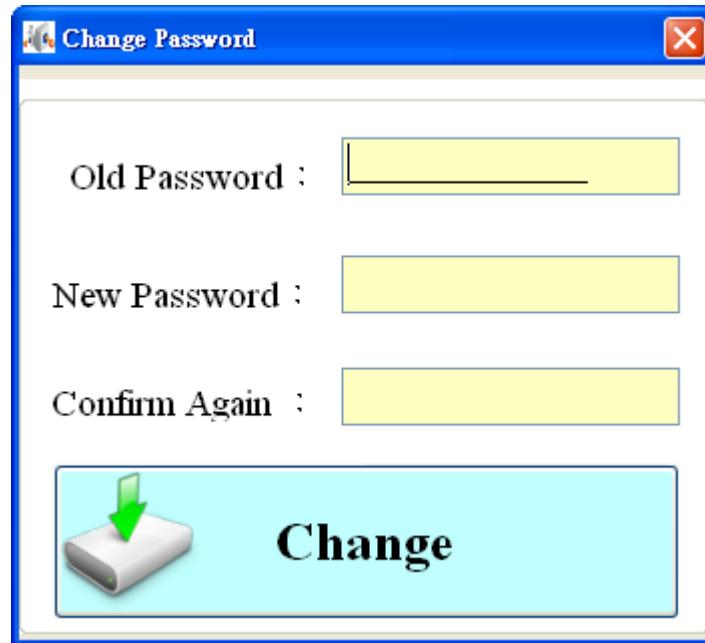

The screenshot shows a window titled "Change Password" with a blue border and a close button in the top right corner. Inside the window, there are three text input fields stacked vertically. The first is labeled "Old Password :", the second "New Password :", and the third "Confirm Again :". Below these fields is a large, light blue button with a green arrow icon pointing downwards and the word "Change" in bold black text.

Text field:

- (1) Old password: Input the current password.
- (2) New password: Input the new password (maximum : 12 characters)
- (3) Confirm Again: Input new password again.

Operation:

- (1) Change: Updated the password.

## 4.9 DO control/DI status

The function is used for controlling DO and reading the status of DIs:

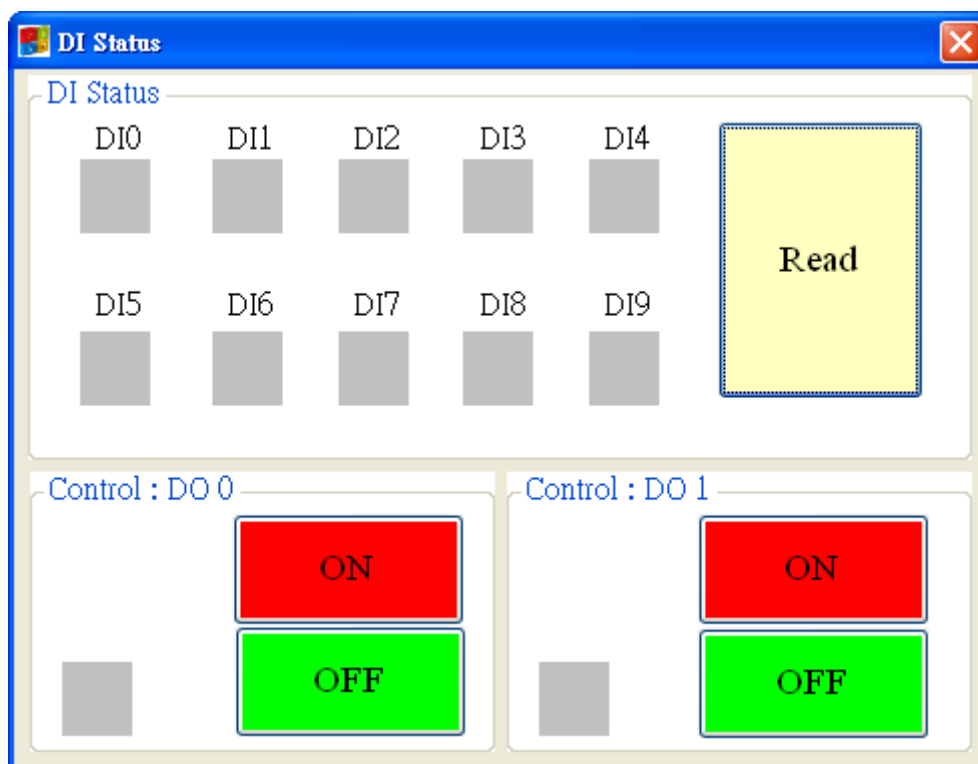

Text field:

- (1) DI0 ~ DI9、DO0 ~ DO1:
  - ◆ Grey: the voltage logic is high.
  - ◆ Red: the voltage logic is low.

Operation:

- (1) Read: Read back the status of DI0 ~ DI9 and DO0 ~ DO1 from SMS-530.
- (2) DO0 ~ DO1 ON: Set the DO output on
- (3) DO0 ~ DO1 OFF: Set the DO output off



## 4.10 Battery information

This function provides users to check the remaining volume of battery.

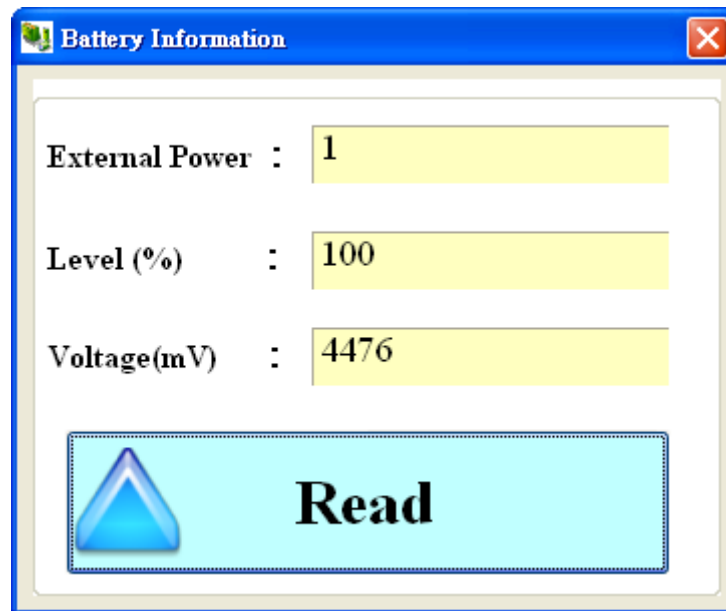

Text field:

- (1) External Power: The external power is on or off. (1-on, 0-off). It needs to open the external power when using utility to configure SMS-530.
- (2) Level: Show the percentage of battery volume. If the battery is not connected to SMS-530. The value is about 100%.
- (3) Voltage: The voltage value of battery. If the battery is not connected to SMS-530. The value is about 4480 mV.

Operation:

- (1) Read: Read the above information from SMS-530.

## 4.11 Signal Quality

This window can show 3G signal strength.

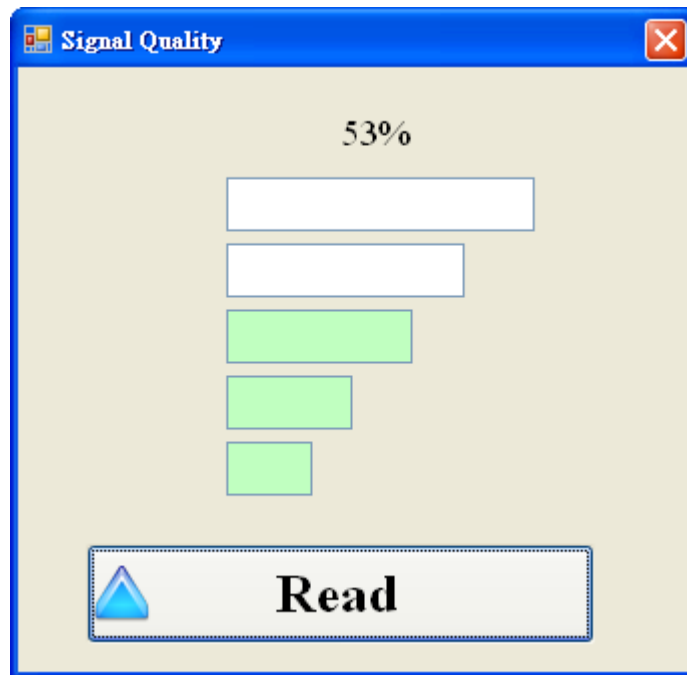

Text field:

- (1) The strength is divided into 5 sections shown in percentage.

Operation:

- (1) Read: Read the 3G signal strength.

## 4.12 Version

Press “Version” in tool menu, and the window would show the version of Utility and firmware.

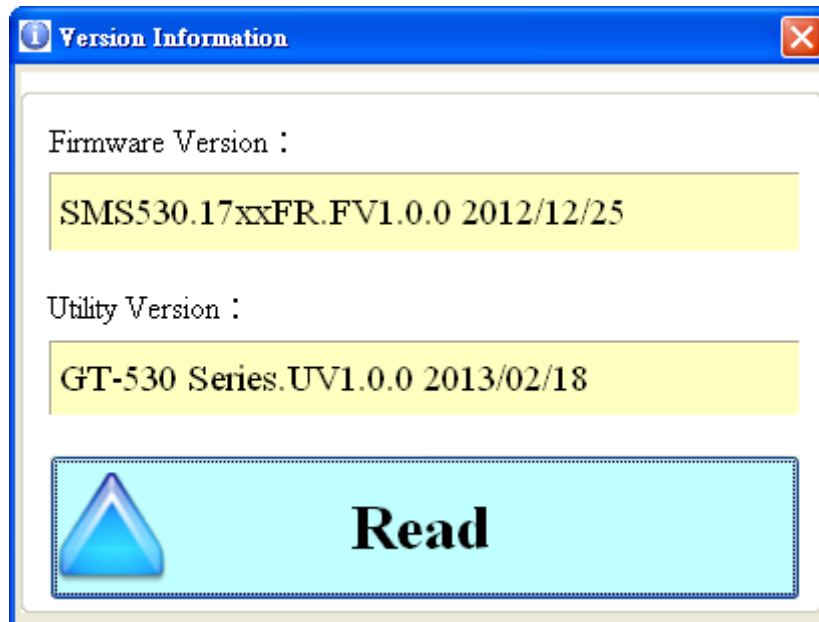

Text field:

- (1) Firmware version: show the version information of SMS-530's firmware.
- (2) Utility version: show the version information of SMS-530's utility.

Operation:

- (1) Read: Read these information from SMS-530.

## 4.13 System

“System” menu item has 2 functions of recovering factory setting and resetting SMS-530.

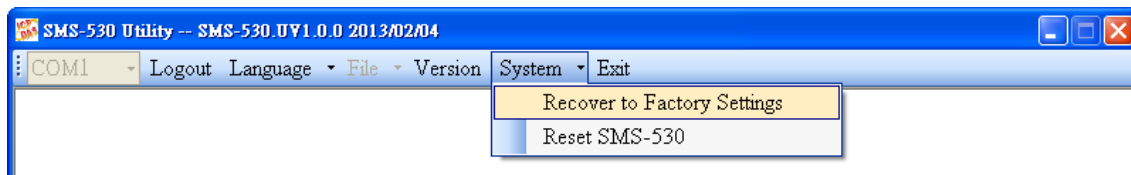

### 4.13.1 Recover to Factory Settings

The function is used to recover SMS-530 as factory settings including password. The steps are below:

- (1) Connect COM3.TX and COM3.RX.
- (2) Make sure the STA led is blanking per 1 sec.
- (3) Select the Recover to Factory Settings.

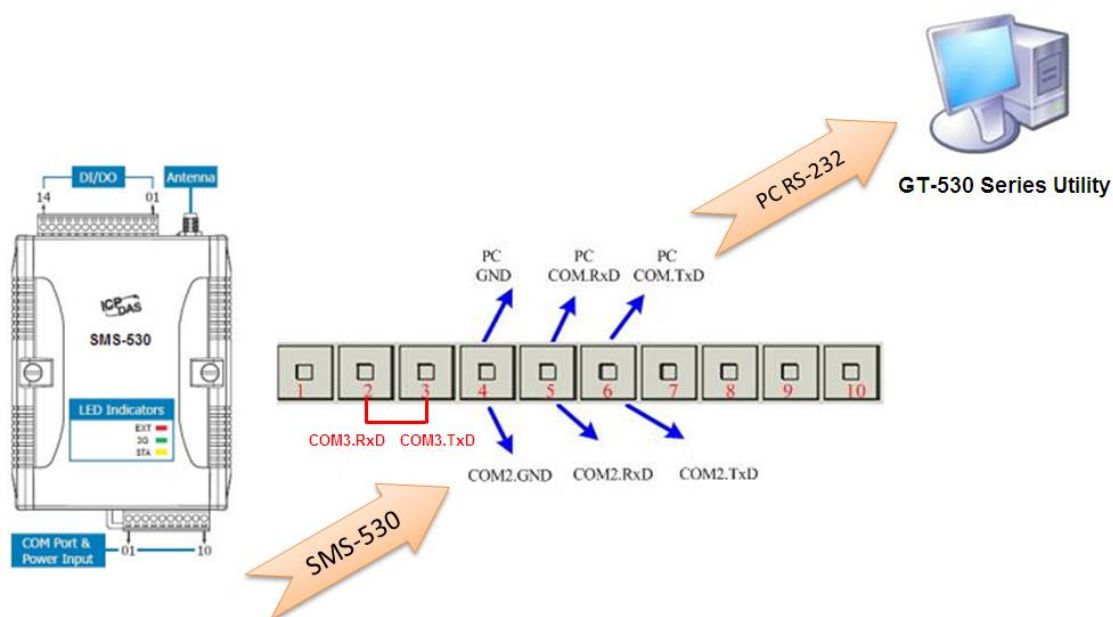

### 4.13.2 Reset SMS-530

The function is used to reset SMS-530 by software.

- (1) Make sure STA led is blanking per 1 second.
- (2) Select “Reset SMS-530” button to reset SMS-530.

## 5. SMS Command

These SMS commands help users to control or get the information of SMS-530. SMS-530 can only receive these commands according to the phone numbers set in SMS-530. These phone numbers must be set to have “Allowed” authority. If the phone number is not in the list, SMS-530 would not reply to any command.

Command Table

SMS command	Description
@TIME	Time set and inquiry
@DOCn	DO control
@ACTV	Counter value inquiry
@DIV	DI/DO inquiry
@BAT	Battery inquiry
@PASS	Password inquiry
@CRPT	Send Counter Report SMS to all phone number

## 5.1 @TIME (Time set and inquiry)

### (1) Description

This command is used to set or inquire the time of SMS-530.

### (2) Request

#### Set

@TIME;Password;YYYYMMDD;HHMMSS

#### Inquiry

@TIME;Password

#### Format

Password: Login password

YYYYMMDD: YYYY=year, MM=month, DD=day

HHMMSS: HH=hour, MM=minute, SS=second

#### Example

Set the time as 2013/02/06 10:03:00:

@TIME;000000;20130206;100300

Inquiry the time:

@TIME;000000

### (3) Response

!MID;TIME;Result;YYYYMMDD;HHMMSS

#### Format

MID: Machine ID

TIME: Command name

Result: Command result

- ◆ OK → Command is OK
- ◆ NO → Password is wrong
- ◆ ER → The format is wrong or authority is not allowed

YYYYMMDD: YYYY=year, MM=month, DD=day

HHMMSS: HH=hour, MM=minute, SS=second

#### Example

!SMS-530;TIME;OK; 20130206;100300

## 5.2 @DOCn (DO control)

### (1) Description

Set DO0 and DO1 output.

### (2) Request

#### Command

@DOCn;Password;CMD;Second

#### Format

n: 0 ~ 1 (0-DO0, 1-DO1)

Password: Login password

CMD:

- ◆ ON → Set DO on
- ◆ OFF → Set DO off
- ◆ PLUS → The DO channel is set to on during the defined time.

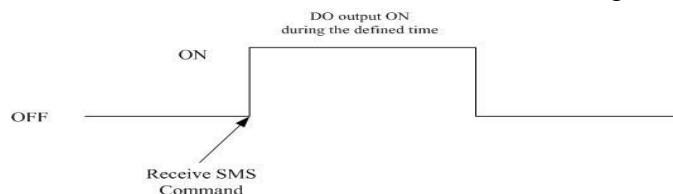

Second: The command is used for PLUS mode. (0~999 seconds)

#### Example

Set DO1 output to on:

@DOC1;000000;ON

Set DO1 output to on during 20 seconds:

@DOC1;000000;PLUS;20

### (3) Response

!MID;DOCn; Result; CMD;Second

#### Format

MID: Machine ID

DOC: Command name

n: 0 ~ 1 (0- DO0, 1-DO1)

Result: command result

- ◆ OK → Command is successfully
- ◆ NO → The password is wrong
- ◆ ER → The format is wrong or authority is not allowed

CMD、Second:

The same as the above description.

#### Example

!SMS-530;DOC1;OK;ON

!SMS-530;DOC1;OK;PLUS;20

---

## 5.3 @ACTV (Counter value inquiry)

### (1) Description

Inquire the counter values of DI0 ~ DI5.

### (2) Request

#### Inquire

@ACTV;Password

#### Format

Password: Login password

#### Example

Inquire the 6 current counter values of SMS-530:

@ACTV;000000

### (3) Response

!MID;ACTV;Result;DI0;DI1;DI2;DI3;DI4;DI5

#### Format

MID: Machine ID

ACTV: Command name

Result: Command result

- ◆ OK → No error
- ◆ NO → The password is wrong
- ◆ ER → The format is wrong or authority is not allowed

DI0: The DI0 counter value. If the DI is not set as counter, the value is 0.

DI1: The DI1 counter value. If the DI is not set as counter, the value is 0.

DI2: The DI2 counter value. If the DI is not set as counter, the value is 0.

DI3: The DI3 counter value. If the DI is not set as counter, the value is 0.

DI4: The DI4 counter value. If the DI is not set as counter, the value is 0.

DI5: The DI5 counter value. If the DI is not set as counter, the value is 0.

#### Example

!SMS-530;ACTV;OK;3;3;3;3;3;3



---

## 5.4 @DIV (DI/DO inquiry)

### (1) Description

Inquiry the status of 10 DI and 2 DO.

### (2) Request

#### Inquiry

@DIV; Password

#### Format

Password: Login password

#### Example

Inquiry the status of 10 DI and 2 DO:

@DIV;000000

### (3) Response

!MID;DIV; Result;DI0;DI1;DI2;DI3;DI4;DI5;DI6;DI7;DI8;DI9;DO0;DO1

#### Format

MID: Machine ID

DIV: Command name

Result: Command result

- ◆ OK → Command successfully
- ◆ NO → The password is wrong
- ◆ ER → The format is wrong or authority is not allowed

DI0~DI9: The status of DI channels

- ◆ 1 → Low Voltage
- ◆ 0 → High Voltage

DO0 ~ DO1: The status of DO channels

- ◆ 1 → High Voltage
- ◆ 0 → Low Voltage

#### Example

!SMS-530;DIV;OK;0;0;0;0;0;0;0;0;0;0;0;1;0

## 5.5 @BAT (Battery inquiry)

### (1) Description

This command is to inquire the information of battery.

### (2) Request

#### Inquiry

@BAT;Password

#### Format

Password: Login password

#### Example

Inquire the information of battery:

@BAT;000000

### (3) Response

!MID;BAT;Result;Pext;Percent;Voltage

#### Format

MID: Machine ID

BAT: Command name

Result: Command result

- ◆ OK → Command successfully
- ◆ NO → The password is wrong
- ◆ ER → The format is wrong or authority is not allowed

Pext: The status of the external power

- ◆ 0 → OFF
- ◆ 1 → ON

Percent: The percentage of battery volume (%)

Voltage: The voltage value of battery (mV)

#### Example

!SMS-530;BAT;OK;0;57;3899

## 5.6 @PASS (Password inquiry)

### (1) Description

If you forget the password, you can use this command to inquire password. The phone number must be set the authority of "SMS Command".

### (2) Request

#### Inquiry

@PASS

#### Example

Inquire the password of SMS-530:

@PASS

### (3) Response

!MID;PASS;Result;Password;Password

#### Format

MID: Machine ID

PASS: Command name

Result: Command result

◆ OK → Inquire successfully

◆ ER → No authority

Password: the current password

#### Example

!SMS-530;PASS;OK;111111;111111

---

## 5.7 @CRPT (Send Counter Report SMS to all phone number)

### (1) Description

Send Counter Report SMS to all phone number.

### (2) Request

#### Inquire

@CRPT;Password

#### Format

Password: Login password

#### Example

Send Counter Report SMS to all phone number:

@CRPT;000000

### (3) Response

CRPT;MID;Report Data;Report Time;DI0;DI1;DI2;DI3;DI4;DI5

#### Format

CRPT: Counter report

MID: Machine ID

Report Date: Report date (The format is YYYYMMDD)

Report Time: Report time (The format is HHMMSS)

DI0: The DI0 counter value. If the DI is not set as counter, the value is 0.

DI1: The DI1 counter value. If the DI is not set as counter, the value is 0.

DI2: The DI2 counter value. If the DI is not set as counter, the value is 0.

DI3: The DI3 counter value. If the DI is not set as counter, the value is 0.

DI4: The DI4 counter value. If the DI is not set as counter, the value is 0.

DI5: The DI5 counter value. If the DI is not set as counter, the value is 0.

#### Example

CRPT;SMS-530;20140303;153000;3;3;3;3;3;3

---

## 6. Send/Receive SMS by COM 3

SMS-530 provides sending/receiving SMS function from COM 3. This function can provide PLC or PAC to send or receive SMS through SMS-530. That can extend SMS-530 to various applications.

COM port setting:

- ◆ Baud rate: 9600 bps
- ◆ Data bit: 8
- ◆ Parity check: none
- ◆ Stop bit: 1
- ◆ Flow control: none

### 6.1 Send data to COM port of SMS-530 by SMS command

It is possible to use SMS to send data to com port of SMS-530. The command header is “+++”. The first setting phone number just has the authority to use this function with the “Allowed” enabling. The command support 7 Bits format.

#### Command

+++Message

Message: The message is sent to com3 of SMS-530 (Maximum 130 char)

#### Example

SMS content : +++Hello

To COM 3 : Hello

### 6.2 Send SMS by COM 3

This function is used to send SMS to the first setting phone number by this command “+++”. This command supports ASCII code, not Unicode.

#### Request

+++Message

Message: The user-defined SMS content, and the end of the message have to add ASCII code 0x0d.

#### Example

Command from COM 3 : +++Hello

Received SMS content : Hello

## 7. Troubleshooting

Item	Trouble state	Solution
1	EXT LED is off without Li-battery	Please check the external power and wire connection.
2	STA is always on	<ol style="list-style-type: none"> <li>1. Check SIM card</li> <li>2. Check Antenna</li> <li>3. Check the 3G signal strength</li> </ol>
3	GT-530 Series Utility can not connect to SMS-530	<ol style="list-style-type: none"> <li>1. Check STA LED blinking every 1 sec</li> <li>2. Check com port connection and baud rate setting</li> </ol>
4	After event triggering, users can not receive SMS	<ol style="list-style-type: none"> <li>1. Check DI connection</li> <li>2. Check phone number and format</li> <li>3. Check DI event is enabled in GT-530 Series Utility</li> </ol>
5	Counter value is abnormal	<ol style="list-style-type: none"> <li>1. Check wire connection</li> <li>2. Check the counter signal is at 5~40Hz</li> <li>3. Check the DI mode setting. Must be counter mode.</li> </ol>
6	The content of received SMS is abnormal	Please select the correct language to set the content of SMS in utility. If you want to transfer Unicode char, select the language supporting UCS2.
7	The time of receiving SMS is abnormal	<ol style="list-style-type: none"> <li>1. The time in SMS-530 is abnormal. Setup the time of SMS-530 by utility.</li> <li>2. The battery of RTC is low. Change the silver battery of RTC. After changing the battery, set the time of SMS-530.</li> </ol>
8	STA led is blanking per 50 ms	The pin code is wrong. The login windows would show the field to input PIN or PUK code.
9	Forget Password	Use SMS command to get the password.

## 8. Revision History

Revision	Date	Author	Description
1.0	2013/04/02	William	Release version
1.1	2015/02/11	William	Add @CRPT SMS command