

# PIR-230-E Quick Start

Nov. 2016  
Version 1.0.0

## 1

### Package Contents



PIR-230-E  
Module



Mounting Plate

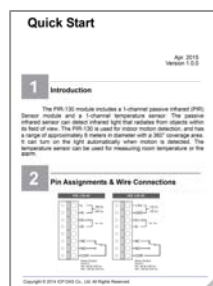

Quick Start



M4x12 Drywall  
Screws x 2

## 2

### Wire Connections

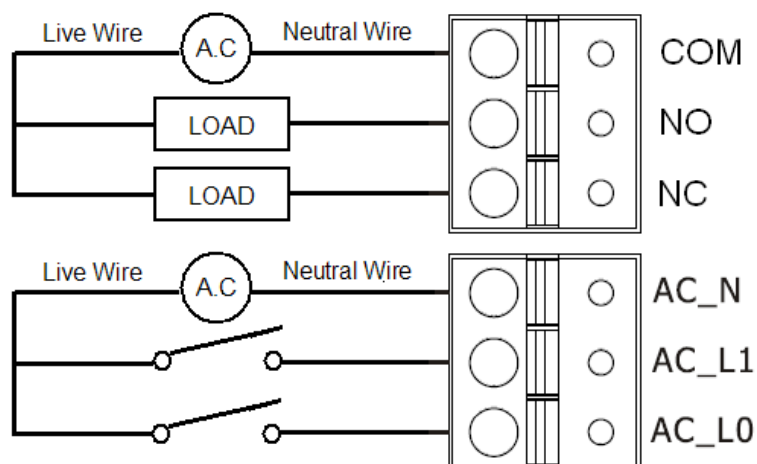

# 3

## Installation

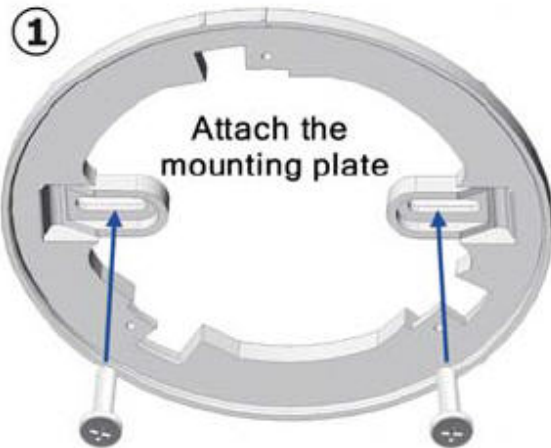

# 4

## Switch Setting

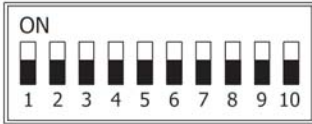

Function		Switch Number and Setting									
		1	2	3	4	5	6	7	8	9	10
Protocol	Modbus	OFF	---	---	---	---	---	---	---	---	---
	DCON	ON	---	---	---	---	---	---	---	---	---
Configuration	Hardware	---	OFF	---	---	---	---	---	---	---	---
	Software	---	ON	---	---	---	---	---	---	---	---
Address	Low Node	---	---	OFF	---	---	---	---	---	---	---
	High Node	---	---	ON	---	---	---	---	---	---	---
Mode	Normal	---	---	---	OFF	---	---	---	---	---	---
	INIT	---	---	---	ON	---	---	---	---	---	---
PIR Operating	Dawn	---	---	---	---	OFF	---	---	---	---	---
	Dust	---	---	---	---	ON	---	---	---	---	---
Sensitivity	Maximum	---	---	---	---	---	OFF	OFF	---	---	---
	High	---	---	---	---	---	OFF	ON	---	---	---
	Low	---	---	---	---	---	ON	OFF	---	---	---
	Minimum	---	---	---	---	---	ON	ON	---	---	---
ON Time Control (Seconds)	6	---	---	---	---	---	---	---	OFF	OFF	OFF
	16	---	---	---	---	---	---	---	OFF	OFF	ON
	33	---	---	---	---	---	---	---	OFF	ON	OFF
	66	---	---	---	---	---	---	---	OFF	ON	ON
	131	---	---	---	---	---	---	---	ON	OFF	OFF
	262	---	---	---	---	---	---	---	ON	OFF	ON
	524	---	---	---	---	---	---	---	ON	ON	OFF
1049	---	---	---	---	---	---	---	ON	ON	ON	

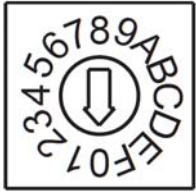
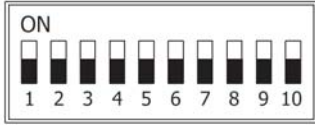
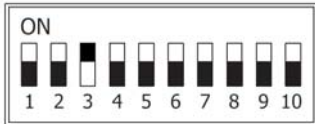
		<p>When <b>DIP3=OFF</b>          Rotary Switch 0 ~ F for          Node Addresses 160~175          (Low Node Address)</p>
		<p>When <b>DIP3=ON</b>          Rotary Switch 0 ~ F for          Node Addresses 176~191          (High Node Address)</p>

# 5

## Technical Support

- User Manual and Utility  
[http://ftp.icpdas.com/pub/cd/pir/PIR-230-E/pir-230-e\\_index.html](http://ftp.icpdas.com/pub/cd/pir/PIR-230-E/pir-230-e_index.html)
- Product Website  
[http://www.icpdas.com/root/product/solutions/remote\\_io/rs-485/sensor\\_series/pir-230.html](http://www.icpdas.com/root/product/solutions/remote_io/rs-485/sensor_series/pir-230.html)
- E-mail  
[service@icpdas.com](mailto:service@icpdas.com)