

工業級 4G 數據機

GTM-204M 系列

使用者手冊

Version 1.3.0 March 2018



## 保固說明

---

泓格科技股份有限公司 (ICP DAS) 所生產的產品，均保證原始購買者對於有瑕疵之材料，於交貨日起保有為期一年的保固。

## 免責聲明

---

泓格科技股份有限公司對於因為應用本產品所造成的損害並不負任何法律上的責任。本公司保留有任何時間未經通知即可變更與修改本文件內容之權利。本文所含資訊如有變更，恕不予另行通知。本公司盡可能地提供正確與可靠的資訊，但不保證此資訊的使用或其他團體在違反專利或權利下使用。此處包涵的技術或編輯錯誤、遺漏，概不負其法律責任。

## 版權所有

---

2017 © 泓格科技股份有限公司版權所有。

## 商標識別

---

本文件提到的所有公司商標、商標名稱及產品名稱分別屬於該商標或名稱的擁有者所有。

### 技術服務

如有任何問題，請與本公司客服聯絡，我們將盡速為您服務。

E-mail 信箱：[service@icpdas.com](mailto:service@icpdas.com)

## 符號說明

---



### **RoHS**

本公司提供的所有無鉛產品皆符合歐盟有害物質使用限制指令(RoHS)，意即本公司的生產流程與產品均嚴格遵守無鉛守則，而且不包含該指令內提供的任何有害物質



### **WEEE**

此劃叉的滾輪垃圾筒圖示表示在歐盟境內，本產品於丟棄時必須另行收集。此原則適用於您的產品與任何標有此圖示的週邊設備。請勿隨意丟棄這些產品。請洽詢您當地的經銷商，以得知回收此設備的程序



### **HOT SURFACE DO NOT TOUCH**

此符號用於警告使用者，產品外殼可能處於高溫狀態，在外殼冷卻以前，請勿觸摸，否則可能會被燙傷



### **USB**

本產品支援 USB 2.0

---

---

# 目錄

<b>1. 簡介</b> .....	<b>2</b>
<b>2. 硬體規格</b> .....	<b>3</b>
<b>3. 硬體外觀</b> .....	<b>5</b>
3.1 GTM-204M-4G 外觀視圖.....	5
3.2 腳位定義 .....	5
3.3 LED 指示燈.....	6
<b>4. I/O 接線圖</b> .....	<b>7</b>
4.1 重置腳位接線方式.....	7
4.2 安裝方式 .....	8
4.3 快速測試 .....	9
4.3.1 硬體安裝.....	9
4.3.2 軟體安裝 (超級終端機).....	10
<b>5. GPRS 連線</b> .....	<b>15</b>
5.1 XPAC-8000 (Microsoft Windows XP) .....	15
5.1.1 GTM-204M-4G 硬體需求.....	15
5.1.2 建立新數據機.....	16
5.1.3 建立新網路連線 .....	22
<b>6. USB 驅動程式安裝</b> .....	<b>30</b>
6.1 XPAC-8000 (Microsoft Windows XP) .....	30
<b>7. Revision History</b> .....	<b>38</b>

# 1. 簡介

GTM-204M-4GE 是一款具有 USB 及 RS-232 介面的工業級 M2M 數據機。支援 FDD LTE B1/B3/B5/B7/B8/B20 和 WCDMA 850/900/2100 MHz 和 GSM 850/900/1800/1900 MHz 頻段。GTM-204M-4GE 利用便利的 2G/3G/4G 網路來監控遠端設備、各種流量計或即時的遠端控制。內建 TCP/IP stack，只需搭配簡單的控制命令即可連線上網。GTM-204M-4GE 的特色在於支援標準 AT 指令，可以輕易搭配多種 PLC 和 PC 來實現簡訊的收送和 4G/3G/GPRS 連線。

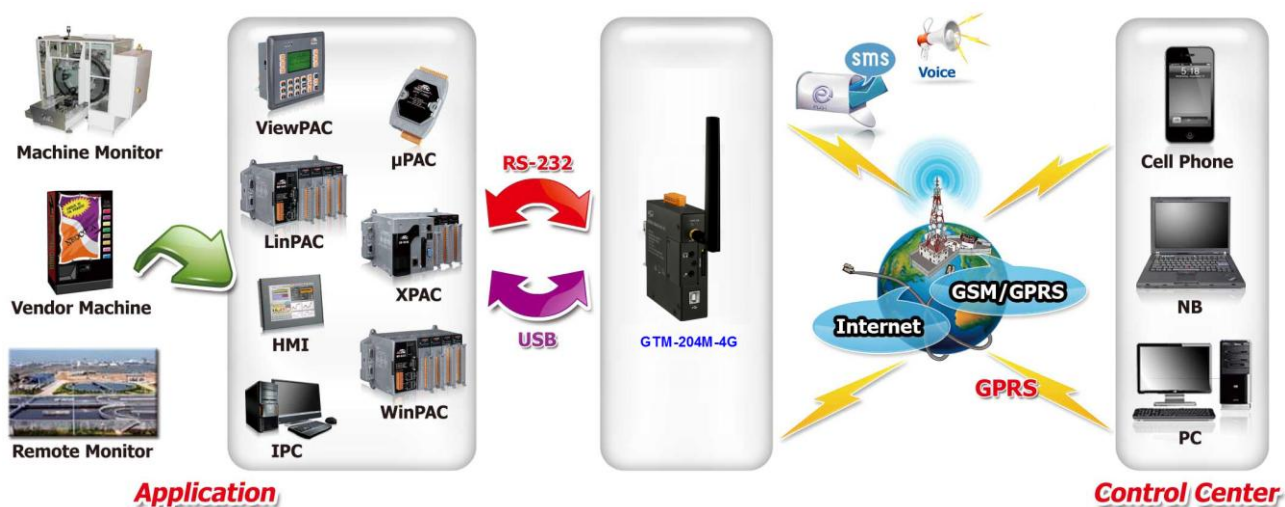

## 2. 硬體規格

型號	GTM-204M-4GE	GTM-204M-4GC
<b>GSM / GPRS 系統</b>		
頻段	850/900/1800/1900 MHz	900/1800MHz
GPRS 連結	GPRS class 12; GPRS station class B	
DATA GPRS	Downlink transfer: Max. 85.6 kbps; Uplink transfer: Max 42.8kbps	
<b>3G 系統</b>		
頻段 (MHz)	WCDMA 850/900/2100	WCDMA 900/2100 TD-SCDMA 1900/2100 CDMA2000 (BC0) 800
Data Transmission	DC-HSPA+ Download: Max. 42 Mbps; Upload: Max 5.76Mbps TD-SCDMA Download: Max. 4.2 Mbps; Upload: Max 2.2Mbps CDMA2000 EVDO Download: Max. 14.7 Mbps; Upload: Max 5.4Mbps	
<b>4G 系統</b>		
頻段	FDD LTE: B1/B3/B5/B7/B8/B20	FDD LTE: B1/B3/B8 TDD LTE: B38/B39/B40/B41
Data Transmission	Download Max 100Mbps / Upload Max 50Mbps	
<b>SMS</b>		
SMS	MT, MO, CB, Text, and PDU mode	
<b>Comm. 介面</b>		
COM Port	RxD, TxD, GND	
COM Port Baud Rate	9600 bps ~ 115200 bps (default : 115200 bps)	
USB	USB 2.0 (high speed)	
USB Driver Support	Windows XP/7/8/10, Windows Server 2012	
<b>LED 指示燈</b>		
電源	紅色	
3G/GSM	綠色	
<b>電源</b>		
保護	Power reverse polarity protection (極性反接保護)	
接地保護框架	ESD, Surge, EFT, Hi-Pot	
電源輸入範圍	+10 V <sub>DC</sub> ~ +30 V <sub>DC</sub>	
額定電流	30 ~ 15 mA / 10 ~ 30 V <sub>DC</sub>	
<b>重置輸入</b>		
輸入類型	Isolated, 3750 V <sub>rms</sub>	
開啟電壓	+3.5 V <sub>DC</sub> ~ +30V <sub>DC</sub>	
斷開電壓	+1 V <sub>DC</sub> max.	
輸入電阻	3 kΩ, 0.25W	
<b>機構</b>		

外殼	金屬
尺寸 (W x L x H)	28 mm x 78.5 mm x 100 mm
導軌	DIN-Rail
<b>環境</b>	
作業溫度	-25°C to 70°C
存放溫度	-40°C to 80°C
濕度	5~90% RH, non-condensing

### 3. 硬體外觀

#### 3.1 GTM-204M-4G 外觀視圖

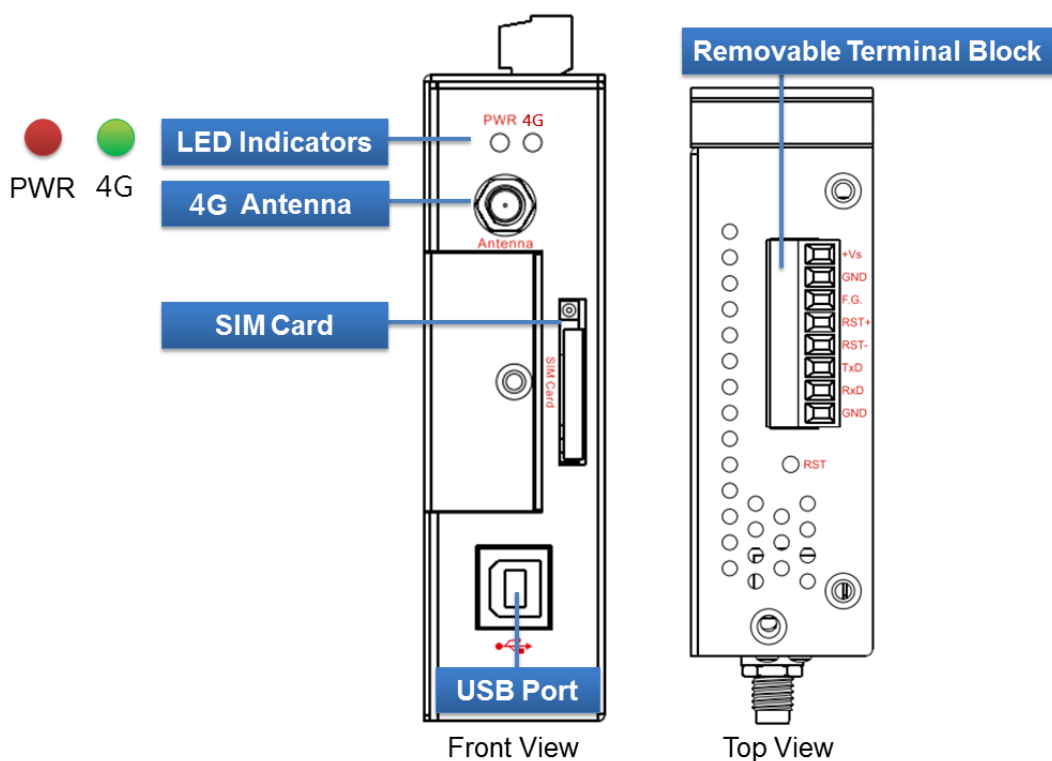

#### 3.2 腳位定義

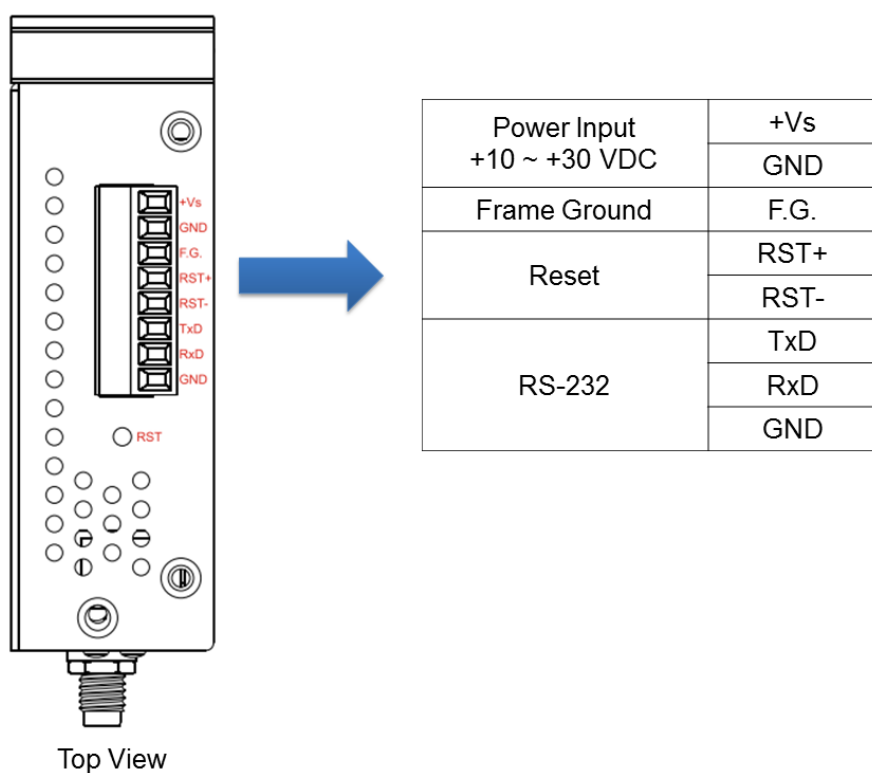



### 3.3 LED 指示燈

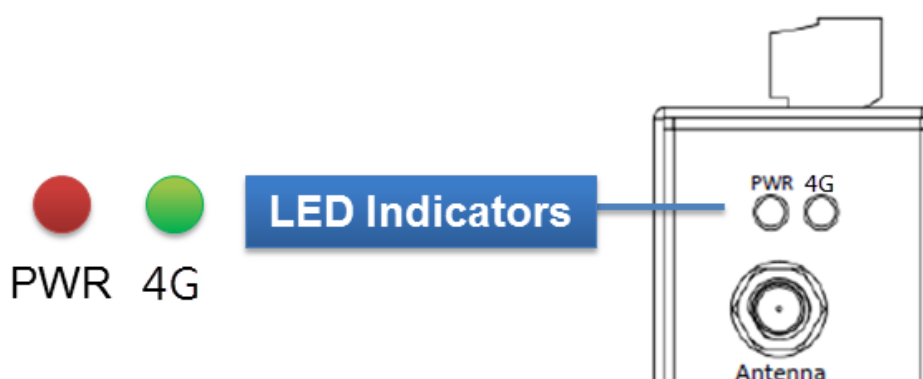

GTM-204M-4G 有 2 顆 LED 指示燈，幫助使用者判斷系統目前的狀態，其說明如下：

#### A. PWR(Red)：電源指示燈

電源正常	電源異常
恆亮	恆滅

#### B. 4G (Green)：顯示 4G 運作狀況

4G 模組正常	4G 模組異常	資料傳輸中
亮 2 秒滅 1 秒	不亮或亮 1 秒滅 2 秒	每 0.2 秒閃動一次

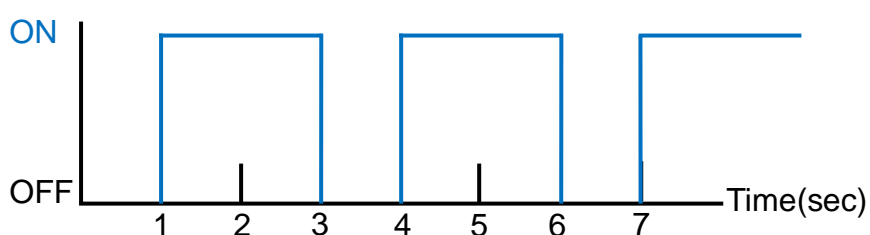

4G 模組正常

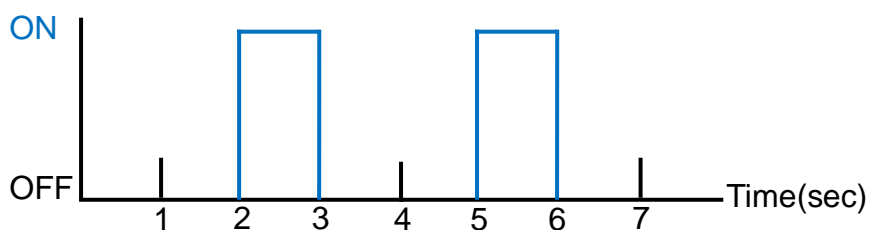

4G 模組異常

## 4. I/O 接線圖

### 4.1 重置腳位接線方式

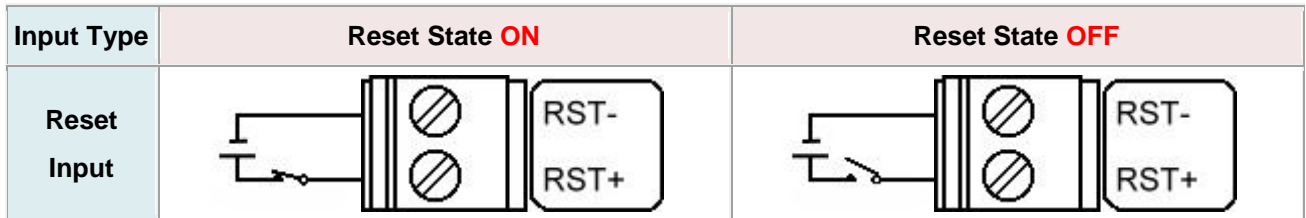

Reset Input	
<b>ON</b> Voltage Level	+3.5 V <sub>DC</sub> ~ +30 V <sub>DC</sub>
<b>OFF</b> Voltage Level	+1 V <sub>DC</sub> max.

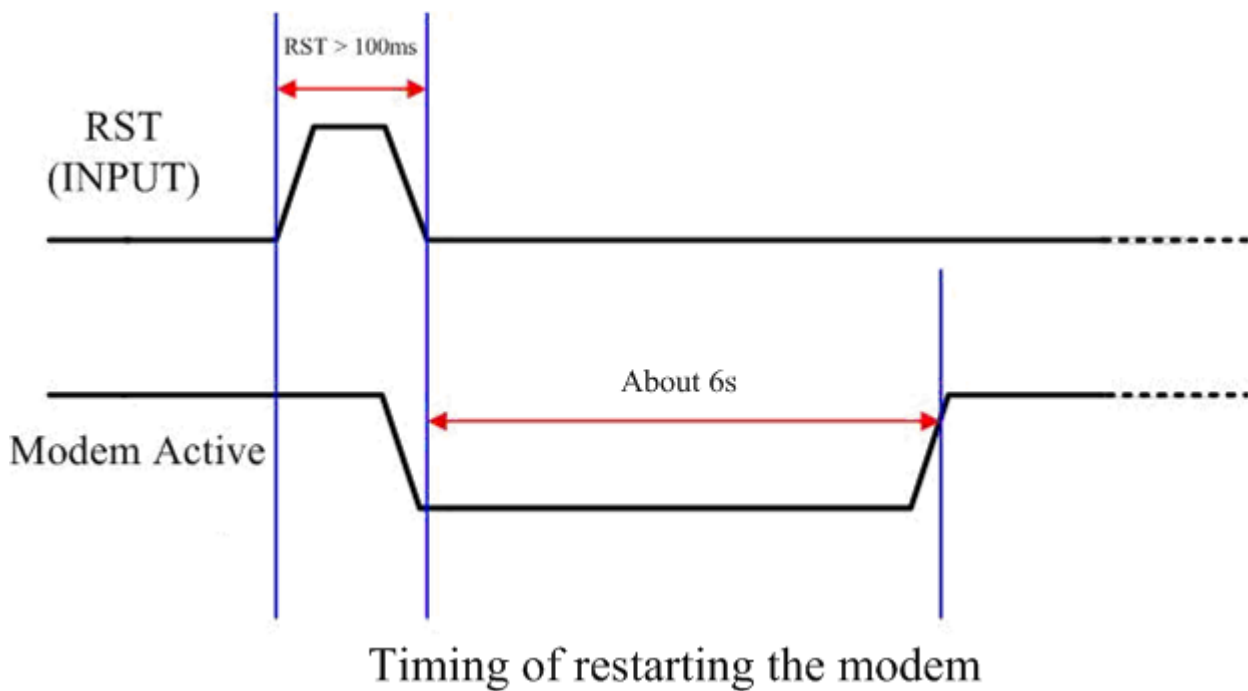

## 4.2 安裝方式

GTM-204M-4G 該由賦予適當授權的技術人員進行安裝，安裝的位置應該在一般人不會碰觸的地方。

### ➤ SIM 卡及天線安裝



### 警告! 表面發燙，請勿碰觸



產品外殼可能處於高溫狀態，在外殼冷卻以前，請勿觸摸，否則可能會被燙傷。

### 安全指令說明



此裝置的電源輸入腳位(DC.+VS/DC.GND)與直流電源(SELV，有限電源)連接時，應該要符合 EN60950-1 的要求。請務必確認接線是否正確。

## 4.3 快速測試

### 4.3.1 硬體安裝

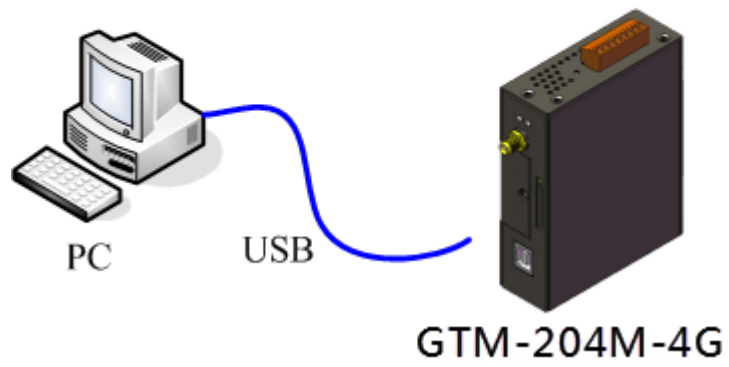

### 4.3.2 軟體安裝 (超級終端機)

步驟 1：開始 → 所有程式 → 附屬應用程式 → 通訊 → 超級終端機

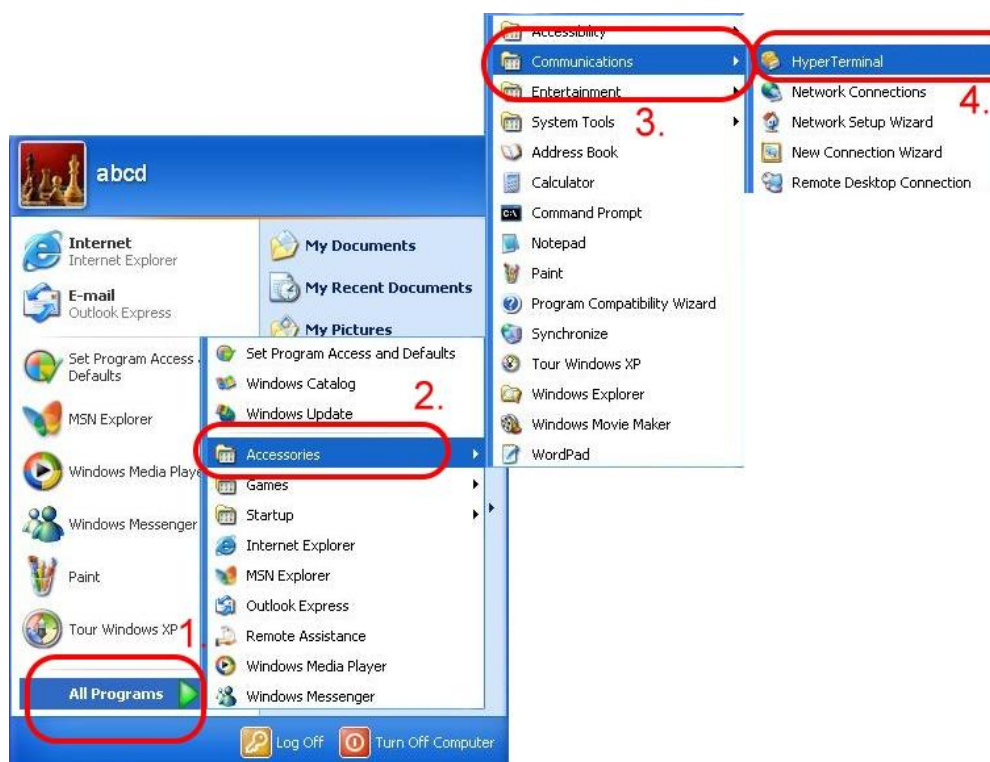

步驟 2：若跳出“Default Telnet Program?”的詢問視窗，請選擇“是”



步驟 3：輸入新的連線名稱 → 按“OK”

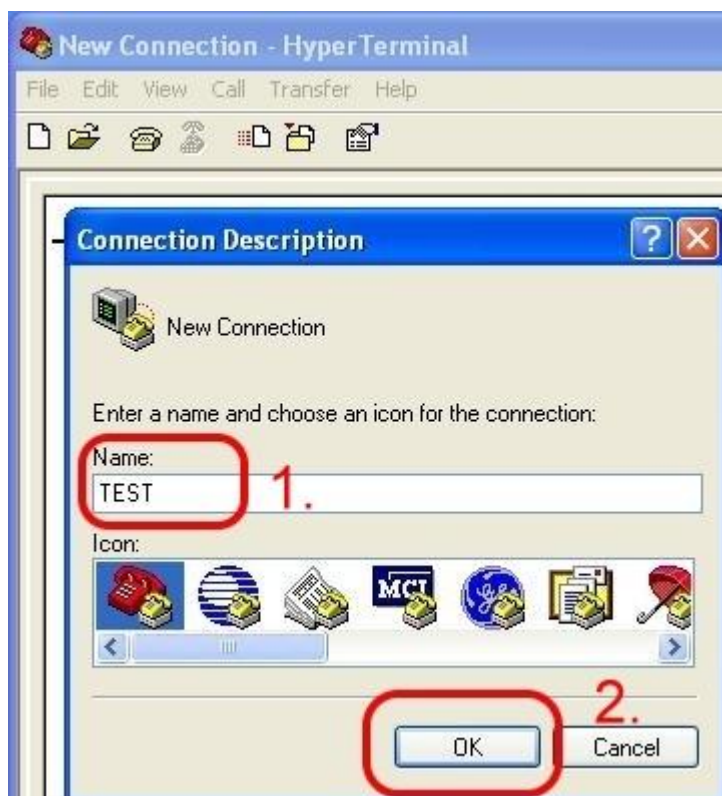

步驟 4：選擇電腦串列埠 → 按“OK”



步驟 5：請參考下列設定值

Bits per second	115200
Data bits	8
Parity	None
Stop bits	1
Flow control	None

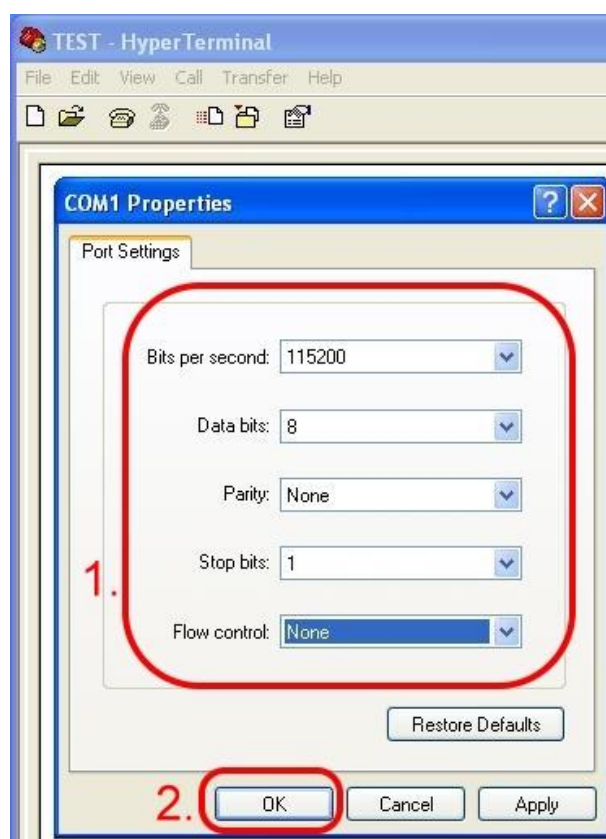

步驟 6：File → Properties



步驟 7：Settings → 點擊 “ASCII Setup…” 按鈕

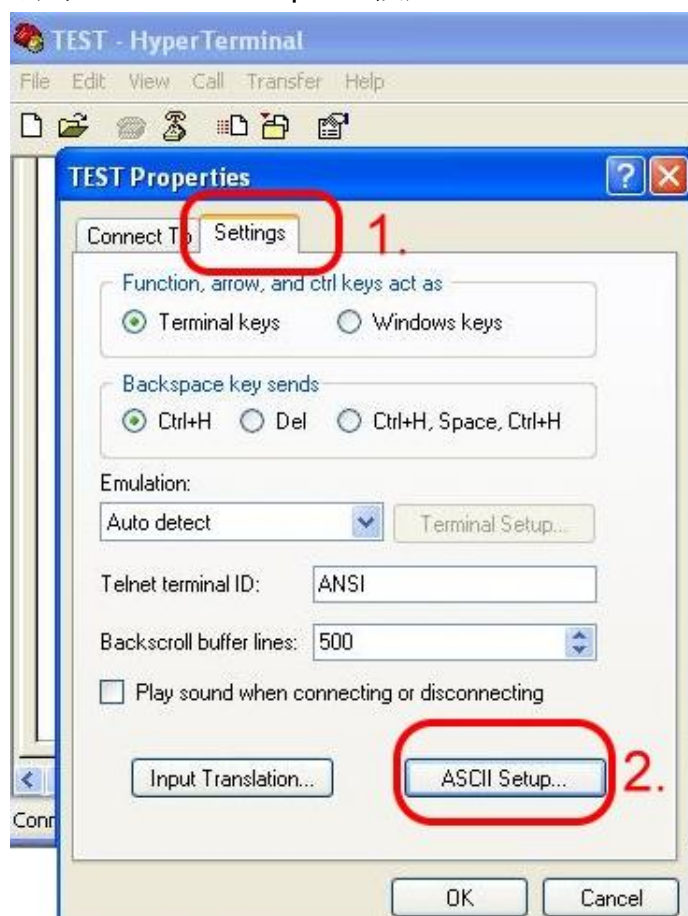

步驟 8：勾選 “Echo typed characters locally” → 按 “OK”

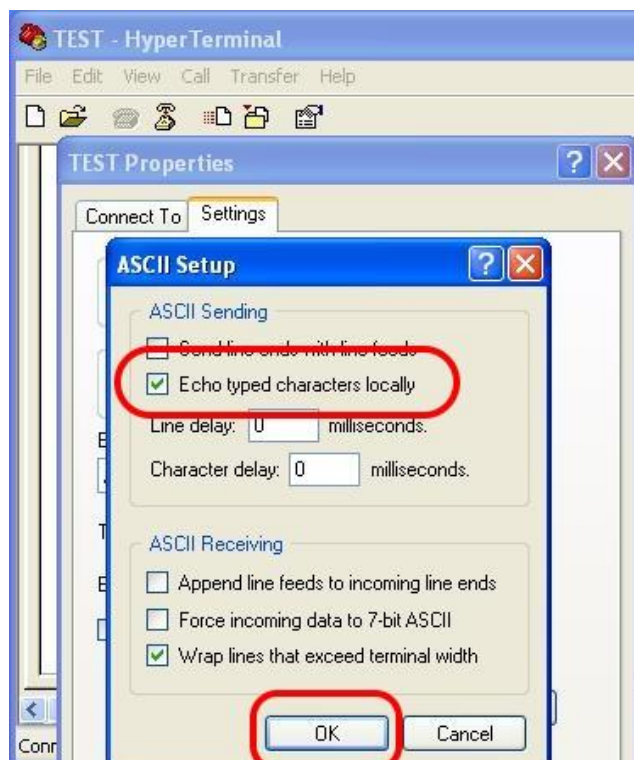



步驟 9：鍵盤輸入“AT”按“Enter”，會收到“AT OK”的回應



## 5. GPRS 連線

### 5.1 XPAC-8000 (Microsoft Windows XP)

#### 5.1.1 GTM-204M-4G 硬體需求

- A. GTM-204M-4G (請先安裝 USB 驅動程式)
- B. XPAC-8000
- C. USB cable



## 5.1.2 建立新數據機

步驟 1：Control Panel → 雙擊 “Phone and Modem Options”

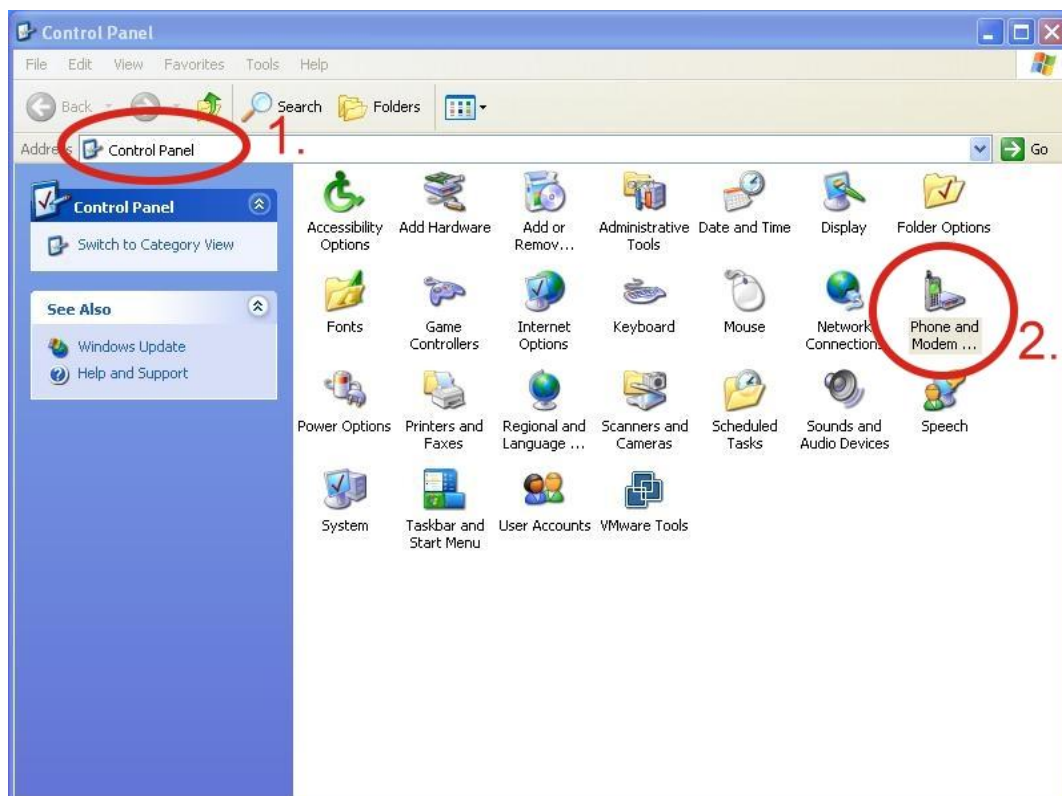

步驟 2：設定區碼 → 點擊 “OK”

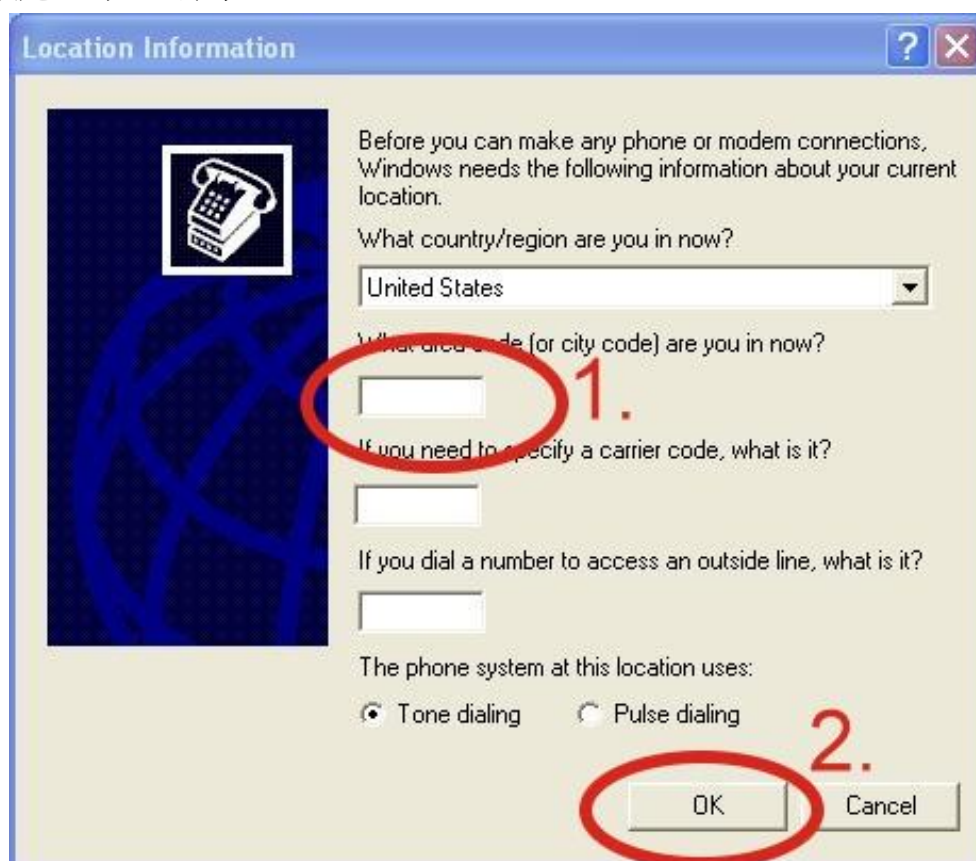

步驟 3：Control Panel → 雙擊 “Phone and Modem Options” → Modem → 點擊 “Add”



步驟 4：勾選 “Don't detect my modem; I will select it from a list.” → 點擊 “Next”



步驟 5：左邊欄位選取 “Standard Modem Types” → 右邊欄位選取 “Standard 19200 bps Modem” → 點擊 “Next”

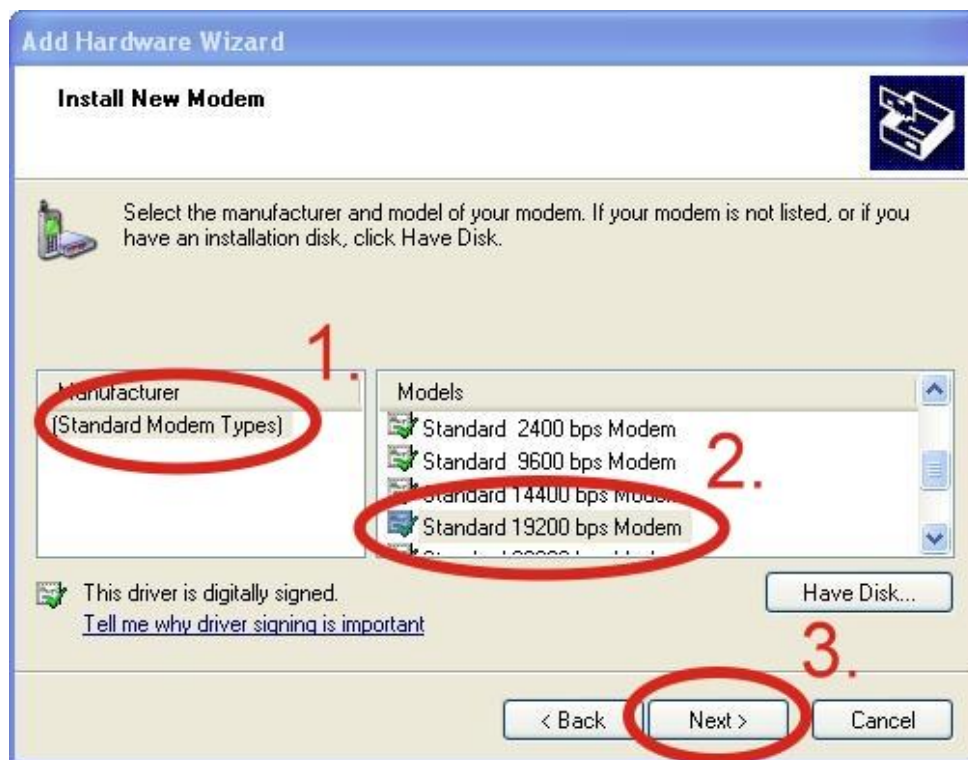

步驟 6：選取連接數據機的 COM Port → 點擊 “Next”

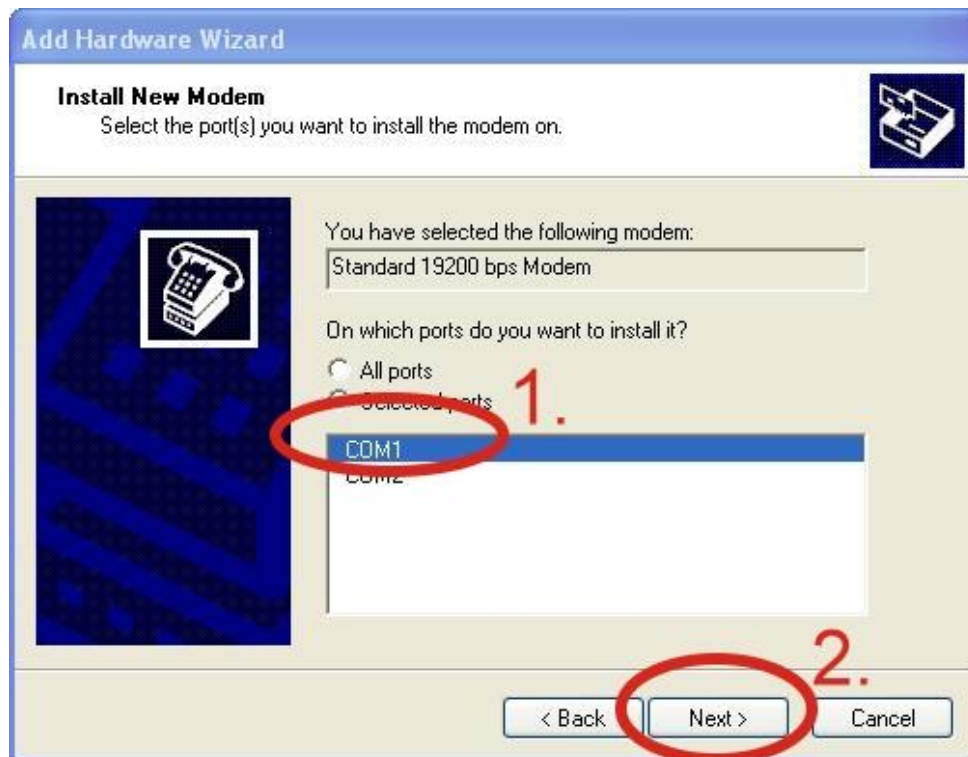

步驟 7：點擊 “Finish” 完成安裝



步驟 8：Control Panel → 雙擊 “Phone and Modem Options” → Modem → 選取 “Standard 19200 bps Modem” → 點擊 “Properties”

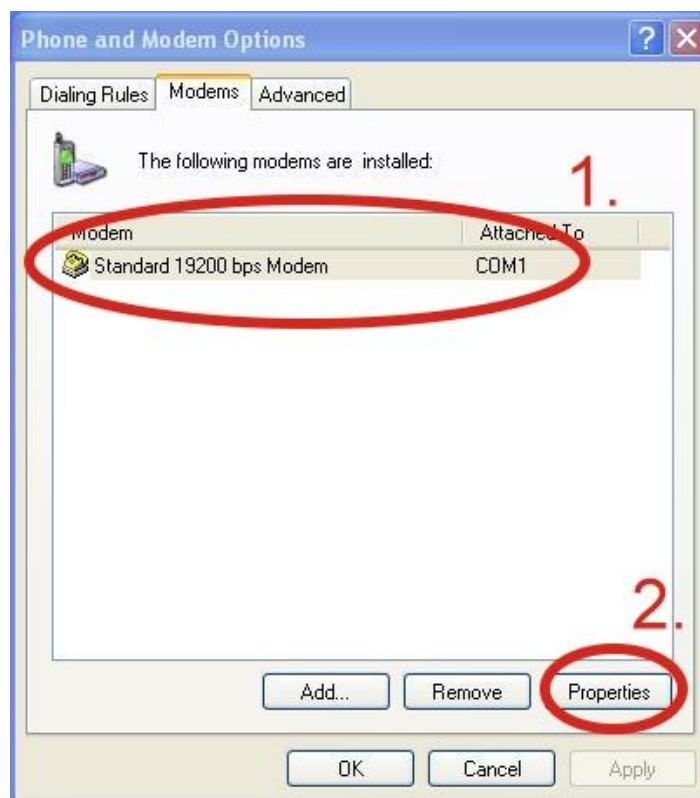

步驟 9：Modem → 於 Maximum Port Speed 欄位選取 115200

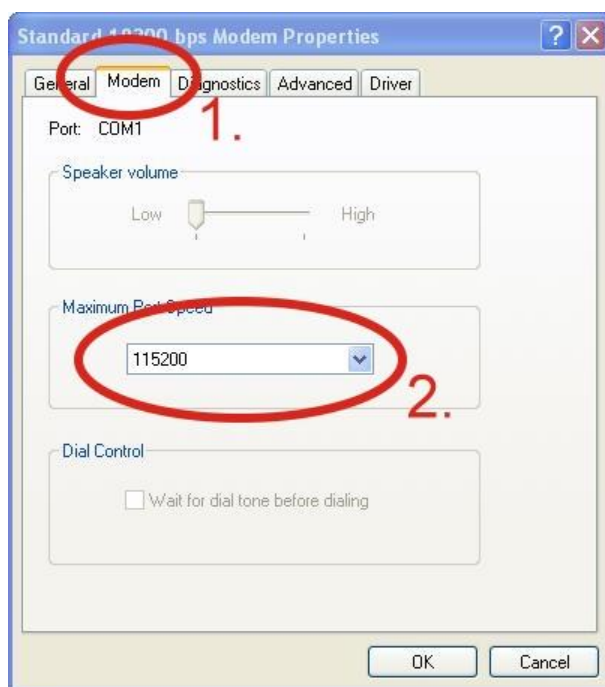

步驟 10：Advanced → 輸入額外的撥號指令

備註：GPRS 的 APN 由您當地的電信業者提供

在台灣輸入：AT+CGDCONT=1,"IP","INTERNET"

在大陸輸入：AT+CGDCONT=1,"IP","CMNET"

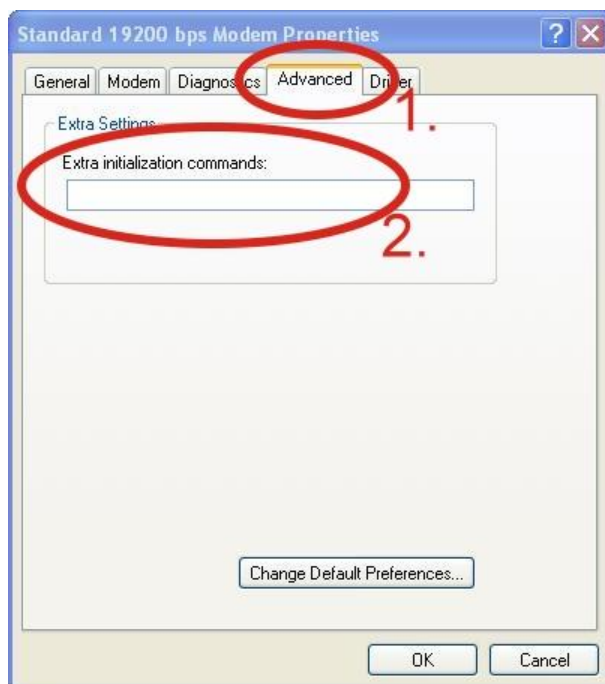

步驟 11：Diagnostics → Query Modem → 點擊“OK”

備註：如果出現錯誤訊息，請再試一次

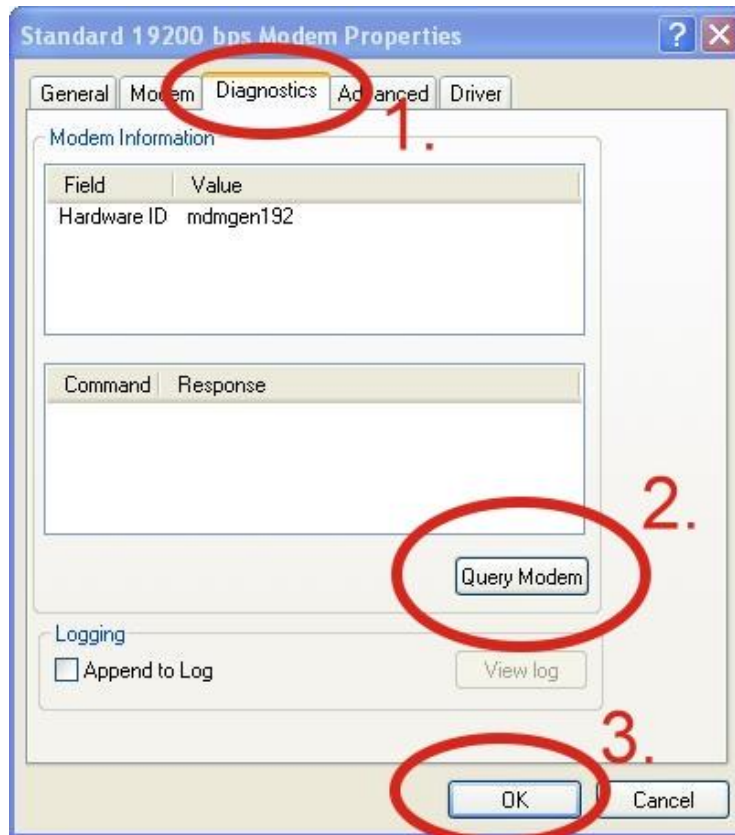

步驟 12：點擊“OK”

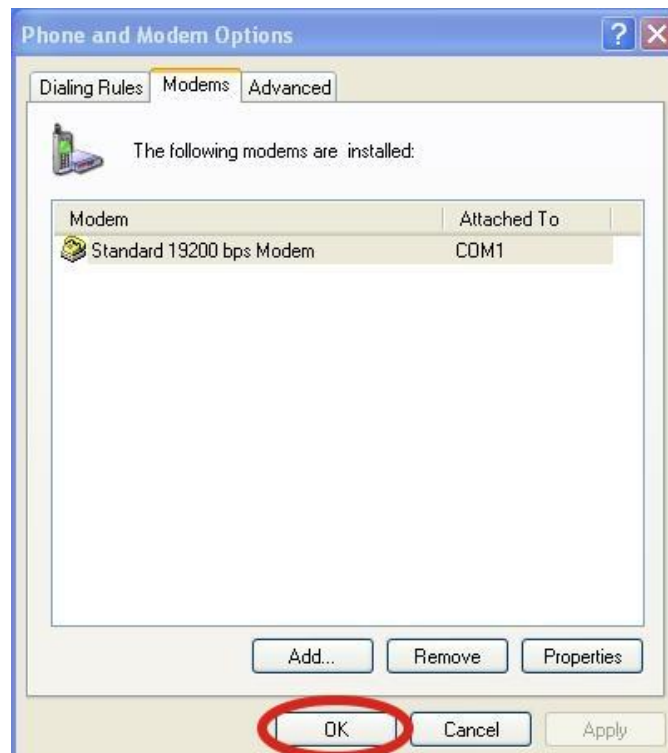



### 5.1.3 建立新網路連線

步驟 1：Control Panel → Network Connections → 點擊 “Create a new connection”

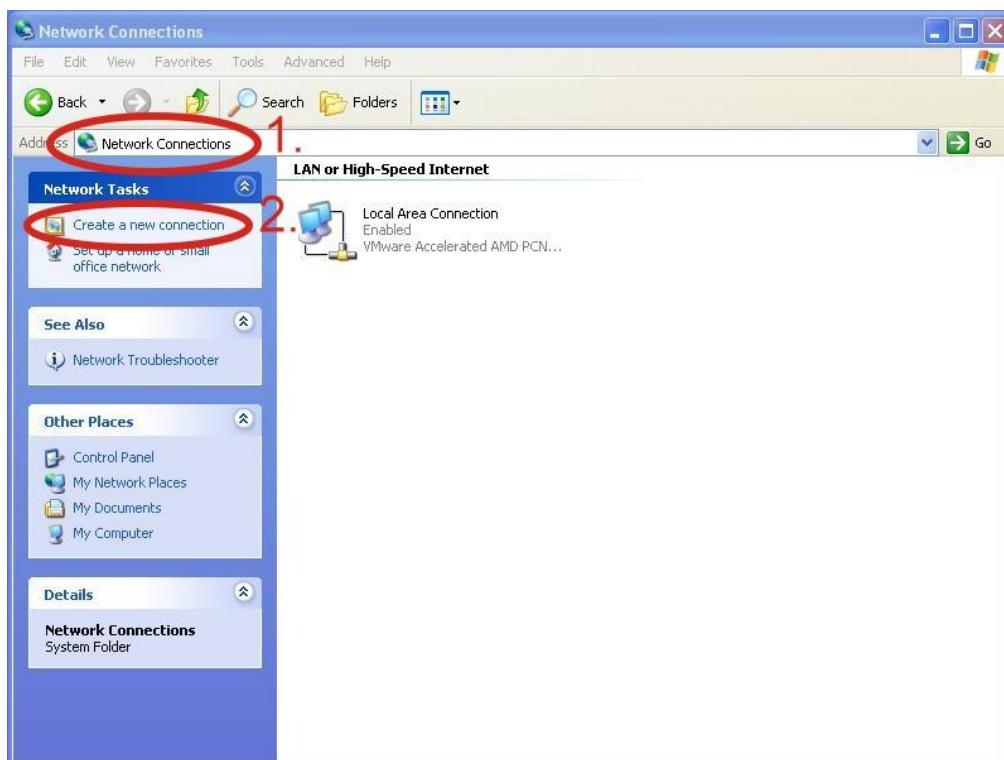

步驟 2：點擊 “Next”



步驟 3：選取 “Connect to the Internet” → 點擊 “Next”

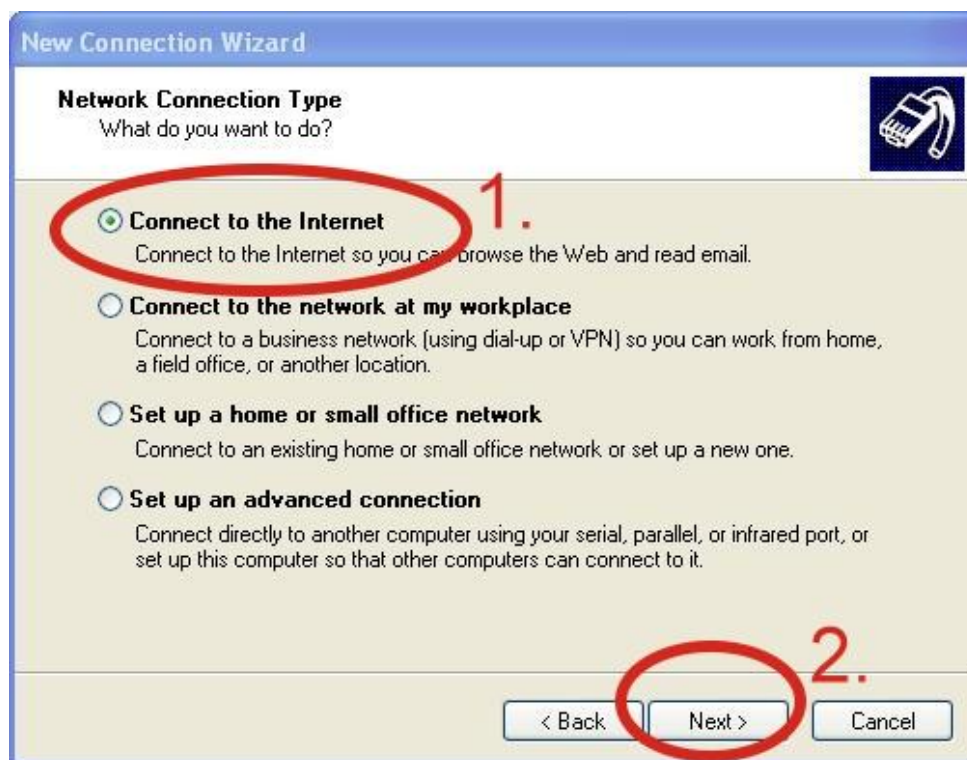

步驟 4：選取 “Connect using a dial-up modem” → 點擊 “Next”

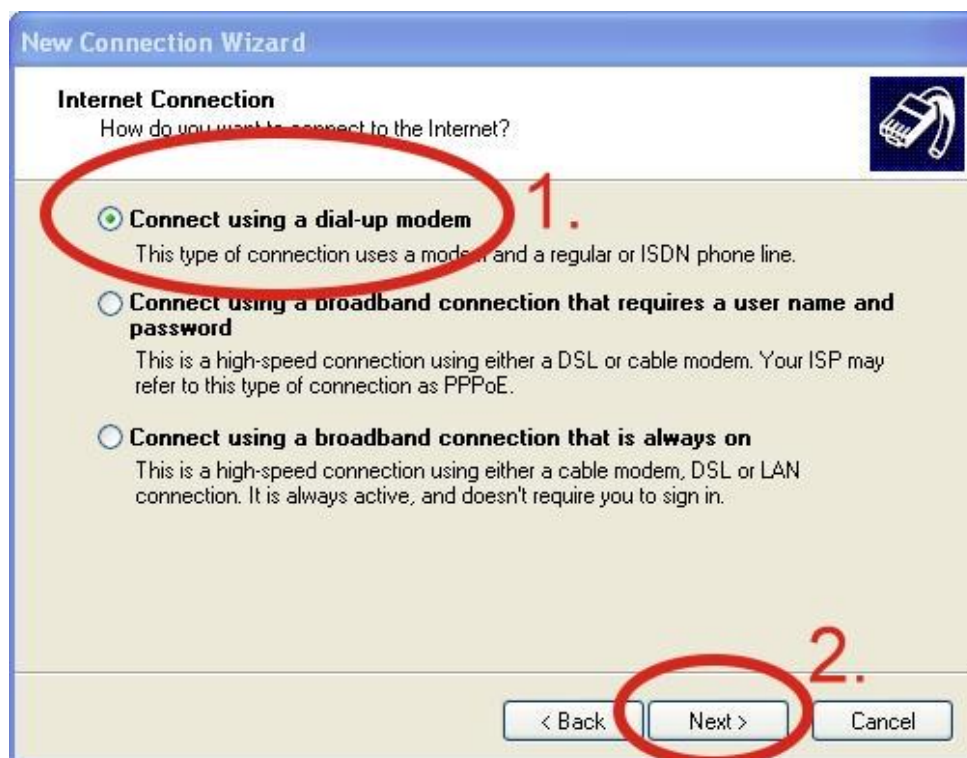

步驟 5：ISP Name → 填入您的 GPRS 名稱→ 點擊 “Next”

**New Connection Wizard**

**Connection Name**  
What is the name of the service that provides your Internet connection?

Type the name of your ISP in the following box.

ISP Name **1.**

The name you type here will be the name of the connection you are creating.

**2.**

< Back Next > Cancel

步驟 6：請輸入您的電話號碼 → 點擊 “Next”

備註：電話號碼由您當地的電信業者提供，例如台灣為\*99\*\*\*1#

**New Connection Wizard**

**Phone Number to Dial**  
What is your ISP's phone number?

Type the phone number below.

Phone number: **1.**

You might need to include a "+" or the area code, or both. If you are not sure you need the extra numbers, dial the phone number on your telephone. If you hear a modem sound, the number dialed is correct.

**2.**

< Back Next > Cancel

步驟 7：請輸入您 GPRS 的帳號及密碼 → 點擊 “Next”

備註：GPRS 的帳號密碼您當地的電信業者提供

**New Connection Wizard**

**Internet Account Information**  
You will need an account name and password to sign in to your Internet account.

Type an ISP account name and password, then write down this information and store it in a safe place. (If you have forgotten an existing account name or password, contact your ISP.)

User name:

Password:

Confirm password:

Use this account name and password when anyone connects to the Internet from this computer.

Make this the default Internet connection.

Turn on Internet Connection Firewall for this connection.

< Back **Next >** Cancel

步驟 8：點擊 “Finish” 完成新增

**New Connection Wizard**

**Completing the New Connection Wizard**

You have successfully completed the steps needed to create the following connection:

**Dial-up Connection**

- Make this the default connection
- This connection is firewalled
- Share with all users of this computer
- Use the same user name & password for everyone

The connection will be saved in the Network Connections folder.

Add a shortcut to this connection to my desktop

To create the connection and close this wizard, click Finish.

< Back **Finish** Cancel

步驟 9：Control Panel → Network Connections → 點選 “Your GPRS’ s name” → File  
→ Properties

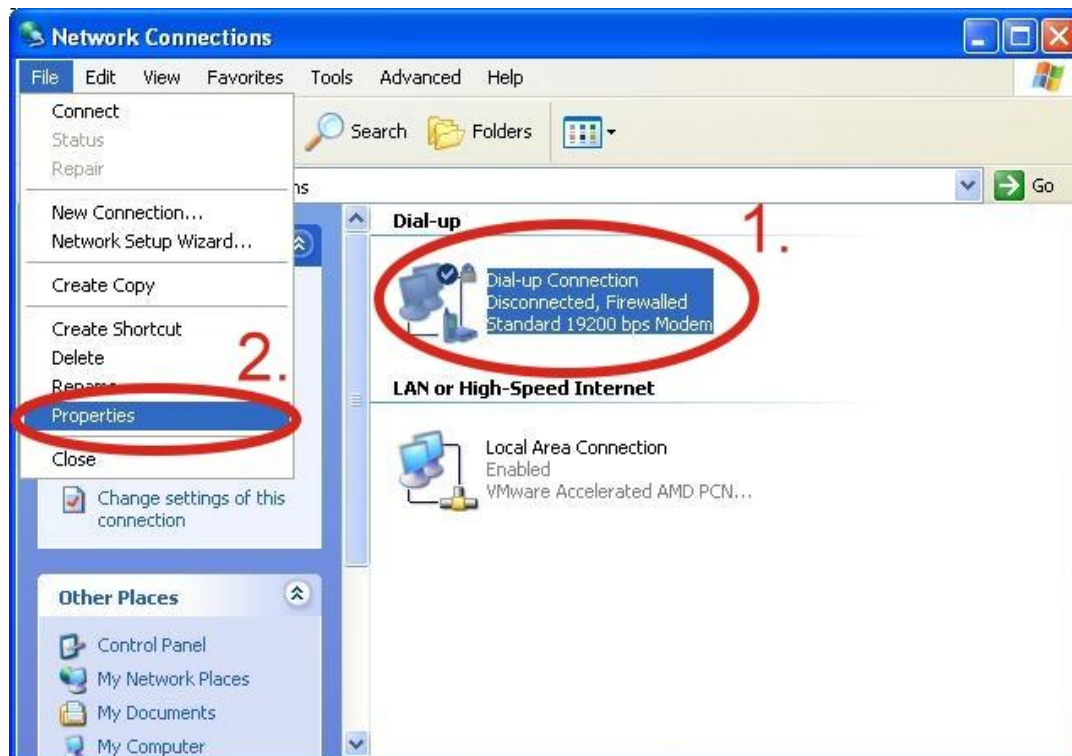

步驟 10：General → 選擇 “Standard 19200 bps Modem” → 點擊 “Configure”

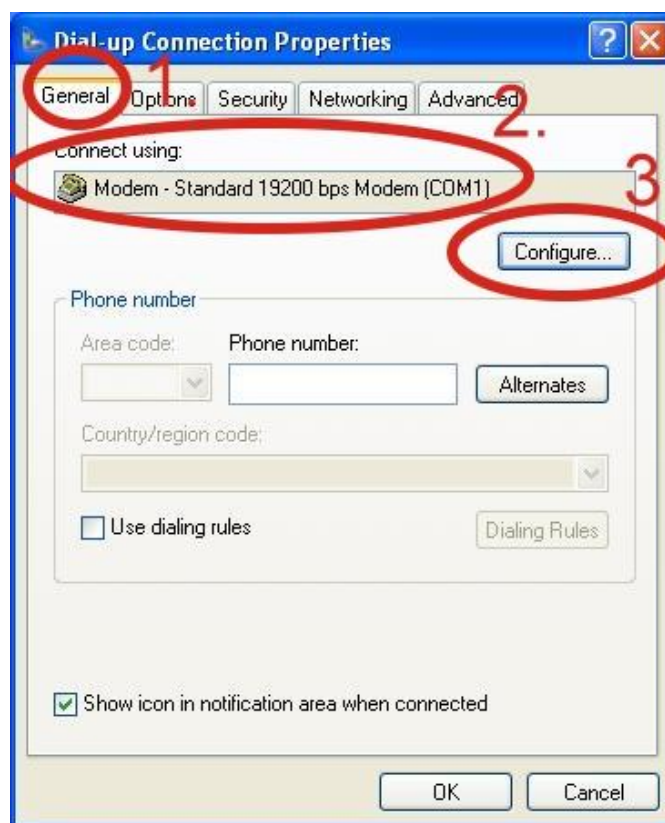

步驟 11：Maximum speed(bps)選擇“115200”，取消勾選  
“Enable hardware flow control” (備註) → 點擊“OK”

備註：請勿勾選“Enable hardware flow control”



步驟 12：點擊“OK”

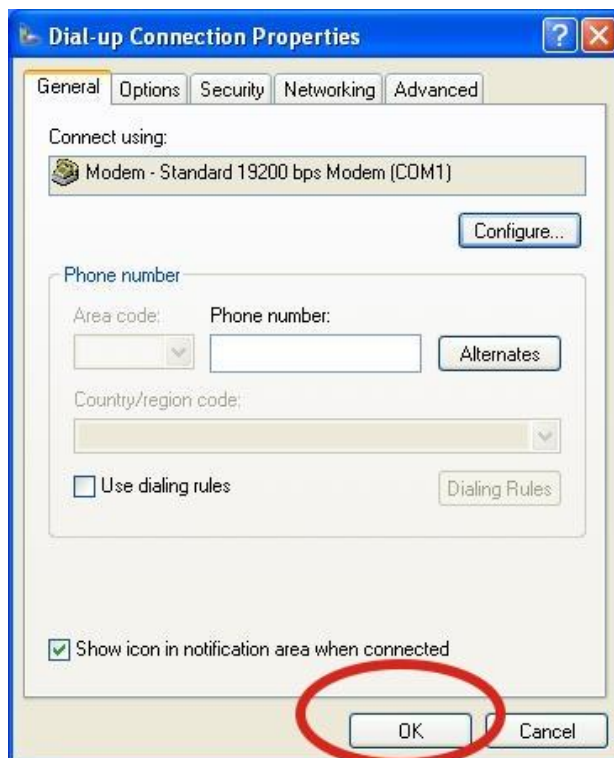

步驟 13 : Control Panel → Network Connections → 雙擊 “Your GPRS’ s name”

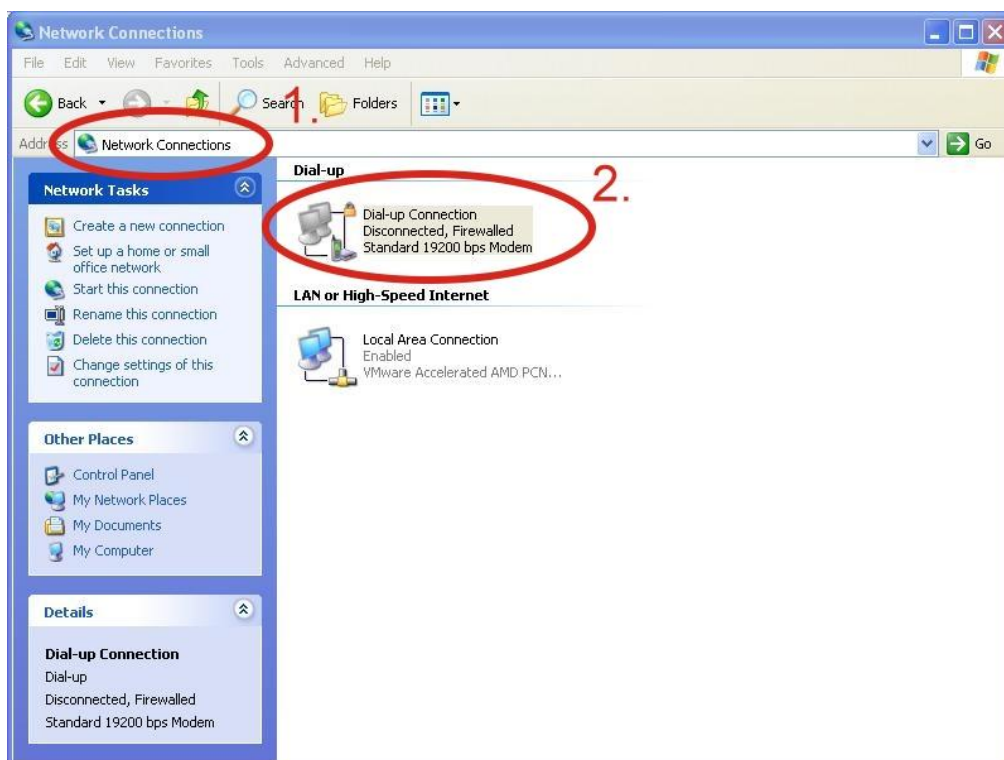

步驟 14 : 點擊 “Dial”



步驟 15：當您連線成功時，右下角工具列會顯示新的連線成功圖示



步驟 16：您可以連點兩下這個圖示 → 選擇“Details” → 取得您的 IP 位址

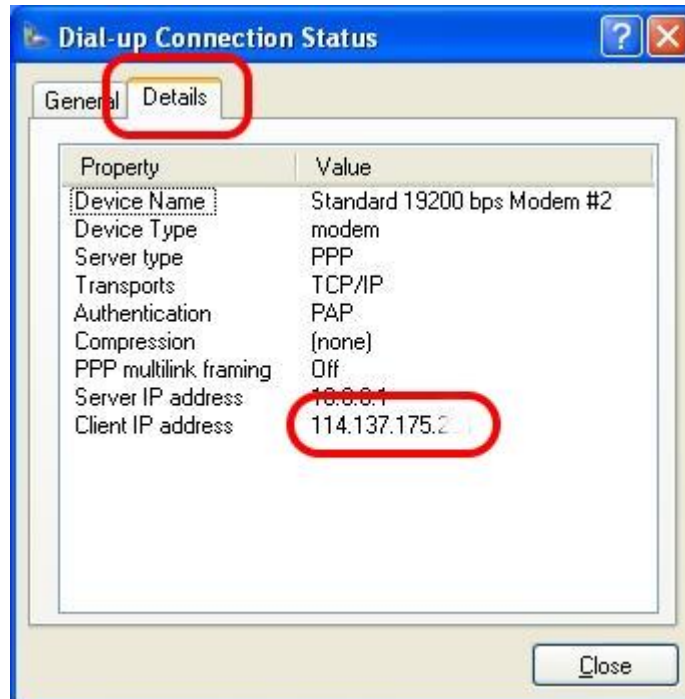



## 6. USB 驅動程式安裝

### 6.1 XPAC-8000 (Microsoft Windows XP)

步驟 1：雙擊 “GTM-204M-4G USB driver V1.00.exe” 開始安裝驅動程式

步驟 2：點擊 “Next”

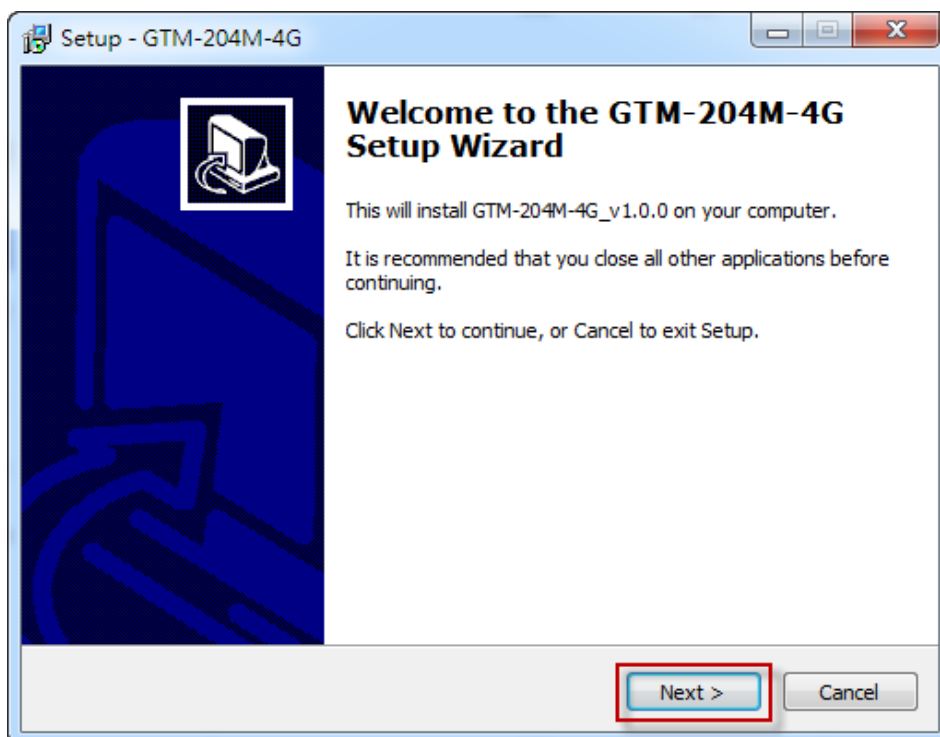

步驟 3：點擊 “Next”

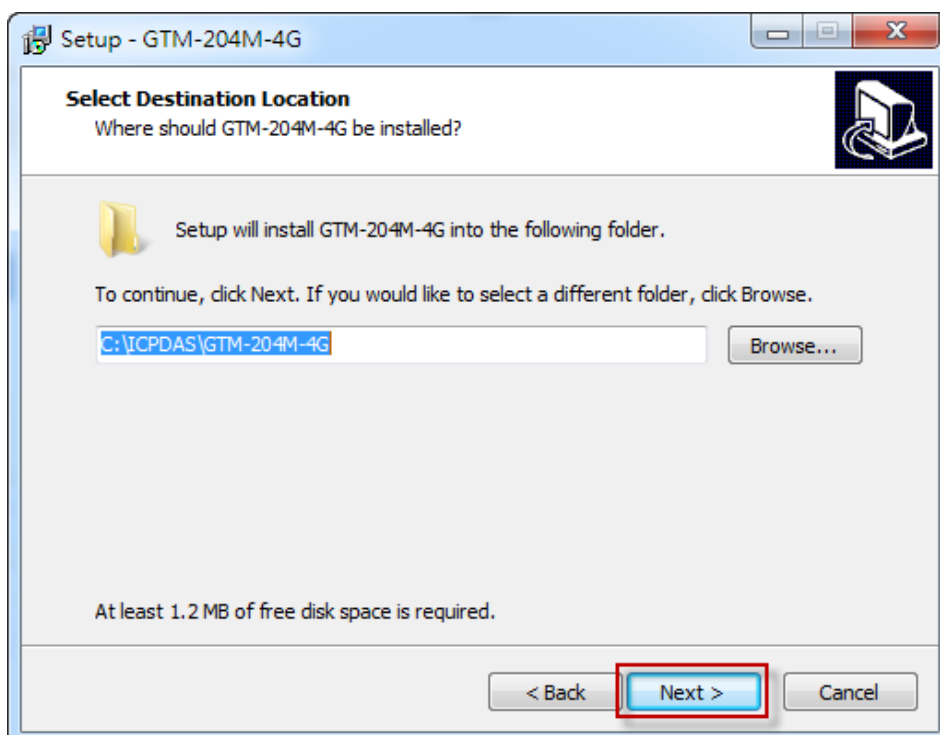

## 步驟 4：點擊 “Install”

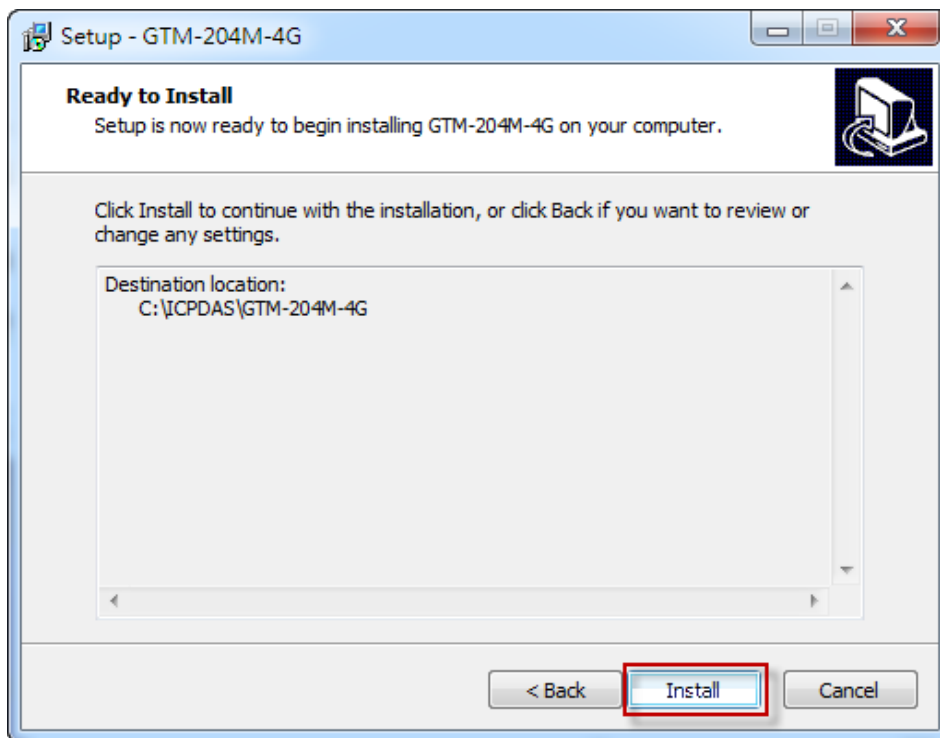

## 步驟 5：點擊 “Finish”

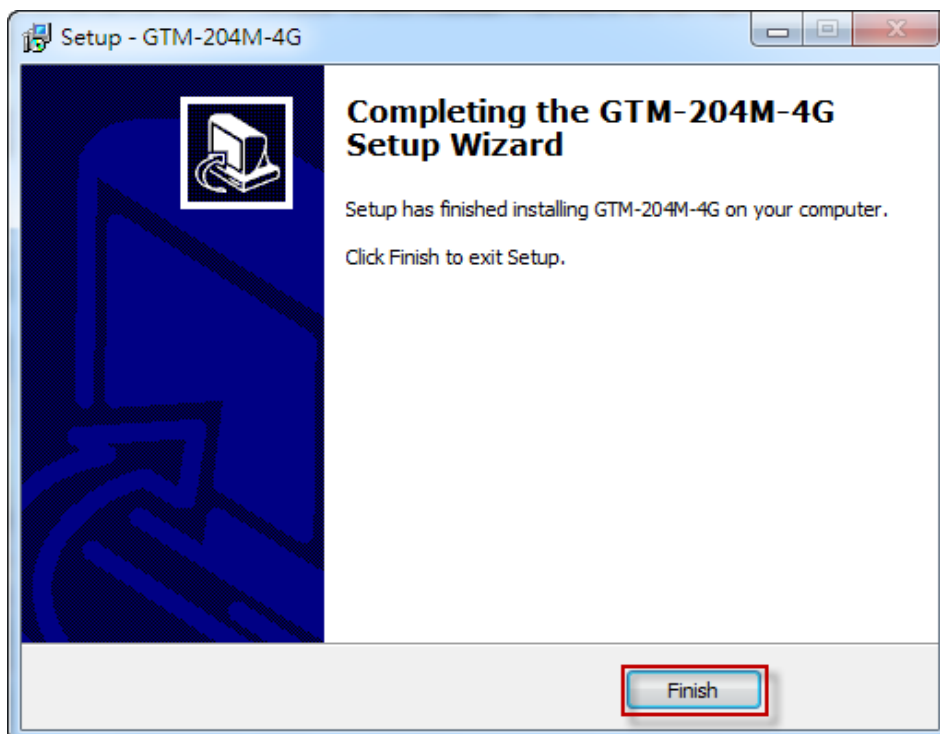

步驟 6：透過 USB 連接線連接 GTM-204M-4G 及 PC

步驟 7：彈出“Found New Hardware Wizard”視窗要您安裝“Quectel LTE Module”的驅動程式，請點擊“Next”至下一步

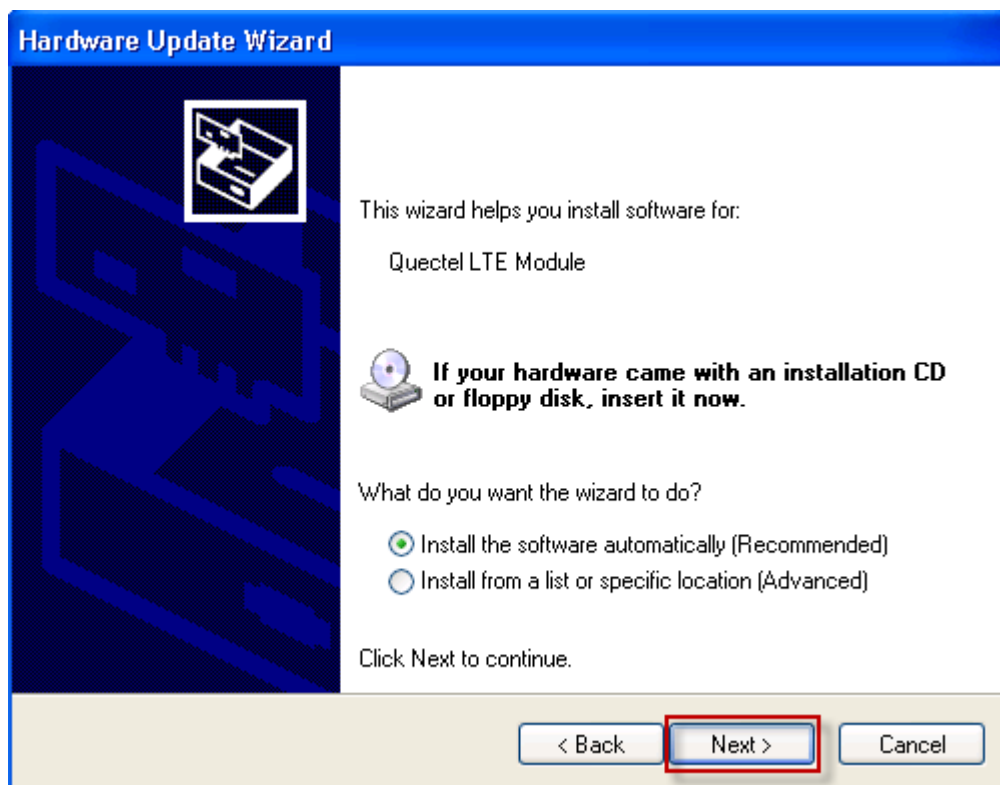

步驟 7-1：請點擊“Continue Anyway”



步驟 7-2：若您接收到安裝成功的訊息，請點擊“Finish”結束安裝

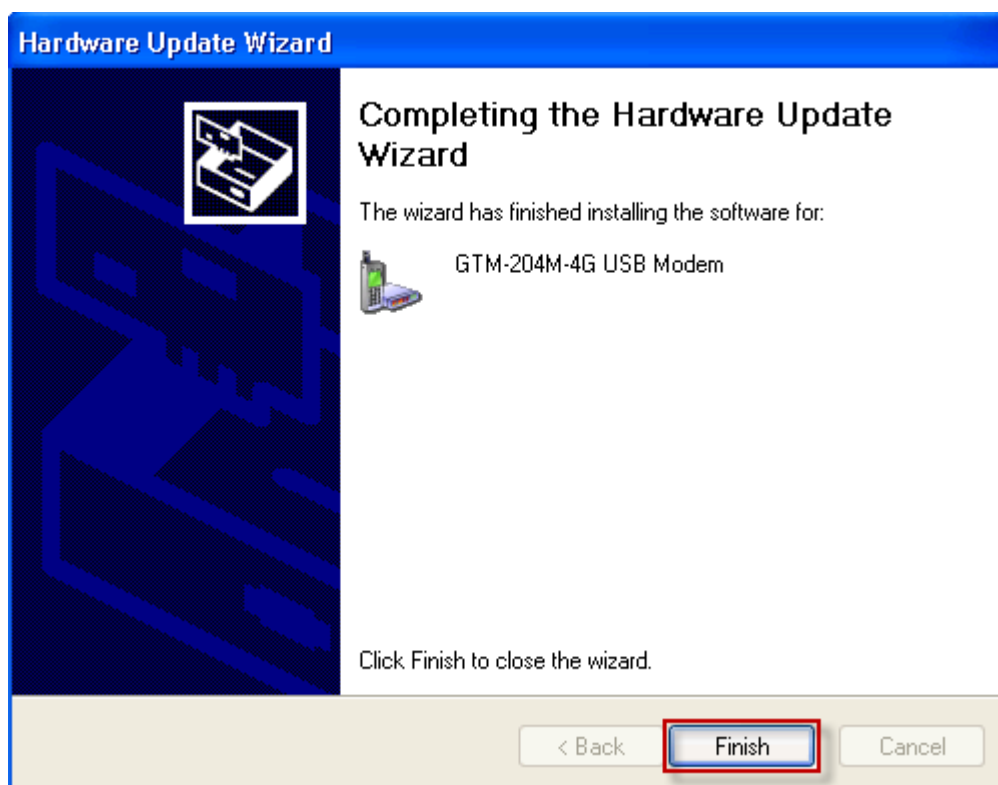

步驟 7-3：若您接收到安裝失敗的訊息，請點選 “Install from a list or specific location”，並點擊 “Next” 至下一步

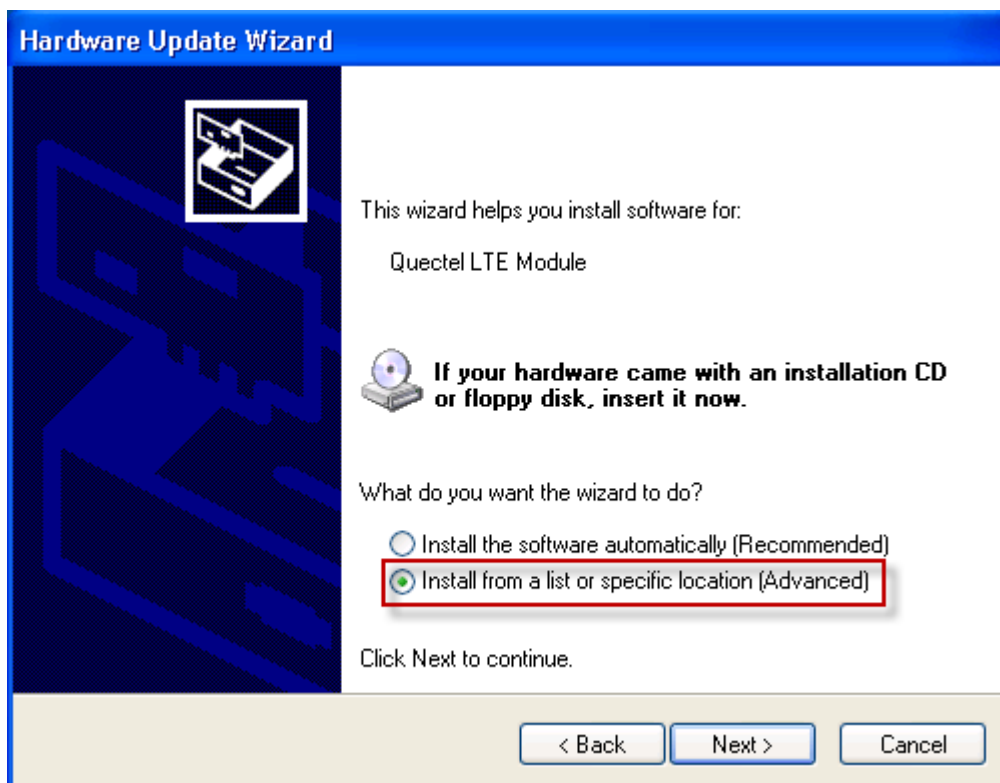

步驟 7-4：點擊 “Browse” 瀏覽與選擇您的安裝資料夾，點擊 “Next” 至下一步

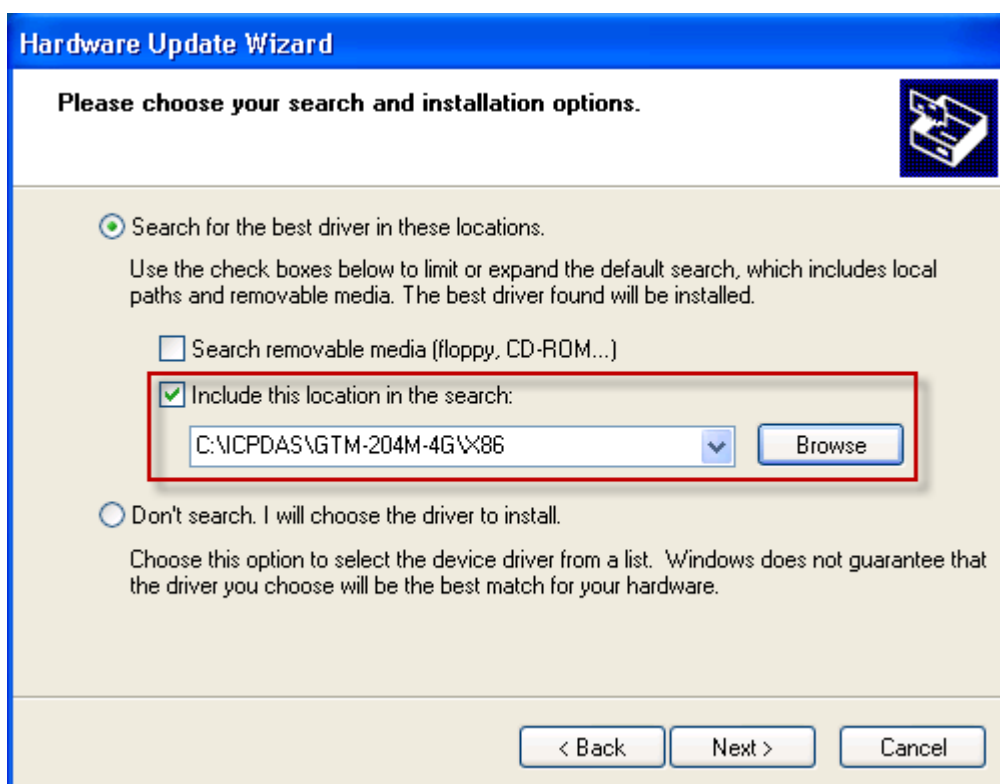

步驟 8：彈出“Hardware Installation”視窗要您安裝“GTM-204M-4G Wireless Ethernet Adapter”的驅動程式，請點擊“Continue Anyway”



步驟 9：彈出“Hardware Installation”視窗要您安裝“GTM-204M-4G USB AT Port”的驅動程式，請點擊“Continue Anyway”



步驟 10：彈出“Hardware Installation”視窗要您安裝“GTM-204M-4G USB NMEA Port”的驅動程式，請點擊“Continue Anyway”



Step 11 : The “Hardware Installation” window for “GTM-204M-4G USB DM Port” will pop-out. Please click “Continue Anyway”.



步驟 12：完成安裝步驟後，請開啟“Device Manager”，確認已新增 8 個裝置項目，如下圖所示：

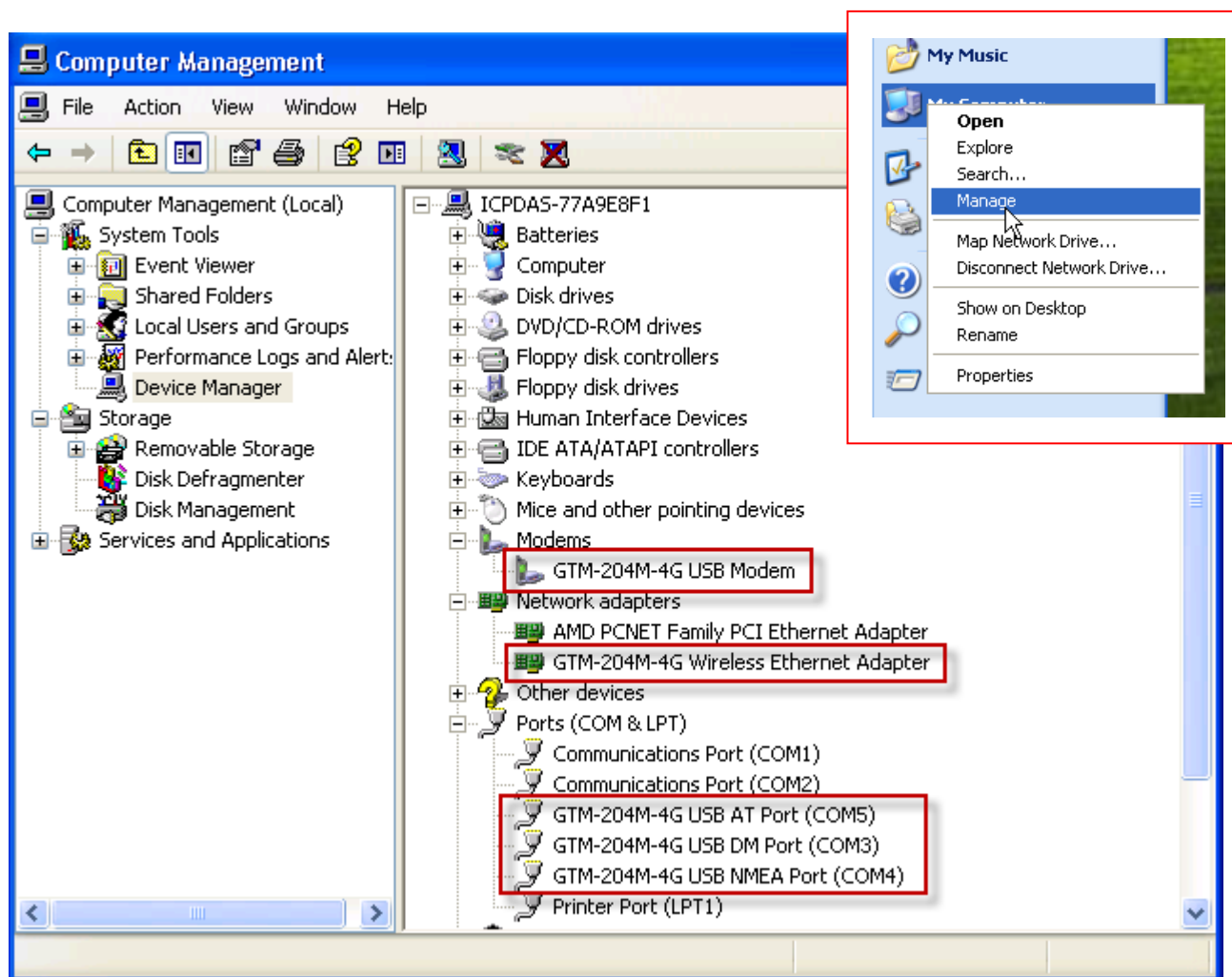



## 7. Revision History

Revision	Date	Author	Description
1.0	2016/06/14	Eddie	First Release
1.1	2016/09/09	Eddie	Modify Hardware Specifications
1.2	2017/08/15	Eddie	Update Hardware Specifications
1.3	2017/09/05	Eddie	Update Hardware Specifications