

Features

- Excellent C/P ratio (cost/performance)
- High-resolution color touch screen
- PoE (Power over Ethernet)
- RS-485 (including Self-Tuner)
- RTC (Real Time Clock)
- GUI design
- Free HMIWorks development tool
- Supports C programming language and Ladder Designer
- Supports the custom communication protocol (C language)
- Modbus TCP/RTU protocol
- ESD Protection: 4 kV
- Operating temperature: -20 ~ 70°C

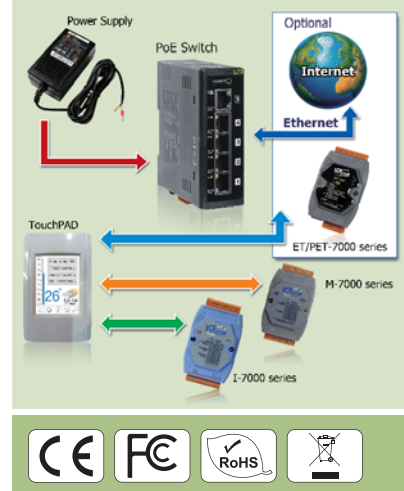

Introduction

TPD-280/TPD-280U/TPD-283/TPD-283-BK/TPD-283U, is a series of tiny touch HMI and designed for building and home automation. TPD-280/TPD-280U/TPD-283/TPD-283-BK/TPD-283U is equipped with high resolution TFT color touch screen and fits in with regular electrical wall-mount outlet. Besides, it is seamlessly integrated with rich I/O modules and presents beautiful, flexible and user-defined picture frame. In short, it is the best choice to upgrade the mechanical switch to intelligent control pads.

For PLC users, HMIWorks provides Ladder Designer, and for IT users, C language environment is provided. Especially, it only takes no more than 30 minutes to learn how to create an application program of TPD-series devices when using Ladder Designer. Moreover, we provide redundant solutions in our PoE version, TPD-283/TPD-283-BK, of TPD-series HMI devices. With all the features provided, TPD-series touch HMI Devices must be the most cost effective HMI Device ever been in the market.

Applications

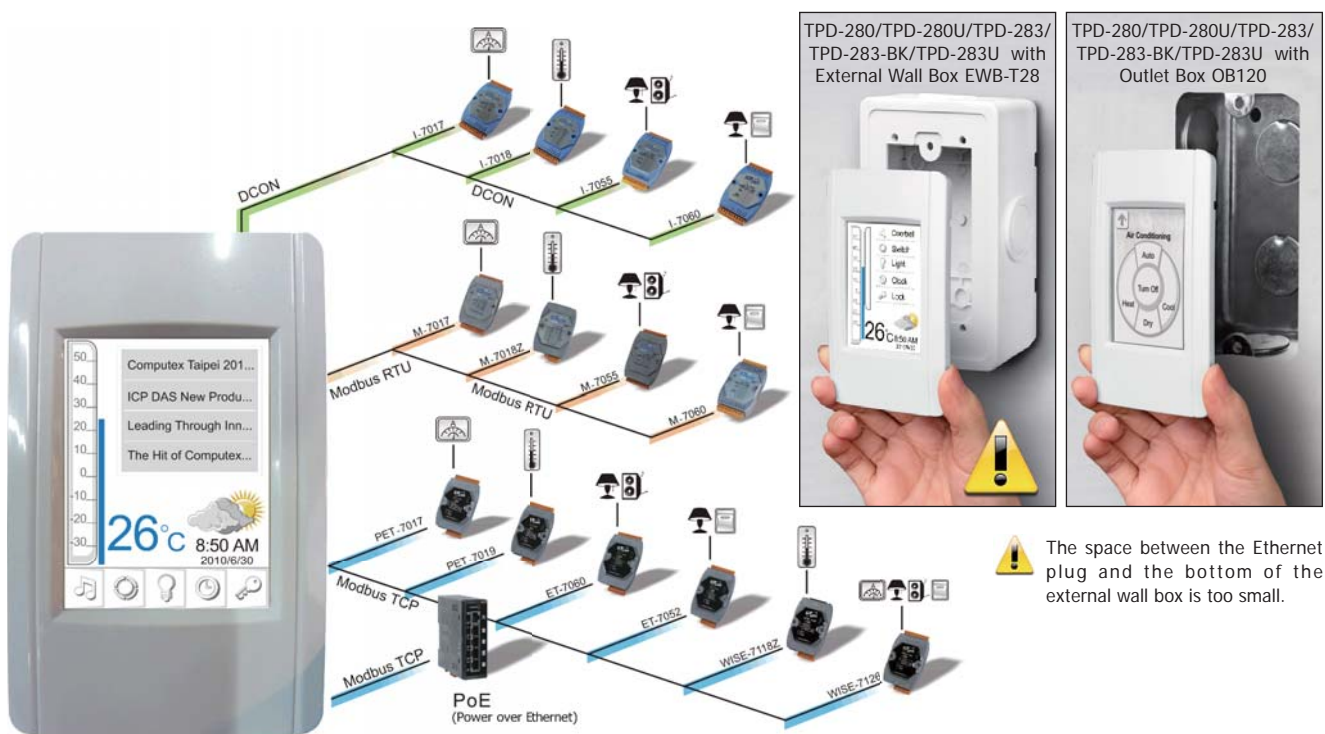

Applications

Multi-Display

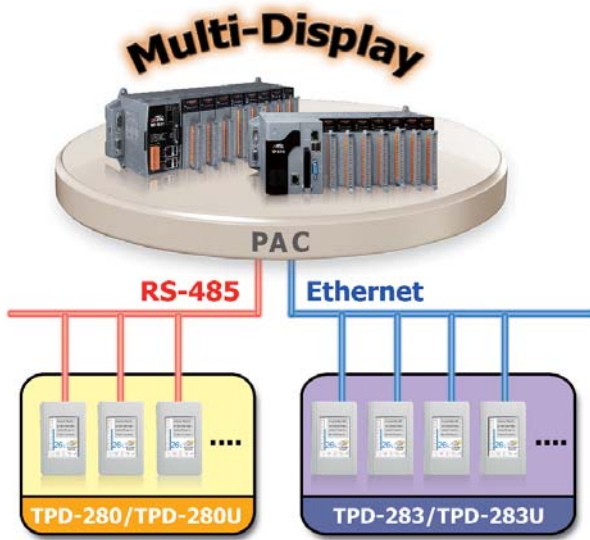

TouchPAD Anywhere

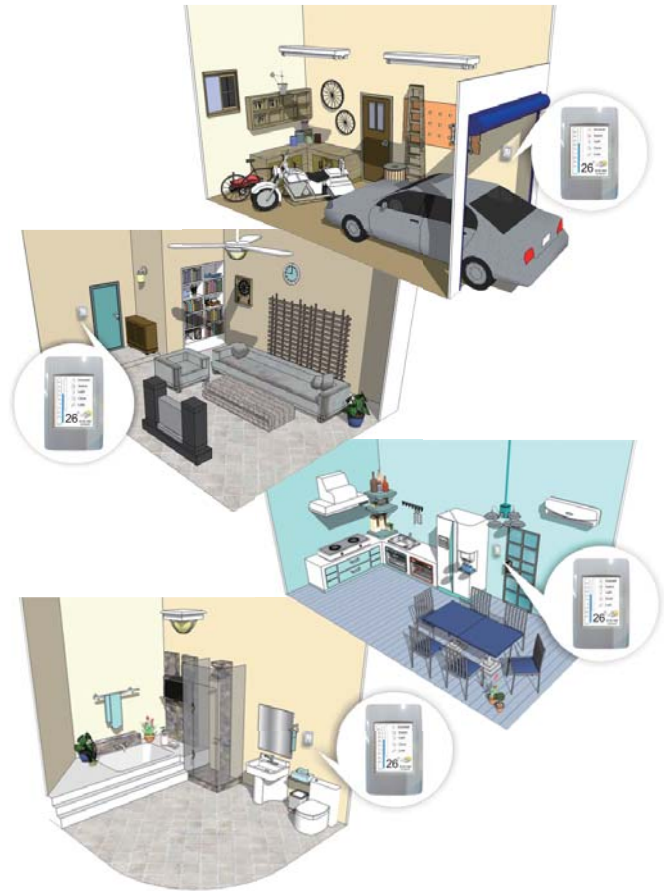

Single-way, Two-way, Multi-way Switches Example

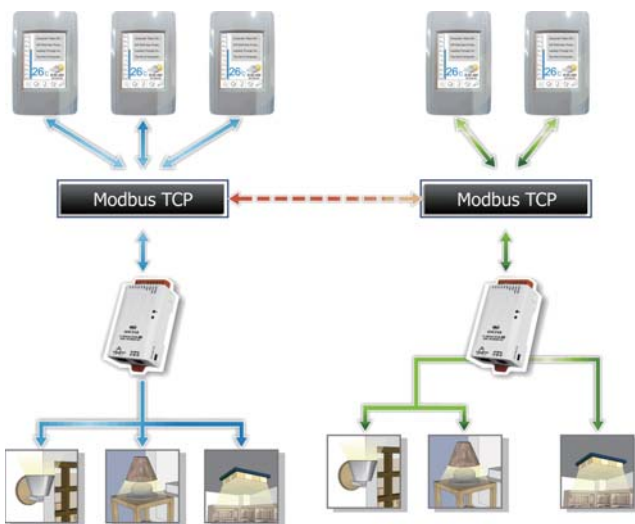

Classroom Automation Example

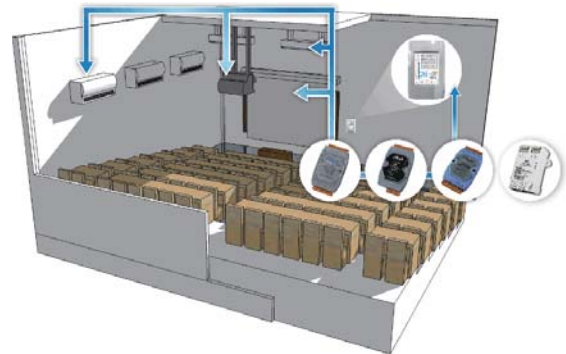

Temperature Control Example

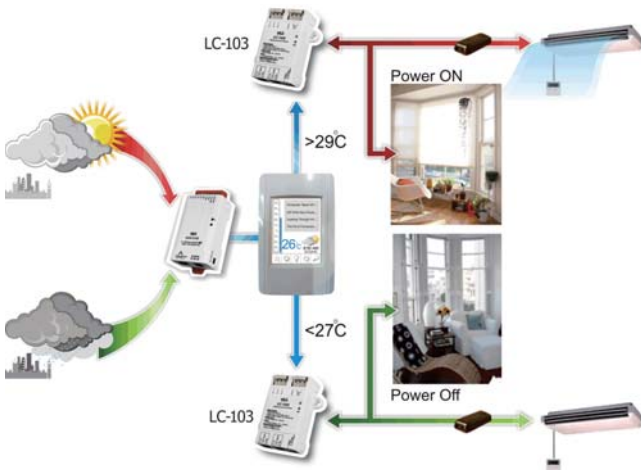

Intelligent Building Example

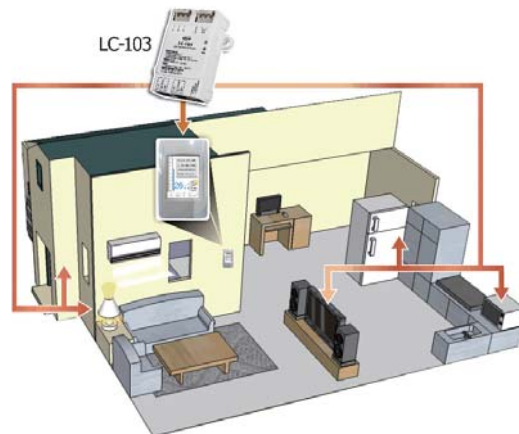

Specifications

Models	TPD-280	TPD-280U	TPD-283/TPD-283-BK	TPD-283U
CPU Module				
CPU	32-bit RISC CPU			
Memory Expansion	-	16 MB SDRAM / 8 MB Flash	-	16 MB SDRAM / 8 MB Flash
Real Time Clock (RTC)	-	Yes	-	Yes
Buzzer	Yes			
Rotary Switch (0~9)	Yes			
Communication Interface				
Ethernet	-		RJ-45 x 1, 10/100 Base-TX	
Serial Port	RS-485 (including Self-Tuner)		-	RS-485 (including Self-Tuner)
USB 1.1 Client	-	Firmware updates only	-	Firmware updates only
MMI (Main Machine Interface)				
LCD	2.8" TFT (Resolution 240 x 320 x 16), defective pixels <= 3			
Backlight Life	20,000 hours			
Brightness	160 cd/m2			
Touch Panel	Yes			
Reset Button	Yes			
Electrical				
Powered from Terminal Block	+10 ~ 30 Vdc		-	+10 ~ 30 Vdc
Powered from PoE	-		IEEE 802.3af, Class1 (48 V)	IEEE 802.3af, Class1 (48 V)
Power Consumption	1.2 W			
Mechanical				
Dimensions (W x L x H)	76 mm x 119 mm x 31 mm			
Installation	Wall Mount			
Ingress Protection	Front Panel: IP40			
Environmental				
Operating Temperature	-20 ~ +70°C			
Storage Temperature	-30 ~ +80°C			
Ambient Relative Humidity	10 ~ 90% RH, non-condensing			

Pin Assignments

TPD-280/TPD-280U/TPD-283U

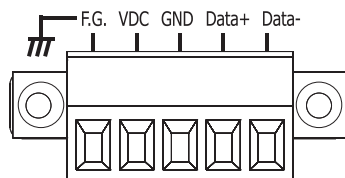

Appearance

TPD-280/TPD-280U/TPD-283/TPD-283U Front View

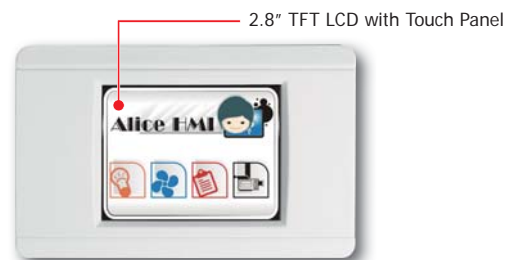

TPD-280 Rear View

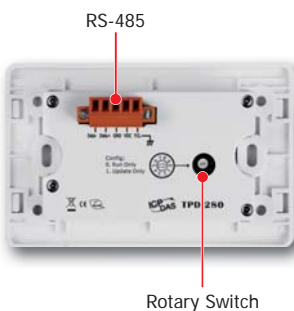

TPD-280U Rear View

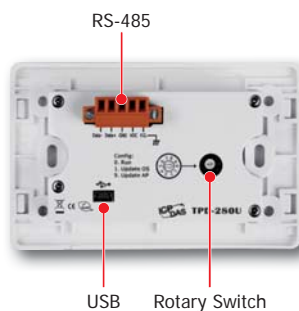

TPD-283/TPD-283-BK Rear View

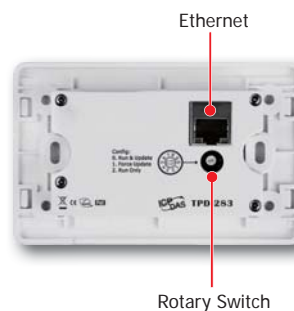

TPD-283U Rear View

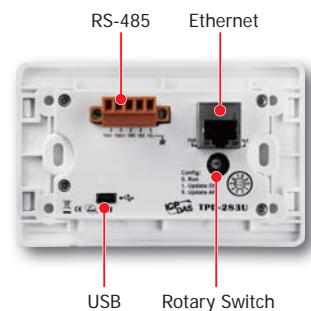

Dimensions (Units: mm)

TPD-280/TPD-280U

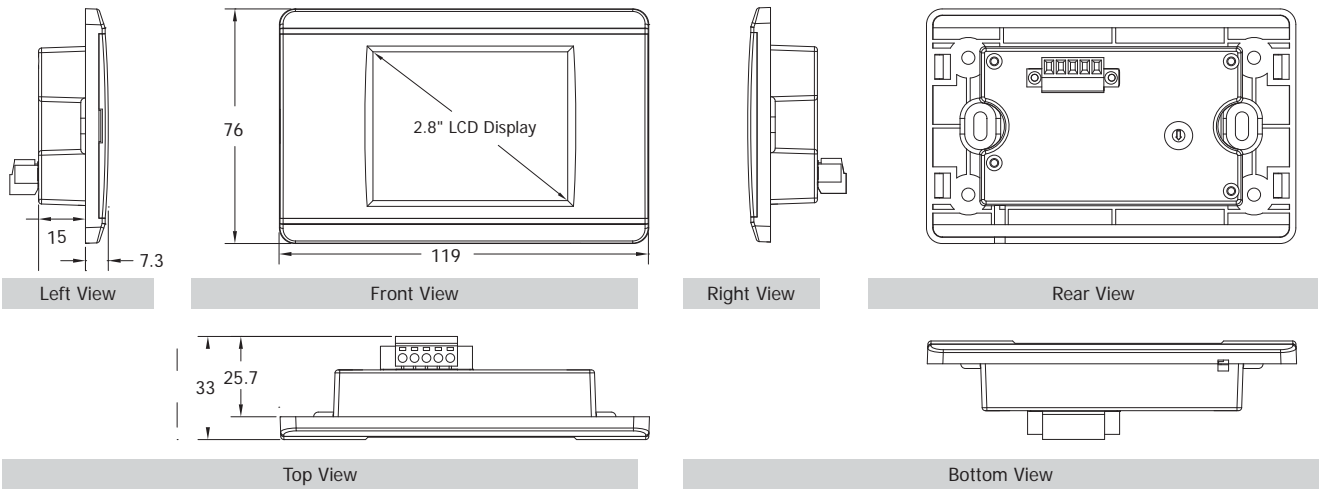



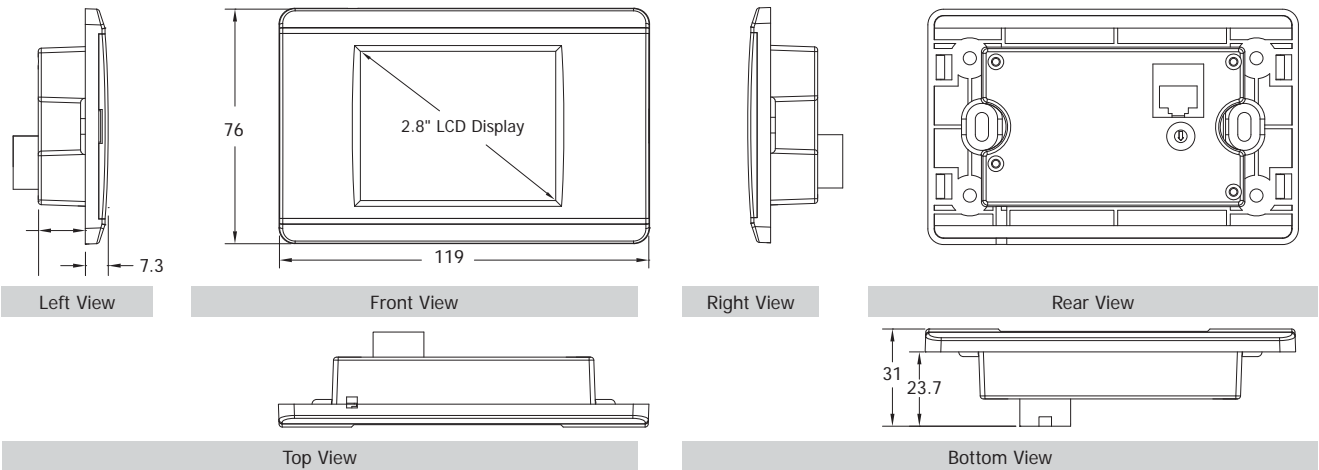

TPD-283/TPD-283-BK/TPD-283U







Ordering Information

TPD-280 CR	2.8" Touch HMI device with RS-485 (RoHS)
TPD-280U CR	2.8" Touch HMI device with RS-485, USB download, RTC (RoHS)
TPD-283 CR	2.8" Touch HMI device with Ethernet, PoE (RoHS)
TPD-283-BK CR	2.8" Touch HMI device with Ethernet, PoE (RoHS) (Black shell)
TPD-283U CR	2.8" Touch HMI device with RS-485, USB download, RTC, Ethernet, PoE (RoHS)

Accessories

 CA-USB10	USB to 5P Mini-USB, 28AWG, 1.5 m
 1C016	2.4 mm Screw driver
 NS-208PSE CR	Unmanaged Industrial PoE (Power over Ethernet) Ethernet Switch (RoHS)
 MDR-60-24 CR	24 Vdc/2.5 A, 60 W Power Supply with DIN-Rail Mounting (RoHS)

 DIN-KA52F CR	24 Vdc/1.04 A, 25 W Power Supply with DIN-Rail Mounting (RoHS)
 EWB-T28	External Wall Box for TPD-280/TPD-280U/TPD-283/TPD-283-BK/TPD-283U Devices
 OB120	Outlet Box for TPD-280/TPD-280U/TPD-283/TPD-283-BK/TPD-283U/TPD-430/TPD-433 Devices
 EWB-T28-BK	External Wall Box for TPD-283-BK Devices