

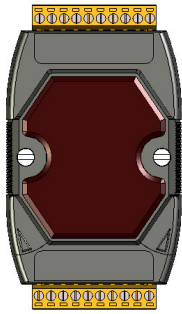

ICP DAS CO., LTD.



Quick Start For M-7064(D)



June 2016, Version 1.00

Congratulations!

Congratulations on purchasing the M-7064(D) the most popular automation solution for remote monitoring and control applications. This Quick Start Guide will provide information needed to get started with the M-7064(D). Please also consult the User Manual for detailed information on the setup and use of the M-7064(D).

What's in the shipping box?

In addition to this guide, the shipping box includes the following items:

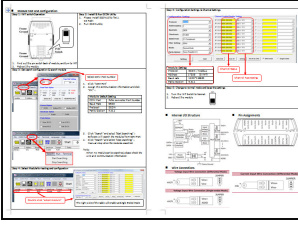
<p>M-7064(D)</p> 	<p>Plastic Rail</p> 	<p>DVD</p> 	<p>Quick Start Guide</p> 
--	---	---	--

Technical Support

- 7000 Series User Manual

<http://www.icpdas.com/download/7000/manual.htm>

- I-7000 Website

http://www.icpdas.com/root/product/solutions/remote_io/rs-485/i-7000_m-7000/m-7064.html

- ICP DAS Website

<http://www.icpdas.com>

1 Understanding the Hardware Specifications and Wiring Diagrams

Before installing the hardware, you should have a basic understanding of hardware specification and the wiring diagrams.

I/O Specifications

Model	M-7064	M-7064D
Relay Output		
Channels	Form A × 8	
Relay Type	Signal Relay	
Form A	Contact Rating	2 A @ 30 Vdc 0.24 A @ 220 Vdc 0.25 A @ 250 VAc
	Min. Contact Load	10 mA @ 20 mV
	Contact Material	Silver Nickel, Gold-covered
	Operate Time	3 ms (typical)
	Release Time	4 ms (typical)
	Mechanical Endurance	10 ⁸ ops
	Electrical Endurance	2 X 10 ⁵ ops
Surge Strength	2000 Vdc	
Power-on Value	Yes	
Safe Value	Yes	

Pin Assignment

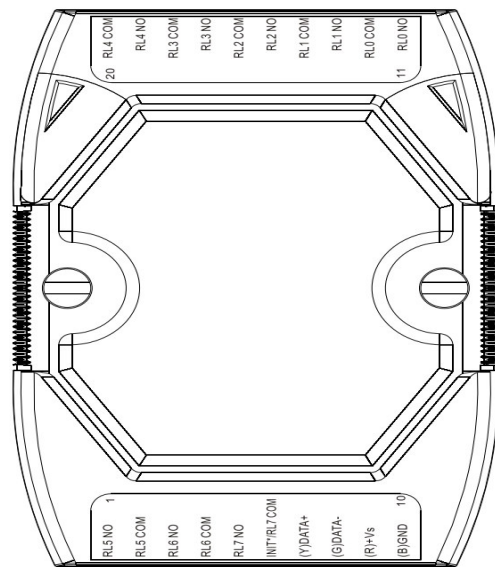

Wire Connection

Output Type	ON State Readback as 1	OFF State Readback as 0
Relay Output RL0 ~ RL6		
Relay Output RL7		



ICP DAS CO., LTD.

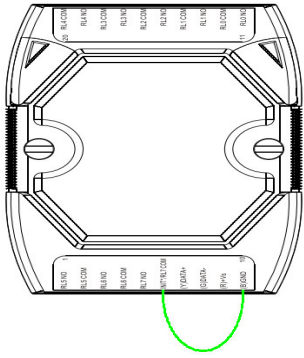

2 Booting the M-7064(D) in Init Mode

Make sure the INIT* wire to (B)GND.

3 Connecting to the PC and the Power Supply

M-7064(D) series modules are equipped with an RS-485 port that can be used to connect to an RS-232/USB converter to connect the module to a host PC

Connect to the PC using an RS-232 Converter

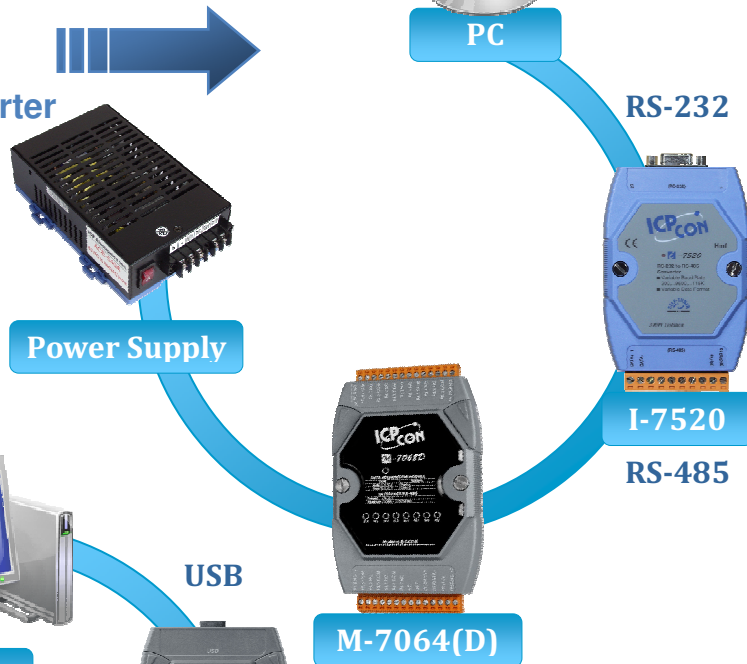

Connect to the PC using a USB Converter

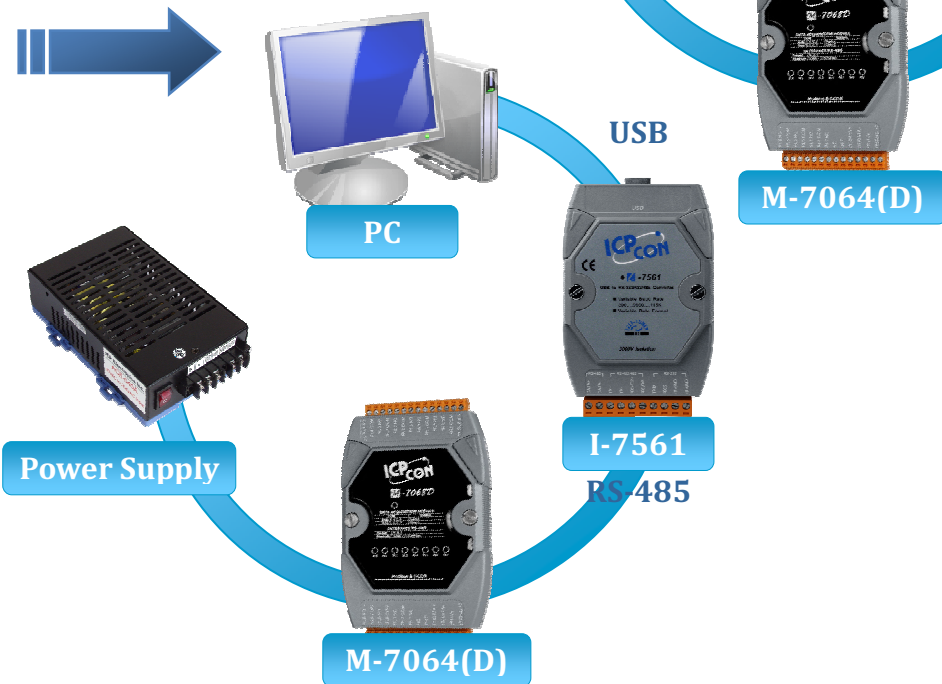

M-7064(D) Quick Start

4 Download the DCON Utility Pro

The DCON Utility Pro is an easy-to-use tool designed to enable simple configuration of I/O modules that use the DCON protocol Pro.

Step 1: Locate the DCON Utility



DCON_Utility_Pro.exe

The DCON Utility Pro can be obtained from the companion from the ICPDAS site:

<http://www.icpdas.com/download/7000/7000.htm>

5 Using the DCON Utility Pro to Initialize the M-7064(D) Module

The M-7064(D) is an I/O module based on the DCON protocol, meaning that you can use the DCON Utility Pro to easily initialize it.

Step 1: Run the DCON Utility Pro



DCON_Utility_Pro.exe

Double-click the DCON Utility shortcut on your desktop.

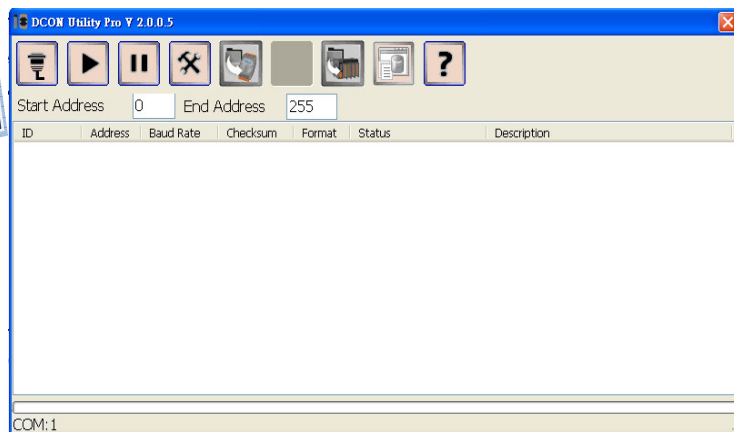

Step 2: Use the COM1 port to communicate with the M-7064(D)



ICP DAS CO., LTD.

Click the “COM Port” option from the menu and a dialog box will be displayed that will allow you to set the communication parameters as described in the table below.

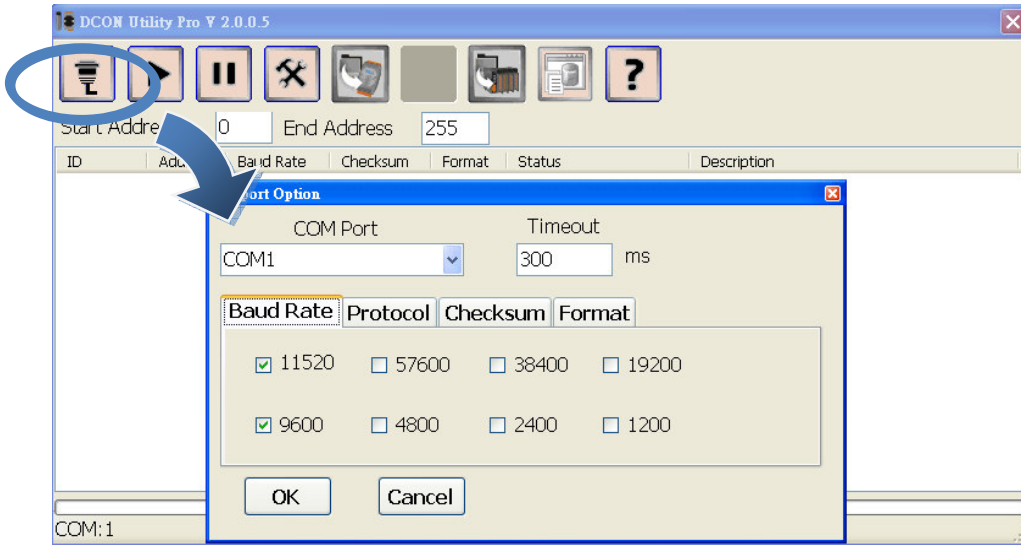

Communication parameter	Factory default Value
Address	00
Baud Rate	9600
Protocol	DCON
Checksum	Disabled
Parity	N,8,1

Step 3: Search for the M-7064(D) module

Click “Start Search” button from the toolbox to search for the M-7064(D) module. After the M-7064(D) module was display in the list, click “Stop Search” button.

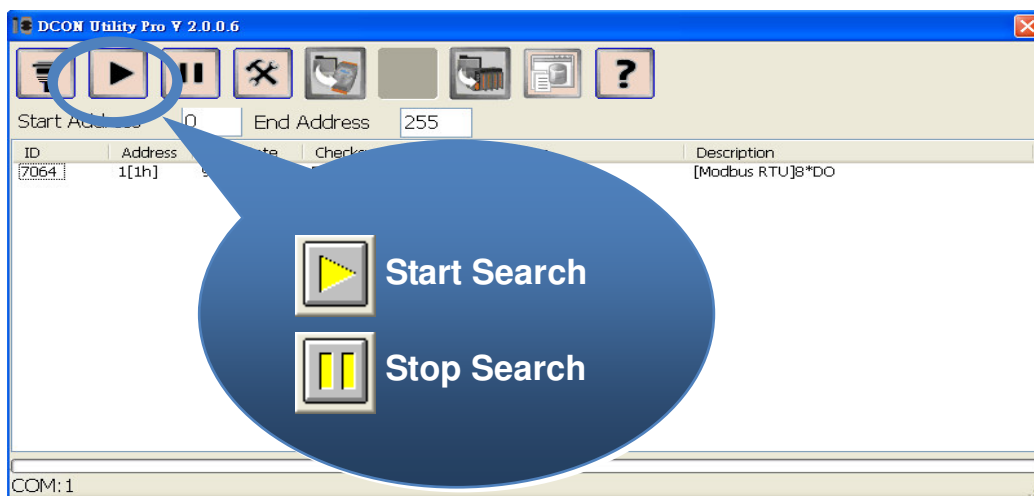

Step 4: Connect to the M-7064(D)

After clicking on the name of the module in the list, a dialog box would be display.

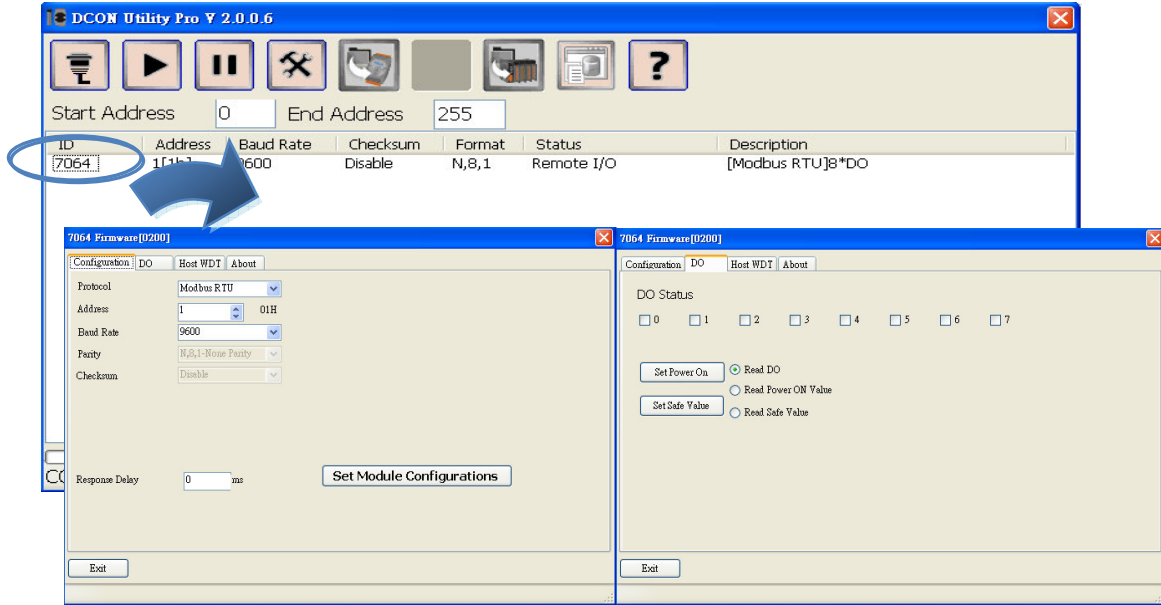

Step 5: Initialize the M-7064(D) module

Set the “Address” field in the dialog box to 1 and then click “Setting” button to save the settings.

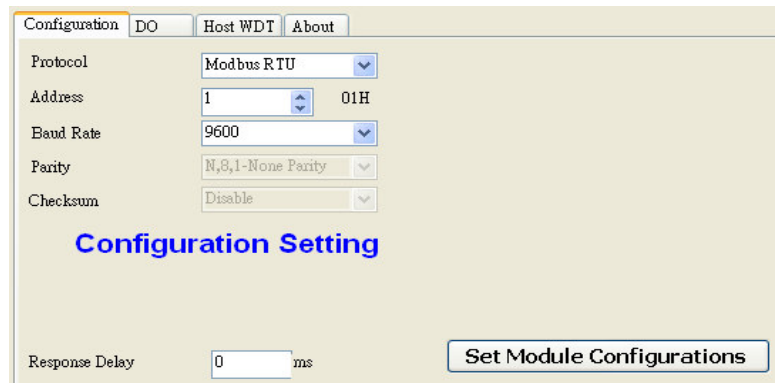
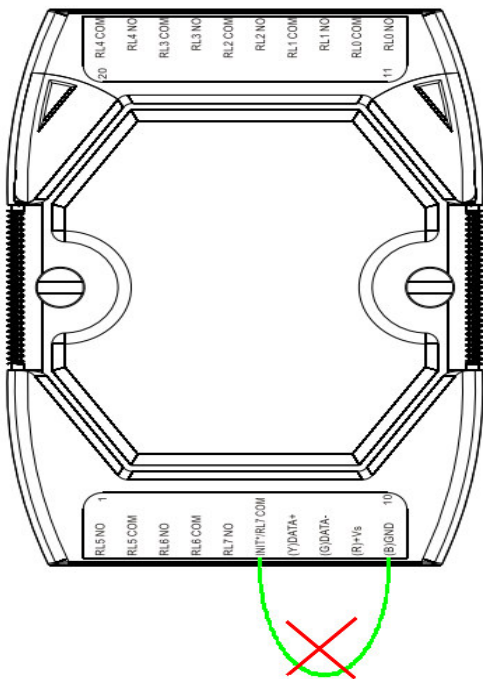

6 Rebooting the M-7064(D) Module in Normal Mode

Make sure the INIT* and (B)GND connection has been disconnected

7 Starting the Module Operation

After rebooting the M-7064(D) module, search for the module to make sure the settings have been changed. You can double click on the name of the module in the list to open the configuration dialog box.

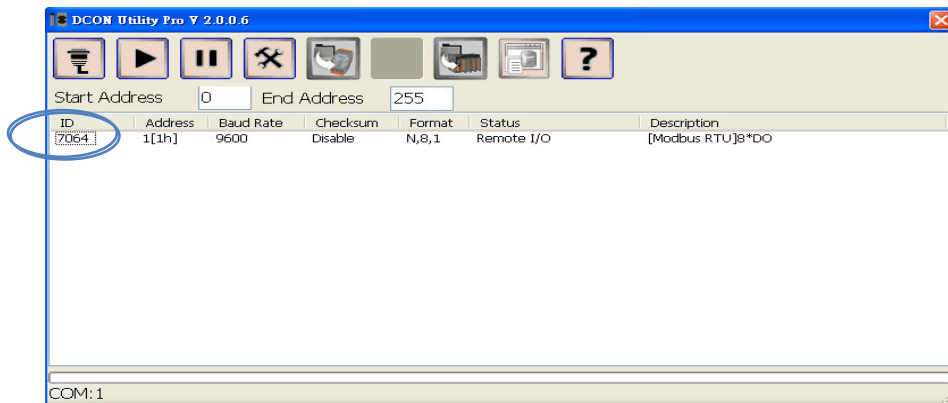

■ Modbus Table

Address	Description	R/W
00001 ~ 00004	DO Value	R/W
00033 ~ 00036	DI Value	R
10001 ~ 10004		
00065 ~ 00068	DI Latch High Value	R
00069 ~ 00072	DO Latch High Value	R
00097 ~ 00100	DI Latch Low Value	R
00101 ~ 00104	DO Latch Low Value	R
00264	Write 1 to clear latch values (FC 05)	W
00513 ~ 00516	Write 1 to clear DI counter (FC 05, FC15)	W
30001 ~ 30004	DI Counter Value	R
40001 ~ 40004		

■ DCON Pro Protocol

Function	Command	Response	Notes
Reads the name of the module	\$AAM	!AA(Data)	AA: module address
Reads the firmware version of the module	\$AAF	!AA(Data)	
Reads the status of the digital output channels	@AA	(Data)	
Sets the digital output channels	@AA(Data)		0~F
Reads the digital input counter of channel N	#AAN	!AA(Data)	N: The channel to be read
Clears the digital input counter of channel N	\$AACN	!AA	
Reads the status of the latched DO channels	\$AALS	!(Data)	S: 0 is low, 1 is high
Clears the status of the latched DO channels	\$AAC	!AA	

For more details regarding the DCON protocol, please check the enclosed CD at:
 CD path: <\\napdos\7000\manual>
 Or from our web site at: <ftp://ftp.icpdas.com/pub/cd/8000cd/napdos/7000/manual/>