

XPacSDK/XPacSDK_CE Standard API Manual

Version 2.0.7, February 2012

Service and usage information for



XP-8041/XP-8041-CE



XP-8341/XP-8341-CE



XP-8741/XP-8741-CE

Written by Sean

Edited by Anna Huang

Warranty

All products manufactured by ICP DAS are under warranty regarding defective materials for a period of one year, beginning from the date of delivery to the original purchaser.

Warning

ICP DAS assumes no liability for any damage resulting from the use of this product. ICP DAS reserves the right to change this manual at any time without notice. The information furnished by ICP DAS is believed to be accurate and reliable. However, no responsibility is assumed by ICP DAS for its use, not for any infringements of patents or other rights of third parties resulting from its use.

Copyright

Copyright © 2012 by ICP DAS Co., Ltd. All rights are reserved.

Trademark

The names used for identification only may be registered trademarks of their respective companies.

Contact US

If you have any problem, please feel free to contact us.
You can count on us for quick response.

Email: service@icpdas.com

Contents

Preface	8
XPacSDK for XPAC with Windows Embedded Standard and Windows CE	9
XPacSDK Overview	12
XPacSDK Plug-in for Development Tools for XP-8000 Series	14
XPacSDK Plug-in for Development Tools for XPAC_CE Series.....	21
1. System Information API	30
1.1. pac_GetModuleName	32
1.2. pac_GetRotaryID	34
1.3. pac_GetSerialNumber.....	35
1.4. pac_GetSDKVersion	37
1.5. pac_ChangeSlot	39
1.6. pac_CheckSDKVersion.....	41
1.7. pac_ModuleExists	43
1.8. pac_GetOSVersion (for XPAC_CE series only)	45
1.9. pac_GetMacAddress (for XPAC_CE series only).....	46
1.10. pac_ReBoot (for XPAC_CE series only)	47
1.11. Pac_GetCPUVersion.....	48
1.12. Pac_EnableLED (for XPAC_Atom series only)	49
2. Backplane Access API	51
2.1. pac_GetDIPSwitch.....	53
2.2. pac_GetSlotCount.....	54
2.3. pac_EnableRetrigger	55
2.4. pac_GetBackplaneID	56

2.5. pac_GetBatteryLevel.....	57
3. Interrupt API	59
3.1. pac_RegisterSlotInterrupt	63
3.2. pac_UnregisterSlotInterrupt	65
3.3. pac_EnableSlotInterrupt.....	67
3.4. pac_SetSlotInterruptPriority	69
3.5. pac_InterruptInitialize	70
3.6. pac_GetSlotInterruptEvent.....	71
3.7. pac_SetSlotInterruptEvent	72
3.8. pac_SetTriggerType.....	73
3.9. pac_GetSlotInterruptID	74
3.10. pac_InterruptDone	75
4. Memory Access API.....	77
4.1. pac_GetMemorySize.....	78
4.2. pac_ReadMemory.....	80
4.3. pac_WriteMemory	82
4.4. pac_EnableEEPROM.....	84
5. Watchdog API.....	86
5.1. pac_EnableWatchDog	88
5.2. pac_DisableWatchDog.....	90
5.3. pac_RefreshWatchDog	91
5.4. pac_GetWatchDogState.....	92
5.5. pac_GetWatchDogTime	94
5.6. pac_SetWatchDogTime	96
6. Uart API.....	98

6.1. uart_Open	102
6.2. uart_Close.....	105
6.3. uart_Send	107
6.4. uart_Recv.....	109
6.5. uart_SendCmd.....	111
6.6. uart_SetTimeOut.....	113
6.7. uart_EnableCheckSum	116
6.8. uart_SetTerminator.....	118
6.9. Uart_BinSend.....	120
6.10. Uart_BinRecv	122
6.11. Uart_BinSendCmd	124
6.12. Uart_GetLineStatus.....	127
6.13. Uart_GetDataSize	129
7. PAC_IO API.....	131
7.1. pac_GetBit	136
7.2. pac_WriteDO.....	138
7.3. pac_WriteDOBit	141
7.4. pac_ReadDO	145
7.5. pac_ReadDI	148
7.6. pac_ReadDIO	151
7.7. pac_ReadDILatch	155
7.8. pac_ClearDILatch	159
7.9. pac_ReadDIOLatch.....	161
7.10. pac_ClearDIOLatch.....	165
7.11. pac_ReadDICNT	167

7.12. pac_ClearDICNT	171
7.13. pac_WriteAO	174
7.14. pac_ReadAO	177
7.15. pac_ReadAI	180
7.16. pac_ReadAIHex	183
7.17. pac_ReadAIAll	186
7.18. pac_ReadAIAllHex	188
7.19. pac_ReadCNT	190
7.20. pac_ClearCNT	193
7.21. pac_ReadCNTOverflow	195
8. Backplane timer API	198
8.1. pac_GetBPTimerTimeTick_ms	200
8.2. pac_GetBPTimerTimeTick_us	201
8.3. pac_SetBPTimer	202
8.4. pac_SetBPTimerOut	204
8.5. pac_SetBPTimerInterruptPriority	206
8.6. pac_KillBPTimer	208
9. Error Handling API	209
9.1. pac_GetLastError	210
9.2. pac_SetLastError	212
9.3. pac_GetErrorMessage	214
9.4. pac_ClearLastError	219
Appendix A. MISC API	220
A1. AnsiString (for XP-8000 series only)	221
A2. WideString (for XP-8000 series only)	223

A3. pac_AnsiToWideString (for XPAC_CE series only).....	225
A4. pac_WideToAnsiString (for XPAC_CE series only).....	226
A5. pac_DoEvents	227
Appendix B. System Error Codes	229
Appendix C. API Comparison.....	230

Preface

This manual is targeted to application developers who are developing XPAC applications with the SDK of XPAC series controller.

XPacSDK for XPAC with Windows Embedded Standard and Windows CE

This reference supports SDK of XPAC serial controller, which has two kinds of OS. One is Windows Embedded Standard and the other is Windows Compact Edition.

※ Warning: All C# sample codes for XP-8000 series only.

XPacSDK for XP-8000 series with Windows Embedded Standard (WES)

The OS of XP-8000 series is Windows Embedded Standard. It's a XP like OS.

Support more programming language: C/C++/MFC, C#, VB, VB.NET, Delphi, and BCB.

Supported programming languages include:

- For C/C++/MFC: XPacSDK.h/XPacSDK.lib/XPacSDK.dll
- For C#/VB.NET: XPacNET.dll
- For VB: XPacSDK.bas
- For Delphi: XPacSDK.pas
- For BCB: XPacSDK_BCB.lib

Each program no matter builds by which language, its execution needs XPacSDK.dll to excute.

The XPacSDK is applied for XP-8000 and XP-8000-Atom must be version 2.0.2.0 and later (The version earlier than V2.0.2.0 is only applied for XP-8000).

V: Work, X: Don't Work

API	XP-8000	PC Windows
System Information	V	X
Backplane Access	V	X
Interrupt	V	X
Memory Access	V	X
Uart	V	V
PAC_IO	V	V

Note 1: For the PC windows solution, the Microsoft .NET Framework 2.0 (or above) must be installed on PC.

Note 2: The PAC_IO API can be used to connect the I-7000 module and other modules using the DCON protocol.

XPacSDK_CE for XP-8000-CE series with Windows Compact Edition (WinCE)

The OS of XPAC_CE series is Windows Compact Edition. Different from WES OS of XP-8000 series, XPAC_CE only support Visual Studio 2005/2008, and the name of SDK is difference, either.

Supported programming languages include:

- For C/C++/MFC: XPacSDK_CE.h/XPacSDK_CE.lib/XPacSDK_CE.dll
- XPacSDK_CE.msi: This is used to install in a desktop, and then the Visual Studio can build programs which can run on the Windows CE.

The version of XPACSDK_CE library applied for both of XP-8000-CE6 and XP-8000-Atom-CE6 must be V2.0.0.5 and later (The version earlier than V2.0.0.5 is only applied for XP-8000-CE6).

The available API functions used for XP-8000-CE6 and XP-8000-Atom-CE6

V: Work, X: Don't Work

API Functions	XP-8000-CE6	XP-8000-Atom_CE6
Pac_EnableLED	X	V
Others	V	V

XPacSDK Overview

This API reference section contains descriptions of system operation and IO programming elements.

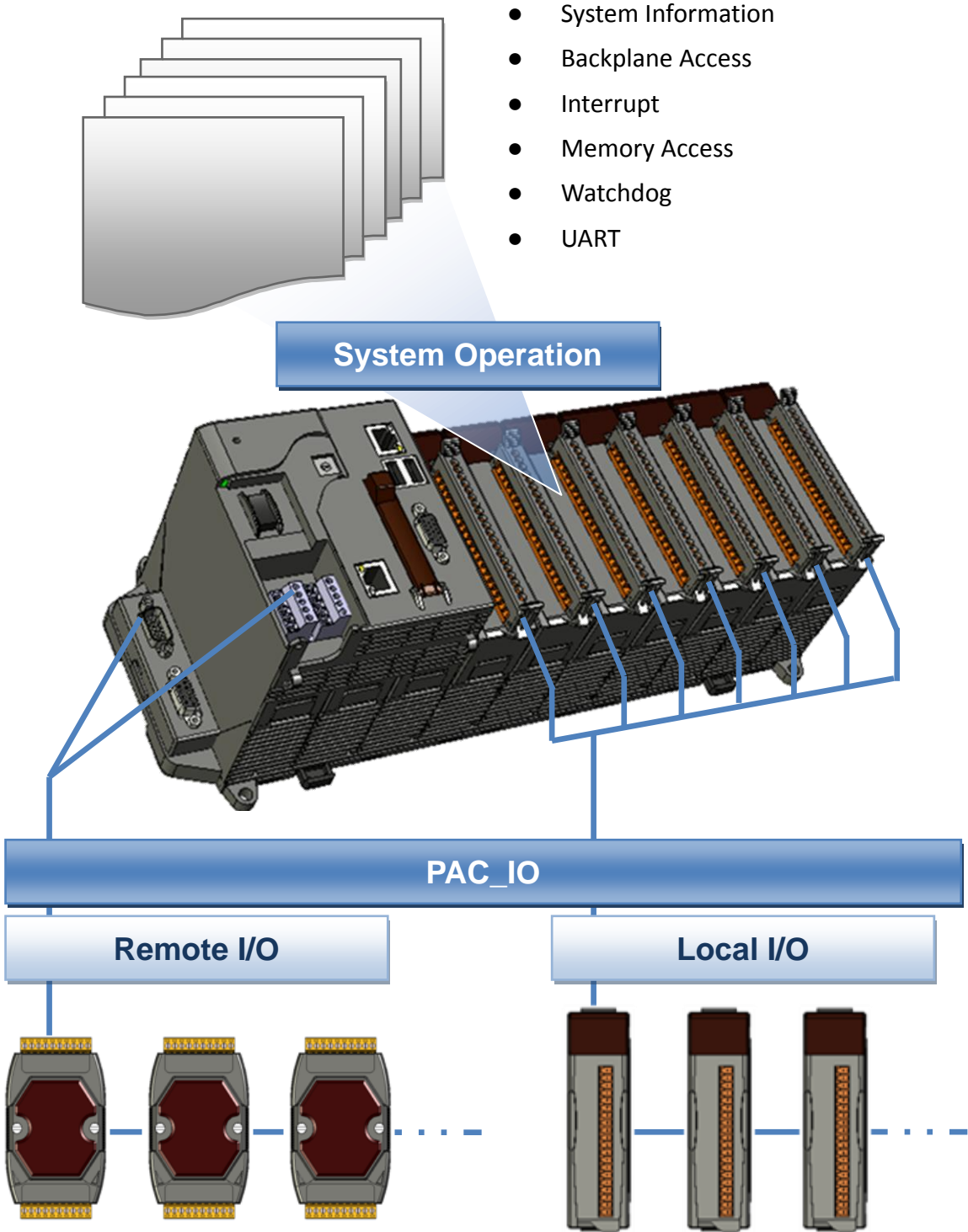

- **System Information Reference**

Provide reference information for the system status.

- **Backplane Access Reference**

Provide reference information for the backplane access APIs.

- **Interrupt Reference**

Provide reference information for the Interrupt APIs

- **Memory Access Reference**

Provide reference information for the memory R/W APIs, including EEPROM and SRAM.

- **Watchdog Reference**

Provide reference information for the watchdog APIs, including hardware watchdog and OS watchdog.

- **Uart Reference**

Provide reference information for the Uart APIs.

- **PAC_IO Reference**

Provide reference information for IO APIs, including local and remote.

In additions, no matter 8K or 87K modules use the same API.

- **Error Handling API Reference**

Provide reference information for error handling.

XPacSDK Plug-in for Development Tools for XP-8000 Series

This SDK for XP-8000 series supports several languages including C/C++/MFC/.NET/VB/Delphi. For different languages, they have to be called by different methods. Therefore, in this section, we provide a brief tutorial on how to render XPacSDK from these programming languages as you need.

C/C++/MFC (for XP-8000 Series only)

Required Libraries and Header files

To develop your C/C++/MFC program, you must use the appropriate libraries and header files for targeting your program.

1. XPacSDK.h
2. XPacSDK.lib
3. XPacSDK.dll (your execution file should be put in the same directory as the XPacSDK.dll)

How to

Step 1: Include XPacSDK

```
// DemoDlg.cpp : implementation file
//

#include "stdafx.h"
#include "Demo.h"
#include "DemoDlg.h"

#include "XPacSDK.h"
```

Step 2: Add XPacSDK.lib into your project

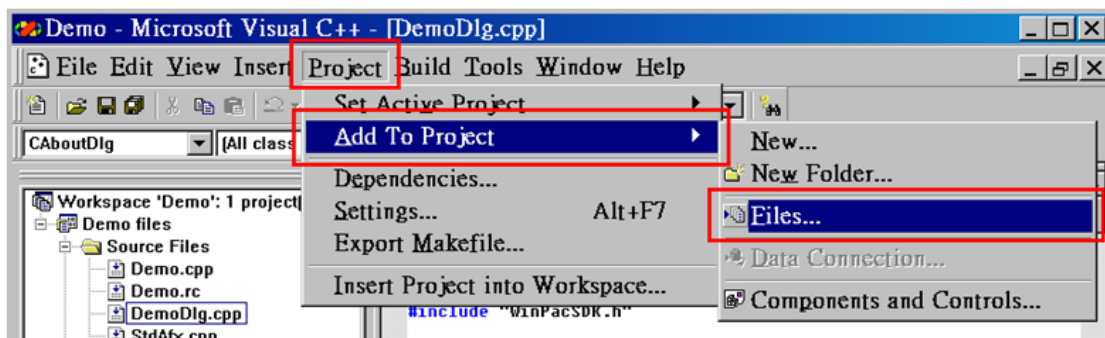

C# (for XP-8000 Series only)

Required Libraries and Header files

To develop your C# program, you must use the appropriate libraries and header files for targeting your program.

1. XPacNet.dll
2. XPacSDK.dll (your execution file should be put in the same directory as the XPacNet.dll and XPacSDK.dll)

How to

Step 1: Add reference, XPacNET.dll, into your project

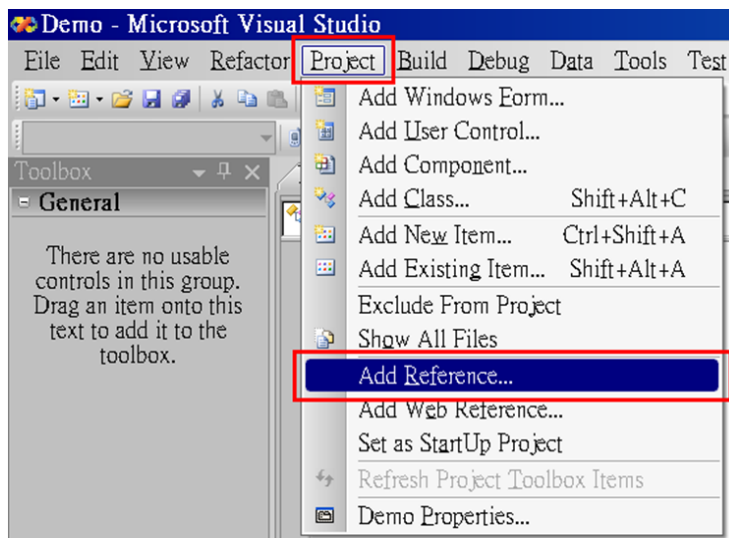

Step 2: Using XPacNET

```
using System;  
using System.Collections.Generic;  
using System.ComponentModel;  
using System.Data;  
using System.Drawing;  
using System.Linq;  
using System.Text;  
using System.Windows.Forms;  
using XPacNET;
```

VB.NET (for XP-8000 Series only)

Required Libraries and Header files

To develop your VB.NET program, you must use the appropriate libraries and header files for targeting your program.

1. XPacNet.dll
2. XPacSDK.dll (your execution file should be put in the same directory as the XPacNet.dll and XPacSDK.dll)

How to

Step 1: Add reference, XPacNET.dll, into your project

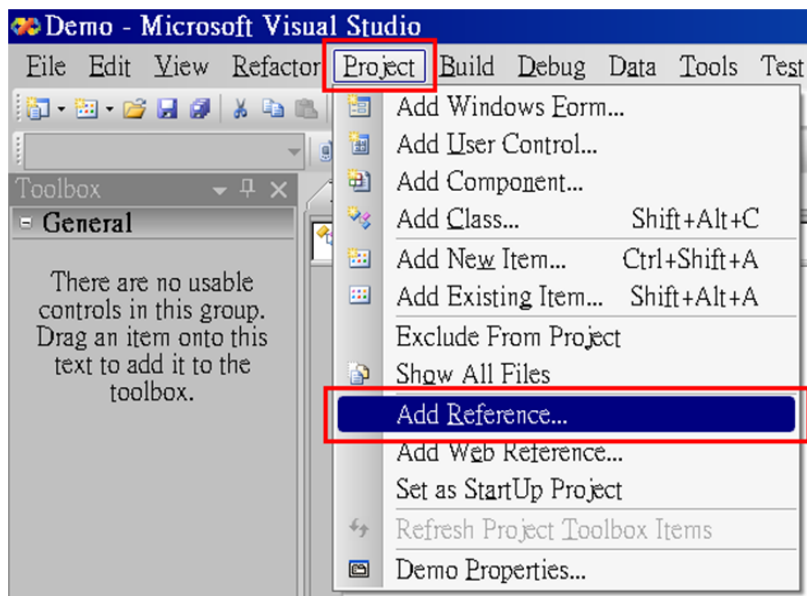

Step 2: Imports XPacNET

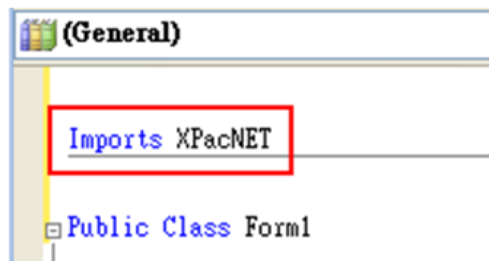

VB (for XP-8000 Series only)

Required Libraries and Header files

To develop your VB program, you must use the appropriate libraries and header files for targeting your program.

1. XPacSDK.bas
2. XPacSDK.dll (your execution file should be put in the same directory as the XPacSDK.dll)

How to

Step 1: Add module, XPacSDK.bas, into your project

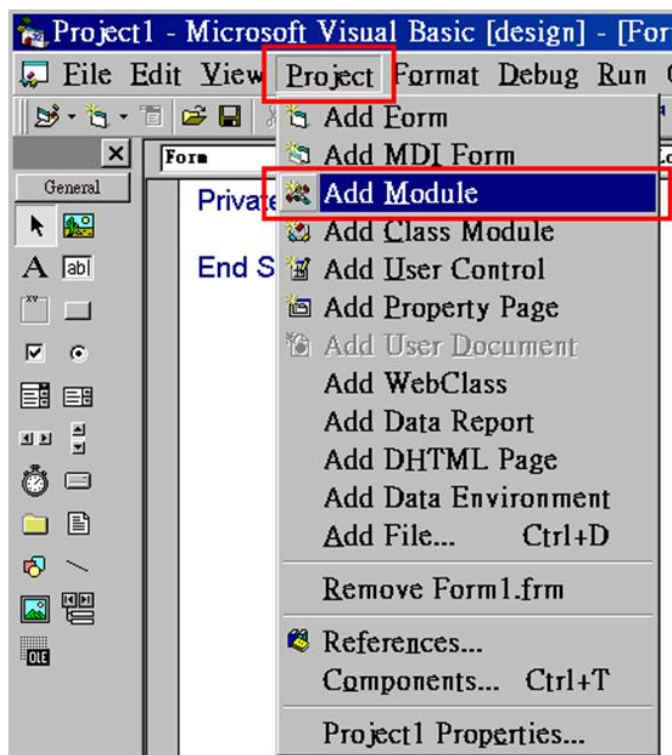

Step 2: Then you can use the APIs of XPacSDK in your project.

Delphi (for XP-8000 Series only)

Required Libraries and Header files

To develop your Delphi program, you must use the appropriate libraries and header files for targeting your program.

1. XPacSDK.pas
2. XPacSDK.dll (your execution file should be put in the same directory as the XPacSDK.dll)

How to

Step 1: Add unit, XPacSDK.pas, into your project

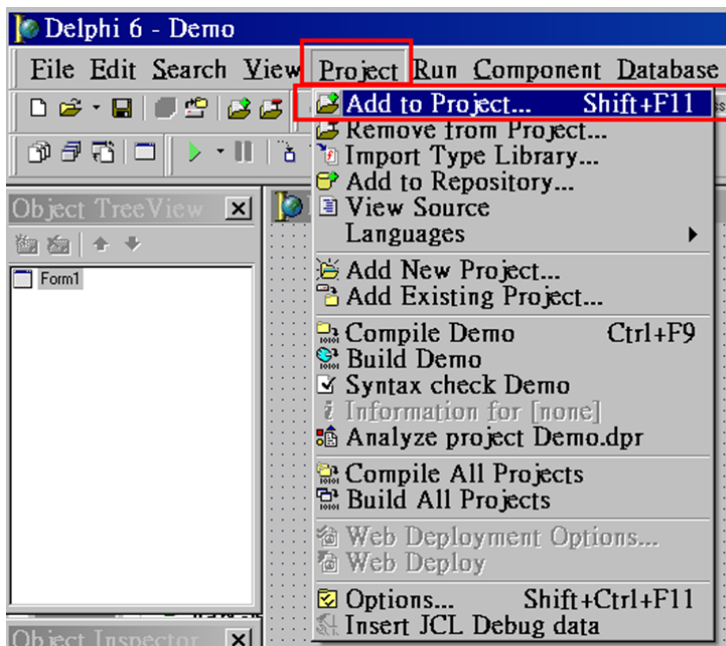

Step 2: Uses XPacSDK.pas.

```
unit Unit1;  
  
interface  
  
uses  
  Windows, Messages, SysUtils, Va  
  Dialogs, XPacSDK;  
  
type  
  TForm1 = class(TForm)
```

Borland C++ Builder (BCB) (for XP-8000 Series only)

Required Libraries and Header files

To develop your Borland C++ Builder (BCB) program, you must use the appropriate libraries and header files for targeting your program.

1. XPacSDK_BCB.lib
2. XPacSDK.h
3. XPacSDK.dll (your execution file should be put in the same directory as the XPacSDK.dll)

How to

Step 1: Include XPacSDK.h

```
#include <vcl.h>
#pragma hdrstop

#include "Unit1.h"
#include "XPacSDK.h"
```

Step 2: Add XPacSDK_BCB.lib into your project

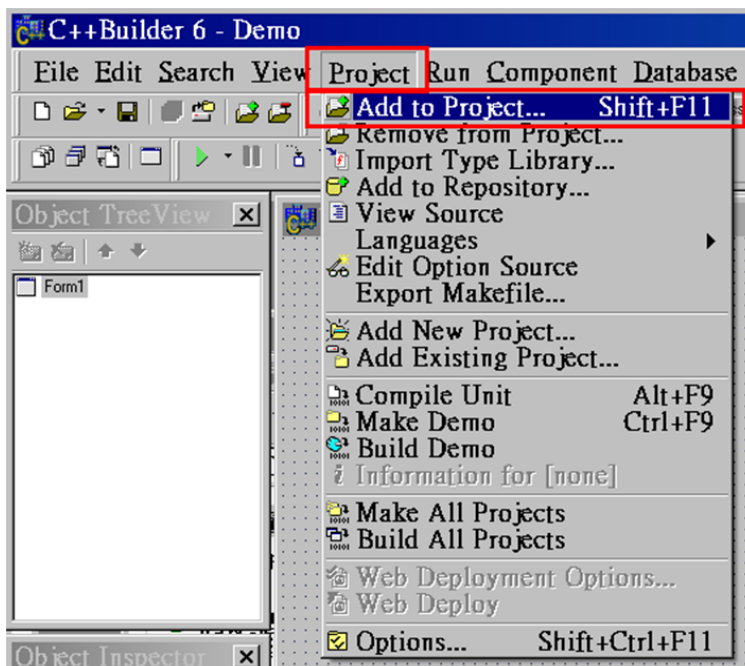

XPacSDK Plug-in for Development Tools for XPAC_CE Series

Before developing your program by using this SDK on XPAC_CE series, you have to install XPacSDK_CE.msi in your desktop. The XPacSDK_CE is necessary for application developers targeting XPAC_CE. The corresponding XPacSDK.nsi must be installed on the Host PC.

To install the XPacSDK.msi, please perform the following steps:

Step 1: Run the “XPacSDK_CE.msi

You can download and unzip from:

XP-8000-CE6

ftp://ftp.icpdas.com/pub/cd/xp-8000-ce6/sdk/platformsdk/xpacsdk_ce_xxx.msi

XP-8000-Atom-CE6

ftp://ftp.icpdas.com/pub/cd/xpac-atom-ce6/sdk/platformsdk/xpacsdk_ce_xxx.msi

Step 2: Follow the prompts until the XPacSDK.msi installation process is complete.

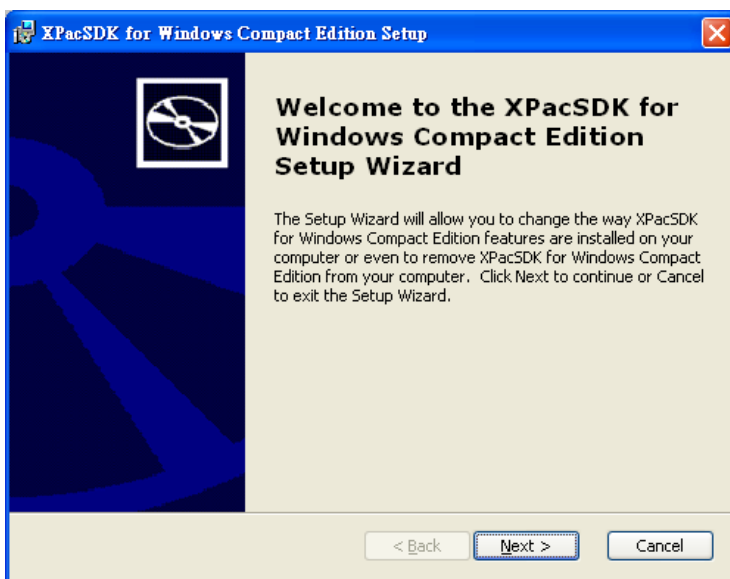

C/C++/MFC (for XPAC_CE Series only)

Required Libraries and Header files

To develop your C/C++/MFC program, you must use the appropriate libraries and header files for targeting your program.

1. XPacSDK_CE.h
2. XPacSDK_CE.lib
3. XPacSDK_CE.dll (your execution file should be put in the same directory as the XPacSDK_CE.dll)

How to

Step 1: Create a new project by using Visual Studio 2005/2008

Step 2: Select Smart Device

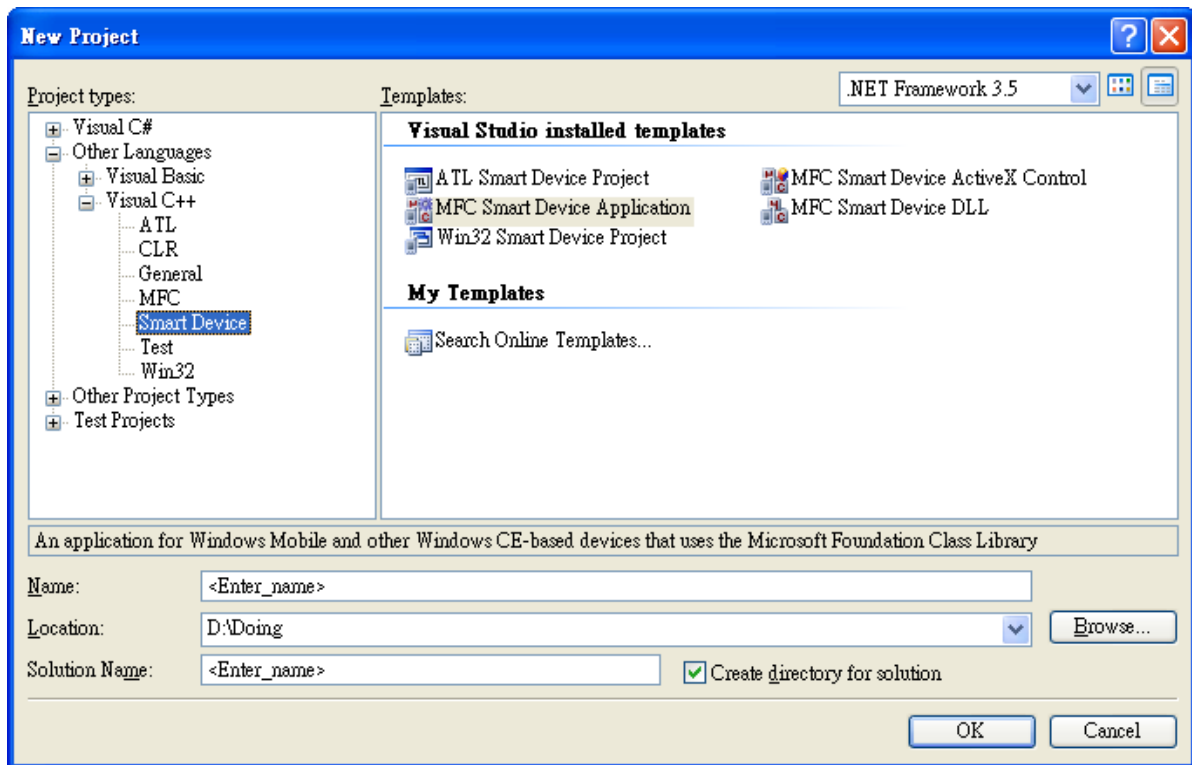

Step 3: Select platform, XPacSDK_CE, to be added to the current project

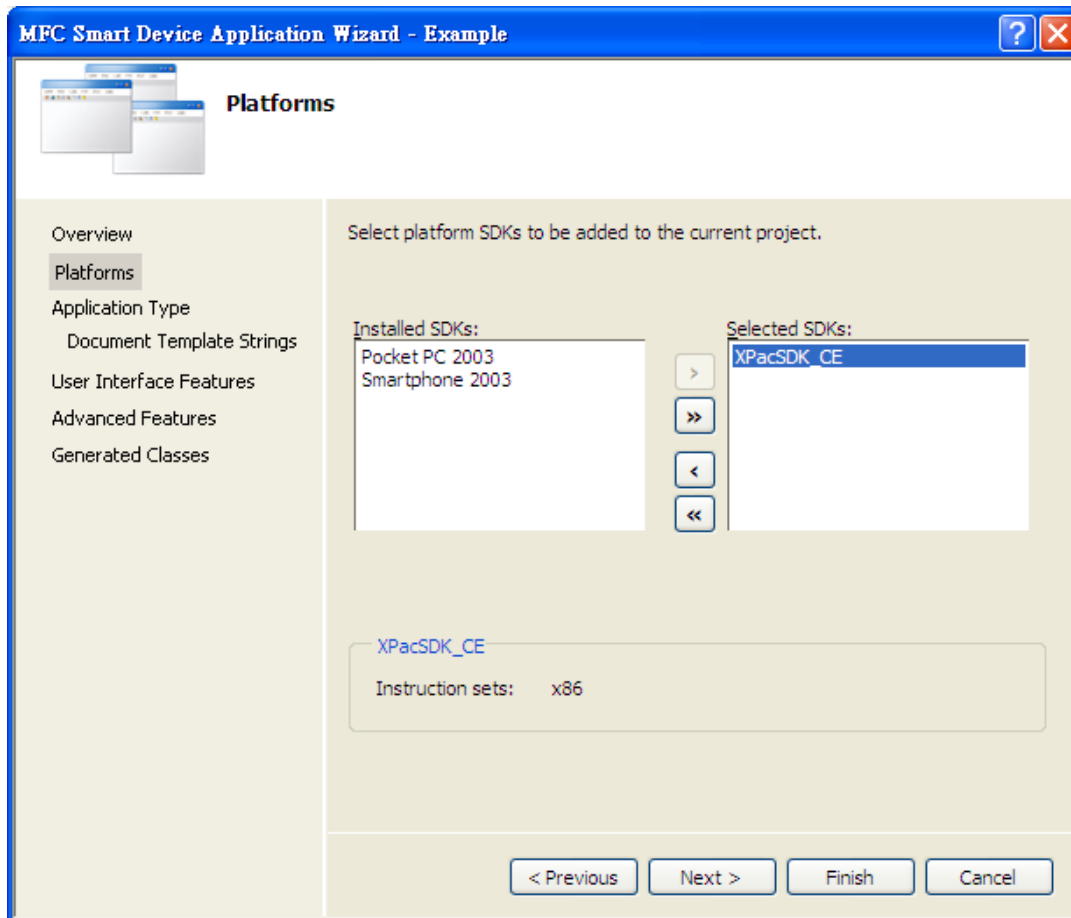

Step 4: On the configuration toolbar, select the XPacSDK_CE(x86)

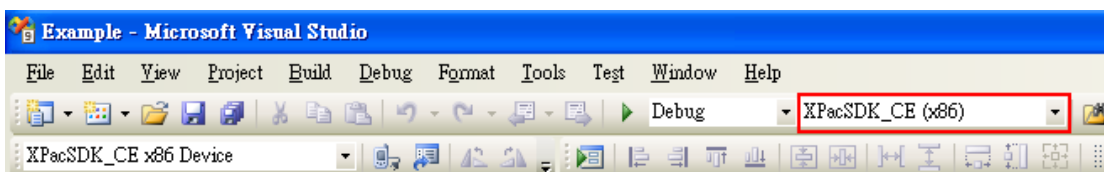

Step 5: Include XPacSDK_CE.h

Step 6: Include XPacSDK_CE.lib

C# (for XPAC_CE Series only)

Required Libraries

To develop your C# program with XPacSDK_CE, you have to use the appropriate libraries and use DllImport to make calls to XPacSDK_CE.dll which is native code from a managed application.

- XPacSDK_CE.dll (your execution file should be put in the same directory as the XPacSDK_CE.dll)

How to

1. Usign DllImport:

Step 1: Create a new project by using Visual Studio 2005/2008

Step 2: Select Smart Device

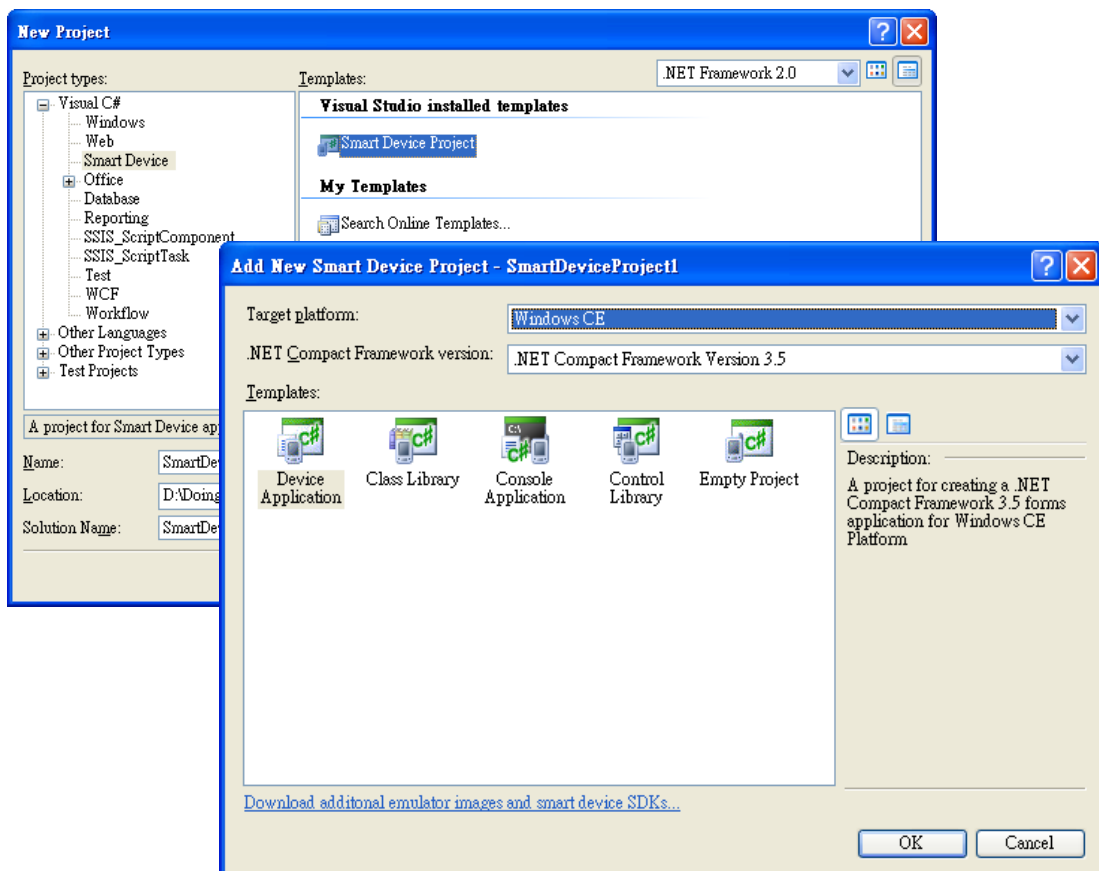

Step 3: In order to use “DllImport”, you should using System.Runtime.InteropServices, and then implement the function which you want to call in the XPacSDK_CE

For example, you want use pac_WriteDO in .NET project directly.

[In XPacSDK_CE.h file]

```
XPAC_API BOOL pac_WriteDO(HANDLE hPort, int slot, int iDO_TotalCh,
DWORD IDO_Value);
```

[In your .NET project]

- Added this line in your project:

```
using System.Runtime.InteropServices;
```

- Declare this function as following:

```
[DllImport("XPacSDK_CE.dll", EntryPoint = "pac_WriteDO")]
```

```
public extern static bool pac_WriteDO(IntPtr hPort, int slot, int
iDO_TotalCh, uint lDO_Value);
```

- Then you can use this function, pac_WriteDO, in your .NET project.

[Code Snippet]

```
using System.Windows.Forms;

using System.Runtime.InteropServices;

namespace WindowsFormsApplication2
{
    public partial class Form1 : Form
    {
        [DllImport("XPacSDK_CE.dll", EntryPoint = "pac_WriteDO")]
        public extern static bool pac_WriteDO(IntPtr hPort, int slot, int
iDO_TotalCh, uint lDO_Value);

        public Form1()
        {
            InitializeComponent();
        }

        private void button1_Click(object sender, EventArgs e)
        {
            pac_WriteDO((IntPtr)0, 1, 16, 0xff);
        }
    }
}
```

2. XPacNET.cs:

We support a C# file, XPacNET.cs, which have declared all the functions of XPacSDK_CE. You could just add it in your .NET project, and then you can use these functions easily.

- XPacNET.cs (which is located at
CD root\XP-8000-CE6\SDK\ (in the companion CD)
CF Card root\SDK\
ftp://ftp.icpdas.com/pub/cd/xpac_ce/xp-8000-ce6/sdk

Step 1: Create a new project by using Visual Studio 2005/2008

Step 2: Select Smart Device

Step 3: Add the XPacNET.cs into your project, and using XPacNET

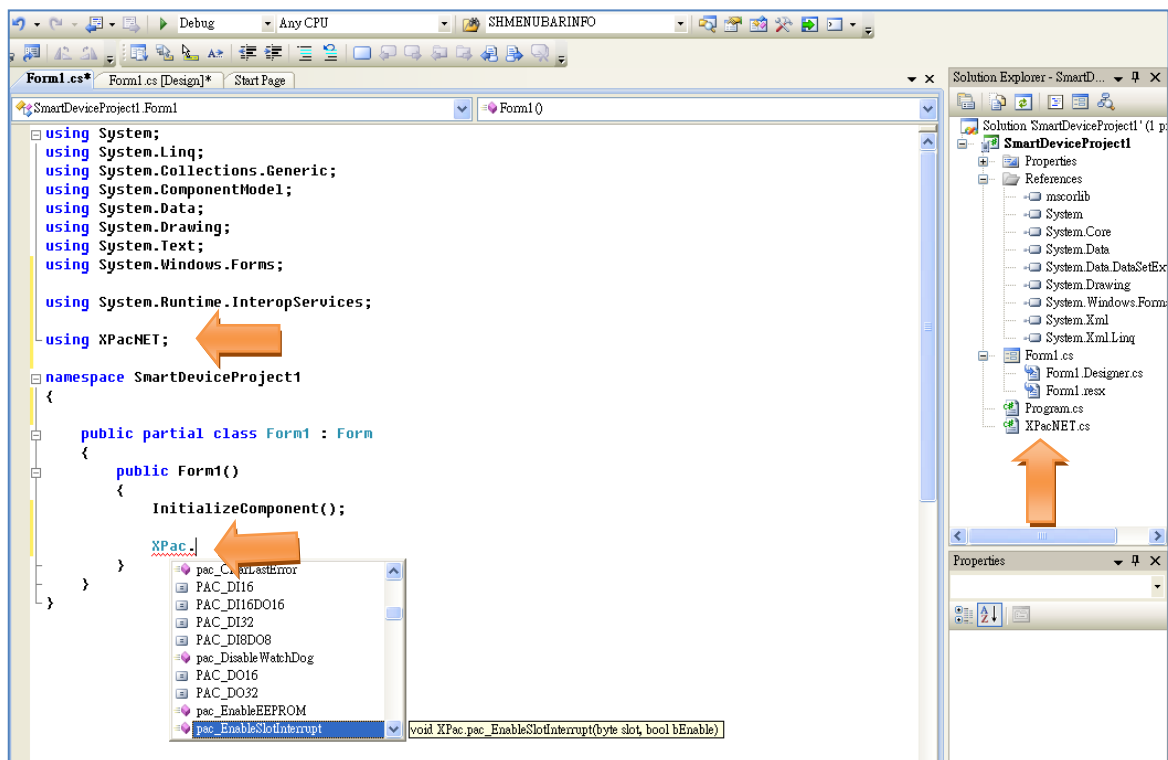

3. Using XPacNet.dll to replace the XpacNet.cs

XPacNet.dll is a .net Compact framework SDK and it is built from Xpacnet.cs and the other .cs file. XpacNet.dll isn't used for #C program but also used for VB.net program.

- XPacNET.dll (which is located at

CD root\XP-8000-CE6\SDK\XPacNET (in the companion CD)

CF Card root\SDK\XPacNET

<ftp://ftp.icpdas.com/pub/cd/xp-8000-ce6/sdk/xpacnet>

Step 1: Create a new project by using Visual Studio 2005/2008

Step 2: Select Smart Device

Step 3: Add the XPacNET.dll into the references of the project, and using XPacNET

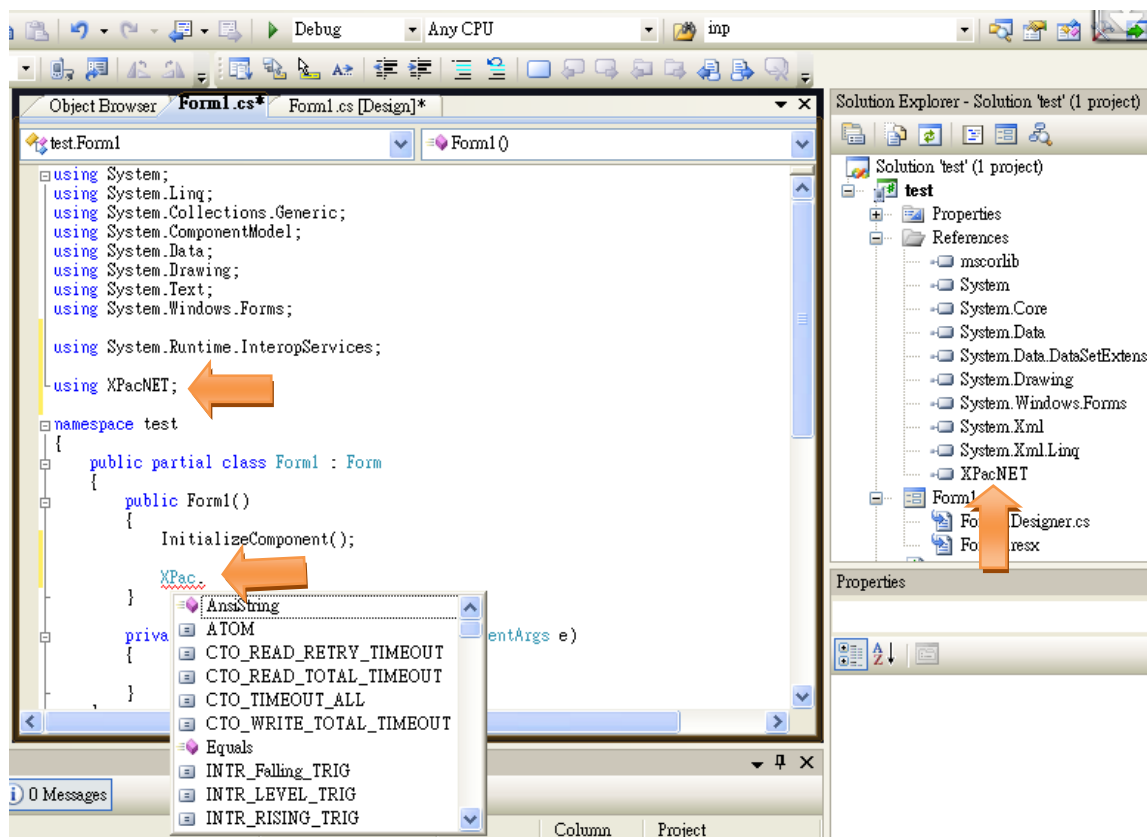

XP-8000-CE6

Refer to the chapter 4 on xp-8000-ce6 user manual for more details

ftp://ftp.icpdas.com/pub/cd/xp-8000-ce6/document/user_manual/

XP-8000-Atom-CE6

Refer to the chapter 4 on xp-8000-Atom-ce6 user manual for more details

ftp://ftp.icpdas.com/pub/cd/xpac-atom-ce6/document/user_manual/

1. System Information API

System Information Reference

System operations include basic operation, such as reboot and changing slot and version display, including OS, SDK, Serial Number, and Mac address. The following topics describe how you can show the system information, or other basic operation programmatically using the system functions.

Supported Modules

The following shows the overview of the system functions which are available with XPAC.

Functions\Models	XP-8000 (WES)	XP-8000-CE6	XP-8000-Atom (WES)	XP-8000-Atom -CE6
pac_GetModuleName	Y	Y	Y	Y
pac_GetRotaryID	Y	Y	Y	Y
pac_GetSerialNumber	Y	Y	Y	Y
pac_GetSDKVersion	Y	Y	Y	Y
pac_ChangeSlot	Y	Y	Y	Y
pac_CheckSDKVersion	Y	Y	Y	Y
pac_ModuleExists	Y	Y	Y	Y
pac_GetOSVersion	X	Y	X	Y
pac_GetMacAddress	X	Y	X	Y
pac_ReBoot	X	Y	X	Y
Pac_GetCPUVersion	Y	Y	Y	Y
Pac_EnableLED	X	X	Y	Y

Function List

The following functions are used to retrieve or set system information.

Function	Description
pac_GetModuleName	This function is used to retrieve the name of an 8000 series I/O module, which is plugged into a specific I/O slot in the devices. This function supports the collection of system hardware configurations.
pac_GetRotaryID	This function retrieves the rotary switch ID.
pac_GetSerialNumber	This function retrieves the serial number.
pac_GetSDKVersion	This function retrieves the SDK version.
pac_ChangeSlot	This function specifies the slot from one to another.
pac_CheckSDKVersion	This function specifies the application not access the XPacSDK.dll which is wrong version.
pac_ModuleExists	This function specifies the IO module whether exist or not, no matter the module is local or remote.
pac_GetOSVersion	This function retrieves OS version.
pac_GetMacAddress	This function retrieves the Mac address.
pac_ReBoot	This function reboots the device.
Pac_GetCPUVersion	This function retrieves the CPU version.
Pac_EnableLED	This function decides the LED turning on or not.

1.1. pac_GetModuleName

This function is used to retrieve the name of an 8000 series I/O module, which is plugged into a specific I/O slot in the devices. This function supports the collection of system hardware configurations.

Syntax

C++

```
int pac_GetModuleName(  
    BYTE slot,  
    LPSTR strName  
);
```

Parameter

slot

[in] Specify the slot number where the I/O module is plugged into.

strName

[out] The pointer to a buffer to receive the name of the I/O module.

Return Values

Return 255 if 87k modules, otherwise 8k or undefined.

Examples

[VC/VS]

```
byte slot = 1;
char strName[MAX_NAME_SIZE];
pac_GetModuleType(slot, strName);
```

[C#] for XP-8000 series only

```
byte slot = 1;
string strName;
int ModuleType = 0;
ModuleType = XPac.pac_GetModuleName(slot, ref strName);
// because of calling by reference, you should add key word, ref.
```

```
// For this API, there are two overloading for .NET. First is above, another
// is below, whose return value is Module Name, not Module type.
byte slot = 1;
string strName;
strName = XPac.pac_GetModuleName(slot);
```

1.2. pac_GetRotaryID

This function retrieves the rotary switch ID.

Syntax

C++

```
int pac_GetRotaryID();
```

Parameter

None

Return Values

Return the rotary ID.

Examples

[VC/VS]

```
int RotaryID;  
RotaryID = pac_GetRotaryID();
```

[C#] for XP-8000 series only

```
int RotaryID;  
RotaryID = XPac.pac_GetRotaryID();
```

1.3. pac_GetSerialNumber

This function retrieves the serial number.

Syntax

C++

```
void pac_GetSerialNumber(  
    LPSTR SerialNumber  
);
```

Parameter

SerialNumber

[out] Pointer to a variable that specifies the serial number.

Return Values

None

Examples

[VC/VS]

```
char SN[32];  
pac_GetSerialNumber(SN);
```

[C#] for XP-8000 series only

```
string SN;  
SN = XPac.pac_GetSerialNumber();
```

Remark

If the retrieved value is empty, means the function executes failure or the device is not valid product.

1.4. pac_GetSDKVersion

This function retrieves the SDK version.

Syntax

C++

```
void pac_GetSDKVersion(  
    LPSTR sdk_version  
);
```

Parameter

sdk_version

[out] Pointer to a variable that specifies the SDK version.

Return Values

None

Examples

[VC/VS]

```
char SDK[32];  
pac_GetSDKVersion(SDK);
```

[C#] for XP-8000 series only

```
string XPacSDK;  
string XPacNET;  
XPacSDK = XPac.pac_GetXPacSDKVersion(); //retrieving XPacSDK version  
XPacNET = XPac.pac_GetXPacNetVersion(); //retrieving XPacNET version  
//In .net, ths API is different with VC. And there are two API,  
//pac_GetXPacSDKVersion and pac_GetXPacNetVersion.
```

1.5. pac_ChangeSlot

This function specifies the slot from one to another.

Syntax

C++

```
void pac_ChangeSlot(  
    BYTE slotNo  
);
```

Parameter

slotNo

[in] Specifies which slot.

Return Values

None

Examples

[VC/VS]

```
BYTE slot;
HANDLE hPort;
BOOL ret;
char buf[Length];
hPort = uart_Open("");
pac_ChangeSlot(slot);
// Change to the slot which the 87k modules plug in
ret = uart_SendCmd(hPort, "$00M", buf);
// $00M: ask the device name
```

[C#] for XP-8000 series only

```
BYTE slot;
IntPtr hPort;
bool ret;
string buf;
hPort = XPac.uart_Open(XPac.AnsiString(""));
XPac.pac_ChangeSlot(slot);
// Change to the slot which the 87k modules plug in
ret = XPac.uart_SendCmd(hPort, XPac.AnsiString("$00M"), buf);
```

Remark

When you use uart API and the IO modules located as slots.

You have to call pac_ChangeSlot to change the slot.

Besides, other low level operations may use pac_ChangeSlot to change the slot.

If you just use PAC_IO APIs, you needn't care about this.

1.6. pac_CheckSDKVersion

This function specifies the application not access the XPacSDK.dll which is wrong version.

Syntax

C++

```
BOOL pac_CheckSDKVersion(  
    DWORD version  
);
```

Parameter

version

[in] Specifies SDK version.

If your application should use the version, 1.0.0.1, or newer, your parameter should be 0x01000001.

Return Values

Return TRUE, if the version is correctly.

Otherwise, return false.

Examples

[VC/VS]

```
//.....  
//Added this API in the begin of your application  
BOOL bVersion;  
bVersion = pac_CheckSDKVersion( 0x01000001);  
//if your application should use newer than version 1.0.0.1  
if(!bVersion)  
{  
    MessageBox("The XPacSDK.dll version is wrong");  
    // display some warning and close the application  
}
```

[C#] for XP-8000 series only

```
//.....  
// Added this API in the begin of your application  
bool bVersion;  
bVersion = XPac.pac_CheckSDKVersion( 0x01000001);  
  
// if your application should use newer than version 1.0.0.1  
if(!bVersion)  
{  
    MessageBox.show("The XPacSDK.dll version is wrong");  
    // display some warning and close the application  
}
```

1.7. pac_ModuleExists

This function specifies the IO module whether exist or not, no matter the module is local or remote.

Syntax

C++

```
BOOL pac_ModuleExists(  
    HANDLE hPort  
    BYTE slot  
);
```

Parameter

hPort

[in] The serial port HANDLE opened by `uart_Open()`.

If your IO module is located at local, this Parameter should be 0.

Slot

[in] The slot in which module is to check exists or not.

If the IO module is remote, please input the module's ID.

Return Values

Return TRUE, if the module exists.

Otherwise, return false.

Examples

[VC/VS]

```
//.....  
//if you want to check a module which is in the slot 5  
BOOL bExist;  
bExist = pac_ModuleExists(0, 5);  
if(bExist)  
{  
    MessageBox("The module exist !");  
}  
else  
{  
    MessageBox("The module unexist !");  
}
```

[C#] for XP-8000 series only

```
//.....  
//if you want to check a module which is in the slot 5  
bool bExist;  
bExist = XPac.pac_ModuleExists(0, 5);  
if(bExist)  
{  
    MessageBox.show("The module exist !");  
}  
else  
{  
    MessageBox.show("The module unexist !");  
}
```

1.8. pac_GetOSVersion (for XPAC_CE series only)

This function retrieves OS version.

Syntax

C++

```
void pac_GetOSVersion(  
    LPSTR os_version  
);
```

Parameter

LPSTR

[out] Pointer to a variable that specifies the OS version.

Return Values

None.

Examples

[VS]

```
char OS[32];  
pac_GetOSVersion(OS);
```

1.9. pac_GetMacAddress (for XPAC_CE series only)

This function retrieves the Mac address.

Syntax

C++

```
void pac_GetMacAddress(  
    BYTE LAN,  
    LPSTR MacAddr  
);
```

Parameter

LAN

[in] Specifies which LAN.

LPSTR

[out] Pointer to a variable that specifies the MAC address.

Return Values

None.

Examples

[VS]

```
char MAC[32];  
BYTE LAN = 1;  
pac_GetMacAddress(LAN, MAC);
```

1.10. pac_ReBoot (for XPAC_CE series only)

This function reboots the device.

Syntax

C++

```
void pac_ReBoot();
```

Parameter

None.

Return Values

None.

Examples

[VS]

```
pac_ReBoot();
```

1.11. Pac_GetCPUVersion

This function retrieves the CPU version.

Syntax

C++

```
void pac_GetCPUVersion(  
    LPSTR cpu_version  
);
```

Parameter

cpu_version

[out] The pointer to a buffer to receive the cpu version.

Return Values

None

Examples

[VC]

```
char CPU[32];  
pac_GetCPUVersion(CPU);
```

[C#]

```
string CPU = XPac.pac_GetCPUVersion();
```

1.12. Pac_EnableLED (for XPAC_Atom series only)

This function decides the LED turning on or not.

Syntax

C++

```
void pac_EnableLED(  
    int pin,  
    bool bFlag  
);
```

Parameter

pin

0: L1 LED

1: L2 LED

bFlag

True: Turn on the LED

False: Turn off the LED

Return Values

None

Examples

[VC]

```
pac_EnableLED(0,TRUE);
```

[C#]

```
XPac.pac_EnableLED(0,true);
```

2. Backplane Access API

Backplane Access Reference

Backplane operations include hot plug, interrupt and backplane information, such as NET ID and backplane version. The following topics describe how you can show the backplane information, and access the backplane by using these functions.

Supported Modules

The following shows the overview of the backplane functions which are available with XPAC.

Functions\Models	XP-8000 (WES)	XP-8000-CE6	XP-8000-Atom (WES)	XP-8000-Atom -CE6
pac_GetDIPSwitch	Y	Y	Y	Y
pac_GetSlotCount	Y	Y	Y	Y
pac_EnableRetrigger	Y	Y	Y	Y
pac_GetBackplaneID	Y	Y	Y	Y
pac_GetBatteryLevel	Y	Y	Y	Y

Function List

The following functions are used to retrieve or set backplane functions.

Function	Description
pac_GetDIPSwitch	This function retrieves the dip switch.
pac_GetSlotCount	This function retrieves the number of slot.
pac_EnableRetrigger	This function decides the retrigger turning on or not.
pac_GetBackplaneID	This function retrieves the backplane ID.
pac_GetBatteryLevel	This function retrieves the backplane battery status.

2.1. pac_GetDIPSwitch

This function retrieves the dip switch.

Syntax

C++

```
int pac_GetDIPSwitch();
```

Parameter

None

Return Values

The return value specifies the dip switch.

Examples

[VC/VS]

```
int iDipSwitch;  
iDipSwitch = pac_GetDIPSwitch();
```

[C#] for XP-8000 series only

```
int iDipSwitch;  
iDipSwitch = XPac.pac_GetDIPSwitch();
```

2.2. pac_GetSlotCount

This function retrieves the number of slot.

Syntax

C++

```
int pac_GetSlotCount();
```

Parameter

None

Return Values

The return value is the number of the slot of this device.

Examples

[VC/VS]

```
int wSlot;  
wSlot = pac_GetSlotCount();
```

[C#] for XP-8000 series only

```
int wSlot;  
wSlot = XPac.pac_GetSlotCount();
```

2.3. pac_EnableRetrigger

This function decides the retrigger turning on or not.

Syntax

C++

```
void pac_EnableRetrigger(  
    BYTE iValues  
);
```

Parameter

iValues

[in] Specify the retrigger value, 0~255, unit= 10 microsecond. (0 means disable retrigger function)

Return Values

None

Examples

None

Remark

The retrigger mechanism is used when the below situation occurred.

If an interrupt is sent but not be serviced, the retrigger function will send an interrupt again. This operation will continue until the interrupt has been serviced.

2.4. pac_GetBackplaneID

This function retrieves the backplane ID.

Syntax

C++

```
void pac_GetBackplaneID(  
    LPSTR backplane_version  
);
```

Parameter

backplane_version

[out] The pointer to a buffer to receive the backplane version.

Return Values

None

Examples

[VC/VS]

```
char Backplane[32];  
pac_GetBackplaneID(Backplane);
```

[C#] for XP-8000 series only

```
string Backplane = XPac.pac_GetBackplaneID();
```

2.5. pac_GetBatteryLevel

This function retrieves the backplane battery status.

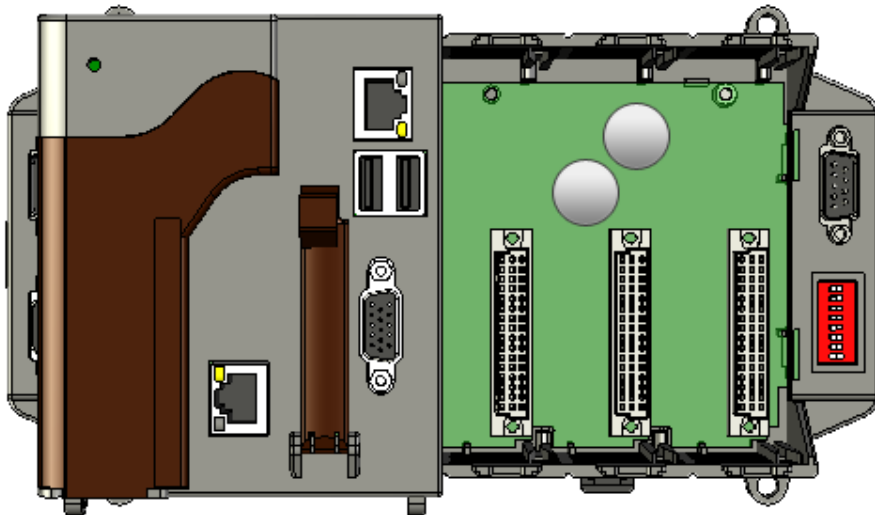

Syntax

C++

```
int pac_GetBatteryLevel(  
int nBattery  
);
```

Parameter

nBattery

[in] Specifies the index of battery.

1 means first battery.

2 means second battery.

3 means RTC battery. (For XPAC_Atom series only)

Return Values

1 means high voltage.

0 means low voltage.

Examples

[VC/VS]

```
int nBattery;  
int index = 1;  
nBattery = pac_GetBatteryLevel(index);
```

3. Interrupt API

Interrupt Reference

Interrupt operations include basic management operations, such as interrupt done, enable and disable interrupt. The following topics describe how you can operate interrupt programmatically using the interrupt functions.

Interrupt Flow

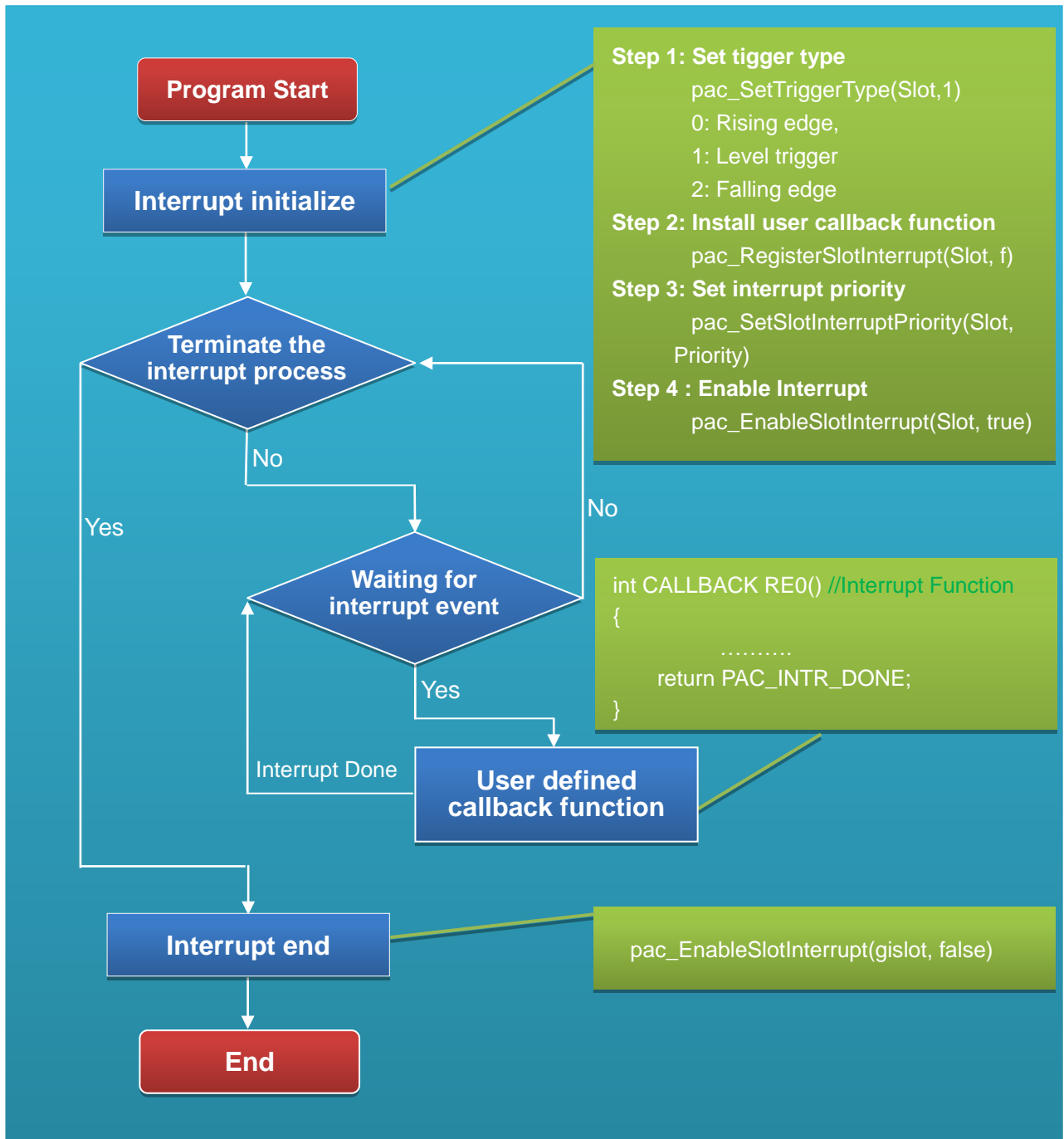

Supported Modules

The following shows the overview of the interrupt functions which are available with XPAC.

Functions\Models	XP-8000 (WES)	XP-8000-CE6	XP-8000-Atom (WES)	XP-8000-Atom -CE6
pac_RegisterSlotInterrupt	Y	Y	Y	Y
pac_UnregisterSlotInterrupt	Y	Y	Y	Y
pac_EnableSlotInterrupt	Y	Y	Y	Y
pac_SetSlotInterruptPriority	Y	Y	Y	Y
pac_InterruptInitialize	Y	Y	Y	Y
pac_GetSlotInterruptEvent	Y	Y	Y	Y
pac_SetSlotInterruptEvent	Y	Y	Y	Y
pac_SetTriggerType	Y	Y	Y	Y
pac_GetSlotInterruptID	Y	Y	Y	Y
pac_InterruptDone	Y	Y	Y	Y

Function List

The following functions are used to retrieve or set interrupt functions.

Function	Description
pac_RegisterSlotInterrupt	This function registers slot interrupt service route and turns on slot interrupt.
pac_UnregisterSlotInterrupt	This function unregisters slot interrupt service route and disables a hardware interrupt as specified by its interrupt identifier.
pac_EnableSlotInterrupt	This function performs hardware operations necessary to enable the specified hardware interrupt
pac_SetSlotInterruptPriority	This function sets the priority for a real-time thread on a thread by thread basis.
pac_InterruptInitialize	This function initializes a slot interrupt with the kernel. This initialization allows the slot to register an event and enable the interrupt.
pac_GetSlotInterruptEvent	This function retrieves the slot event handle which registered by pac_InterruptInitialize.
pac_SetSlotInterruptEvent	This function allows a device driver to assign the slot event handle.
pac_SetTriggerType	This function can assign the pulse trigger type for separate slot.
pac_GetSlotInterruptID	This function retrieves the slot interrupt ID.
pac_InterruptDone	This function signals to the kernel that interrupt processing has been completed.

3.1. pac_RegisterSlotInterrupt

This function registers slot interrupt service route and turns on slot interrupt.

Syntax

C++

```
BOOL pac_RegisterSlotInterrupt(  
    BYTE slot,  
    PAC_CALLBACK_FUNC f  
);
```

Parameter

slot

[in] Specify the index of slot.

f

a call back function.

Return Values

Return TRUE if success, otherwise return FALSE.

Examples

[VC/VS]

```
int slot = 3; // if slot is 3
int CALLBACK slot_callback_proc()
{
    // do something
    return true;
    // if return true, SDK will do pac_InterruptDone automatically
    // else, users should do pac_InterruptDone by themselves if needed.
    // if interrupt type is level trigger, no matter return true or false,
    // needn't add pac_InterruptDone and it will work correctly.
}
void CIntrDlg::OnButton1()
{
    pac_RegisterSlotInterrupt(slot, slot_callback_proc);
    pac_EnableSlotInterrupt(slot, true); // enable slot interrupt
}

void CIntrDlg::OnButton2()
{
    pac_EnableSlotInterrupt(slot, false); // disable slot interrupt
    pac_UnregisterSlotInterrupt(slot); // unregister slot interrupt
}
```

Remark

Default trigger type is level trigger.

For XP-8000 series, only support level trigger type.

3.2. pac_UnregisterSlotInterrupt

This function unregisters slot interrupt service route and disables a hardware interrupt as specified by its interrupt identifier.

Syntax

C++

```
BOOL pac_UnregisterSlotInterrupt(  
    BYTE slot  
);
```

Parameter

slot

[in] Specify the index of slot.

Return Values

Return TRUE if success, otherwise return FALSE.

Examples

[VC/VS]

```
int slot = 3; // if slot is 3
int CALLBACK slot_callback_proc()
{
    // do something
    pac_InterruptDone(slot);
    return false;
    // if return true, SDK will do pac_InterruptDone automatically
    //else, users should do pac_InterruptDone by themselves if needed
    // if interrupt type is level trigger, no matter return true or false,
    // needn't add pac_InterruptDone and it will work correctly.
}
void CIntrDlg::OnButton1()
{
    pac_RegisterSlotInterrupt(slot, slot_callback_proc);
    pac_EnableSlotInterrupt(slot, true);    // enable slot interrupt
}
void CIntrDlg::OnButton2()
{
    pac_EnableSlotInterrupt(slot, false);  // disable slot interrupt
    pac_UnregisterSlotInterrupt(slot);     // unregister slot interrupt
}
```

3.3. pac_EnableSlotInterrupt

This function performs hardware operations necessary to enable the specified hardware interrupt.

Syntax

C++

```
void pac_EnableSlotInterrupt(  
    BYTE slot,  
    BOOL bEnable  
);
```

Parameter

slot

[in] Specify the index of slot to enable interrupt or disable.

bEnable

[in] Specify the Slot interrupt turning on or not.

Return Values

None

Examples

[VC/VS]

```
int slot = 3; // if slot is 3
int CALLBACK slot_callback_proc()
{
    // do something
    pac_InterruptDone(slot);
    return true;
    // if return true, SDK will do pac_InterruptDone automatically
    //else, users should do pac_InterruptDone by themselves if needed
    // if interrupt type is level trigger, no matter return true or false,
    // needn't add pac_InterruptDone and it will work correctly.
}
void CIntrDlg::OnButton1()
{
    pac_RegisterSlotInterrupt(slot, slot_callback_proc);
    pac_EnableSlotInterrupt(slot, true);    // enable slot interrupt
}

void CIntrDlg::OnButton2()
{
    pac_EnableSlotInterrupt(slot, false);    // disable slot interrupt
    pac_UnregisterSlotInterrupt(slot);    // unregister slot interrupt
}
```

Remark

Default trigger type is level trigger.

For XP-8000 series, only support level trigger type.

3.4. pac_SetSlotInterruptPriority

This function sets the priority for a real-time thread on a thread by thread basis.

Syntax

C++

```
BOOL pac_SetSlotInterruptPriority(  
    BYTE slot,  
    int nPriority  
);
```

Parameter

slot

[in] Specify the index of slot to set priority.

nPriority

[in] Priority to set for the thread.

This value can range from 0 through 255, with 0 as the highest priority.

Return Values

TRUE indicates success.

FALSE indicates failure.

Examples

None

3.5. pac_InterruptInitialize

This function initializes a slot interrupt with the kernel. This initialization allows the slot to register an event and enable the interrupt.

Syntax

C++

```
BOOL pac_InterruptInitialize(  
    BYTE slot  
);
```

Parameter

slot

[in] Specify the index of slot to initialize.

Return Values

TRUE indicates success; FALSE indicates failure.

Examples

None

Remark

Default trigger type is level trigger.

For XP-8000 series, only support level trigger type.

If you want to get the registered event handle, please call this API, `pac_GetSlotInterruptEvent`.

3.6. pac_GetSlotInterruptEvent

This function retrieves the slot event handle which registered by pac_InterruptInitialize.

Syntax

C++

```
HANDLE pac_GetSlotInterruptEvent(  
    BYTE slot  
);
```

Parameter

slot

[in] Specify the index of slot to retrieve the event handle.

Return Values

A handle to the event object indicates success. NULL indicates failure.

Examples

None

3.7. pac_SetSlotInterruptEvent

This function allows a device driver to assign the slot event handle.

Syntax

C++

```
void pac_SetSlotInterruptEvent(  
    BYTE slot,  
    HANDLE hEvent  
);
```

Parameter

slot

[in] Specify the index of slot to retrieve the event handle.

hEvent

[in] Event to be signaled.

Return Values

None

Examples

None

3.8. pac_SetTriggerType

This function can assign the pulse trigger type for separate slot.

Syntax

C++

```
void pac_SetTriggerType(  
    BYTE slot,  
    int iType  
);
```

Parameter

iType

[in] Specify the pulse trigger type.

- 0: Rising edge trigger(default)
- 1: Level trigger
- 2: Falling edge trigger

Return Values

None

Examples

None

Remark

For XP-8000 series, only support level trigger type.

3.9. pac_GetSlotInterruptID

This function retrieves the slot interrupt ID.

Syntax

C++

```
DWORD pac_GetSlotInterruptID(  
    BYTE Slot  
);
```

Parameter

slot

[in] Specify the slot.

Return Values

Return the slot interrupt ID.

Examples

None

3.10. pac_InterruptDone

This function signals to the kernel that interrupt processing has been completed.

Syntax

C++

```
void pac_InterruptDone(  
    BYTE slot  
);
```

Parameter

slot

[in] Specify the slot to clear trigger.

Return Values

None

Examples

[VC/VS]

```
HANDLE hIntr;
BOOL bExit = false;
BYTE slot=0;

DWORD INTP_Thread(PVOID pContext)
{
    while (bExit)
    {
        WaitForSingleObject(hIntr, INFINITE);

        // do something
        pac_InterruptDone(slot);
    }
    pac_EnableSlotInterrupt(slot, false);
    pac_SetSlotInterruptEvent( slot, NULL);
    CloseHandle(pac_GetSlotInterruptEvent(slot));
    return 0;
}

void CInterruptDlg::OnButton1()
{
    bExit = true;
    pac_InterruptInitialize(slot);
    pac_EnableSlotInterrupt(slot, true);
    hIntr = pac_GetSlotInterruptEvent(slot);
    CreateThread(NULL, 0, INTP_Thread, &slot, 0, NULL);
}
```

4. Memory Access API

Memory Access Reference

Memory operations include basic management operations, such as reading from and writing to the EEPROM or SRAM. The following topics describe how you can read, or write data programmatically using the memory functions.

Supported Modules

The following shows the overview of the memory access functions which are available with XPAC.

Functions\Models	XP-8000 (WES)	XP-8000-CE6	XP-8000-Atom (WES)	XP-8000-Atom -CE6
pac_GetMemorySize	Y	Y	Y	Y
pac_ReadMemory	Y	Y	Y	Y
pac_WriteMemory	Y	Y	Y	Y
pac_EnableEEPROM	Y	Y	Y	Y

Function List

The following functions are used to retrieve or set memory access functions.

Function	Description
pac_GetMemorySize	This function retrieves the size of the specified memory.
pac_ReadMemory	This function retrieves data from the specified memory.
pac_WriteMemory	This function stores data in the specified memory.
pac_EnableEEPROM	This function turns on/off for writing EEPROM.

4.1. pac_GetMemorySize

This function retrieves the size of the specified memory.

Syntax

C++

```
DWORD pac_GetMemorySize(  
    int mem_type  
);
```

Parameter

mem_type

[in] Handle to a currently type memory.

XPAC_MEM_SRAM 0

XPAC_MEM_EEPROM 1

Return Values

The return value specifies the memory size.

Examples

[VC/VS]

```
DWORD mem_size;  
mem_size = pac_GetMemorySize(XPAC_MEM_SRAM);
```

[C#] for XP-8000 series only

```
uint mem_size;  
mem_size = XPac.pac_GetMemorySize(0);
```

4.2. pac_ReadMemory

This function retrieves data from the specified memory.

Syntax

C++

```
BOOL pac_ReadMemory(  
    DWORD address,  
    LPBYTE lpBuffer,  
    DWORD dwLength,  
    int mem_type  
);
```

Parameter

address

[in] Specifies the memory address where read from.

lpBuffer

[in] A pointer to a buffer that receives the memory data.

dwLength

[in] Number of characters to be read.

mem_type

[in] Handle to a currently type memory.

XPAC_MEM_SRAM 0

XPAC_MEM_EEPROM 1

Return Values

Return TRUE if success, otherwise false. To get an error code, call `pac_GetLastError`. A nonzero error code defined in `PACERROR.h` indicates failure. To get a generic description of the error, call `pac_GetErrorMessage`. The message resource is optional; therefore, if you call `pac_GetErrorMessage` it could fail.

Examples

[VC/VS]

```
#define LENGTH 1
BOOL ret;
DWORD address = 0;
BYTE Buffer[LENGTH] = 10;
ret = pac_ReadMemory(address, Buffer, LENGTH, XPAC_MEM_SRAM);
```

[C#] for XP-8000 series only

```
bool ret;
uint address ;
byte[] Buffer = new byte [1];
Buffer[0] = 10;
ret = XPac.pac_ReadMemory(address, Buffer, LENGTH, 0);
```

4.3. pac_WriteMemory

This function stores data in the specified memory.

Syntax

C++

```
BOOL pac_WriteMemory(  
    DWORD address,  
    LPBYTE lpBuffer,  
    DWORD dwLength,  
    int mem_type  
);
```

Parameter

Address

[in] Specifies the memory address where write from.

lpBuffer

[in] A pointer to the buffer containing the data to be written to the memory.

dwLength

[in] Number of characters to be written.

mem_type

[in] Handle to a currently type memory.

XPAC_MEM_SRAM 0

XPAC_MEM_EEPROM 1

Return Values

Return TRUE if success, otherwise false. To get an error code, call `pac_GetLastError`. A nonzero error code defined in `PACERROR.h` indicates failure. To get a generic description of the error, call `pac_GetErrorMessage`. The message resource is optional; therefore, if you call `pac_GetErrorMessage` it could fail.

Examples

[VC/VS]

```
#define LENGTH 1
BOOL ret;
DWORD address = 0;
BYTE Buffer[LENGTH] = 10;
ret = pac_WriteMemory(address, Buffer, LENGTH, XPAC_MEM_SRAM);
```

[C#] for XP-8000 series only

```
bool ret;
uint address;
byte[] Buffer = new byte [1];
Buffer[0] = 10;
ret = XPac.pac_WriteMemory(address, Buffer, LENGTH, 0);
```

Remark

Before writing EEPROM, the EEPROM should be enabled using `pac_EnableEEPROM`.

4.4. pac_EnableEEPROM

This function turns on/off for writing EEPROM.

Syntax

C++

```
void pac_EnableEEPROM(  
    BOOL bEnable  
);
```

Parameter

bEnable

[in] To turn on or protect EEPROM.

True: To turn on EEPROM

False: To protect EEPROM

Return Values

None

Examples

[VC/VS]

```
int ret;
DWORD address;
BYTE Buffer[LENGTH];
pac_EnableEEPROM)(true);
ret = pac_WriteMemory(address, Buffer, LENGTH, XPAC_MEM_EEPROM);
pac_EnableEEPROM)(false) ;
```

[C#] for XP-8000 series only

```
int ret;
uint address;
byte[] Buffer = new byte [LENGTH];
XPac.pac_EnableEEPROM)(true);
ret = XPac.pac_WriteMemory(address, Buffer, Buffer.Length, 0);
XPac.pac_EnableEEPROM)(false);
```

Remark

Before writing EEPROM, need turn on the EEPROM; after written EEPROM, need turn off the EEPROM.

5. Watchdog API

Watchdog Reference

Watchdog operations include basic management operations, such as turning on and refreshing. The following topics describe how you can operate watchdog programmatically using the watchdog functions.

Supported Modules

The following shows the overview of the interrupt functions which are available with XPAC.

Functions\Models	XP-8000 (WES)	XP-8000-CE6	XP-8000-Atom (WES)	XP-8000-Atom -CE6
pac_EnableWatchDog	Y	Y	Y	Y
pac_DisableWatchDog	Y	Y	Y	Y
pac_RefreshWatchDog	Y	Y	Y	Y
pac_GetWatchDogState	Y	Y	Y	Y
pac_GetWatchDogTime	Y	Y	Y	Y
pac_SetWatchDogTime	Y	Y	Y	Y

Function List

The following functions are used to retrieve or set interrupt functions.

Function	Description
pac_EnableWatchDog	This function turns on the watchdog operation.
pac_DisableWatchDog	This function turns off the watchdog operation.
pac_RefreshWatchDog	This function refreshes the watchdog.
pac_GetWatchDogState	This function retrieves the watchdog state.
pac_GetWatchDogTime	This function retrieves the watchdog time.
pac_SetWatchDogTime	The same as the pac_EnableWatchDog function.

5.1. pac_EnableWatchDog

This function turns on the watchdog operation.

Syntax

C++

```
BOOL pac_EnableWatchDog(  
    int wdt,  
    DWORD value  
);
```

Parameter

wdt

[in] Specifies the Watchdog type:

XPAC_WDT_HW 0

XPAC_WDT_OS 1

value

[in] Specifies the watchdog time.

Return Values

Return TRUE if success, otherwise false. To get an error code, call `pac_GetLastError`. A nonzero error code defined in `PACERROR.h` indicates failure. To get a generic description of the error, call `pac_GetErrorMessage`. The message resource is optional; therefore, if you call `pac_GetErrorMessage` it could fail.

Examples

[VC/VS]

```
DWORD second;  
BOOL ret;  
ret = pac_EnableWatchDog(XPAC_WDT_OS, second);
```

[C#] for XP-8000 series only

```
uint second;  
bool ret;  
ret = XPac.pac_EnableWatchDog(1, second);
```

Remark

The unit of the second parameter of the OS watchdog is second. In addition, the unit can not be zero.

The hardware watchdog second parameter is a value which is between 1~63 unit.

A unit is about 0.5 seconds. 1 means the shortest timeout, otherwise 63 is longest and it takes about 30 seconds.

5.2. pac_DisableWatchDog

This function turns off the watchdog operation.

Syntax

C++

```
void pac_DisableWatchDog(  
    int wdt  
);
```

Parameter

wdt

[in] Specifies the Watchdog type:

XPAC_WDT_HW 0

XPAC_WDT_OS 1

Return Values

None

Examples

[VC/VS]

```
pac_DisableWatchDog(XPAC_WDT_OS);
```

[C#] for XP-8000 series only

```
XPac.pac_DisableWatchDog(1);
```

5.3. pac_RefreshWatchDog

This function refreshes the watchdog.

Syntax

C++

```
void pac_RefreshWatchDog(  
    int wdt  
);
```

Parameter

wdt

[in] Specifies the Watchdog type:

XPAC_WDT_HW 0

XPAC_WDT_OS 1

Return Values

None

Examples

[VC/VS]

```
pac_RefreshWatchDog(XPAC_WDT_OS);
```

[C#] for XP-8000 series only

```
XPac.pac_RefreshWatchDog(1);
```

5.4. pac_GetWatchDogState

This function retrieves the watchdog state.

Syntax

C++

```
BOOL pac_GetWatchDogState(  
    int wdt  
);
```

Parameter

wdt

[in] Specifies the Watchdog type:

XPAC_WDT_HW 0

XPAC_WDT_OS 1

Return Values

The return value specifies the watchdog state.

If turning on, return TRUE, otherwise FALSE.

Examples

[VC/VS]

```
BOOL bState;  
bState = pac_GetWatchDogState(XPAC_WDT_OS);
```

[C#] for XP-8000 series only

```
bool bState;  
bState = XPac.pac_GetWatchDogState(1);
```

5.5. pac_GetWatchDogTime

This function retrieves the watchdog time.

Syntax

C++

```
DWORD pac_GetWatchDogTime(  
    int wdt  
);
```

Parameter

wdt

[in] Specifies the Watchdog type:

XPAC_WDT_HW 0

XPAC_WDT_OS 1

Return Values

The return value is the watchdog time which has been assigned by `pac_EnableWatchDog` or `pac_SetWatchDogTime`.

The unit of return value is second for OS watchdog value which is between 0~63 for hardware watchdog.

Examples

[VC/VS]

```
DWORD dwTime;  
dwTime = pac_GetWatchDogTime(XPAC_WDT_OS);
```

[C#] for XP-8000 series only

```
uint uTime;  
uTime = XPac.pac_GetWatchDogTime(1);
```

5.6. pac_SetWatchDogTime

The same as the pac_EnableWatchDog function.

The hardware watchdog second Parameter is a value which is between 0~63 unit.

A unit is about 0.5 seconds. 0 means the shortest timeout, otherwise 63 is longest which is about 30 seconds.

Syntax

C++

```
bool pac_SetWatchDogTime(  
    int wdt,  
    DWORD value  
);
```

Parameter

wdt

[in] Specifies the Watchdog type:

XPAC_WDT_HW

XPAC_WDT_OS

value

[in] Specifies the watchdog time.

Return Values

None

Examples

[VC/VS]

```
DWORD dwTime;  
pac_SetWatchDogTime(XPAC_WDT_OS, dwTime);
```

[C#] for XP-8000 series only

```
uint uTime;  
XPac.pac_SetWatchDogTime(1, uTime);
```

Remark

The same as the `pac_EnableWatchDog` function.

The unit of the second parameter of the OS watchdog is second. In addition, the unit can not be zero.

The hardware watchdog second Parameter is a value which is between 0~63 unit.

A unit is about 0.5 seconds. 0 means the shortest timeout, otherwise 63 is longest which is about 30 seconds.

6. Uart API

Uart Reference

Uart operations include basic management operations, such as opening, sending, receiving, and closing. The following topics describe how you can operate uart programmatically using the uart functions.

Remark

We provide several COM port functions (uart_Send/uart_Recv...) to communicate with ICPDAS modules (High profile I-87K series, I-811xW/I-814xW series, I-7000 series). All the functions are based on standard COM port API functions in C++ (CreateFile/CloseHandle/WriteFile/ReadFile /GetCommModemStatus.....).

Use these functions of this section to communicate with I-87K

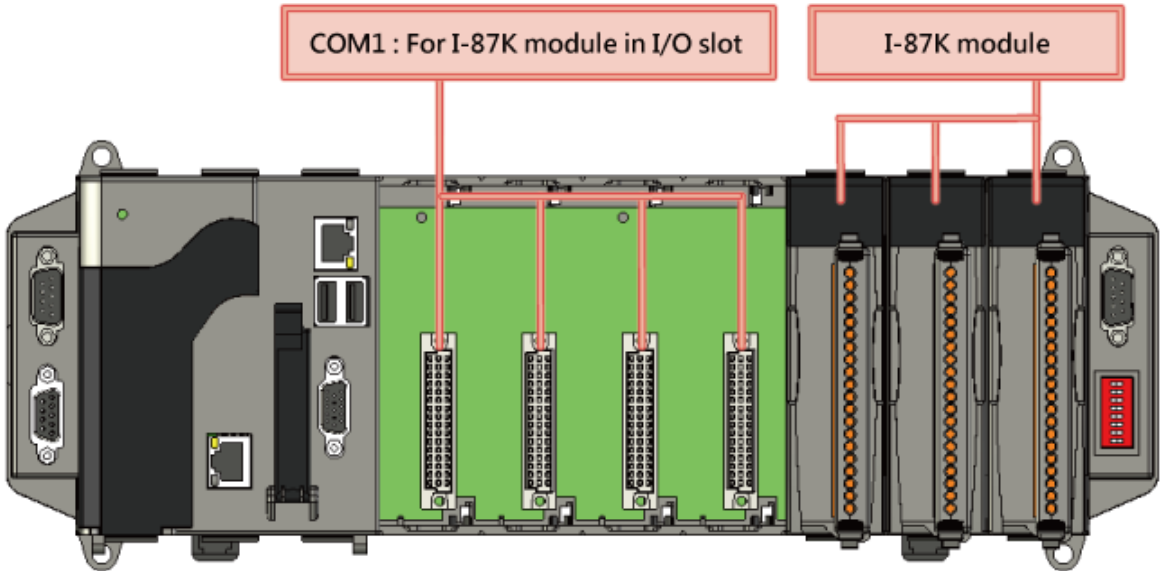

When a high profile I-87K is plugged in slot, please call the function, `pac_ChangeSlot`, to change to the specific slot before doing other operations. Please refer to demo “87k_Basic”.

About I-87K commands (DCON protocol), please refer http://ftp.icpdas.com/pub/cd/8000cd/napdos/dcon/io_module/87k_high_profile_modules.htm

Although user can use UART API to set and read values for high profile I-87K series modules, we provide a more convenient API to do it. Please refer Section 7 PAC_IO API

Use these functions of this section to communicate with external devices by I-811xW/I-814xW series modules.

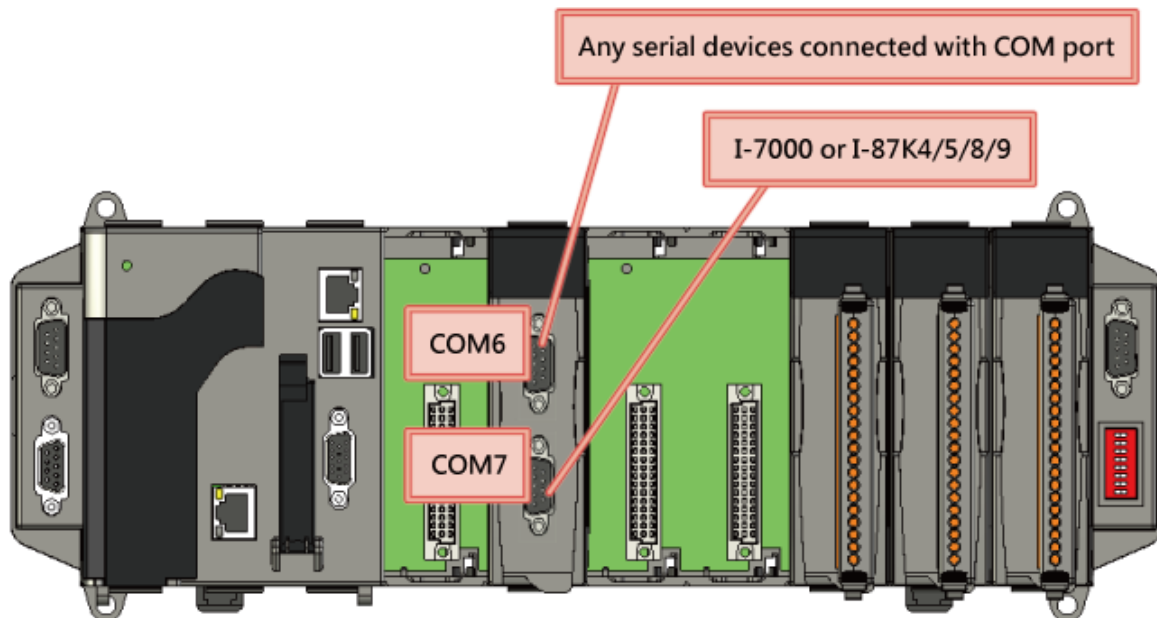

Supported Modules

The following shows the overview of the system functions which are available with XPAC.

Functions\Models	XP-8000 (WES)	XP-8000-CE6	XP-8000-Atom (WES)	XP-8000-Atom -CE6
uart_Open	Y	Y	Y	Y
uart_Close	Y	Y	Y	Y
uart_Send	Y	Y	Y	Y
uart_Recv	Y	Y	Y	Y
uart_SendCmd	Y	Y	Y	Y
uart_SetTimeOut	Y	Y	Y	Y
uart_EnableCheckSum	Y	Y	Y	Y
uart_SetTerminator	Y	Y	Y	Y
Uart_BinSend	Y	Y	Y	Y
Uart_BinRecv	Y	Y	Y	Y
Uart_BinSendCmd	Y	Y	Y	Y
Uart_GetLineStatus	Y	Y	Y	Y
Uart_GetDataSize	Y	Y	Y	Y

Function List

The following functions are used to retrieve or set system information.

Function	Description
uart_Open	This function opens the COM port and specifies the baud rate, parity bits, data bits, and stop bits.
uart_Close	This function closes the COM port which has been opened.
uart_Send	This function sends data through the COM port which have been opened.
uart_Recv	This function retrieves data through the COM port which have been opened.
uart_SendCmd	This function sends commands through the COM port which have been opened.
uart_SetTimeOut	This function sets the time out timer.
uart_EnableCheckSum	This function turns on the check sum or not.
uart_SetTerminator	This function sets the terminate characters.
Uart_BinSend	this function can send out command string with or without null character under the consideration of the command length.
Uart_BinRecv	This function is applied to receive the fix length response.
Uart_BinSendCmd	This function is used to Send binary command and receive binary data with the fixed length.
Uart_GetLineStatus	This function retrieves the modem control-register values.
Uart_GetDataSize	This function retrieves the number of bytes received by the serial provider but not yet read by a uart_Recv operation, or of user data remaining to transmitted for write operations.

6.1. uart_Open

This function opens the COM port and specifies the baud rate, parity bits, data bits, and stop bits.

Syntax

C++

```
HANDLE uart_Open(  
    LPCSTR ConnectionString  
);
```

Parameter

connectionString

[in] Specifies the COM port, baud rate, parity bits, data bits, and stop bits.

The default setting is COM1, 115200, N, 8, 1.

The format of ConnectionString is as follows:

“com_port, baud_rate, parity_bits, data_bits, stop_bits”

Warning: there is no blank space between each parameter.

Com_port:

COM1, COM2.....

baud_rate:

1200/2400/4800/9600/19200/38400/57600/115200

parity_bits:

'N' = NOPARITY

'O' = ODDPARITY

'E' = EVENPARITY

'M' = MARKPARITY

'S' = SPACEPARITY

Data_bits:

5/6/7/8

Stop_bits:

"1" = ONESTOPBIT

"2" = TWOSTOPBITS

"1.5" = ONE5STOPBITS

Return Values

A handle to the open COM port.

Nonzero indicates success.

If the function fails, the return value is INVALID_HANDLE_VALUE.

(INVALID_HANDLE_VALUE should be 0xffffffff in C/C++/MFC.

INVALID_HANDLE_VALUE should be -1 in .NET.)

To get extended error information, call GetLastError. To get a generic description of the error, call pac_GetErrorMessage. The message resource is optional; therefore, if you call pac_GetErrorMessage it could fail.

Examples

[VC/VS]

```
HANDLE hOpen;  
hOpen = uart_Open("COM1,9600,N,8,1");
```

[C#] for XP-8000 series only

```
IntPtr hOpen;  
hOpen = XPac.uart_Open("COM1,9600,N,8,1");  
Remark  
The uart_Open function does not open the specified COM port if the COM port has  
been opened.
```

6.2. uart_Close

This function closes the COM port which has been opened.

Syntax

C++

```
BOOL uart_Close(  
    HANDLE hPort  
);
```

Parameter

hPort

[in] Handle to the open COM port to close.

Return Values

TRUE indicates success. FALSE indicates failure.

Examples

[VC/VS]

```
BOOL ret;  
HANDLE hOpen;  
hOpen = uart_Open("COM1,9600,N,8,1");  
ret = uart_Close(hOpen);
```

[C#] for XP-8000 series only

```
bool ret;  
IntPtr hOpen;  
hOpen = XPac.uart_Open("COM1,9600,N,8,1");  
ret = XPac.uart_Close(hOpen);
```

Remark

The function for a specified COM port should not be used after it has been closed.

6.3. uart_Send

This function sends data through the COM port which have been opened.

This function will send a string. If the checksum is enabled by the `uart_EnableCheckSum` function, this function automatically adds the two checksum bytes to the string. And then the end of sending string is further added [0x0D] to mean the termination of the string (`buf`).

Syntax

C++

```
BOOL uart_Send(  
    HANDLE hPort,  
    LPCSTR buf  
);
```

Parameter

hPort

[in] Handle to the open COM port.

buf

[in] A pointer to a buffer that send the data. 2048 bytes maximum.

Return Values

TRUE indicates success. FALSE indicates failure.

Examples

[VC/VS]

```
BOOL ret;  
HANDLE hOpen;  
char buf[Length];  
hOpen = uart_Open("COM1,9600,N,8,1");  
ret = uart_Send(hOpen, buf);
```

[C#] for XP-8000 series only

```
bool ret;  
IntPtr hOpen;  
string buf;  
hOpen = XPac.uart_Open("COM1,9600,N,8,1");  
ret = XPac.uart_Send(XPac.AnsiString(buf));
```

Remark

A string for "buf" cannot include space character within the string. Otherwise, the string will be stopped by space character. For example: "\$01M 02 03" of the user defined string. However, the actual string sent out is "\$01M"+0x0D.

The terminate characters is 0x0D. (Refer to `uart_SetTerminator` function to change.)

This function will call `PurgeComm()` to clear serial COM port output buffer.

This function sends data with a terminate character 0x0D. For example:

Check sum is disabled. The "buf" are five bytes (ABCD+0x0). This function will send five bytes (ABCD+0x0D).

6.4. uart_Recv

This function retrieves data through the COM port which have been opened.

This function will receive a string+0x0D. Wait a character [0x0D] to mean the termination of a string. And then if the checksum is enabled by the `uart_EnableCheckSum` function, this function automatically check the two checksum bytes to the string. This function will provide a string without the last byte [0x0D].

Syntax

C++

```
BOOL uart_Recv(  
    HANDLE hPort,  
    LPSTR buf  
);
```

Parameter

hPort

[in] Handle to the open COM port.

buf

[out] A pointer to a buffer that receives the data.

Return Values

TRUE indicates success. FALSE indicates failure.

If this function doesn't receive a character 0x0D, the other data still store to "buf" but the return value is 0. Calling `GetLastError` function will get an error code (PAC_ERR_UART_READ_TIMEOUT)

Examples

[VC/VS]

```
BOOL ret;  
HANDLE hOpen;  
char buf[Length];  
hOpen = uart_Open("COM1,9600,N,8,1");  
ret = uart_Recv(hOpen, buf);
```

[C#] for XP-8000 series only

```
bool ret;  
IntPtr hOpen;  
string buf;  
hOpen = XPac.uart_Open("COM1,9600,N,8,1");  
ret = XPac.uart_Recv(XPac.AnsiString(buf));
```

Remark

The terminate characters is 0x0D. (Refer to `uart_SetTerminator` function to change.)

For example:

- a. Check sum is disabled. This function receives five bytes (ABCD+0x0D). The “buf” will be five bytes (ABCD+0x0).
- b. Check sum is disabled. This function receives four bytes (ABCD). The “buf” will be four bytes (ABCD). But the return value is 0.

6.5. uart_SendCmd

This function sends commands through the COM port which have been opened.

This function is a combination of `uart_Send` and `uart_Recv`.

The operation for sending a command is the same as `uart_Send`.

The operation for receiving a response is the same as `uart_Recv`.

Syntax

C++

```
BOOL uart_SendCmd(  
    HANDLE hPort,  
    LPCSTR cmd,  
    LPSTR szResult  
);
```

Parameter

hPort

[in] Handle to the open COM.

cmd

[in] A pointer to a command.

szResult

[out] A pointer to a buffer that receives the data.

Return Values

TRUE indicates success. FALSE indicates failure.

Examples

[VC/VS]

```
BOOL ret;  
HANDLE hOpen;  
char buf[Length];  
hOpen = uart_Open("COM1,9600,N,8,1");  
ret = uart_SendCmd(hOpen,"$00M", buf); // $00M: ask the device name  
uart_Close(hPort);
```

[C#] for XP-8000 series only

```
bool ret;  
IntPtr hOpen;  
string buf;  
hOpen = XPac.uart_Open("COM1,9600,N,8,1");  
ret = XPac.uart_SendCmd(hOpen, XPac.AnsiString("$00M"), buf);  
// $00M: ask the device name  
XPac.uart_Close(hPort);
```

Remark

This function will call PurgeComm() to clear serial COM port output and input buffer.

6.6. uart_SetTimeOut

This function sets the time out timer.

Syntax

C++

```
void uart_SetTimeOut(  
    HANDLE hPort,  
    DWORD msec,  
    int ctoType  
);
```

Parameter

hPort

[in] Handle to the open COM port.

msec

[in] Millisecond to the timer.

ctoType

[in] Specifies the time out timer type as following:

CTO_TIMEOUT_ALL 0

CTO_READ_RETRY_TIMEOUT 1

CTO_READ_TOTAL_TIMEOUT 2

CTO_WRITE_TOTAL_TIMEOUT 3

Return Values

None

Examples

[VC/VS]

```
HANDLE hOpen;
DWORD mes;
hOpen = uart_Open("COM1,9600,N,8,1");
mes = 300;
uart_SetTimeOut(hOpen, mes, CTO_TIMEOUT_ALL);
uart_Close(hOpen);
```

[C#] for XP-8000 series only

```
IntPtr hOpen;
uint msc;
hOpen = XPac.uart_Open("COM1,9600,N,8,1");
mes = 300;
XPac.uart_SetTimeOut(hOpen, msc, 0);
XPac.uart_Close(hOpen);
```

Remark

CTO_READ_TOTAL_TIMEOUT:

A constant used to calculate the total time-out period for read operations, in milliseconds.

A value of zero for the CTO_READ_TOTAL_TIMEOUT indicates that total time-outs are not used for read operations.

CTO_WRITE_TOTAL_TIMEOUT:

A constant used to calculate the total time-out period for write operations, in milliseconds.

A value of zero for the CTO_WRITE_TOTAL_TIMEOUT indicates that total time-outs are not used for write operations.

CTO_READ_RETRY_TIMEOUT:

A constant used to calculate the time-out period for read operations, in system tick count.

CTO_TIMEOUT_ALL:

A constant used to calculate the total time-out period for write and read operations, in milliseconds.

A value of zero for the CTO_TIMEOUT_ALL indicates that total time-outs are not used for write and read operations.

6.7. uart_EnableChecksum

This function turns on the check sum or not.

Add two checksum bytes to the end of data which is used to produce checksum.

Syntax

C++

```
void uart_EnableChecksum(  
    HANDLE hPort,  
    BOOL bEnable  
);
```

Parameter

hPort

[in] Handle to the open COM port.

bEnable

[in] Decide the check sum turning on or not.

Default is disabling.

Return Values

None

Examples

[VC/VS]

```
HANDLE hUart;  
char result[32];  
hUart = uart_Open("");  
uart_EnableCheckSum(hUart , true);  
pac_ChangeSlot(1);  
uart_SendCmd(hUart, "$00M", result);
```

[C#] for XP-8000 series only

```
byte[] result = new byte[32];  
IntPtr hPort = XPac.uart_Open("");  
XPac.uart_EnableCheckSum(hPort, true);  
XPac.pac_ChangeSlot(1);  
XPac.uart_SendCmd(hPort, XPac.AnsiString("$00M"), result);  
string str = XPac.WideString(result);
```

6.8. uart_SetTerminator

This function sets the terminate characters.

Syntax

C++

```
void uart_SetTerminator(  
    HANDLE hPort,  
    LPCSTR szTerm  
);
```

Parameter

hPort

[in] Handle to the open COM port.

szTerm

[in] Pointer the terminate characters.

Default is CR.

Return Values

None

Examples

[VC/VS]

```
HANDLE hUart;  
char result[32];  
hUart = uart_Open("");  
uart_SetTerminator(hUart, "\\015");  
pac_ChangeSlot(1);  
uart_SendCmd(hUart, "$00M", result);
```

[C#] for XP-8000 series only

```
byte[] result = new byte[32];  
IntPtr hPort = XPac.uart_Open("");  
XPac.uart_SetTerminator(hPort, XPac.AnsiString("\\015"));  
XPac.pac_ChangeSlot(1);  
XPac.uart_SendCmd(hPort, XPac.AnsiString("$00M"), result);  
string str = XPac.WideString(result);
```

Remark

This function relates to `uart_Send/uart_Recv/uart_SendCmd`.

6.9. Uart_BinSend

Send out the command string by fix length, which is controlled by the Parameter "in_Len". The difference between this function and `uart_Send` is that `uart_BinSend` terminates the sending process by the string length "in_Len" instead of the character "CR"(Carry return). Therefore, this function can send out command string with or without null character under the consideration of the command length. Besides, because of this function without any error checking mechanism (Checksum, CRC, LRC... etc.), users have to add the error checking information to the raw data by themselves if communication checking system is required.

Syntax

C++

```
bool uart_BinSend(  
    HANDLE hPort,  
    LPCSTR buf,  
    DWORD in_Len  
);
```

Parameter

hPort

[in] Handle to the open COM port.

buf

[in] A pointer to a buffer that send the data.

in_Len

[in] The length of result string.

Return Values

1 indicates success. 0 indicates failure.

Examples

[VC/VS]

```
bool ret;
HANDLE hPort;
char buf[2];
buf[0] = 0x41;
buf[1] = 0x42;
hPort = uart_Open("COM4,9600,N,8,1");
ret = uart_BinSend(hPort, buf, 2);
uart_Close(hPort);
```

[C#]

```
bool ret;
IntPtr hPort;
string buf = "AB";
hPort = XPac.uart_Open("COM4,9600,N,8,1");
ret = XPac.uart_BinSend(hPort, XPac.AnsiString(buf), 2);
XPac.uart_Close(hPort);
```

Remark

Note that this function is usually applied to communicate with the other device, but not for ICPDAS DCON (I-7000/8000/87K) series modules.

This function will call PurgeComm() to clear serial COM port output buffer.

6.10. Uart_BinRecv

This function is applied to receive the fix length response. The length of the receiving response is controlled by the Parameter "in_Len". The difference between this function and `uart_Recv` is that `uart_BinRecv` terminates the receiving process by the string length "in_Len" instead of the character "CR"(Carry return). Therefore, this function can be used to receive the response string data with or without null character under the consideration of receiving length. Besides, because of this function without any error checking mechanism (checksum, CRC, LRC... etc.), users have to remove the error checking information from the raw data by themselves if communication checking system is used.

Syntax

C++

```
bool uart_BinRecv(  
    HANDLE hPort,  
    LPSTR buf,  
    DWORD in_Len  
);
```

Parameter

hPort

[in] Handle to the open COM port.

buf

[out] A pointer to a buffer that receives the data.

in_Len

[in] The length of result string.

Return Values

1 indicates success. 0 indicates failure.

Examples

[VC/VS]

```
bool ret;
HANDLE hPort;
char buf[2];
hPort = uart_Open("COM4,9600,N,8,1");
ret = uart_BinSend(hPort, "AB", 2);
ret = uart_BinRecv(hPort, buf, 2);
uart_Close(hPort);
```

[C#]

```
bool ret;
IntPtr hPort;
byte[] buf = new byte[100];
hPort = XPac.uart_Open("COM4,9600,N,8,1");
ret = XPac.uart_BinSend(hPort, XPac.AnsiString("AB"), 2);
ret = XPac.uart_Recv(hPort, buf);
XPac.uart_Close(hPort);
```

Remark

Note that this function is usually applied to communicate with the other device, but not for ICPDAS DCON (I-7000/8000/87K) series modules.

6.11. Uart_BinSendCmd

This function is used to Send binary command and receive binary data with the fixed length.

This function is a combination of `uart_BinSend` and `uart_BinRecv`.

The operation for sending a command is the same as `uart_BinSend`.

The operation for receiving a response is the same as `uart_BinRecv`.

Syntax

C++

```
bool uart_BinSendCmd(  
    HANDLE hPort,  
    LPCSTR ByteCmd,  
    DWORD in_Len,  
    LPSTR ByteResult,  
    DWORD out_Len  
);
```

Parameter

hPort

[in] Handle to the open COM.

ByteCmd

[in] A pointer to a command.

in_Len

[in] The length of command string.

ByteResult

[out] A pointer to a buffer that receives the data.

out_Len

[in] The length of result string.

Return Values

1 indicates success. 0 indicates failure.

Examples

[VC/VS]

```
bool ret;
HANDLE hPort;
char buf[2];
char cmd[2];
hPort = uart_Open("COM4,9600,N,8,1");
cmd[0] = 0x41;
cmd[1] = 0x42;
ret = uart_BinSendCmd( hPort, cmd, 2, buf, 2);
uart_Close(hPort);
```

[C#]

```
bool ret;
byte[] cmd = new byte[2];
IntPtr hPort;
byte[] buf = new byte[2];
cmd[0] = 0x41;
cmd[1] = 0x42;
hPort = XPac.uart_Open("COM4,9600,N,8,1");
ret = XPac.uart_BinSendCmd(hPort, cmd, 2, buf, 2);
XPac.uart_Close(hPort);
```

Remark

This function will call PurgeComm() to clear serial COM port output and input buffer.

6.12. Uart_GetLineStatus

This function retrieves the modem control-register values.

Syntax

C++

```
BOOL uart_GetLineStatus(  
    HANDLE hPort,  
    int pin  
);
```

Parameter

hPort

[in] Handle to the open COM port.

pin

[in] A variable specifies state of a pin of the COM port.

This parameter can be following values:

```
#define CTS 0  
#define DSR 1  
#define RI 2  
#define CD 3
```

Return Values

TRUE indicates the pin's state is ON. 0 indicates OFF.

Examples

[VC/VS]

```
HANDLE hPort = uart_Open("COM5,115200,N,8,1");
BOOL ret = uart_GetLineStatus(hPort, DSR); //the pin, DSR, for example
if(ret)
printf("The status of DSR is ON\n");
else
printf("The status of DSR is OFF\n");
uart_Close(hPort);
```

[C#]

```
IntPtr hPort = XPac.uart_Open("COM5,115200,N,8,1");
//the pin, DSR, for example
bool ret = XPac.uart_GetLineStatus(hPort, DSR);
if(ret)
Console.WriteLine("The status of DSR is ON");
else
Console.WriteLine ("The status of DSR is OFF");
XPac.uart_Close(hPort);
```

6.13. Uart_GetDataSize

This function retrieves the number of bytes received by the serial provider but not yet read by a `uart_Recv` operation, or of user data remaining to transmitted for write operations.

Syntax

C++

```
BOOL uart_GetDataSize(  
    HANDLE hPort,  
    int data_type  
);
```

Parameter

hPort

[in] Handle to the open COM port.

data_type

[in] A value specifies to retrieve in or out buffer.

This parameter can be following values:

```
#define IN_DATA 0
```

```
#define OUT_DATA 1
```

Return Values

The number of bytes in/out buffer but not yet read/write.

Examples

[VC/VS]

```
char buf[1024];
DWORD in_Len;
HANDLE hPort = uart_Open("COM3,9600,N,8,1");
in_Len = uart_GetDataSize(hPort, IN_DATA);
BOOL ret = uart_BinRecv( hPort, buf, in_Len);
uart_Close(hPort);
```

[C#]

```
string buf;
uint in_Len;
IntPtr hPort = XPac.uart_Open("COM3,9600,N,8,1");
in_Len = XPac.uart_GetDataSize(hPort, 0); // 0: IN_DATA; 1: OUT_DATA
bool ret = XPac.uart_BinRecv( hPort, XPac.AnsiString(buf), in_Len);
XPac.uart_Close(hPort);
```

7. PAC_IO API

PAC_IO Reference

PAC_IO API supports to operate IO modules, which can be divided into the following parts:

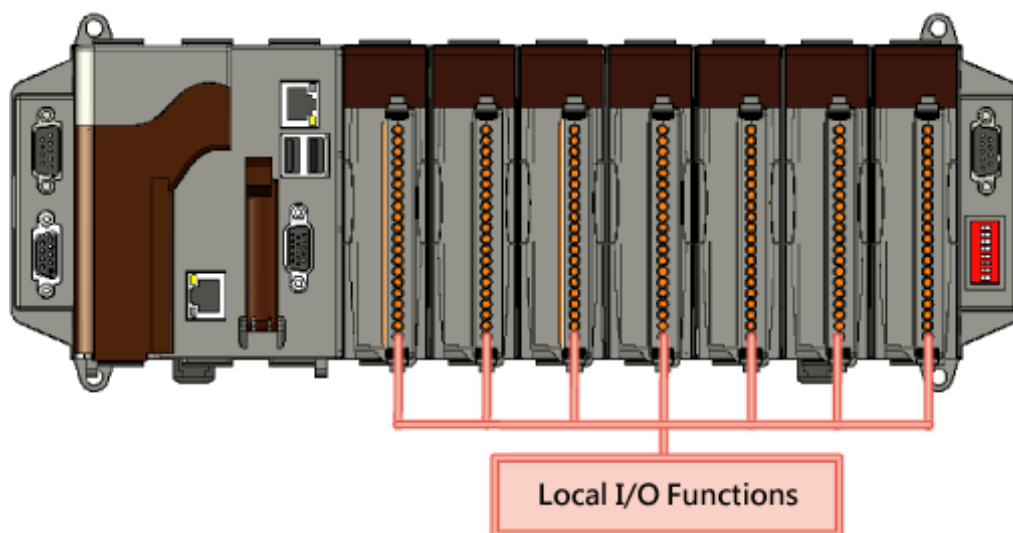

Local (IO in slot)

In the local mode, the slot range is from 0 to 7, the same the iSlot as follow.

```
hPort = uart_Open("");  
//Clear DO  
pac_WriteDO( hPort, iSlot, iDo_TotalCh, 0);
```

Remote

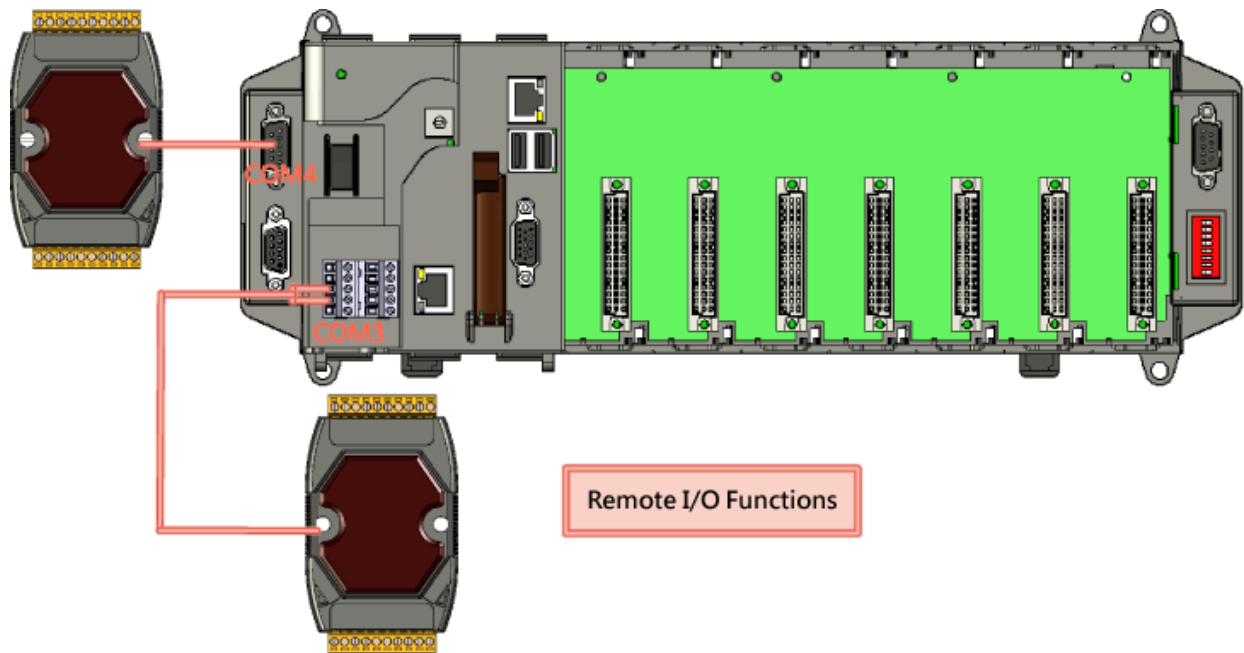

If remote mode, the address need call a macro, PAC_REMOTE_IO. And its range is from 0 to 255. For example as follow:

```
//Write D0 value to remote module  
HANDLE hPort = uart_Open(ConnectionString);  
if( !hPort ) AfxMessageBox( _T("Open Com Error"));  
  
pac_WriteD0( hPort, PAC_REMOTE_IO(iAddr), m_iDOCHs, lDO_Value);
```

Supported Modules

The following shows the overview of the PAC_IO functions which are available with XPAC.

Functions\Models	XP-8000 (WES)	XP-8000-CE6	XP-8000-Atom (WES)	XP-8000-Atom -CE6
pac_GetBit	Y	Y	Y	Y
pac_WriteDO	Y	Y	Y	Y
pac_WriteDOBit	Y	Y	Y	Y
pac_ReadDO	Y	Y	Y	Y
pac_ReadDI	Y	Y	Y	Y
pac_ReadDIO	Y	Y	Y	Y
pac_ReadDILatch	Y	Y	Y	Y
pac_ClearDILatch	Y	Y	Y	Y
pac_ReadDIOLatch	Y	Y	Y	Y
pac_ClearDIOLatch	Y	Y	Y	Y
pac_ReadDICNT	Y	Y	Y	Y
pac_ClearDICNT	Y	Y	Y	Y
pac_WriteAO	Y	Y	Y	Y
pac_ReadAO	Y	Y	Y	Y
pac_ReadAI	Y	Y	Y	Y
pac_ReadAIHex	Y	Y	Y	Y
pac_ReadAIAll	Y	Y	Y	Y
pac_ReadAIAllHex	Y	Y	Y	Y
pac_ReadCNT	Y	Y	Y	Y
pac_ClearCNT	Y	Y	Y	Y
pac_ReadCNTOverflow	Y	Y	Y	Y

Function List

The following functions are used to retrieve or set PAC_IO information.

Function	Description
pac_GetBit	The function can retrieve the value which in specific bit.
pac_WriteDO	This function writes the DO values to DO modules.
pac_WriteDOBit	This function writes a single bit of value to the DO module, that is, only the channel corresponding to the bit is changed.
pac_ReadDO	This function reads the DO value of the DO module.
pac_ReadDI	This function reads the DI value of the DI module.
pac_ReadDIO	This function reads the DI and the DO values of the DIO module.
pac_ReadDILatch	This function reads the DI latch value of the DI module.
pac_ClearDILatch	This function clears the latch value of the DI module.
pac_ReadDIOLatch	This function reads the latch values of the DI and DO channels of the DIO module.
pac_ClearDIOLatch	This function clears the latch values of DI and DO channels of the DIO module.
pac_ReadDICNT	This function reads the counts of the DI channels of the DI module.
pac_ClearDICNT	This function clears the counter value of the DI channel of the DI module.
pac_WriteAO	This function writes the AO value to the AO modules.
pac_ReadAO	This function reads the AO value of the AO module.
pac_ReadAI	This function reads the engineering-mode AI value of the AI module.
pac_ReadAIHex	This function reads the 2's complement-mode AI value of the AI module.
pac_ReadAIAll	This function reads all the AI values of all channels in engineering-mode of the AI module.
pac_ReadAIAllHex	This function reads all the AI values of all channels in 2's complement-mode of the AI module.
pac_ReadCNT	This function reads the counter values of the counter/frequency modules.

pac_ClearCNT	This function clears the counter values of the counter/frequency modules.
pac_ReadCNTOverflow	This function clears the counter overflow value of the counter/frequency modules.

7.1. pac_GetBit

The function can retrieve the value which in specific bit.

Syntax

C++

```
BOOL pac_GetBit(  
    int v,  
    int ndx  
);
```

Parameter

v

Which IO result wants to get bit.

ndx

Specific bit to retrieve.

Return Values

The value of specific index.

Examples

[VC/VS]

```
BYTE bit3;
BYTE iSlot = 2;
int iDI_TotalCh = 8;
DWORD IDI_Value;
HANDLE hPort;
hPort = uart_Open("");
BOOL iRet = pac_ReadDI(hPort, iSlot, iDI_TotalCh, &IDI_Value);
bit3 = pac_GetBit(IDI_Value, 3);
uart_Close(hPort);
```

[C#] for XP-8000 series only

```
bool bit;
int index = 3;
byte iSlot = 2;
byte iSlot = 2;
int iDI_TotalCh = 8;
uint IDI_Value = 0;
IntPtr hPort;
hPort = XPac.uart_Open("");
bool iRet = XPac.pac_ReadDI(hPort, iSlot, iDI_TotalCh, ref IDI_Value);
bit = XPac.pac_GetBit(iDI_TotalCh, index);
XPac.uart_Close(hPort);
```

Remark

The function is used the same as v & (1<<index)

If you use XPacNet.dll to develop, the return value is on or off for the specifics bit.

7.2. pac_WriteDO

This function writes the DO values to DO modules.

Syntax

C++

```
BOOL pac_WriteDO(  
    HANDLE hPort,  
    int slot,  
    int iDO_TotalCh,  
    DWORD IDO_Value  
);
```

Parameter

hPort

[in] The serial port HANDLE opened by `uart_Open()`, if the module is 87k modules in local.

0, if the module is 8k modules in local.

iSlot

[in] The slot in which module is to receive the command. Default is local.

If the IO module is remote, please use the macro, `PAC_REMOTE_IO(0...255)`.

iDO_TotalCh

[in] The total number of DO channels of the DO modules.

iDO_Value

[in] A 8-digit hexadecimal value, where bit 0 corresponds to DO0, bit 31 corresponds to DO31, etc. When the bit is 1, it denotes that the digital output channel is on, and 0 denotes that the digital output channel is off.

Return Values

TRUE indicates success. FALSE indicates failure.

Examples

[VC/VS]

Example 1:

```
// If the module is remote
```

```
HANDLE hPort;  
hPort = uart_Open("COM1,9600,N,8,1");  
int total_channel = 8;  
DWORD do_value = 4; // turn on the channel two  
BOOL ret = pac_WriteDO(hPort, PAC_REMOTE_IO(1) , total_channel , do_value );  
uart_Close(hPort);
```

Example 2:

```
// If the module is 87k local
```

```
HANDLE hPort;  
hPort = uart_Open("COM1,115200,N,8,1");  
int total_channel = 8;  
DWORD do_value = 4; // turn on the channel two  
BOOL ret = pac_WriteDO(hPort, 1 , total_channel , do_value );  
uart_Close(hPort);
```

Example 3:

```
// If the module is 8k remote
```

```
int total_channel = 8;  
DWORD do_value = 4; // turn on the channel two  
BOOL ret = pac_WriteDO(0, 1 , total_channel , do_value );
```

[C#] for XP-8000 series only

Example 1:

```
// If the module is remote
IntPtr hPort; hPort = XPac.uart_Open("COM1,9600,N,8,1");
int total_channel = 8;
uint do_value = 4; // turn on the channel two
bool ret = XPac.pac_WriteDO(hPort, XPac.PAC_REMOTE_IO(1) , total_channel ,
do_value );
XPac.uart_Close(hPort);
```

Example 2:

```
// If the module is 87k local
IntPtr hPort; hPort = XPac.uart_Open("COM1,115200,N,8,1");
int total_channel = 8;
uint do_value = 4; // turn on the channel two
bool ret = XPac.pac_WriteDO(hPort, 1 , total_channel , do_value );
XPac.uart_Close(hPort);
```

Example 3:

```
// If the module is 8k local
int total_channel = 8;
uint do_value = 4; // turn on the channel two
bool ret = XPac.pac_WriteDO(0, 1 , total_channel , do_value );
```

Remark

The function can support for Local or Remote. When the module is local, the second Parameter's range is from 0 to 7. If remote, the second Parameter need use the macro, PAC_REMOTE_IO(0...255), which range is from 0 to 255.

7.3. pac_WriteDOBit

This function writes a single bit of value to the DO module, that is, only the channel corresponding to the bit is changed.

Syntax

C++

```
BOOL pac_WriteDOBit(  
    HANDLE hPort,  
    int slot,  
    int iDO_TotalCh,  
    int iChannel,  
    int iBitValue  
);
```

Parameter

hPort

[in] The serial port HANDLE opened by `uart_Open()`, if the module is 87k modules in local.

0, if the module is 8k modules in local.

iSlot

[in] The slot in which module is to receive the command. Default is local.

If the IO module is remote, please use the macro, `PAC_REMOTE_IO(0...255)`.

iChannel

[in]The DO channel to be change.

iDO_TotalCh

[in] The total number of DO channels of the DO modules.

iBitValue

[in] 1 is to turn on the DO channel; 0 is off.

Return Values

TRUE indicates success. FALSE indicates failure.

Examples

[VC/VS]

Example 1:

// If the module is 87k local

```
HANDLE hPort;  
hPort = uart_Open("COM1,115200,N,8,1");  
BYTE iSlot = 1;  
int iChannel = 2;  
int iDO_TotalCh = 8;  
int iBitValue = 1;  
BOOL ret = pac_WriteDOBit(hPort, iSlot , iChannel , iDO_TotalCh , iBitValue );  
uart_Close(hPort);
```

Example 2:

// If the module is 8k local

```
BYTE iSlot = 1;  
int iChannel = 2;  
int iDO_TotalCh = 8;  
int iBitValue = 1;  
BOOL ret = pac_WriteDOBit(0, iSlot , iChannel , iDO_TotalCh , iBitValue );
```

[C#] for XP-8000 series only

```
// If the module is 87k local
IntPtr hPort;
hPort = XPac.udp_Open("COM1,115200,N,8,1");
byte iSlot = 1;
int iChannel = 2;
int iDO_TotalCh = 8;
int iBitValue = 1;
bool ret = XPac.pac_WriteDOBit(hPort, iSlot, iChannel, iDO_TotalCh,
iBitValue);
XPac.udp_Close(hPort);
```

Remark

The function can support for Local or Remote. When the module is local, the second Parameter's range is from 0 to 7. If remote, the second Parameter need use the macro, PAC_REMOTE_IO(0...255), which range is from 0 to 255.

7.4. pac_ReadDO

This function reads the DO value of the DO module.

Syntax

C++

```
BOOL pac_ReadDO(  
    HANDLE hPort,  
    int slot,  
    int iDO_TotalCh,  
    DWORD *IDO_Value  
);
```

Parameter

hPort

[in] The serial port HANDLE opened by `uart_Open()`, if the module is 87k modules in local.

0, if the module is 8k modules in local.

iSlot

[in] The slot in which module is to receive the command. Default is local.

If the IO module is remote, please use the macro, `PAC_REMOTE_IO(0...255)`.

iDO_TotalCh

[in] The total number of DO channels of the DO modules.

IDO_Value

[in] The pointer of the DO value to read from the DO module.

Return Values

TRUE indicates success. FALSE indicates failure.

Examples

[VC/VS]

Example 1:

```
// If the module is 87k local
HANDLE hPort;
hPort = uart_Open("COM1,115200,N,8,1");
BYTE slot = 1;
int total_channel = 8;
DWORD do_value;
BOOL ret = pac_ReadDO(hPort, slot , total_channel , &do_value );
uart_Close(hPort);
```

Example 2:

```
// If the module is 8k local
BYTE slot = 1;
int total_channel = 8;
DWORD do_value;
BOOL ret = pac_ReadDO(0, slot , total_channel , &do_value );
```

[C#] for XP-8000 series only

```
// If the module is 87k local
IntPtr hPort;
hPort = XPac.uart_Open("COM1,115200,N,8,1");
byte slot = 1;
int total_channel = 8;
uint do_value;
bool ret = XPac.pac_ReadDO(hPort, slot , total_channel , ref do_value );
XPac.uart_Close(hPort);
```

Remark

The function can support for Local or Remote. When the module is local, the second Parameter's range is from 0 to 7. If remote, the second Parameter need use the macro, PAC_REMOTE_IO(0...255), which range is from 0 to 255.

7.5. pac_ReadDI

This function reads the DI value of the DI module.

Syntax

C++

```
BOOL pac_ReadDI(  
    HANDLE hPort,  
    int slot,  
    int iDI_TotalCh,  
    DWORD *IDI_Value  
);
```

Parameter

hPort

[in] The serial port HANDLE opened by `uart_Open()`, if the module is 87k modules in local.

0, if the module is 8k modules in local.

iSlot

[in] The slot in which module is to receive the command. Default is local.

If the IO module is remote, please use the macro, `PAC_REMOTE_IO(0...255)`.

iDI_TotalCh

[in] The total channels of the DI module.

IDI_Value

[out] The pointer to DI value to read back.

Return Values

TRUE indicates success. FALSE indicates failure.

Examples

[VC/VS]

Example 1:

```
// If the module is 87k local
```

```
HANDLE hPort;  
hPort = uart_Open("COM1,115200,N,8,1");  
BYTE iSlot = 2;  
int iDI_TotalCh = 8;  
DWORD IDI_Value;  
BOOL iRet = pac_ReadDI(hPort, iSlot,iDI_TotalCh, &IDI_Value);  
uart_Close(hPort);
```

Example 2:

```
// If the module is 8k local
```

```
BYTE iSlot = 2;  
int iDI_TotalCh = 8;  
DWORD IDI_Value;  
BOOL iRet = pac_ReadDI(0, iSlot,iDI_TotalCh, &IDI_Value);
```

[C#] for XP-8000 series only

```
// If the module is 87k local
```

```
IntPtr hPort;  
hPort = XPac.uart_Open("COM1,115200,N,8,1");  
byte iSlot = 2;  
int iDI_TotalCh = 8;  
uint IDI_Value;  
bool iRet = XPac.pac_ReadDI(hPort, iSlot,iDI_TotalCh, ref IDI_Value);  
XPac.uart_Close(hPort);
```

Remark

The function can support for Local or Remote. When the module is local, the second Parameter's range is from 0 to 7. If remote, the second Parameter need use the macro, PAC_REMOTE_IO(0...255), which range is from 0 to 255.

7.6. pac_ReadDIO

This function reads the DI and the DO values of the DIO module.

Syntax

C++

```
BOOL pac_ReadDIO(  
    HANDLE hPort,  
    int slot,  
    int iDI_TotalCh,  
    int iDO_TotalCh,  
    DWORD* IDI_Value,  
    DWORD* IDO_Value  
);
```

Parameter

hPort

[in] The serial port HANDLE opened by `uart_Open()`, if the module is 87k modules in local.

0, if the module is 8k modules in local.

iSlot

[in] The slot in which module is to receive the command. Default is local.

If the IO module is remote, please use the macro, `PAC_REMOTE_IO(0...255)`.

iDI_TotalCh

[in] The total number of DI channels of the DIO module.

iDO_TotalCh

[in] The total number of DO channels of the DIO module.

IDI_Value

[out] The pointer to the value of DI read back.

IDO_Value

[out] The pointers to the value of DO read back.

Return Values

TRUE indicates success. FALSE indicates failure.

Examples

[VC/VS]

Example 1:

// If the module is 87k local

```
HANDLE hPort;
hPort = uart_Open("COM1,115200,N,8,1");
BYTE iSlot=1;
int iDI_TotalCh=8;
int iDO_TotalCh=8;
DWORD IDI_Value;
DWORD IDO_Value;
BOOL iRet = pac_ReadDIO(hPort, iSlot,iDI_TotalCh, iDO_TotalCh, &IDI_Value,
&IDO_Value);
uart_Close(hPort);
```

Example 2:

// If the module is 8k local

```
BYTE iSlot=1;
int iDI_TotalCh=8;
int iDO_TotalCh=8;
DWORD IDI_Value;
DWORD IDO_Value;
BOOL iRet = pac_ReadDIO(0, iSlot,iDI_TotalCh, iDO_TotalCh, &IDI_Value,
&IDO_Value);
```

[C#] for XP-8000 series only

```
// If the module is 87k local
IntPtr hPort;
hPort = XPac.udp_Open("COM1,115200,N,8,1");
byte iSlot=1;
int iDI_TotalCh=8;
int iDO_TotalCh=8;
uint IDI_Value;
uint IDO_Value;
bool iRet = XPac.pac_ReadDIO(hPort, iSlot,iDI_TotalCh, iDO_TotalCh, ref
IDI_Value, ref IDO_Value);
XPac.udp_Close(hPort);
```

Remark

The function can support for Local or Remote. When the module is local, the second Parameter's range is from 0 to 7. If remote, the second Parameter need use the macro, PAC_REMOTE_IO (0...255), which range is from 0 to 255.

7.7. pac_ReadDILatch

This function reads the DI latch value of the DI module.

Syntax

C++

```
BOOL pac_ReadDILatch(  
    HANDLE hPort,  
    int slot,  
    int iDI_TotalCh,  
    int iLatchType,  
    DWORD *IDI_Latch_Value  
);
```

Parameter

hPort

[in] The serial port HANDLE opened by `uart_Open()`, if the module is 87k modules in local.

0, if the module is 8k modules in local.

iSlot

[in] The slot in which module is to receive the command. Default is local.

If the IO module is remote, please use the macro, `PAC_REMOTE_IO(0...255)`.

iDI_TotalCh

[in] The total number of the DI channels of the DI module.

iLatchType

[in] The latch type specified to read latch value back.

1 = latched high status

0 = latched low status

IDI_Latch_Value

[out] The pointer to the latch value read back from the DI module.

Return Values

TRUE indicates success. FALSE indicates failure.

Examples

[VC/VS]

Example 1:

```
// If the module is 87k local
HANDLE hPort;
hPort = uart_Open("COM1,115200,N,8,1");
BYTE iSlot=1;
int iDI_TotalCh=8;
int iLatchType=0;
DWORD IDI_Latch_Value;
BOOL iRet = pac_ReadDILatch(hPort, iSlot, iDI_TotalCh, iLatchType,
&IDI_Latch_Value);
uart_Close(hPort);
```

Example 2:

```
// If the module is 8k local
BYTE iSlot=1;
int iDI_TotalCh=8;
int iLatchType=0;
DWORD IDI_Latch_Value;
BOOL iRet = pac_ReadDILatch(0, iSlot, iDI_TotalCh, iLatchType,
&IDI_Latch_Value);
```

[C#] for XP-8000 series only

```
// If the module is 87k local
IntPtr hPort;
hPort = XPac.uart_Open("COM1,115200,N,8,1");
byte iSlot=1;
int iDI_TotalCh=8;
int iLatchType=0;
uint IDI_Latch_Value;
bool iRet = XPac.pac_ReadDILatch(hPort, iSlot, iDI_TotalCh, iLatchType, ref
IDI_Latch_Value);
XPac.uart_Close(hPort);
```

Remark

The function can support for Local or Remote. When the module is local, the second Parameter's range is from 0 to 7. If remote, the second Parameter need use the macro, PAC_REMOTE_IO(0...255), which range is from 0 to 255.

7.8. pac_ClearDILatch

This function clears the latch value of the DI module.

Syntax

C++

```
BOOL pac_ClearDILatch(  
    HANDLE hPort,  
    int slot  
);
```

Parameter

hPort

[in] The serial port HANDLE opened by `uart_Open()`, if the module is 87k modules in local.

0, if the module is 8k modules in local.

iSlot

[in] The slot in which module is to receive the command. Default is local.

If the IO module is remote, please use the macro, `PAC_REMOTE_IO(0...255)`.

Return Values

TRUE indicates success. FALSE indicates failure.

Examples

[VC/VS]

Example 1:

```
// If the module is 87k local
HANDLE hPort;
hPort = uart_Open("COM1,115200,N,8,1");
BYTE iSlot=1;
BOOL iRet = pac_ClearDILatch(hPort, iSlot);
uart_Close(hPort);
```

Example 2:

```
// If the module is 8k local
BYTE iSlot=1;
BOOL iRet = pac_ClearDILatch(0, iSlot);
```

[C#] for XP-8000 series only

```
// If the module is 87k local
IntPtr hPort;
hPort = XPac.uart_Open("COM1,115200,N,8,1");
byte iSlot=1;
bool iRet = pac_ClearDILatch(hPort, iSlot);
XPac.uart_Close(hPort);
```

Remark

The function can support for Local or Remote. When the module is local, the second Parameter's range is from 0 to 7. If remote, the second Parameter need use the macro, PAC_REMOTE_IO(0...255), which range is from 0 to 255.

7.9. pac_ReadDIOLatch

This function reads the latch values of the DI and DO channels of the DIO module.

Syntax

C++

```
BOOL pac_ReadDIOLatch(  
    HANDLE hPort,  
    int slot,  
    int iDI_TotalCh,  
    int iDO_TotalCh,  
    int iLatchType,  
    DWORD *IDI_Latch_Value,  
    DWORD *IDO_Latch_Value  
);
```

Parameter

hPort

[in] The serial port HANDLE opened by `uart_Open()`, if the module is 87k modules in local.

0, if the module is 8k modules in local.

iSlot

[in] The slot in which module is to receive the command. Default is local.

If the IO module is remote, please use the macro, `PAC_REMOTE_IO(0...255)`.

iDI_TotalCh

[in] The total number of the DI channels of the DIO module.

iDO_TotalCh

[in] The total number of the DO channels of the DIO module.

iLatchType

[in] The type of the latch value read back.

1 = latched high status

0 = latched low status

IDI_Latch_Value

[out] The pointer to the DI latch value read back.

IDO_Latch_Value

[out] The pointer to the DO latch value read back.

Return Values

TRUE indicates success. FALSE indicates failure.

Examples

[VC/VS]

Example 1:

```
// If the module is 87k local
```

```
HANDLE hPort;  
hPort = uart_Open("COM1,115200,N,8,1");  
BYTE iSlot=1;  
int iDI_TotalCh=8;  
int iDO_TotalCh=8;  
int iLatchType=0;  
DWORD IDI_Latch_Value;  
DWORD IDO_Latch_Value;  
BYTE cDI_Latch_BitValue;  
BYTE cDO_Latch_BitValue;  
BOOL iRet = pac_ReadDIOLatch(hPort, iSlot,iDI_TotalCh,iDO_TotalCh,iLatchType,  
&IDI_Latch_Value,&IDO_Latch_Value);  
uart_Close(hPort);
```

Example 2:

```
// If the module is 8k local
```

```
BYTE iSlot=1;  
int iDI_TotalCh=8;  
int iDO_TotalCh=8;  
int iLatchType=0;  
DWORD IDI_Latch_Value;  
DWORD IDO_Latch_Value;  
BYTE cDI_Latch_BitValue;  
BYTE cDO_Latch_BitValue;  
BOOL iRet = pac_ReadDIOLatch(0, iSlot,iDI_TotalCh,iDO_TotalCh,iLatchType,  
&IDI_Latch_Value,&IDO_Latch_Value);
```

[C#] for XP-8000 series only

```
// If the module is 87k local
IntPtr hPort;
hPort = XPac.udp_Open("COM1,115200,N,8,1");
byte iSlot=1;
int iDI_TotalCh=8;
int iDO_TotalCh=8;
int iLatchType=0;
uint IDI_Latch_Value;
uint IDO_Latch_Value;
byte cDI_Latch_BitValue;
byte cDO_Latch_BitValue;
bool iRet = XPac.pac_ReadDIOLatch(hPort,
iSlot,iDI_TotalCh,iDO_TotalCh,iLatchType, ref IDI_Latch_Value, ref
IDO_Latch_Value);
XPac.udp_Close(hPort);
```

Remark

The function can support for Local or Remote. When the module is local, the second Parameter's range is from 0 to 7. If remote, the second Parameter need use the macro, PAC_REMOTE_IO(0...255), which range is from 0 to 255.

7.10. pac_ClearDIOLatch

This function clears the latch values of DI and DO channels of the DIO module.

Syntax

C++

```
BOOL pac_ClearDIOLatch(  
    HANDLE hPort,  
    int slot  
);
```

Parameter

hPort

[in] The serial port HANDLE opened by `uart_Open()`, if the module is 87k modules in local.

0, if the module is 8k modules in local.

iSlot

[in] The slot in which module is to receive the command. Default is local.

If the IO module is remote, please use the macro, `PAC_REMOTE_IO` (0...255).

Return Values

TRUE indicates success. FALSE indicates failure.

Examples

[VC/VS]

Example 1:

```
// If the module is 87k local
HANDLE hPort;
hPort = uart_Open("COM1,115200,N,8,1");
BYTE iSlot=1;
BOOL iRet = pac_ClearDIOLatch(hPort, iSlot);
uart_Close(hPort);
```

Example 2:

```
// If the module is 8k local
BYTE iSlot=1;
BOOL iRet = pac_ClearDIOLatch(0, iSlot);
```

[C#] for XP-8000 series only

```
// If the module is 87k local
IntPtr hPort;
hPort = XPac.uart_Open("COM1,115200,N,8,1");
byte iSlot=1;
bool iRet = XPac.pac_ClearDIOLatch(hPort, iSlot);
XPac.uart_Close(hPort);
```

Remark

The function can support for Local or Remote. When the module is local, the second Parameter's range is from 0 to 7. If remote, the second Parameter need use the macro, PAC_REMOTE_IO (0...255), which range is from 0 to 255.

7.11. pac_ReadDICNT

This function reads the counts of the DI channels of the DI module.

Syntax

C++

```
BOOL pac_ReadDICNT(  
    HANDLE hPort,  
    int slot,  
    int iChannel,  
    int iDI_TotalCh,  
    DWORD *ICounter_Value  
);
```

Parameter

hPort

[in] The serial port HANDLE opened by `uart_Open()`, if the module is 87k modules in local.

0, if the module is 8k modules in local.

iSlot

[in] The slot in which module is to receive the command. Default is local.

If the IO module is remote, please use the macro, `PAC_REMOTE_IO(0...255)`.

iChannel

[in] The channel that the counter value belongs.

iDI_TotalCh

[in] Total number of the DI channels of the DI module.

ICounter_Value

[out] The pointer to the counter value.

Return Values

TRUE indicates success. FALSE indicates failure.

Examples

[VC/VS]

Example 1:

```
// If the module is 87k local
HANDLE hPort;
hPort = uart_Open("COM1,115200,N,8,1");
BYTE iSlot=1;
int iChannel =2;
int iDI_TotalCh=8;
DWORD ICounter_Value;
BOOL iRet = pac_ReadDICNT(hPort, iSlot,iChannel,iDI_TotalCh,
&ICounter_Value);
uart_Close(hPort);
```

Example 2:

```
// If the module is 8k local
BYTE iSlot=1;
int iChannel =2;
int iDI_TotalCh=8;
DWORD ICounter_Value;
BOOL iRet = pac_ReadDICNT(0, iSlot,iChannel,iDI_TotalCh, &ICounter_Value);
```

[C#] for XP-8000 series only

```
// If the module is 87k local
IntPtr hPort;
hPort = XPac.uart_Open("COM1,115200,N,8,1");
byte iSlot=1;
int iChannel =2;
int iDI_TotalCh=8;
uint ICounter_Value;
bool iRet = XPac.pac_ReadDICNT(hPort, iSlot,iChannel,iDI_TotalCh, ref
ICounter_Value);
XPac.uart_Close(hPort);
```

Remark

The function can support for Local or Remote. When the module is local, the second Parameter's range is from 0 to 7. If remote, the second Parameter need use the macro, PAC_REMOTE_IO(0...255), which range is from 0 to 255.

7.12. pac_ClearDICNT

This function clears the counter value of the DI channel of the DI module.

Syntax

C++

```
BOOL pac_ClearDICNT(  
    HANDLE hPort,  
    int slot,  
    int iChannel,  
    int iDI_TotalCh  
);
```

Parameter

hPort

[in] The serial port HANDLE opened by `uart_Open()`, if the module is 87k modules in local.

0, if the module is 8k modules in local.

iSlot

[in] The slot in which module is to receive the command. Default is local.

If the IO module is remote, please use the macro, `PAC_REMOTE_IO(0...255)`.

iChannel

[in] The channel that the counter value belongs.

iDI_TotalCh

[in] Total number of the DI channels of the DI module.

Return Values

TRUE indicates success. FALSE indicates failure.

Examples

[VC/VS]

Example 1:

```
// If the module is 87k local
```

```
HANDLE hPort;  
hPort = uart_Open("COM1,115200,N,8,1");  
BYTE iSlot=1;  
int iChannel=2;  
int iDI_TotalCh=8;  
BOOL iRet = pac_ClearDICNT(hPort, iSlot,iChannel,iDI_TotalCh);  
uart_Close(hPort);
```

Example 2:

```
// If the module is 8k local
```

```
BYTE iSlot=1;  
int iChannel=2;  
int iDI_TotalCh=8;  
BOOL iRet = pac_ClearDICNT(0, iSlot,iChannel,iDI_TotalCh);
```

[C#] for XP-8000 series only

```
// If the module is 87k local
```

```
IntPtr hPort;  
hPort = XPac.uart_Open("COM1,115200,N,8,1");  
byte iSlot=1;  
int iChannel=2;  
int iDI_TotalCh=8;  
bool iRet = XPac.pac_ClearDICNT(hPort, iSlot,iChannel,iDI_TotalCh);  
XPac.uart_Close(hPort);
```

Remark

The function can support for Local or Remote. When the module is local, the second Parameter's range is from 0 to 7. If remote, the second Parameter need use the macro, PAC_REMOTE_IO(0...255), which range is from 0 to 255.

7.13. pac_WriteAO

This function writes the AO value to the AO modules.

Syntax

C++

```
BOOL pac_WriteAO(  
    HANDLE hPort,  
    int slot,  
    int iChannel,  
    int iAO_TotalCh,  
    float fValue  
);
```

Parameter

hPort

[in] The serial port HANDLE opened by `uart_Open()`, if the module is 87k modules in local.

0, if the module is 8k modules in local.

iSlot

[in] The slot in which module is to receive the command. Default is local.

If the IO module is remote, please use the macro, `PAC_REMOTE_IO(0...255)`.

iChannel

[in] The channel that is written the AO value to.

iAO_TotalCh

[in] The total number of the AO channels of the AO module.

float fValue

[in] The AO value to write to the AO module.

Return Values

TRUE indicates success. FALSE indicates failure.

Examples

[VC/VS]

Example 1:

```
// If the module is 87k local
```

```
HANDLE hPort;  
hPort = uart_Open("COM1,115200,N,8,1");  
BYTE iSlot=1;  
int iChannel=2;  
int iAO_TotalCh=8;  
float fValue=5;  
BOOL iRet = pac_WriteAO(hPort, iSlot,iChannel,iAO_TotalCh,fValue);  
uart_Close(hPort);
```

Example 2:

```
// If the module is 8k local
```

```
BYTE iSlot=1;  
int iChannel=2;  
int iAO_TotalCh=8;  
float fValue=5;  
BOOL iRet = pac_WriteAO(0, iSlot,iChannel,iAO_TotalCh,fValue);
```

[C#] for XP-8000 series only

```
// If the module is 87k local
IntPtr hPort;
hPort = XPac.uart_Open("COM1,115200,N,8,1");
byte iSlot=1;
int iChannel=2;
int iAO_TotalCh=8;
float fValue=5;
bool iRet = XPac.pac_WriteAO(hPort, iSlot,iChannel,iAO_TotalCh,fValue);
XPac.uart_Close(hPort);
```

Remark

The function can support for Local or Remote. When the module is local, the second Parameter's range is from 0 to 7. If remote, the second Parameter need use the macro, PAC_REMOTE_IO (0...255), which range is from 0 to 255.

7.14. pac_ReadAO

This function reads the AO value of the AO module.

Syntax

C++

```
BOOL pac_ReadAO(  
    HANDLE hPort,  
    int slot,  
    int iChannel,  
    int iAO_TotalCh,  
    float *fValue  
);
```

Parameter

hPort

[in] The serial port HANDLE opened by `uart_Open()`, if the module is 87k modules in local.

0, if the module is 8k modules in local.

iSlot

[in] The slot in which module is to receive the command. Default is local.

If the IO module is remote, please use the macro, `PAC_REMOTE_IO(0...255)`.

iChannel

[in] Read the AO value from the channel.

iAO_TotalCh

[in] The total number of the AO channels of the AO module.

float fValue

[in] The pointer to the AO value that is read back from the AO module.

Return Values

TRUE indicates success. FALSE indicates failure.

Examples

[VC/VS]

Example 1:

```
// If the module is 87k local
HANDLE hPort;
hPort = uart_Open("COM1,115200,N,8,1");
BYTE iSlot=1;
int iChannel=2;
int iAO_TotalCh=8;
float fValue;
BOOL iRet = pac_ReadAO(hPort, iSlot,iChannel,iAO_TotalCh, &fValue);
uart_Close(hPort);
```

Example 2:

```
// If the module is 8k local
BYTE iSlot=1;
int iChannel=2;
int iAO_TotalCh=8;
float fValue;
BOOL iRet = pac_ReadAO(0, iSlot,iChannel,iAO_TotalCh, &fValue);
```

[C#] for XP-8000 series only

```
// If the module is 87k local
IntPtr hPort;
hPort = XPac.uart_Open("COM1,115200,N,8,1");
byte iSlot=1;
int iChannel=2;
int iAO_TotalCh=8;
float fValue;
bool iRet = XPac.pac_ReadAO(hPort, iSlot,iChannel,iAO_TotalCh,ref fValue);
XPac.uart_Close(hPort);
```

Remark

The function can support for Local or Remote. When the module is local, the second Parameter's range is from 0 to 7. If remote, the second Parameter need use the macro, PAC_REMOTE_IO (0...255), which range is from 0 to 255.

7.15. pac_ReadAI

This function reads the engineering-mode AI value of the AI module.

Syntax

C++

```
BOOL pac_ReadAI(  
    HANDLE hPort,  
    int slot,  
    int iChannel,  
    int iAI_TotalCh,  
    float *fValue  
);
```

Parameter

hPort

[in] The serial port HANDLE opened by `uart_Open()`, if the module is 87k modules in local.

0, if the module is 8k modules in local.

iSlot

[in] The slot in which module is to receive the command. Default is local.

If the IO module is remote, please use the macro, `PAC_REMOTE_IO(0...255)`.

iChannel

[in] Read the AI value from the channel.

iAI_TotalCh

[in] The total number of the AI channels of the AI module.

fValue

[in] The pointer to the AI value that is read back from the AI module.

Return Values

TRUE indicates success. FALSE indicates failure.

Examples

[VC/VS]

Example 1:

```
// If the module is 87k local
HANDLE hPort;
hPort = uart_Open("COM1,115200,N,8,1");
BYTE iSlot=1;
int iChannel=2;
int iAI_TotalCh=8;
float fValue;
BOOL iRet = pac_ReadAI(hPort, iSlot,iChannel,iAI_TotalCh, &fValue);
uart_Close(hPort);
```

Example 2:

```
// If the module is 8k local
BYTE iSlot=1;
int iChannel=2;
int iAI_TotalCh=8;
float fValue;
BOOL iRet = pac_ReadAI(0, iSlot,iChannel,iAI_TotalCh, &fValue);
```

[C#] for XP-8000 series only

```
// If the module is 87k local
IntPtr hPort;
hPort = XPac.uart_Open("COM1,115200,N,8,1");
byte iSlot=1;
int iChannel=2;
int iAI_TotalCh=8;
float fValue;
bool iRet = XPac.pac_ReadAI(hPort, iSlot,iChannel,iAI_TotalCh, ref fValue);
XPac.uart_Close(hPort);
```

Remark

The function can support for Local or Remote. When the module is local, the second Parameter's range is from 0 to 7. If remote, the second Parameter need use the macro, PAC_REMOTE_IO (0...255), which range is from 0 to 255.

7.16. pac_ReadAIHex

This function reads the 2's complement-mode AI value of the AI module.

Syntax

C++

```
BOOL pac_ReadAIHex(  
    HANDLE hPort,  
    int slot,  
    int iChannel,  
    int iAI_TotalCh,  
    int *iValue  
);
```

Parameter

hPort

[in] The serial port HANDLE opened by `uart_Open()`, if the module is 87k modules in local.

0, if the module is 8k modules in local.

iSlot

[in] The slot in which module is to receive the command. Default is local.

If the IO module is remote, please use the macro, `PAC_REMOTE_IO(0...255)`.

iChannel

[in] Read the AI value from the channel.

iAI_TotalCh

[in] The total number of the AI channels of the AI module.

iValue

[in] The pointer to the AI value that is read back from the AI module.

Return Values

TRUE indicates success. FALSE indicates failure.

Examples

[VC/VS]

Example 1:

```
// If the module is 87k local
```

```
HANDLE hPort;
```

```
hPort = uart_Open("COM1,115200,N,8,1");
```

```
BYTE iSlot=1;
```

```
int iChannel=2;
```

```
int iAI_TotalCh=8;
```

```
int iValue;
```

```
BOOL iRet = pac_ReadAIHex(hPort, iSlot,iChannel,iAI_TotalCh, &iValue);
```

```
uart_Close(hPort);
```

Example 2:

```
// If the module is 8k local
```

```
BYTE iSlot=1;
```

```
int iChannel=2;
```

```
int iAI_TotalCh=8;
```

```
int iValue;
```

```
BOOL iRet = pac_ReadAIHex(0, iSlot,iChannel,iAI_TotalCh, &iValue);
```

[C#] for XP-8000 series only

```
// If the module is 87k local
IntPtr hPort;
hPort = XPac.uart_Open("COM1,115200,N,8,1");
byte iSlot=1;
int iChannel=2;
int iAI_TotalCh=8;
int iValue;
bool iRet = XPac.pac_ReadAIHex(hPort, iSlot,iChannel,iAI_TotalCh, ref iValue);
XPac.uart_Close(hPort);
```

Remark

The function can support for Local or Remote. When the module is local, the second Parameter's range is from 0 to 7. If remote, the second Parameter need use the macro, PAC_REMOTE_IO (0...255), which range is from 0 to 255.

7.17. pac_ReadAIAI

This function reads all the AI values of all channels in engineering-mode of the AI module.

Syntax

C++

```
BOOL pac_ReadAIAI(  
    HANDLE hPort,  
    int slot,  
    float fValue[]  
);
```

Parameter

hPort

[in] The serial port HANDLE opened by `uart_Open()`, if the module is 87k modules in local.

0, if the module is 8k modules in local.

iSlot

[in] The slot in which module is to receive the command. Default is local.

If the IO module is remote, please use the macro, `PAC_REMOTE_IO(0...255)`.

fValue[]

[out] The array contains the AI values that read back from the AI module.

Return Values

TRUE indicates success. FALSE indicates failure.

Examples

[VC/VS]

Example 1:

```
// If the module is 87k local
HANDLE hPort;
hPort = uart_Open("COM1,115200,N,8,1");
BYTE iSlot=1;
float fValue[8];
BOOL iRet = pac_ReadAll(hPort, iSlot, fValue);
uart_Close(hPort);
```

Example 2:

```
// If the module is 8k local
BYTE iSlot=1;
float fValue[8];
BOOL iRet = pac_ReadAll(0, iSlot, fValue);
```

[C#] for XP-8000 series only

```
// If the module is 87k local
IntPtr hPort;
hPort = XPac.uart_Open("COM1,115200,N,8,1");
byte iSlot=1;
float fValue[8];
bool iRet = pac_ReadAll(hPort, iSlot, fValue);
XPac.uart_Close(hPort);
```

Remark

The function can support for Local or Remote. When the module is local, the second Parameter's range is from 0 to 7. If remote, the second Parameter need use the macro, PAC_REMOTE_IO (0...255), which range is from 0 to 255.

7.18. pac_ReadAIAllHex

This function reads all the AI values of all channels in 2's complement-mode of the AI module.

Syntax

C++

```
BOOL pac_ReadAIAllHex(  
    HANDLE hPort,  
    int slot,  
    int iValue[]  
);
```

Parameter

hPort

[in] The serial port HANDLE opened by `uart_Open()`, if the module is 87k modules in local.

0, if the module is 8k modules in local.

iSlot

[in] The slot in which module is to receive the command. Default is local.

If the IO module is remote, please use the macro, `PAC_REMOTE_IO` (0...255).

iValue[]

[out] The array contains the AI values that read back from the AI module.

Return Values

TRUE indicates success. FALSE indicates failure.

Examples

[VC/VS]

Example 1:

```
// If the module is 87k local
HANDLE hPort;
hPort = uart_Open("COM1,115200,N,8,1");
BYTE iSlot=1;
int iValue[8];
BOOL iRet = pac_ReadAllHex(hPort, iSlot, iValue);
uart_Close(hPort);
```

Example 2:

```
// If the module is 8k local
BYTE iSlot=1;
int iValue[8];
BOOL iRet = pac_ReadAllHex(0, iSlot, iValue);
```

[C#] for XP-8000 series only

```
// If the module is 87k local
IntPtr hPort;
hPort = XPac.uart_Open("COM1,115200,N,8,1");
byte iSlot=1;
int iValue[8];
bool iRet = XPac.pac_ReadAllHex(hPort, iSlot, iValue);
XPac.uart_Close(hPort);
```

Remark

The function can support for Local or Remote. When the module is local, the second Parameter's range is from 0 to 7. If remote, the second Parameter need use the macro, PAC_REMOTE_IO (0...255), which range is from 0 to 255.

7.19. pac_ReadCNT

This function reads the counter values of the counter/frequency modules.

Syntax

C++

```
BOOL pac_ReadCNT(  
    HANDLE hPort,  
    int slot,  
    int iChannel,  
    DWORD *ICounter_Value  
);
```

Parameter

hPort

[in] The serial port HANDLE opened by `uart_Open()`, if the module is 87k modules in local.

0, if the module is 8k modules in local.

iSlot

[in] The slot in which module is to receive the command. Default is local.

If the IO module is remote, please use the macro, `PAC_REMOTE_IO(0...255)`.

iChannel

[in] The channel that reads the counter value back from the counter/frequency module.

ICounter_Value

[out] The pointer to the counter value that reads back from the counter/frequency module.

Return Values

TRUE indicates success. FALSE indicates failure.

Examples

[VC/VS]

Example 1:

```
// If the module is 87k local
HANDLE hPort;
hPort = uart_Open("COM1,115200,N,8,1");
BYTE iSlot=1;
int iChannel=0;
DWORD ICounter_Value;
BOOL iRet = pac_ReadCNT(hPort, iSlot,iChannel,&ICounter_Value);
uart_Close(hPort);
```

Example 2:

```
// If the module is 8k local
BYTE iSlot=1;
int iChannel=0;
DWORD ICounter_Value;
BOOL iRet = pac_ReadCNT(0, iSlot,iChannel,&ICounter_Value);
```

[C#] for XP-8000 series only

```
// If the module is 87k local
IntPtr hPort;
hPort = XPac.uart_Open("COM1,115200,N,8,1");
byte iSlot=1;
int iChannel=0;
uint ICounter_Value;
bool iRet = XPac.pac_ReadCNT(hPort, iSlot,iChannel,ref ICounter_Value);
XPac.uart_Close(hPort);
```

Remark

The function can support for Local or Remote. When the module is local, the second Parameter's range is from 0 to 7. If remote, the second Parameter need use the macro, PAC_REMOTE_IO (0...255), which range is from 0 to 255.

7.20. pac_ClearCNT

This function clears the counter values of the counter/frequency modules.

Syntax

C++

```
BOOL pac_ClearCNT(  
    HANDLE hPort,  
    int slot,  
    int iChannel  
);
```

Parameter

hPort

[in] The serial port HANDLE opened by `uart_Open()`, if the module is 87k modules in local.

0, if the module is 8k modules in local.

iSlot

[in] The slot in which module is to receive the command. Default is local.

If the IO module is remote, please use the macro, `PAC_REMOTE_IO(0...255)`.

iChannel

[in] The channel that clears the counter value back from the counter/frequency modules.

Return Values

TRUE indicates success. FALSE indicates failure.

Examples

[VC/VS]

Example 1:

```
// If the module is 87k local
```

```
HANDLE hPort;  
hPort = uart_Open("COM1,115200,N,8,1");  
BYTE iSlot=1;  
int iChannel=0;  
BOOL iRet = pac_ClearCNT(hPort, iSlot, iChannel);  
uart_Close(hPort);
```

Example 2:

```
// If the module is 8k local
```

```
BYTE iSlot=1;  
int iChannel=0;  
BOOL iRet = pac_ClearCNT(0, iSlot, iChannel);
```

[C#] for XP-8000 series only

```
// If the module is 87k local
```

```
IntPtr hPort;  
hPort = XPac.uart_Open("COM1,115200,N,8,1");  
byte iSlot=1;  
int iChannel=0;  
bool iRet = XPac.pac_ClearCNT(hPort, iSlot, iChannel);  
XPac.uart_Close(hPort);
```

Remark

The function can support for Local or Remote. When the module is local, the second Parameter's range is from 0 to 7. If remote, the second Parameter need use the macro, PAC_REMOTE_IO (0...255), which range is from 0 to 255.

7.21. pac_ReadCNTOverflow

This function clears the counter overflow value of the counter/frequency modules.

Syntax

C++

```
BOOL pac_ReadCNTOverflow(  
    HANDLE hPort,  
    int slot,  
    int iChannel,  
    int *iOverflow  
);
```

Parameter

hPort

[in] The serial port HANDLE opened by `uart_Open()`, if the module is 87k modules in local.

0, if the module is 8k modules in local.

iSlot

[in] The slot in which module is to receive the command. Default is local.

If the IO module is remote, please use the macro, `PAC_REMOTE_IO` (0...255).

iChannel

[in] The channel that reads the counter overflows value back from the counter/frequency module.

iOverflow

[out] The pointer to the counter overflow that is read back from the counter/frequency module.

Return Values

TRUE indicates success. FALSE indicates failure.

Examples

[VC/VS]

Example 1:

```
// If the module is 87k local
```

```
HANDLE hPort;  
hPort = uart_Open("COM1,115200,N,8,1");  
BYTE iSlot=1;  
int iChannel=0;  
int iOverflow;  
BOOL iRet = pac_ReadCNT_Overflow(hPort, iSlot,iChannel,&iOverflow);  
uart_Close(hPort);
```

Example 2:

```
// If the module is 8k local
```

```
BYTE iSlot=1;  
int iChannel=0;  
int iOverflow;  
BOOL iRet = pac_ReadCNT_Overflow(0, iSlot,iChannel,&iOverflow);
```

[C#] for XP-8000 series only

```
// If the module is 87k local
```

```
IntPtr hPort;  
hPort = XPac.uart_Open("COM1,115200,N,8,1");  
byte iSlot=1;  
int iChannel=0;  
int iOverflow;  
bool iRet = XPac.pac_ReadCNT_Overflow(hPort, iSlot,iChannel,ref iOverflow);  
XPac.uart_Close(hPort);
```

Remark

The function can support for Local or Remote. When the module is local, the second Parameter's range is from 0 to 7. If remote, the second Parameter need use the macro, PAC_REMOTE_IO (0...255), which range is from 0 to 255.

8. Backplane timer API

Backplane timer Reference

Backplane timer API supports to hardware timer including timerout/timer1/timer2.

Supported Modules

The following shows the overview of the backplane timer functions which are available with WinPAC.

Functions\Models	XP-8000 (WES)	XP-8000-CE6	XP-8000-Atom (WES)	XP-8000-Atom- CE6
pac_GetBPTimerTimeTick_ms	N	Y	N	N
pac_GetBPTimerTimeTick_us	N	Y	N	N
pac_KillBPTimer	N	Y	N	N
pac_SetBPTimer	N	Y	N	N
pac_SetBPTimerOut	N	Y	N	N
pac_SetBPTimerInterruptPriority	N	Y	N	N

Function List

The following functions are used to retrieve or set backplane timer functions.

Function	Description
<code>pac_GetBPTimerTimeTick_ms</code>	This function returns the number of milliseconds since the device booted, excluding any time that the system was suspended.
<code>pac_GetBPTimerTimeTick_us</code>	This function returns the number of microsecond since the device booted, excluding any time that the system was suspended.
<code>pac_KillBPTimer</code>	This function kills the timer event identified by type, set by an earlier call to <code>pac_SetBPTimer</code> .
<code>pac_SetBPTimer</code>	This function installs a hardware timer. A time-out value is specified, and every time a time-out occurs, the system posts an interrupt signal to the system and the pass the message to an application-defined callback function.
<code>pac_SetBPTimerOut</code>	This function installs a hardware timer.
<code>pac_SetBPTimerInterruptPriority</code>	This function sets the priority for a real-time thread of the backplane timer.

8.1. pac_GetBPTimerTimeTick_ms

This function returns the number of milliseconds since the device booted, excluding any time that the system was suspended.

Syntax

C++

```
DWORD pac_GetBPTimerTimeTick_ms(void);
```

Parameters

None

Return Values

The number of milliseconds indicates success.

Examples

None

8.2. pac_GetBPTimerTimeTick_us

This function returns the number of microsecond since the device booted, excluding any time that the system was suspended.

Syntax

C++

```
DWORD pac_GetBPTimerTimeTick_us (void);
```

Parameters

None

Return Values

The number of microseconds indicates success.

Examples

None

8.3. pac_SetBPTimer

This function installs a hardware timer. A time-out value is specified, and every time a time-out occurs, the system posts an interrupt signal to the system and the pass the message to an application-defined callback function.

Syntax

C++

```
Bool pac_SetBPTimer(int type,unsigned int uElapse,  
pac_TIMEROUT_CALLBACK_FUNC f);
```

Parameters

type

[in] Two type timer, 1 microsecond timer and 10 microseconds timer

1 (Timer 1): 1 microsecond timer

2 (Timer 2): 10 microsecond timer

Others: Not applicable

uElapse

[in]

Timer 1: Specifies the elapses time value for a timerout signal 0~65535, in microseconds.

Timer 2: Specifies the elapses time value for a timerout signal 0~65535, in 10 microseconds.

f

Specifies the address of the application-supplied f callback function.

Return Values

The value is true if the function was installed successfully. It is zero and the function cannot be installed.

Examples

[VC]

```
int CALLBACK TIMER() //Interrupt Function
{
    /*Add the user control code here*/
    return 0; // Interrupt done
}
// Set timer1 with 200 microsecond interval
pac_SetBPTimer(1, 200, TIMER);
```

8.4. pac_SetBPTimerOut

This function installs a hardware timer. The time-out value of high/low wave are specified, and every time the time-out of high wave and low wave occur, the system posts an interrupt signal to the system and then pass the message to an application-defined callback function.

The timerout pin on each slot will be triggered while a timerout signal has been outputted. The timerout pin can be used to acquire the synchronized data on each slot.

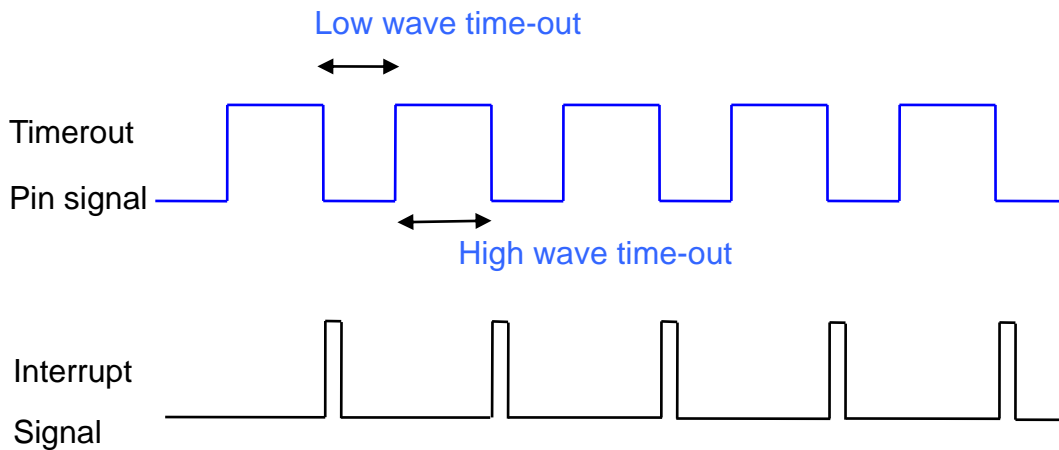

Syntax

C++

```
bool pac_SetBPTimerOut(unsigned int uHighElapse,unsigned int uLOWElapse,  
pac_TIMEROUT_CALLBACK_FUNC f);
```

Parameters

uHighElapse

[in] Specifies the elapses time value for a high wave of the timerout signal
0~65535, in microseconds.

uLowElapse

[in] Specifies the elapses time value for a low wave of the timerout signal
0~65535, in microseconds.

f

Specifies the address of the application-supplied f callback function.

Return Values

The value is true if the function was installed successfully. It is zero and the function cannot be installed.

Examples

[VC]

```
int CALLBACK TIMER() //Interrupt Function
{
    /*Add the user control code here*/
    return 0; // Interrupt done
}
// Set timer1 with 200 microsecond interval
pac_SetBPTimerOut (200, 300, TIMER);
```

8.5. pac_SetBPTimerInterruptPriority

This function sets the priority for a real-time thread of the backplane timer.

Syntax

C++

```
bool pac_SetBPTimerInterruptPriority(int type, int nPriority);
```

Parameters

type

[in] Specifies the backplane timer type

0: Timerout

1: Timer 1

2: Timer 2

nPriority

[in] Priority to set for the thread

This value can range from 0 through 255, with 0 as the highest priority.

Return Values

Return true if success, otherwise false.

Examples

[VC]

```
int CALLBACK TIMER() //Interrupt Function
{
    /*Add the user control code here*/
    return 0; // Interrupt done
}
// Set timer1 with 200 microsecond interval
pac_SetBPTimer (1, 200, TIMER);
// Set the priority of timer 1 to 100
pac_SetBPTimerInterruptPriority(1, 100);
```

8.6. pac_KillBPTimer

This function kills the timer event identified by type, set by an earlier call to `pac_SetBPTimer`.

Syntax

C++

```
void pac_KillBPTimer(int type);
```

Parameters

type

[in] Two type timer, 1 microsecond timer and 10 microsecond timer

0 (Timeout)

1 (Timer 1): 1 microsecond timer

2 (Timer 2): 10 microsecond timer

Return Values

None

Examples

[VC]

```
// Destroy the timer 1  
pac_KillBPTimer(1);
```

9. Error Handling API

Supported Modules

The following shows the overview of the error handling functions which are available with XPAC.

Functions\Models	XP-8000 (WES)	XP-8000-CE6	XP-8000-Atom (WES)	XP-8000-Atom -CE6
pac_GetLastError	Y	Y	Y	Y
pac_SetLastError	Y	Y	Y	Y
pac_GetErrorMessage	Y	Y	Y	Y
pac_ClearLastError	Y	Y	Y	Y

Function List

The following functions are used to retrieve or set error handling functions.

Function	Description
pac_GetLastError	This function returns the last-error code value.
pac_SetLastError	This function sets the last-error code.
pac_GetErrorMessage	This function retrieves a message string.
pac_ClearLastError	This function clears the last-error code.

9.1. pac_GetLastError

This function returns the last-error code value.

Syntax

C++

```
DWORD pac_GetLastError();
```

Parameter

None

Return Values

The Return Value section of each reference page notes the conditions under which the function sets the last-error code.

Examples

None

Remark

You should call the `pac_GetLastError` function immediately when a function's return value indicates that such a call will return useful data. That is because some functions call `pac_SetLastError(0)` when they succeed, wiping out the error code set by the most recently failed function.

For an example, please refer to `pac_GetErrorMessage` in this document.

To obtain an error string for XPac error codes, use the `pac_GetErrorMessage` function. For a complete list of error codes, see Error Values or the SDK header file `XPacSDK.h` for XP-8000 series or `XPacSDK_CE.h` for XPAC_CE

Error Type	Explanation	Reange
PAC_ERR_SUCCESS	No error, success	0x00000
PAC_ERR_UNKNOWN	Error which is undeifiend	0x00001
Basic	Defined comman error conditions	0x10000 ~
Memory	About memory access	0x11000 ~
WatchDog	About watchdog	0x12000 ~
Interrupt	About interrupt	0x13000 ~
UART	About uart protocol	0x14000 ~
IO	About IO modules	0x15000 ~
Users	For user	0x20000 ~

9.2. pac_SetLastError

This function sets the last-error code.

Syntax

C++

```
void pac_SetLastError(  
    DWORD errno  
);
```

Parameter

errno

[in] Specifies the last-error code.

Return Values

None

Examples

None

Remark

Applications can optionally retrieve the value set by this function by using the `pac_GetLastError` function.

Error codes are DWORD values. If you are defining an error code for your application, ensure that your error code does not conflict with any XPacSDK-defined error codes.

We recommend that your error code should be greater than 0x20000.

For more information about the definition of error codes, please refer to `pac_GetLastError` in this document.

9.3. pac_GetErrorMessage

This function retrieves a message string.

Syntax

C++

```
void pac_GetErrorMessage(  
    DWORD dwMessageID,  
    LPTSTR lpBuffer  
);
```

Parameter

dwMessageID

[in] Specifies the 32-bit message identifier for the requested message.

lpBuffer

[out] Pointer to a buffer for the error message.

Return Values

None

Example

[VC/VS]

```
int main(int argc, char* argv[])
{
    if(argc < 3)
    {
        printf("usage: ReadMemory [ address ] [ dwLength ] [ mem_type ]\n\n");
        printf("where\n");
        printf("    address:\n");
        printf("        - the memory address where read from.\n");
        printf("    dwLength:\n");
        printf("        - number of characters to be read.\n");
        printf("    mem_type:\n");
        printf("        - 0   SRAM\n");
        printf("        - 1   EEPROM\n");
    }
    else
    {
        BYTE buffer[4096];
        BOOL err;
        char strErr[32];
        memset(buffer, 0, 4096);
        if(atoi(argv[3]) == 0)
        {
            printf("The size of SRAM is %d\n", pac_GetMemorySize(atoi(argv[3]]));
            err = pac_ReadMemory(atoi(argv[1]), buffer, atoi(argv[2]), atoi(argv[3]));
            if(err == FALSE)
            {
                pac_GetErrorMessage(pac_GetLastError(), strErr);
                printf("Read SRAM failure!. The error code is %x\n",
                pac_GetLastError());
                printf("%s", strErr);
                return 0;
            }
            printf("%s\n", buffer);
        }
    }
}
```

```

    }
    else
    {
        printf("The size of EEPROM is %d\n",
pac_GetMemorySize(atoi(argv[3]]));
        err = pac_ReadMemory(atoi(argv[1]), buffer, atoi(argv[2]), atoi(argv[3]));
        if(err == FALSE)
        {
            pac_GetErrorMessage(pac_GetLastError(), strErr);
            printf("Read EEPROM failure!. The error code is %x\n",
pac_GetLastError());
            printf("%s", strErr);
            return 0;
        }
        printf("%s\n", buffer);
    }
}
return 0;
}

```

[C#] for XP-8000 series only

```

class Program
{
static void Main(string[] args)
    {
        if (args.Length < 3)
        {
            Console.WriteLine("pac_WriteDO for 8000 modules\n\n");
            Console.WriteLine("usage: pac_WriteDO [ Slot ] [ total channel ]
[ DO's value ]\n\n");
            Console.WriteLine("where\n");
            Console.WriteLine("Slot:\n");
            Console.WriteLine(" - number of slot for local modules\n");
            Console.WriteLine("total channel:\n");
            Console.WriteLine(" - number of DO's channel\n");
            Console.WriteLine("DO's value:\n");
            Console.WriteLine(" - 1 is to turn on the DO channel; 0 is off.\n");
        }
        else
        {
            bool err;
            err = XPac.pac_WriteDO(IntPtr.Zero, Convert.ToInt32(args[1]),
                Convert.ToInt32(args[2]), Convert.ToUInt32(args[3]));
            if (err == false)
            {
                Console.WriteLine("Write DO's Error: " +
XPac.pac_GetErrorMessage(XPac.pac_GetLastError()) + ". The error code is " +
XPac.pac_GetLastError().ToString() + "\n");
                return;
            }
        }
    }
}

```

Remark

The `pac_GetErrorMessage` function can be used to obtain error message strings for the XPac error codes returned by `pac_GetLastError`, as shown in the following example.

9.4. pac_ClearLastError

This function clears the last-error code.

Syntax

C++

```
void pac_ClearLastError();
```

Parameter

None

Return Values

None

Examples

None

Remark

The `pac_ClearLastError` function clears the last error, that is, the application is treated as success.

Appendix A. MISC API

Supported Modules

The following shows the overview of the Misc functions which are available with XPAC.

Functions\Models	XP-8000 (WES)	XP-8000-CE6	XP-8000-Atom (WES)	XP-8000-Atom -CE6
AnsiString	Y	X	Y	X
WideString	Y	X	Y	X
pac_AnsiToWideString	X	Y	X	Y
pac_WideToAnsiString	X	Y	X	Y
pac_DoEvents	Y	Y	Y	Y

Function List

The following functions are used to retrieve or set backplane functions.

Function	Description
AnsiString	AnsiString
WideString	WideString
pac_AnsiToWideString	This function can convert ansi string to Unicode string.
pac_WideToAnsiString	This function can convert unicode string to ansi string.
pac_DoEvents	This function returns control to your system.

A1. AnsiString (for XP-8000 series only)

This function can convert unicode string to ansi byte array.

Syntax

C#

```
byte[] AnsiString(  
    [in] string str  
);
```

Parameter

str

[in] A pointer to a buffer that stores unicode string.

Return Values

Return ansi byte array.

Examples

[C#]

```
byte[] result = new byte[32];  
IntPtr hPort = XPac.uart_Open("COM1,115200,N,8,1");  
XPac.pac_ChangeSlot(Convert.ToByte(1));  
XPac.uart_SendCmd(hPort, XPac.AnsiString("$00M"), result);  
string str = XPac.WideString(result);
```

Remark

In .NET, if we want to convert a Unicode string to ANSI or vice versa, we should convert through byte array.

A2. WideString (for XP-8000 series only)

This function can convert ansi byte array to unicode string.

Syntax

C#

```
string WideString(  
    byte[] CharStr  
);
```

Parameter

CharStr

[in] A pointer to a buffer that stores ansi byte array.

Return Values

Return unicode string.

Examples

[C#]

```
byte[] result = new byte[32];  
IntPtr hPort = XPac.uart_Open("COM1,115200,N,8,1");  
XPac.pac_ChangeSlot(Convert.ToByte(1));  
XPac.uart_SendCmd(hPort, XPac.AnsiString("$00M"), result);  
string str = XPac.WideString(result);
```

Remark

In .NET, if we want to convert a Unicode string to ANSI or vice versa, we should convert through byte array.

A3. `pac_AnsiToWideString` (for XPAC_CE series only)

This function can convert ansi string to Unicode string.

Syntax

C++

```
void pac_AnsiToWideString(  
    LPCSTR astr,  
    LPTSTR wstr  
);
```

Parameter

astr

[in] A pointer to a buffer that stores ansi string.

wstr

[in] A pointer to a buffer that receives unicode string.

Return Values

None.

Examples

[VS]

```
char astr[128] = "This is an ansi string"  
TCHAR wstr[128];  
pac_AnsiToWideString(astr, wstr);
```

A4. `pac_WideToAnsiString` (for XPAC_CE series only)

This function can convert unicode string to ansi string.

Syntax

C++

```
void pac_WideToAnsiString(  
    LPCTSTR wstr,  
    LPSTR astr  
);
```

Parameter

wstr

[in] A pointer to a buffer that stores unicode string.

astr

[in] A pointer to a buffer that receives ansi string.

Return Values

None.

Examples

[VS]

```
TCHAR wstr[128] = TEXT("This is a Unicode string");  
char astr[128];  
pac_WideToAnsiString(wstr, astr);
```

A5. pac_DoEvents

When you run a Windows Form, it creates the new form, which then waits for events to handle. Each time the form handles an event, it processes all the code associated with that event. All other events wait in the queue. While your code handles the event, your application does not respond. If you call `pac_DoEvents` in your code, your application can handle the other events.

This function returns control to your system.

Syntax

C++

```
void pac_DoEvents();
```

Parameter

None

Return Values

None

Examples

[VC/VS]

```
int counter = 0;
char buf[10];
bFlag = true;
while(bFlag)
{
    pac_DoEvents();
    sprintf(buf, "%d", counter);
    SetDlgItemText(IDC_EDIT1, buf);
    counter++;
}
```

Appendix B. System Error Codes

This following table provides a list of system error code. There are turned by the `pac_GetLastError` function when many functions fail. To retrieve the description text for the error in your application, use the `pac_GetErrorMessage` function.

Error Code	Error Message
0x00001	Unknow Error
0x10001	Slot registered error
0x10002	Slot not registered error
0x10003	Unknown Module
0x10004	Module doesn't exist
0x11001	EEPROM accesses invalid address
0x11002	SRAM accesses invalid address
0x11003	SRAM accesses invalid type
0x12001	The input value is invalid
0x12002	The wdt doesn't exist
0x12003	The wdt init error
0x13001	Create interrupt's event failure
0x14001	Uart check sum error
0x14002	Uart read timeout
0x14003	Uart response error
0x14004	Uart under input range
0x14005	Uart exceed input range
0x14006	Uart open filed
0x14007	Uart get Comm Modem status error
0x14008	Uart get wrong line status
0x15001	IO card does not support this API function
0x15002	API unsupport this IO card
0x15003	Slot's value exceeds its range
0x15004	Channel's value exceeds its range
0x15005	Gain's value exceeds its range
0x15006	Unsupported interrupt mode
0x15007	I/O value is out of the range
0x15008	I/O channel is out of the range

Appendix C. API Comparison

The following tables give a brief summary of the capabilities of each API function, where Y means supported and X means unsupported

System Information API

Functions\Models	XP-8000 (WES)	XP-8000-CE6	XP-8000-Atom (WES)	XP-8000-Atom -CE6
pac_GetModuleName	Y	Y	Y	Y
pac_GetRotaryID	Y	Y	Y	Y
pac_GetSerialNumber	Y	Y	Y	Y
pac_GetSDKVersion	Y	Y	Y	Y
pac_ChangeSlot	Y	Y	Y	Y
pac_CheckSDKVersion	Y	Y	Y	Y
pac_ModuleExists	Y	Y	Y	Y
pac_GetOSVersion	X	Y	X	Y
pac_GetMacAddress	X	Y	X	Y
pac_ReBoot	X	Y	X	Y
Pac_GetCPUVersion	Y	Y	Y	Y
Pac_EnableLED	X	X	Y	Y

Backplane Access API

Functions\Models	XP-8000 (WES)	XP-8000-CE6	XP-8000-Atom (WES)	XP-8000-Atom -CE6
pac_GetDIPSwitch	Y	Y	Y	Y
pac_GetSlotCount	Y	Y	Y	Y
pac_EnableRetrigger	Y	Y	Y	Y
pac_GetBackplaneID	Y	Y	Y	Y
pac_GetBatteryLevel	Y	Y	Y	Y

Interrupt API

Functions\Models	XP-8000 (WES)	XP-8000-CE6	XP-8000-Atom (WES)	XP-8000-Atom -CE6
pac_RegisterSlotInterrupt	Y	Y	Y	Y
pac_UnregisterSlotInterrupt	Y	Y	Y	Y
pac_EnableSlotInterrupt	Y	Y	Y	Y
pac_SetSlotInterruptPriority	Y	Y	Y	Y
pac_InterruptInitialize	Y	Y	Y	Y
pac_GetSlotInterruptEvent	Y	Y	Y	Y
pac_SetSlotInterruptEvent	Y	Y	Y	Y
pac_SetTriggerType	Y	Y	Y	Y
pac_GetSlotInterruptID	Y	Y	Y	Y
pac_InterruptDone	Y	Y	Y	Y

Memory Access API

Functions\Models	XP-8000 (WES)	XP-8000-CE6	XP-8000-Atom (WES)	XP-8000-Atom -CE6
pac_GetMemorySize	Y	Y	Y	Y
pac_ReadMemory	Y	Y	Y	Y
pac_WriteMemory	Y	Y	Y	Y
pac_EnableEEPROM	Y	Y	Y	Y

Watchdog API

Functions\Models	XP-8000 (WES)	XP-8000-CE6	XP-8000-Atom (WES)	XP-8000-Atom -CE6
pac_EnableWatchDog	Y	Y	Y	Y
pac_DisableWatchDog	Y	Y	Y	Y
pac_RefreshWatchDog	Y	Y	Y	Y
pac_GetWatchDogState	Y	Y	Y	Y
pac_GetWatchDogTime	Y	Y	Y	Y
pac_SetWatchDogTime	Y	Y	Y	Y

Uart API

Functions\Models	XP-8000 (WES)	XP-8000-CE6	XP-8000-Atom (WES)	XP-8000-Atom -CE6
uart_Open	Y	Y	Y	Y
uart_Close	Y	Y	Y	Y
uart_Send	Y	Y	Y	Y
uart_Recv	Y	Y	Y	Y
uart_SendCmd	Y	Y	Y	Y
uart_SetTimeOut	Y	Y	Y	Y
uart_EnableChecksum	Y	Y	Y	Y
uart_SetTerminator	Y	Y	Y	Y
Uart_BinSend	Y	Y	Y	Y
Uart_BinRecv	Y	Y	Y	Y
Uart_BinSendCmd	Y	Y	Y	Y
Uart_GetLineStatus	Y	Y	Y	Y
Uart_GetDataSize	Y	Y	Y	Y

PAC_IO API

Functions\Models	XP-8000 (WES)	XP-8000-CE6	XP-8000-Atom (WES)	XP-8000-Atom -CE6
pac_GetBit	Y	Y	Y	Y
pac_WriteDO	Y	Y	Y	Y
pac_WriteDOBit	Y	Y	Y	Y
pac_ReadDO	Y	Y	Y	Y
pac_ReadDI	Y	Y	Y	Y
pac_ReadDIO	Y	Y	Y	Y
pac_ReadDILatch	Y	Y	Y	Y
pac_ClearDILatch	Y	Y	Y	Y
pac_ReadDIOLatch	Y	Y	Y	Y
pac_ClearDIOLatch	Y	Y	Y	Y
pac_ReadDICNT	Y	Y	Y	Y
pac_ClearDICNT	Y	Y	Y	Y
pac_WriteAO	Y	Y	Y	Y
pac_ReadAO	Y	Y	Y	Y
pac_ReadAI	Y	Y	Y	Y
pac_ReadAIHex	Y	Y	Y	Y
pac_ReadAIAll	Y	Y	Y	Y
pac_ReadAIAllHex	Y	Y	Y	Y
pac_ReadCNT	Y	Y	Y	Y
pac_ClearCNT	Y	Y	Y	Y
pac_ReadCNTOverflow	Y	Y	Y	Y

Backplanet API

Functions\Models	XP-8000 (WES)	XP-8000-CE6	XP-8000-Atom (WES)	XP-8000-Atom -CE6
pac_GetBPTimerTimeTick_ms	N	Y	N	N
pac_GetBPTimerTimeTick_us	N	Y	N	N
pac_KillBPTimer	N	Y	N	N
pac_SetBPTimer	N	Y	N	N
pac_SetBPTimerOut	N	Y	N	N
pac_SetBPTimerInterruptPriority	N	Y	N	N

Error Handling API

Functions\Models	XP-8000 (WES)	XP-8000-CE6	XP-8000-Atom (WES)	XP-8000-Atom -CE6
pac_GetLastError	Y	Y	Y	Y
pac_SetLastError	Y	Y	Y	Y
pac_GetErrorMessage	Y	Y	Y	Y
pac_ClearLastError	Y	Y	Y	Y

MISC API

Functions\Models	XP-8000 (WES)	XP-8000-CE6	XP-8000-Atom (WES)	XP-8000-Atom -CE6
AnsiString	Y	X	Y	X
WideString	Y	X	Y	X
pac_AnsiToWideString	X	Y	X	Y
pac_WideToAnsiString	X	Y	X	Y
pac_DoEvents	Y	Y	Y	Y