



IOP760/IOP760-EU

Ethernet/UART to Wi-Fi Converter

Features

- Support Wi-Fi dual bands 2.4/5 GHz
- Compatible with IEEE 802.11 a/b/g/n/ac standard
- Support different connection modes: AP, WDS and AP Clients
- Wi-Fi/Ethernet/RS-232/RS-485 bridge
- Wi-Fi roaming
- Modbus RTU to Modbus TCP gateway
- Support CLI (Command Line Interface) interface
- Website Configuration Interface



Introduction

IOP760 is a wireless converter. The data can be exchanged via the three different interfaces Wi-Fi, Ethernet and UART. The Wi-Fi interface supports IEEE 802.11 a/b/g/n/ac standard. Users can select IEEE 802.11 b/g/n for 2.4GHz connections or select IEEE 802.11 a/n/ac for 5GHz connections. When the Wi-Fi strength is lower than the threshold setting, IOP760 can connect to another stronger one via the roaming function. The IOP760 has two Ethernet interfaces that can connect to two Ethernet devices. All the Ethernet devices exchange data via the IOP760. In the UART communication, data can be sent directly or formed by Modbus protocol.

System Specifications

Model	IOP760	IOP760-EU
Wi-Fi Interface		
Standard	IEEE 802.11a/b/g/n/ac	
Security	WEP / WPA / WPA2 / WPA-PSK / WPA2-PSK	
Client	Max. 10 Clients (AP mode)	
Data Rate	2.4 GHz	300 Mbps(MIMO 2T2R)
	5 GHz	866 Mbps(MIMO 2T2R)
Channel	2.4 GHz	1~11
	5 GHz	36/40/44/48 149/153/157/161/165
Transmission Range	50 meters (LOS)	
Antenna	5 dBi 2.4/5 GHz	
Ethernet Interface		
Ethernet	2 × RJ45 FE	
UART Interface		
Interface	1 × RJ12 (RS-232/RS-485)	
Baud rate	RS-232	9600 / 19200 / 38400 / 57600 / 115200
	RS-485	9600 / 19200 / 38400 / 57600 / 115200 / 230400 / 460800
Data Bits	8 / 7	
Stop Bits	1 / 2	

Model	IOP760	IOP760-EU
Power		
Power Input	+9 ~ 36 VDC	
Mechanical		
Mounting	DIN-Rail	
Dimensions (W x L x H)	31 mm × 99 mm × 131mm (without Mounting kit)	
	31 mm × 108 mm × 131mm (with DIN Rail kit)	
	167 mm × 99 mm × 39mm (with Bracket kit)	
Environment		
Operating Temperature	-30 ~ +70°C	
Storage Temperature	-40 ~ +80°C	
Humidity	10 ~ 95% RH, Non-condensing	
Plug Type		
Picture		

Applications

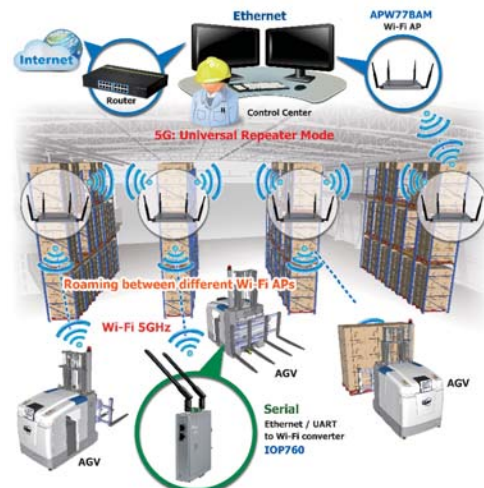
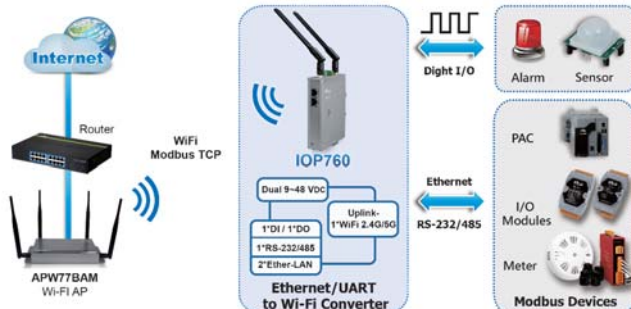

Antenna Field

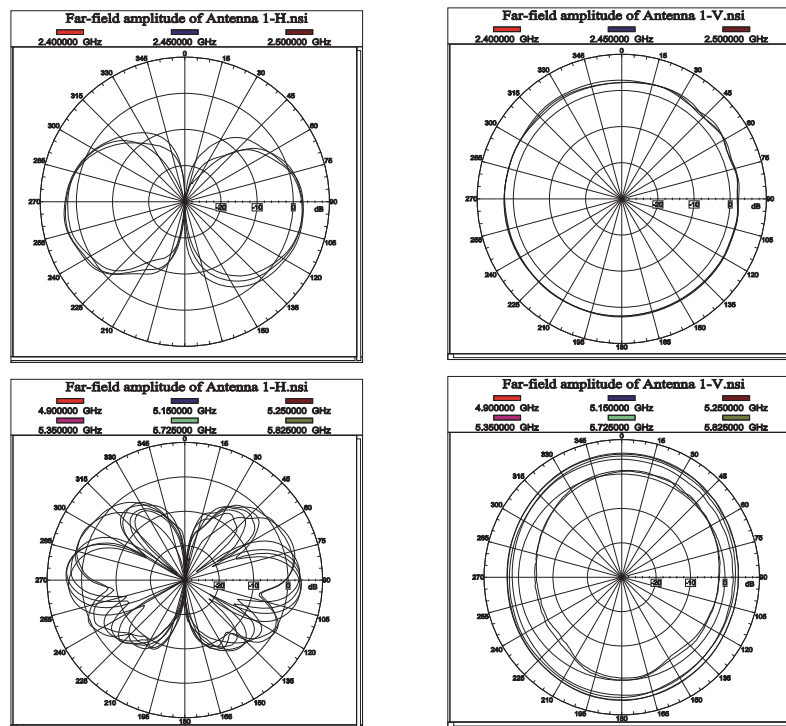



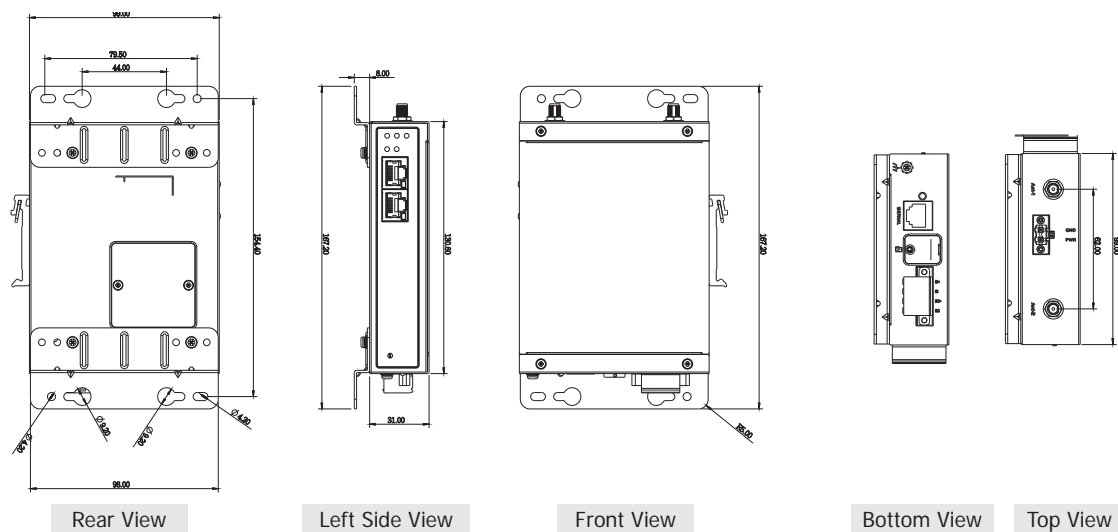

Dimensions (Units: mm)



Ordering Information

IOP760 CR	Ethernet/UART to Wi-Fi Converter (with category A plug type)
IOP760-EU CR	Ethernet/UART to Wi-Fi Converter (with category E plug type)

Accessories

3S001-1		RG58A/U 1 Meter Long RP-SMA male to RP-SMA Female
3S003-1		RG58A/U 3 Meter Long RP-SMA male to RP-SMA Female
3S005-1		RG58A/U 5 Meter Long RP-SMA male to RP-SMA Female
3S008-1		RG58A/U 8 Meter Long RP-SMA male to RP-SMA Female