

DL-301-WF/DL-302-WF/DL-303-WF/DL-307-WF



CO/CO2/HCHO/Temperature/Humidity/
Dew Point Data Logger

Features

- Simultaneous Display for CO, CO2, Temperature, Humidity and Dew Point
- Non-dispersive Infrared (NDIR) CO2 Sensor
- 2.8" LCD Touch Screen
- Able to store up to 450,000 records with date and time stamps
- Touch-screen and Web-based Configuration Interface
- Simple and Powerful Software Utility, iOS APP and Android App Included
- Able to Display Multilingual Messages on the Screen
- Supports the DCON, Modbus RTU, Modbus TCP and MQTT Protocols
- Includes RS-485/Ethernet/Wi-Fi Communication Interfaces
- Compatible with IEEE802.11b/g/n standards
- Support infrastructure and limit-AP modes for wireless networks
- Relay Output for Audible/Visual Alarm or IAQ Device Control
- Includes redundant power inputs: PoE (IEEE 802.3af, Class 1) and DC input
- Desktop, DIN-Rail or Wall Mounting



Introduction

The DL-300-WF series is an IAQ(Indoor Air Quality) monitoring module with Wi-Fi, Ethernet and RS-485 interfaces. It provides a WLAN connection which complies with the IEEE802.11b/g/n standards. With the popularity of 802.11 network infrastructure, the modules make an easy way to incorporate wireless connectivity into monitoring and control systems. The DL-300-WF series of data logger devices can be used to record CO, CO2, temperature, humidity and dew point information, including date and time stamps, and are able to store up to 450,000 downloadable records.

Real-time data can be accessed from the DL-300-WF data logger from anywhere and at any time using the free Windows software, the iOS App or the Android App, as long as they are connected to the same local network as the data logger. Support is provided for popular industrial protocols such as DCON, Modbus RTU, and Modbus TCP, as well as the emerging machine-to-machine (M2M)/IoT (Internet of Things) connectivity protocol – MQTT. The DL-300-WF Data Logger can be connected via widely used communication interfaces including RS-485, Ethernet and PoE, meaning that the device can be easily integrated into existing HMI or SCADA systems, and is easy to be maintained in a distributed control system.

Large 2.8" LCD Touch Screen, with clear Color Chart to indicate the CO/CO2 Level

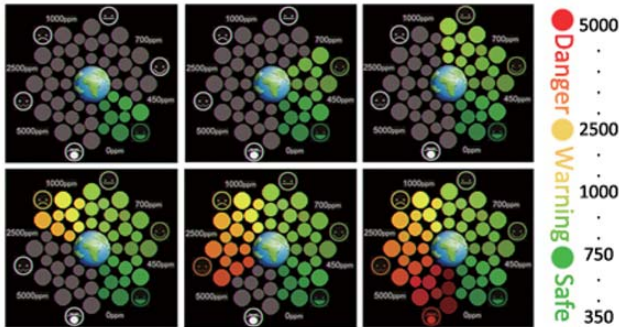

Multi-platform Remote Access Software

Real-time data from the DL-300 Data Logger can be accessed from anywhere and at any time using the DL300 Utility, the iOS or Android App, or via a regular web browser, as long as they are connected to the same local network as the Data Logger.



Simple and Powerful DL-300 Utility

The DL300 Utility can be used to configure the modules, monitor real-time data, group DL-300 modules so that the status of distribution groups can be viewed and managed. The utility also allows the log data to be downloaded and exported to a .CSV file that can then be imported into any industry-standard software or spread sheet for analysis.

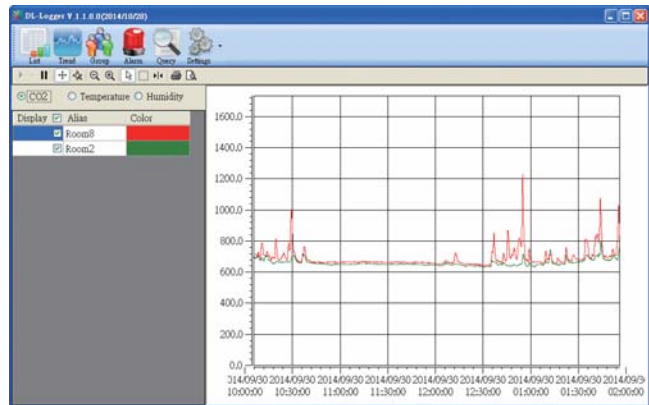

Supports the MQTT Protocol for IoT Applications (Ethernet Interface Only)

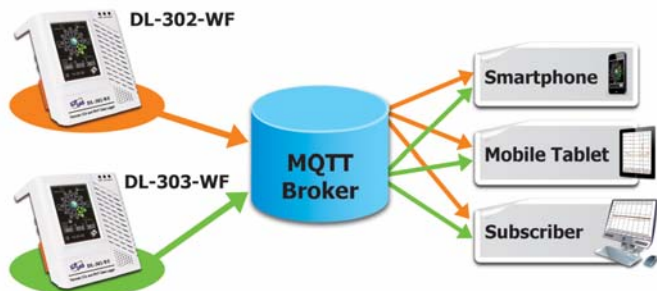

➔ Real-time data from the DL-300-WF series can be accessed from anywhere and at any time using the WF-IIOT-Utility and iOS App.



▲ iOS APP QR CODE



▲ Android APP QR CODE

➔ Display Messages in Multiple Languages

The display-message-on-screen function supports multiple language character sets based on UTF-8 encoding. Either pre-configured messages or dynamic messages can be remotely displayed using Modbus commands, or a dynamic message can be sent via the web-based interface.

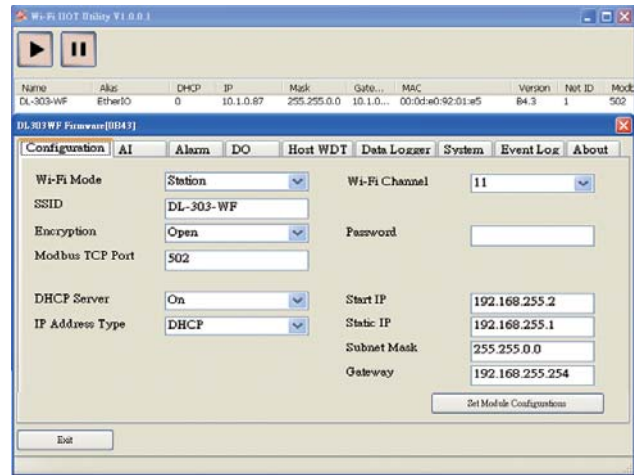

▲ WiFi-IIOT-Utility

Applications

- Transportation of Food or Pharmaceuticals
- Food and Beverage Industry (HACCP)
- Blood Stations and Pharmacies
- Building and Energy Management
- Warehouse Management
- Museums, Archives and Galleries



Pin Assignments & Wire Connections

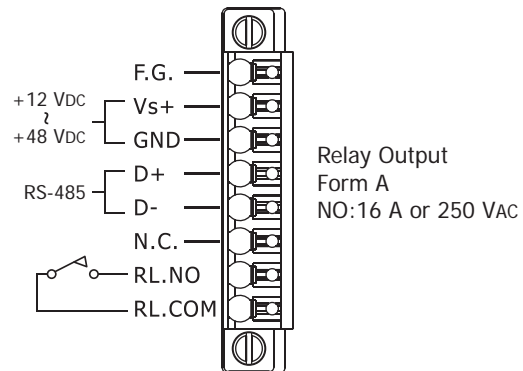
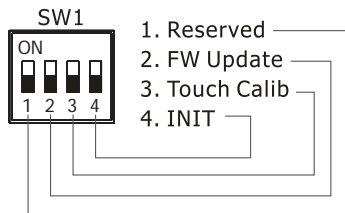

Appearance

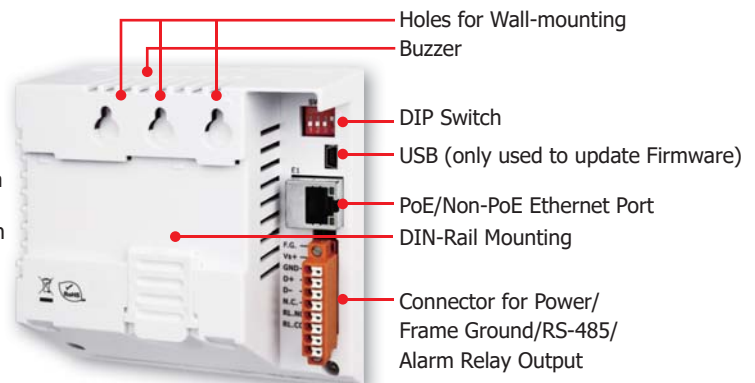
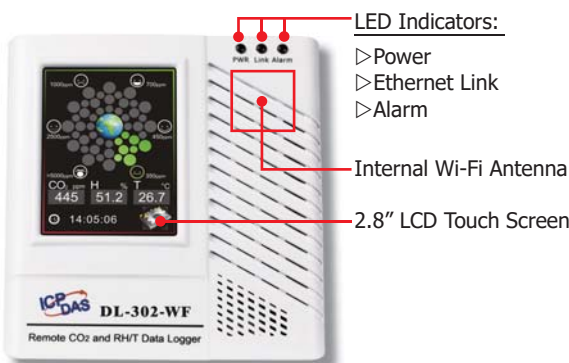

Specifications

Model	DL-301-WF	DL-302-WF	DL-303-WF	DL-307-WF
HCHO Measurement				
Range		-		0 ppb to 2000 ppb (Electrochemical)
Resolution		-		1 ppb
Accuracy		-		0 ~ 300ppb : ±30ppb > 300ppb : ±10%
Response Time		-		≤60 seconds
Warm-up Time		-		180 seconds
TVOC Measurement				
Range		-		0 ppb to 60000 ppb (MEMS Metal Oxide)
Resolution		-		1 ppb
Accuracy		-		±15%
Response Time		-		60 seconds
Warm-up Time		-		180 seconds
CO Measurement				
Range	0 to 1000 ppm (Electrochemical)	-	0 to 1000 ppm (Electrochemical)	-
Resolution	1 ppm	-	1 ppm	-
Accuracy	±5% of measured value	-	±5% of measured value	-
Response Time	30 seconds	-	30 seconds	-
Warm-up Time	300 seconds	-	300 seconds	-
CO2 Measurement				
Range	-	0 to 9999 ppm (NDIR)		-
Resolution	-	1 ppm		-
Accuracy	-	±40 ppm ±3% of measured value		-
Response Time	-	120 seconds		-
Warm-up Time	-	60 seconds		-
Temperature Measurement				
Range		-10 to +50°C		
Resolution		0.1°C		
Accuracy		±0.6°C		
Relative Humidity Measurement				
Range		0 to 100% RH, Non-condensating		
Resolution		0.1% RH, Non-condensing		
Accuracy		±5% RH, Non-condensing		
Dew Point				
Range		Calculated using temperature and relative humidity		
Resolution		0.1°C		
System				
CO Alarm	Yes	-	Yes	-
CO2 Alarm	-	Yes	Yes	-
Real-time Clock		Yes		
Data Logger		Yes, 450,000 Records		
Alarm Relay Output		Form A×1, SPST. 30 VDC @ 16 A or 250 VAC @ 16 A		
Software				
Built-in Web Server		Yes		
Communication				
RS-485 Port		Baud Rate = 1200 ~ 115200 bps		
Ethernet Port		10/100 Base-TX, 8-Pin RJ-45 x1 (Auto-negotiating, Auto-MDI/MDIX, LED indicators)		
Security		IP filter (whitelist) and Password (web)		
Protocol		ModbusRTU(RS-485), Modbus TCP(Ethernet/Wi-Fi) and MQTT(Ethernet)		
Dual Watchdog		Yes, Module (2.3 seconds), Communication (Programmable)		
Wi-Fi Interface				
Antenna		Antenna = 1 dBi (PCB Antenna)		
Output Power		18 dBm @ 1 DSSS, 14.5 dBm @ 54 OFDM		
Receive Sensitivity		-95.7 dBm @ 1 DSSS, -74.0 dBm @ 54 OFDM		
Standard Supported		IEEE 802.11 b/g/n		
Wireless Mode		Infrastructure & Limited AP		
Encryption		WEP, WPA and WPA2		
Transmission Range		50 meters (LOS)		
Electrical				
Powered from Terminal Block		+12 to +48 VDC		
Powered from PoE		IEEE 802.3af, Class 1 (48 V)		
Power Consumption	PoE	1.8 W (Max.)	1.8 W (Max.)	1.9 W (Max.)
	Non-PoE	1.7 W (Max.)	1.7 W (Max.)	1.8 W (Max.)
Mechanical				
Dimensions (L x W x H)		114 mm x 106 mm x 56 mm		
Installation		Desktop, DIN-Rail or Wall Mounting		
Environment				
Operating Temperature		0 to +50°C		
Storage Temperature		-30 to +75°C		
Humidity		10 to 90% RH, Non-condensing		



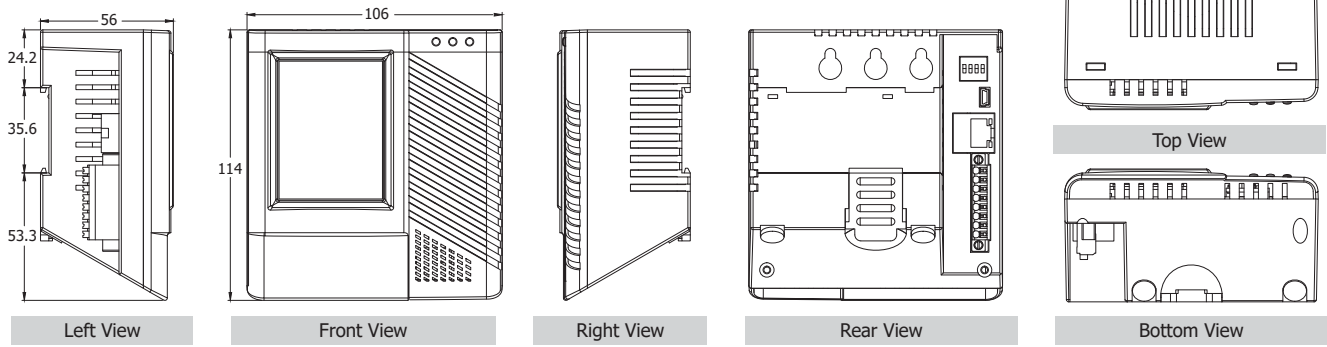





■ Dimensions (Units: mm)



■ Ordering Information

DL-301-WF CR	Remote CO/Temperature/Humidity/Dew Point Data Logger with Ethernet/RS-485/Wi-Fi Interfaces and PoE (RoHS)
DL-302-WF CR	Remote CO ₂ /Temperature/Humidity/Dew Point Data Logger with Ethernet/RS-485/Wi-Fi Interfaces and PoE (RoHS)
DL-303-WF CR	Remote CO/CO ₂ /Temperature/Humidity/Dew Point Data Logger with Ethernet/RS-485/Wi-Fi Interfaces and PoE (RoHS)
DL-307-WF CR	Remote HCHO/TVOC/Temperature/Humidity/Dew Point Data Logger with Ethernet/RS-485/Wi-Fi Interfaces and PoE (RoHS)

■ Accessories

	NS-205 CR	Unmanaged 5-port Industrial Ethernet Switch. 24 Vdc Input (RoHS)
	NS-205PSE CR	Unmanaged Ethernet switch with 4-PoE and 1 RJ45 uplink connectors. 48 Vdc Input (RoHS)
	NS-205PSE-24V CR	Unmanaged Ethernet switch with 4-PoE and 1 RJ45 uplink connectors. 24 Vdc Input (RoHS)
	MDR-20-24 CR	24V/1A, 24 W Power Supply with DIN-Rail Mounting (RoHS)
	MDR-60-48 CR	48V/1.25A, 60 W Single Output Industrial DIN Rail Power Supply (RoHS)
	tM-7561 CR	USB to Isolated RS-485 Converter (RoHS)
		Ethernet/UART to Wi-Fi Converter(RoHS)
	APW77BAM	Wi-Fi Access Point (with category A plug type) (RoHS)