



# CL-213

# User Manual



## **Warranty**

All products manufactured by ICP DAS are under warranty regarding defective materials for a period of one year, beginning from the date of delivery to the original purchaser.

## **Warning**

ICP DAS assumes no liability for any damage resulting from the use of this product. ICP DAS reserves the right to change this manual at any time without notice. The information furnished by ICP DAS is believed to be accurate and reliable. However, no responsibility is assumed by ICP DAS for its use, nor for any infringements of patents or other rights of third parties resulting from its use.

## **Copyright**

Copyright © 2016 ICP DAS Co., Ltd. All rights are reserved.

## **Trademarks**

Names are used for identification purposes only and may be registered trademarks of their respective companies.

Date: 2016/10



## Table of Contents

1.	Hardware Information.....	4
1.1.	Introduction.....	4
1.2.	Specifications.....	5
1.3.	Pin Assignments.....	7
1.4.	Wiring Connections .....	7
1.5.	DIP Switch Configuration .....	8
1.6.	Package Contents .....	9
1.7.	Hardware Overview.....	10
1.8.	Hardware Installation .....	11
2.	DCON Protocol.....	13
2.1.	DCON Command Sets for the CL-213 Module .....	14
3.	Modbus RTU Protocol.....	20
3.1	Modbus Address Mapping(Base 1) .....	21



## **1. Hardware Information**

### **1.1. Introduction**

The CL-213 is a data logger module designed to accurately measure PM2.5, CO, CO2, temperature and humidity. It contains RS-485 communication interface that can be used to measure a variety of PM2.5, CO, CO2, temperature and humidity measurements. The data storage memory can store up to 450,000 PM2.5, CO, CO2, temperature and humidity records. The Data Logger Utility is included to allow installation, configuration, retrieval and display of data in a powerful chart format that can be exported to Excel.



## 1.2. Specifications

<b>Model</b>	CL-213
<b>PM2.5 Measurement</b>	
Range	0 to 400 ug/m <sup>3</sup>
Resolution	1 ug/m <sup>3</sup>
Response Time	<= 1min.
<b>CO Measurement</b>	
Range	0 to 1000 ppm (Electrochemical)
Resolution	1ppm
Accuracy	±5% of measured value
Response Time	30 seconds
Warm-up Time	60 seconds
<b>CO2 Measurement</b>	
Range	0 to 9999 ppm (NDIR)
Resolution	1 ppm
Accuracy	±40 ppm ±3% of measured value
Response Time	120 seconds
Warm-up Time	5 minutes
<b>Temperature Measurement</b>	
Range	-10 to +50 °C
Resolution	0.1 °C
Accuracy	±0.6 °C
<b>Relative Humidity Measurement</b>	
Range	0 to 100% RH
Resolution	0.1% RH
Accuracy	±5% RH
<b>Dew Point</b>	
Range	Calculated using temperature and relative humidity
Resolution	0.1 °C
<b>System</b>	
PM2.5/CO2/RH/T Alarm	Yes
Real Time Clock	Yes
Data Logger	Yes, up to 450,000 records
Relay Output	Form C x 1, 30 VDC @ 16 A or 250 VAC @ 16A
Interface	RS-485
<b>Electrical</b>	



Powerd from Terminal Block	+10 to +30 VDC
Power Consumption	1.2 W(Max.)
<b>Mechanical</b>	
Installation	Ceiling mounting
Protection Class	IP20
Dimensions (D x H)	Ø 150 mm x 53 mm
<b>Environment</b>	
Operating Temp.	0 to +50 °C
Storage Temp.	-30 to +80 °C
Humidity	10 to 90% RH, non-condensing

### 1.3. Pin Assignments

CL-213	Pin	Descriptions
	<b>+VS</b>	Power Input (+10 ~ +30 VDC)
	<b>GND</b>	Ground
	<b>D+</b>	RS-485 Serial Communication Interface
	<b>D-</b>	
	<b>N.C</b>	Relay's Normally Closed Contact
	<b>N.O</b>	Relay's Normally Open Contact
	<b>COM</b>	Relay's Common Contact

### 1.4. Wiring Connections

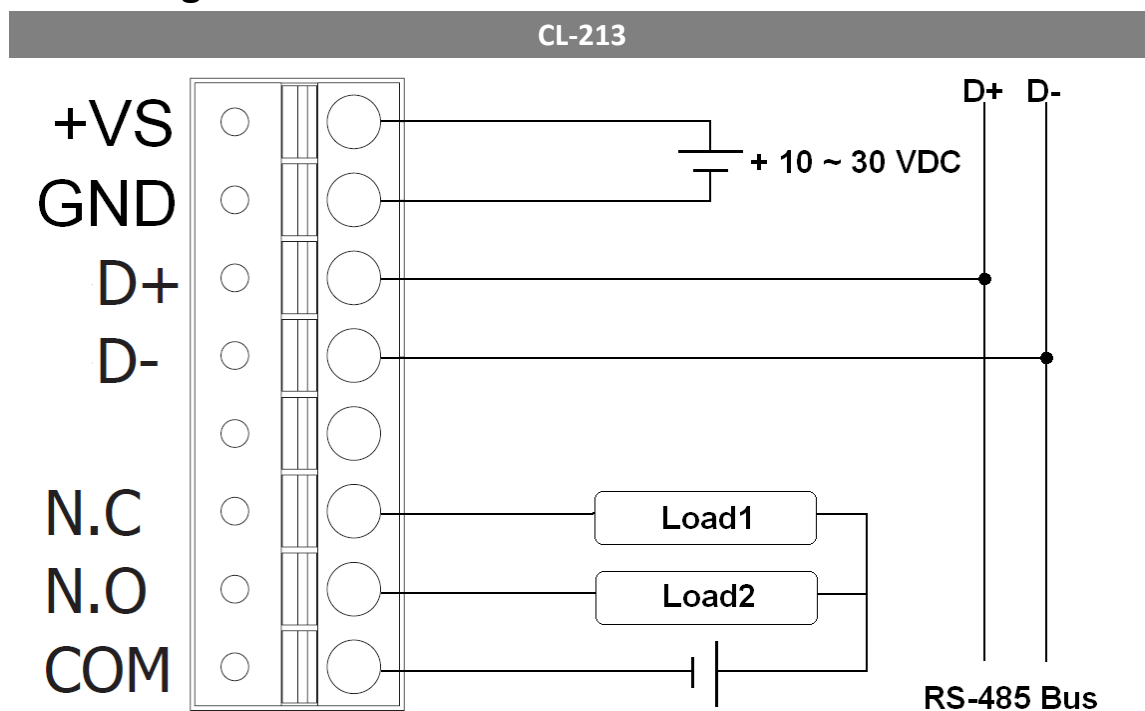

## 1.5. DIP Switch Configuration

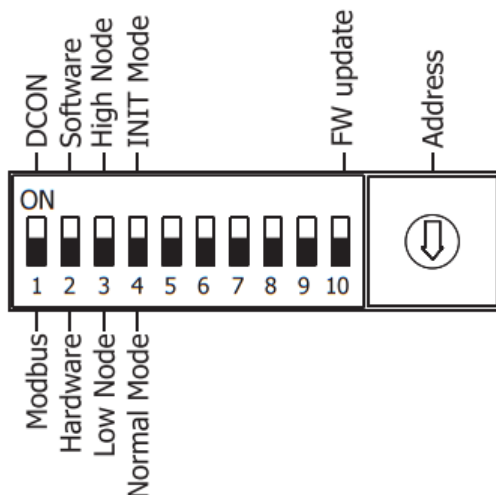

DIP [1]	<p><b>Protocol:</b></p> <p>Used to specify the communication protocol to be used by the module</p> <p>ON: DCON</p> <p>OFF: Modbus RTU (default)</p>
DIP [2]	<p><b>Configuration:</b></p> <p>Used to specify the configuration settings for the module</p> <p>ON: Configure the module using DCON/Modbus commands</p> <p>OFF: Configure the module via DIP Switch (default)</p>
DIP [3]	<p><b>Address:</b></p> <p>Used to specify the module address when DIP [2] is set to OFF</p> <p>ON: Use Rotary Switch positions 0 to F for node addresses 208 to 223</p> <p>OFF: Use Rotary Switch positions 0 to F for node addresses 192 to 207 (default)</p>
DIP [4]	<p><b>Mode:</b></p> <p>Used to specify the Operating Mode</p> <p>ON: Operating in INIT mode</p> <p>OFF: Operating in Normal mode (default)</p>



## 1.6. Package Contents



CL-213

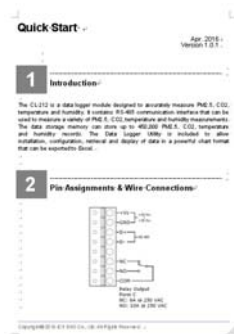

Quick Start Guide

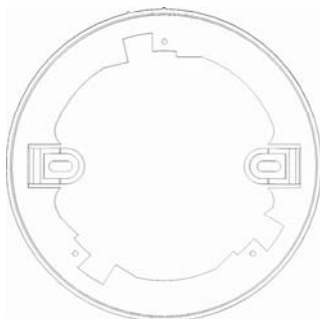

Mounting Plate

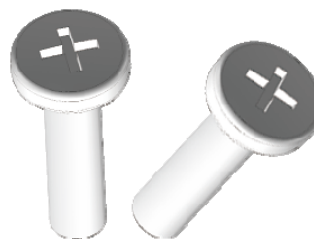

M4x12 Drywall Screws

## 1.7. Hardware Overview

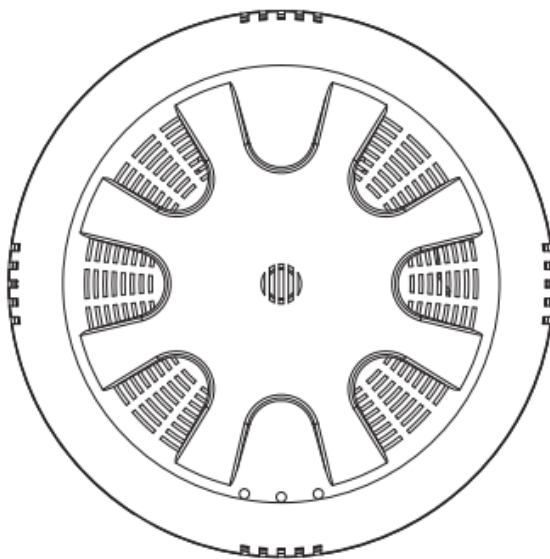

Front View

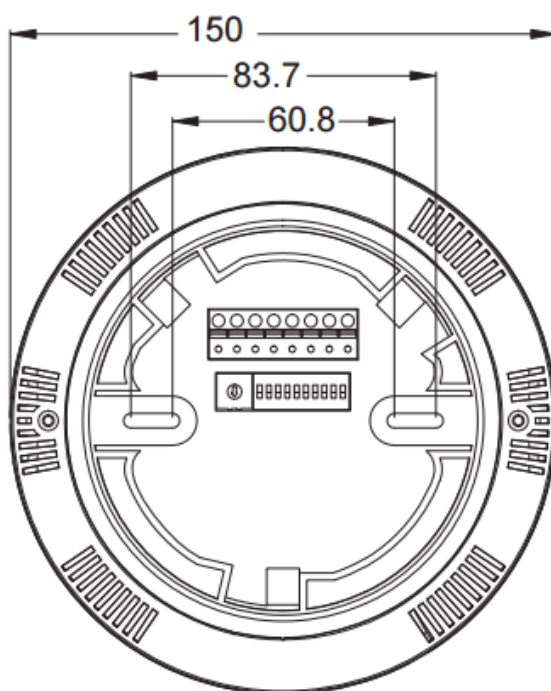

Rear View

## 1.8. Hardware Installation

### 1. Attach the mounting plate

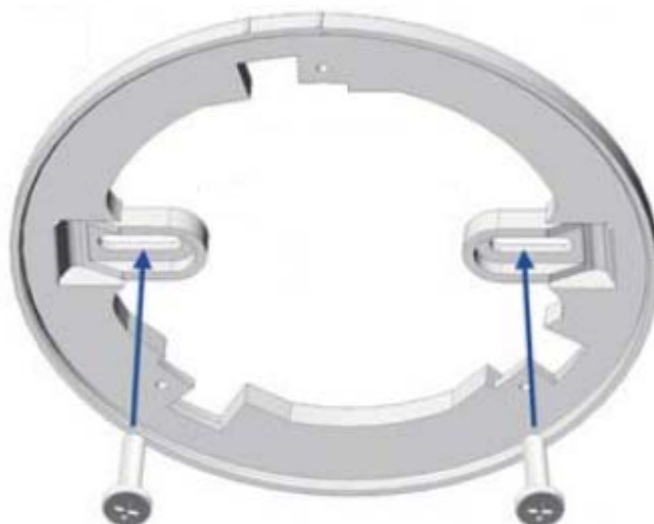

### 2. Align locking guides



3. Turn the cover clockwise



4. Lock the cover in place



## 2. DCON Protocol

All communication with the CL-213 module consists of commands generated by the Host and responses transmitted by the CL-213 module. Each module has a unique ID number that is used for addressing purposes and is stored in non-volatile memory. The module ID number is set to 01 by default and can be changed by sending a user command. All commands to the modules contain the ID number as the address, meaning that only the addressed module will respond.

### Command Format:

Delimiter Character	Module Address	Command	Checksum	CR
---------------------	----------------	---------	----------	----

### Response Format:

Delimiter Character	Module Address	Data	Checksum	CR
---------------------	----------------	------	----------	----

CR = End of command character, carriage return (0x0D), used to end a frame.

Note: All characters should be in upper case.

## 2.1. DCON Command Sets for the CL-213 Module

Command	Description
\$AAF	read firmware version
\$AAI	read INIT status response: !AA0 -> INIT short to GND !AA1 -> else
\$AAM	read module name
\$AAP	Read Modbus RTU/DCON protocol response: !AA0 -> DCON !AA1 -> Modbus RTU
\$AAPN	Set Modbus RTU/DCON protocol N-> 0: DCON, 1: Modbus RTU
\$AA2	read configuration
\$AA5	read reset status !AA1 first after power on, !AA0 others
#AA	Read All Analog Inputs response >(CO in 1 ppm) (CO2 in 1 ppm) (PM2.5 in 1 ug/m <sup>3</sup> ) (relative humidity in 0.01%)(temperature in 0.01°C)(temperature in 0.01°F) (dew point temperature in 0.01°C)(dew point temperature in 0.01°F)
#AAN	Read Channel Analog Input N = 0 for CO in 1 ppm, 1 for CO2 in 1 ppm ,2 for PM2.5 in 1 ug/m <sup>3</sup> , 3 for relative humidity in 0.01%, 4 for temperature in 0.01°C, 5 for temperature in 0.01°F, 6 for dew point temperature in 0.01°C, 7 for dew point temperature in 0.01°F
%AANNTTCFF	set configuration, NN: new address, TT = 00, CC: new baud rate FF: data format
@AABA	Read beep on alarm time response !AAHH, HH in hex, 0: disabled, 1 ~ 250: beep on alarm time in seconds, 251: beep on alarm continuously

Command	Description
@AABAHH	Set beep on alarm time HH in hex, 0: disabled, 1 ~ 250: beep on alarm time in seconds, 251: beep on alarm continuously
@AABE	Read enable/disable beep on alarm response !AAHH, HH in hex, bit 0 for channel 0, bit 1 for channel 1, etc, for each bit, 0: disabled, 1: enabled
@AABEHH	Enable/disable beep on alarm HH in hex, , bit 0 for channel 0, bit 1 for channel 1, etc, for each bit, 0: disabled, 1: enabled
@AACH	Clear all high latched analog inputs to the current values
@AACHN	Clear channel high latched analog input to the current value, N = 0 for CO1, 1 for CO2, 2 for PM2.5, 3 for relative humidity, 4 for temperature in 0.01°C, 5 for temperature in 0.01°F, 6 for dew point temperature in 0.01°C, 7 for dew point temperature in 0.01°F
@AACHCN	Clear high latched alarm of a channel, N = 0 for CO1, 1 for CO2, 2 for PM2.5, 3 for relative humidity, 4 for temperature in 0.01°C, 5 for temperature in 0.01°F, 6 for dew point temperature in 0.01°C, 7 for dew point temperature in 0.01°F
@AACL	Clear all low latched analog inputs to the current values
@AACLN	Clear channel low latched analog input to the current value, N = 0 for CO, 1 for PM2.5, 2 for relative humidity, 3 for temperature in 0.01°C, 4 for temperature in 0.01°F, 5 for dew point temperature in 0.01°C, 6 for dew point temperature in 0.01°F
@AACL CN	Clear low latched alarm of a channel, N = 3 for relative humidity, 4 for temperature in 0.01°C, 5 for temperature in 0.01°F, 6 for dew point temperature in 0.01°C, 7 for dew point temperature in 0.01°F
@AADACN	Disable AI alarm of a channel, N = 0 for CO, 1 for CO2, 2 for PM2.5, 3 for relative humidity, 4 for temperature in 0.01°C, 5 for temperature in 0.01°F, 6 for dew point temperature in 0.01°C, 7 for dew point temperature in 0.01°F

Command	Description
@AADI	read DO response !AA00000
@AADLB	Read the beginning of the period setting of the data logger for period logging mode response !AAyyyymmddhhmmss,
@AADLByyyyymmddhhmmss	Set the beginning of the period setting of the data logger for period logging mode yyyy: year, 2000 to 2199, mm: month, 01 to 12, dd: date, 01 to 31, hh: hour, 0 to 24, mm: minute, 0 to 59, ss: second, 0 to 59
@AADLC	Read the data logger command response !AAh, 0: stop, 1: run, 2: run in period mode
@AADLCh	Set the data logger command, h->0: stop, 1: run, 2: run in period mode
@AADLE	Read the ending of the period setting of the data logger for period logging mode response !AAyyyymmddhhmmss
@AADLEyyyymmddhhmmss	Set the ending of the period setting of the data logger for period logging mode yyyy: year, 2000 to 2199, mm: month, 01 to 12, dd: date, 01 to 31, hh: hour, 0 to 24, mm: minute, 0 to 59, ss: second, 0 to 59
@AADLN	Read number of log records in the data logger response !AAhhhhhhh, hhhhhhhh in hex format
@AADLO	Read the overwriting mode when data logger is full response !AAh, 0: stop logging when full, 1: overwrite
@AADLOh	Set the overwriting mode when data logger is full h->0: stop logging when full, 1: overwrite



Command	Description
@AADLP	Read the samplig period setting of the data logger response !AAhmmss, hh: hour, 0 to 24, mm: minute, 0 to 59, ss: second, 0 to 59
@AADLPhmmss	Set the samplig period setting of the data logger
@AADLS	Read logging status of the data logger response !AAhh, hh in hex format, 00: stopped, 01: running, others: error
@AAD00V	set DO, V-> 0: off, 1: on
@AAEATCN	Enable AI alarm of a channel, N = 0 for CO, 1 for PM2.5, 2 for relative humidity, 3 for temperature in 0.01°C, 4 for temperature in 0.01°F, 5 for dew point temperature in 0.01°C, 6 for dew point temperature in 0.01°F T->M: momentary alarm, L: latched alarm
@AAFN	Read fan status Response !AAE, E=0: fan off, 1: fan on,
@AAFNE	Turn fan on or off E=0: fan off, 1: fan on
@AAFNPi	Read the ith fan off period in a day, i = 0 to 5 response !AAbhbmehem, bh: beginning hour, bm: beginning minute, eh: ending hour, em: ending minute.
@AAFNPibhbmehe m	Set the ith fan off period in a day, i = 0 to 5, bh: beginning hour, 0 to 23, bm: beginning minute, 0 to 59, eh: ending hour, 0 to 23, em: ending minute, 0 to 59. The beginning hour/minute should be earlier than the ending hour/minute. Otherwise, the setting is ignored. If all of the six period settings are invalid, then the fan is controlled by the @AAFNE command.
@AAHI(data)CN	Set high alarm limit of an AI channel, N = 0 for CO in 1ppm, 1 for CO2 in 1ppm, 2 for PM2.5 in 1 ug/m3, 3 for relative humidity in 0.01%, 4 for temperature in 0.01°C, 5 for temperature in 0.01°F, 6 for dew point temperature in 0.01°C, 7 for dew point temperature in 0.01°F
@AAHO	Read humidity offset

Command	Description
@AAHO(data)	Set humidity offset, data in format of -100.00 ~ +100.00
@AALO(data)CN	Set low alarm limit of an AI channel, N = 3 for relative humidity in 0.01%, 4 for temperature in 0.01°C, 5 for temperature in 0.01°F, 6 for dew point temperature in 0.01°C, 7 for dew point temperature in 0.01°F
@AAPO	Read PM2.5 offset
@AAPO(data)	Set PM2.5 offset, data in format of -00100. ~ +00100.
@AARACN	Read AI alarm enabled/disabled status of a channel response !AAN, N->0: disabled, 1: momentary, 2: latched
@AARAO	Read AI alarm status response !AAHLL
@AARH	Read all high latched values of analog input channels
@AARHN	Read channel high latched value of analog input
@AARHCN	Read high alarm limit of an AI channel
@AARL	Read all low latched values of analog input channels
@AARLN	Read channel low latched value of analog input
@AARLCN	Read low alarm limit of an AI channel
@AART	Read RTC data response !AAYYYMMDDHHMMSS
@AARTYYYYMMD DHHMMSS	Set RTC data
@AATO	Read temperature offset in 0.01°C
@AATO(data)	Set temperature offset in 0.01°C, -100.00 ~ +100.00
~**	clear host watchdog timeout counter
~AA0	read host watchdog status
~AA1	clear host watchdog timeout status
~AA2	read host watchdog enable/disable status and timeout value
~AA3ETT	enable/disable host watchdog and set timeout value E-> 0: disable host watchdog, 1: enable host watchdog TT: host watchdog timeout in 0.1s in hex format
~AA4	read DO power on and safe value

Command	Description
~AA50P0S	set DO power on and safe value P-> 0: power on value off, 1: power on value on S-> 0: safe value off, 1: safe value on
~AARD	read response delay time in ms in hex format
~AARDVV	set response delay time in ms, VV in hex format, 00 - 1E

### Baud Rate Settings (CC)

7	6	5	4	3	2	1	0
Parity		Baud Rate Code					

### Parity (Bits 6 and 7)

Code	00	01	10	11
Parity	n,8,1	n,8,2	e,8,1	o,8,1

### Baud Rate Code (Bits 0 to 5)

Code	03	04	05	06	07	08	09	0A
Baud Rate	1200	2400	4800	9600	19200	38400	57600	115200

### Data Format Settings (FF)

7	6	5	4	3	2	1	0
Reserved	CS	Reserved					

Key	Description
CS	Checksum Settings 0: Disabled 1: Enabled

**Note:** All Reserved bits should be zero.

### 3. Modbus RTU Protocol

The Modbus protocol was originally developed for Modicon controllers by Modicon Inc. Detailed information related to the Modbus RTU protocol can be found at: <http://www2.schneider-electric.com/sites/corporate/en/products-services/automation-control/automation-control.page>. You can also visit <http://www.modbus.org> for more valuable information.

The CL-213 module supports the Modbus RTU protocol, with communication Baud Rates ranging from 1200 bps to 115200 bps. The parity, data bits and stop bits are fixed as no parity, 8 data bits and 1 stop bit. The following Modbus functions are supported.

Function Code	Description
0x01	Reads the Coils
0x02	Reads the Discrete Inputs
0x03	Reads Multiple Registers
0x04	Reads Multiple Input Registers
0x05	Writes a Single Coil
0x06	Writes a Single Register
0x0F	Writes Multiple Coils
0x10	Writes Multiple Registers
0x46	Reads/writes the Module Settings

#### Error Response

If the function specified in the message is not supported, then the module responds as below. Note that the address mapping for the Modbus protocol is Base 0.

Byte	Description	Length (in Bytes)	Value
00	Address	1	1 to 247
01	Function Code	1	Function Code + 0x80
02	Exception Code	1	01

Note: If a CRC mismatch occurs, the module will not respond.

### 3.1 Modbus Address Mapping(Base 1)

Address	Description	Attribute
30001 ~ 30008 40001 ~ 40008	Analog input value of channel 0 to 7. channel 0: CO in 1ppm, channel 1: CO2 in 1ppm, channel 2: PM2.5 in 1ug/m3, channel 3: relative humidity in 0.01%, channel 4: temperature in 0.01°C, channel 5:temperature in 0.01°F, channel 6: dew point temperature in 0.01°C, channel 7: dew point temperature in 0.01°F	R
40225 ~ 40232	High alarm limit of channel 0 to 7, channel 0: CO in 1ppm, channel 1: CO2 in 1ppm, channel 2: PM2.5 in 1 ug/m3, channel 3: relative humidity in 0.01%, channel 4: temperature in 0.01 ° C, channel 5:temperature in 0.01°F, channel 6: dew point temperature in 0.01°C, channel 7: dew point temperature in 0.01°F	R/W
40236 ~ 40240	Low alarm limit of channel 3 to 7, channel 3: relative humidity in 0.01%, channel 4: temperature in 0.01°C, channel 5:temperature in 0.01°F, channel 6: dew point temperature in 0.01°C, channel 7: dew point temperature in 0.01°F	R/W
40449	CO offset in 1ppm	R/W
40450	CO2 Offset in 1 ppm	R/W
40451	PM2.5 offset in 1 ug/m <sup>3</sup>	R/W
40452	Relative humidity offset in 0.01%	R/W
40453	Temperature offset in 0.01°C	R/W
40481	Firmware version (low word)	R
40482	Firmware version (high word)	R
40483	Module name (low word), 0x0213	R
40484	Module name (high word), 0x434C	R
40485	RS-485 module address, 1 to 247	R/W

Address	Description	Attribute
40486	RS-485 baud rate and parity settings Bits 5:0 Baud rate, valid range: 3 ~ 10 Bits 7:6 00: no parity, 1 stop bit 01: no parity, 2 stop bit 10: even parity, 1 stop bit 11: odd parity, 1 stop bit	R/W
40488	RS-485 response delay time in ms, valid range, 0 ~ 30	R/W
40489	RS-485 host watchdog timeout value, 0 ~ 255, in 0.1s	R/W
40492	RS-485 host watchdog timeout count, write 0 to clear	R/W
40496	Automatic baseline correction for CO2 measurement, 0: disable, 1:enable	R/W
40497	Beep on alarm, 0: disable, 1 to 250: beep on alarm time in seconds, 251: beep on alarm continuously	R/W
30513 ~ 30520 40513 ~ 40520	High latched analog input value of channel 0 to 7	R
30545 ~ 30552 40545 ~ 40552	Low latched analog input value of channel 0 to 7	R
40865	RTC year, 2000 to 2159	R/W
40866	RTC month, 1 to 12	R/W
40867	RTC date, 1 to 31	R/W
40868	RTC hour, 0 to 23	R/W
40869	RTC minute, 0 to 59	R/W
40870	RTC second, 0 to 59	R/W
40871	Total number of log records, low word	R
40872	Total number of log records, high word	R
40873	The starting record to read log data, low word	R/W

Address	Description	Attribute
40874	The starting record to read log data, high word	R/W
40875	The status of the data logging, 0: stopped, 1: running	R
40876	The data logger command, 0: stop, 1: run, 2: run in period mode	R/W
40877	Continue writing when data logger is full, 0: no, 1: yes	R/W
40878	Hour of the data logger sampling period, 0 ~ 24	R/W
40879	Minute of the data logger sampling period, 0 ~ 59	R/W
40880	Second of the data logger sampling period, 0 ~ 59	R/W
40881	Starting year when logging in period mode, 2000 ~ 2159	R/W
40882	Starting month when logging in period mode, 1 ~ 12	R/W
40883	Starting date when logging in period mode, 1 ~ 31	R/W
40884	Starting hour when logging in period mode, 0 ~ 23	R/W
40885	Starting minute when logging in period mode, 0 ~ 59	R/W
40886	Starting second when logging in period mode, 0 ~ 59	R/W
40887	Ending year when logging in period mode, 2000 ~ 2159	R/W
40888	Ending month when logging in period mode, 1 ~ 12	R/W
40889	Ending date when logging in period mode, 1 ~ 31	R/W
40890	Ending hour when logging in period mode, 0 ~ 23	R/W
40891	Ending minute when logging in period mode, 0 ~ 59	R/W
40892	Ending second when logging in period mode, 0 ~ 59	R/W
40929	The first fan off period in a day, beginning hour, 0 ~ 23	R/W
40930	The first fan off period in a day, beginning minute, 0 ~ 59	R/W
40931	The first fan off period in a day, ending hour, 0 ~ 23	R/W

Address	Description	Attribute
40932	The first fan off period in a day, ending minute, 0 ~ 59	R/W
40933 ~ 40936	The second fan off period in a day	R/W
40937 ~ 40940	The third fan off period in a day	R/W
40941 ~ 40944	The fourth fan off period in a day	R/W
40945 ~ 40948	The fifth fan off period in a day	R/W
40949 ~ 40952	The sixth fan off period in a day	R/W
00001	Digital output value of channel 0	R/W
00129	Safe value of digital output channel 0	R/W
00161	Power on value of digital output channel 0	R/W
00257	RS-485 Protocol, 0: DCON, 1: Modbus RTU	R/W
00260	Modbus RTU host watchdog mode 0: same as I-7000 1: can use AO and DO command to clear host watchdog timeout status	R/W
00261	RS-485 host watchdog mode, 1: enable, 0: disable.	R/W
00270	Host watch dog timeout status, write 1 to clear host watch dog timeout status Only for Modbus RTU protocol	R/W
00273	Reset status, 1: first read after powered on, 0: not the first read after powered on	R
00279	Fan control, 0: off, 1: on	R/W
00280	Write 1 to clear all high latched analog input values	W
00281	Write 1 to clear all low latched analog input values	W
00292 ~ 00296	Low alarm status of channel 3 to 7. Write 1 to clear low latched alarm.	R/W
00305 ~ 00312	High alarm status of channel 0 to 7. Write 1 to clear high latched alarm.	R/W



Address	Description	Attribute
00321 ~ 00328	Enable/disable alarm of channel 0 to 7	R/W
00337 ~ 00344	Alarm type, momentary or latched, of channel 0 to 7	R/W
00385 ~ 00392	Write 1 to clear high latched analog input value of channel 0 to 7	W
00417 ~ 00424	Write 1 to clear low latched analog input value of channel 0 to 7	W
00449 ~ 00456	Enable/disable beep on alarm for channel 0 to 7	R/W
00321 ~ 00328	Enable/disable alarm of channel 0 to 7	R/W