

Quick Start for ECAT-2515

English / Nov.2020/ Ver 1.0

1 Shipping Package

This shipping package contains the following items

1 x ECAT-2515 module

1 x Quick Start Guide (This Document)

Screw Driver x 1



2 Appearance

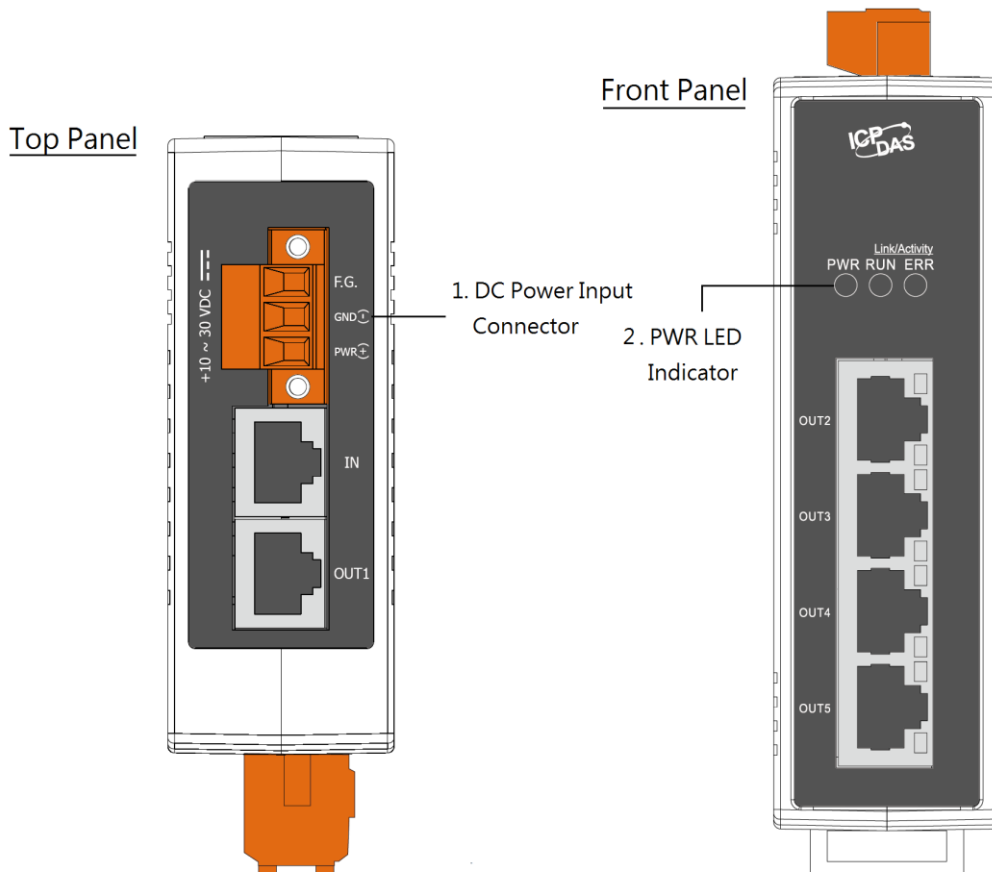

3 Connecting the Power and Host device

Switch on module and connect it to an EtherCAT network

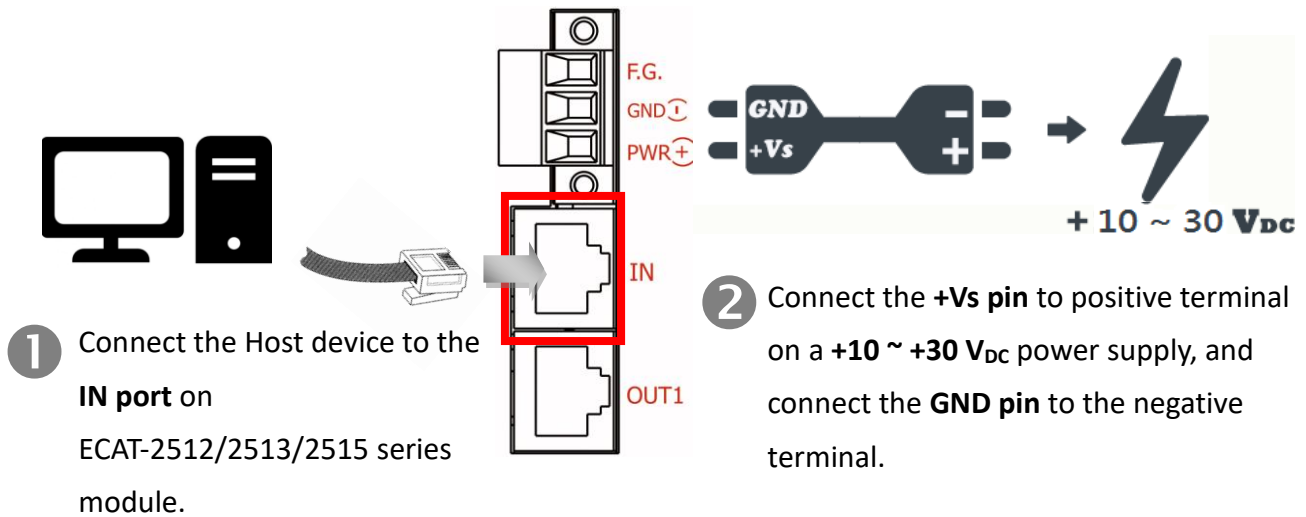

Verify the “PWR” LED indicator on the ECAT-2515 module is Red, “RUN” LED indicator is Green, “ERR” LED indicator is Yellow.

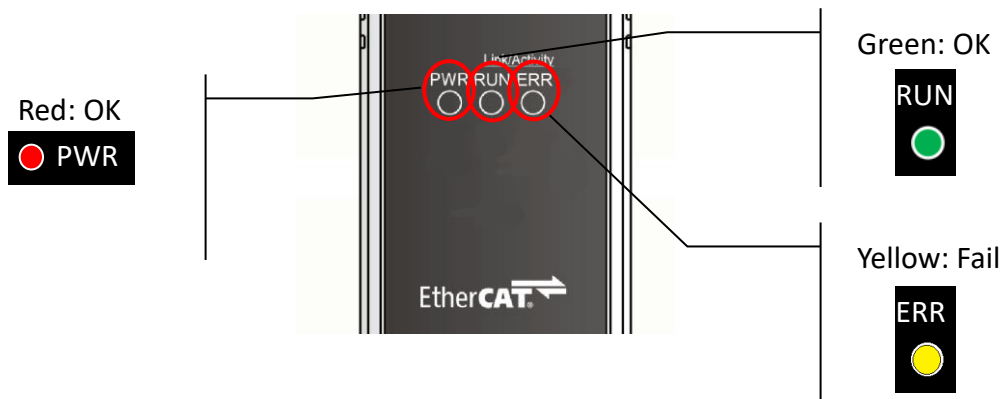

4 Connecting the Slave I/O Module

Connect the EtherCAT slave I/O module (e.g., the ECAT-2055) to **OUT port** on the ECAT-2515.

Refer to Figure 4-1 for illustrations of how to do this. Note that the ECAT-2055 module is used as an example. For other ECAT-2000 series module, refer to the specific Quick Start Guide or user manual for that ECAT-2000 series module.

- 1 Connect the IN port on the ECAT-2055 to OUT1 port on the ECAT-2515 module

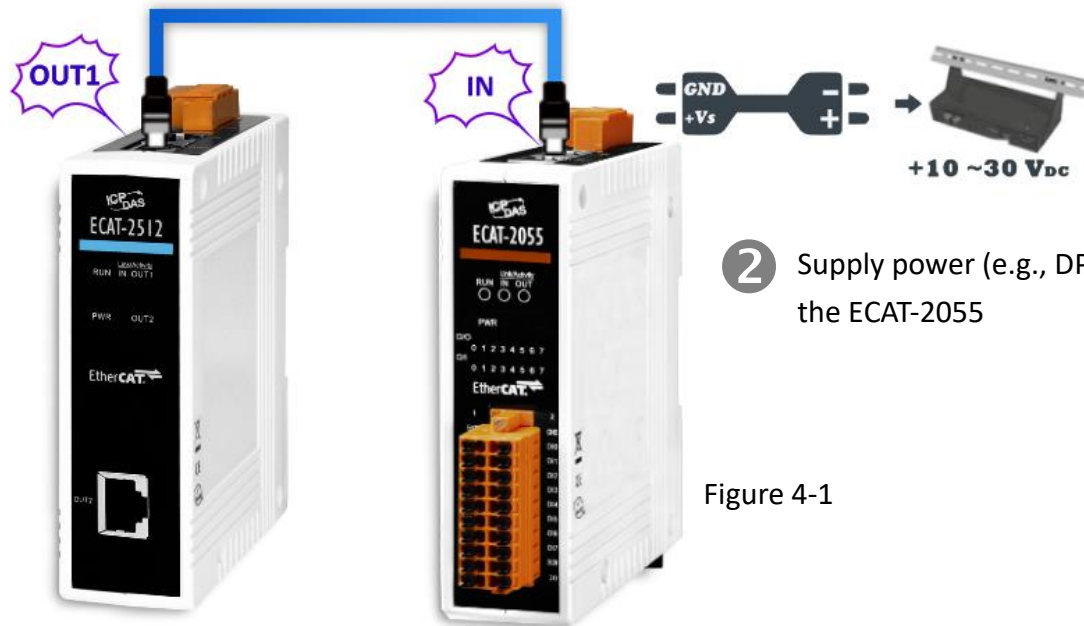

- 2 Supply power (e.g., DP-665) to the ECAT-2055

Figure 4-1

5 Search Modules

ESI file

The latest ESI file (ICPDAS ECAT-2515.xml) can be downloaded from ICP DAS website at

 http://ftp.icpdas.com/pub/cd/fieldbus_cd/ethercat/slave/ecat-2000/software/



Install the ESI file

Copy the "ICPDAS ECAT-2515.xml" file to the Master Tools installation folder, as indicated in the table below.

Software	Default Path
Beckhoff EtherCAT Configuration	C:\EtherCAT Configurator\EtherCAT
Beckhoff TwinCAT 3.X	C:\TwinCAT\3.x\Config\Io\EtherCAT
Beckhoff TwinCAT 2.X	C:\TwinCAT\Io\EtherCAT

Run the EtherCAT Master software (Beckhoff TwinCAT 2.X)

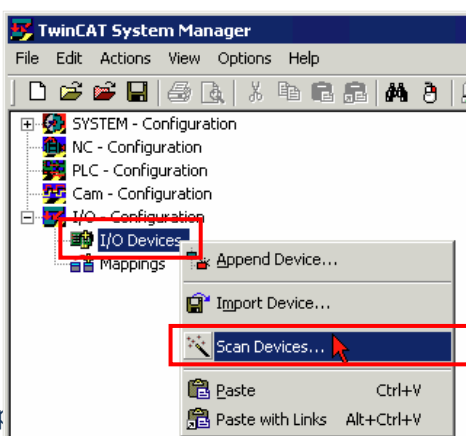

Switch on power
Execute the TwinCAT System Manager(Config mode)
I/O Devices-> Right click-> Scan Devices...

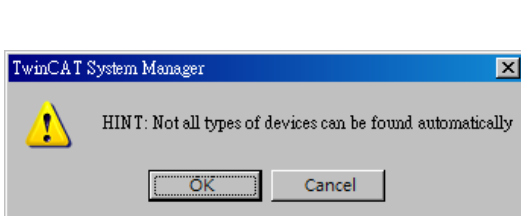

Click OK

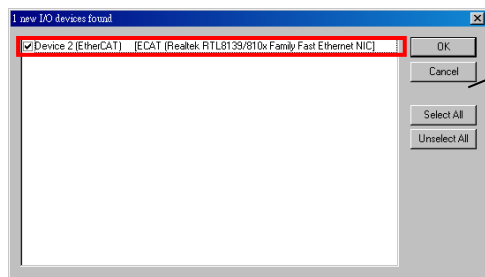

Choose the correct network device which is connected to ECAT-2515

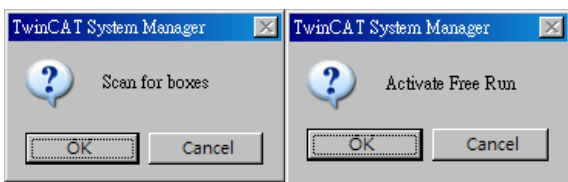

Click Yes to start scanning and click Yes to activate the free run mode for TwinCAT system manager

In the TwinCAT System Manager, the EtherCAT slave I/O module (e.g., ECAT-2055) will be listed under the ECAT-2512/2513/2515.

Number	Box Name	Address	Type	In Size	Out Size
1	Box 1 (ECAT-2512 3-Port)	1001	ECAT-2512 3-Port		
2	Box 2 (ECAT-2055 8DI/8DO)	1002	ECAT-2055 8DI/8DO	1.0	1.0
3	Box 3 (ECAT-2511-A Fiber)	1003	ECAT-2511-A Fiber		
4	Box 4 (ECAT-2511-B Fiber)	1004	ECAT-2511-B Fiber		
5	Box 5 (ECAT-2055 8DI/8DO)	1005	ECAT-2055 8DI/8DO	1.0	1.0

Related Information

Product Page:

http://www.icpdas.com/root/product/solutions/industrial_communication/fieldbus/ethercat/ethercat_selection_guide.html

ESI file:

http://ftp.icpdas.com/pub/cd/fieldbus_cd/ethercat/slave/ecat-2000/software/

DP-665 (Optional) Product Page:

http://www.icpdas.com/products/Accessories/power_supply/dp-665.htm