

CAN-2057D Release Note

1. The user manual of CAN-2000D series IO modules is located in
CD:\fieldbus_cd\DeviceNet\Slave\CAN-2000D
2. The user manual of CAN-2057D is located in
CD:\fieldbus_cd\DeviceNet\Slave\CAN-2000D\CAN-2057D\
3. For more information about CAN-2057D, please visit the following website:
http://www.icpdas.com/products/Remote_IO/can_bus/can-2057d.htm

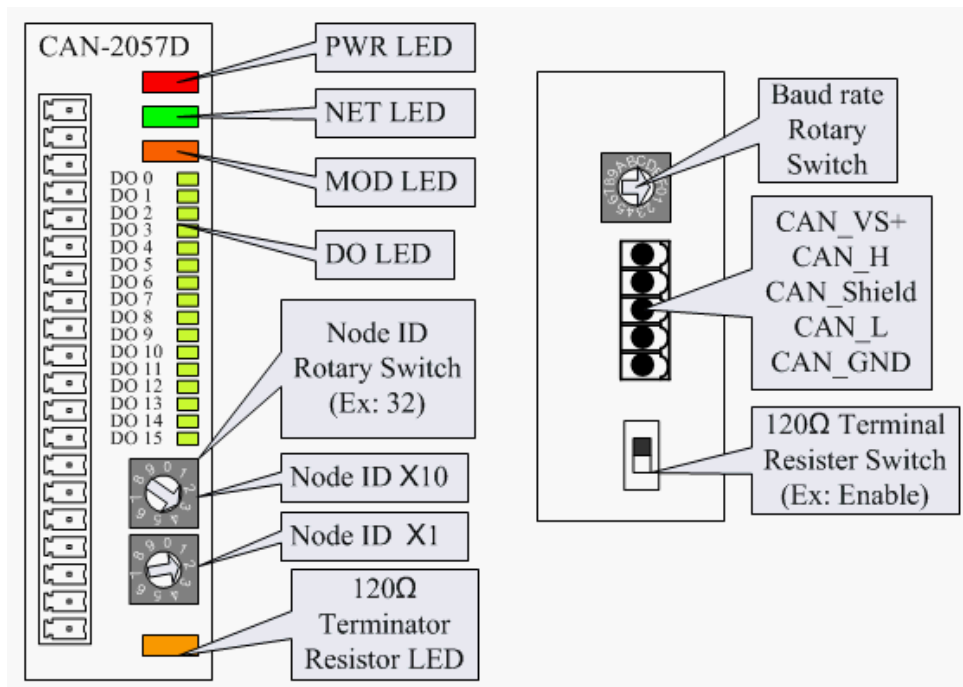

Technical Service :

- Email problem-report to **Service@icpdas.com** if you have any question.