

1. Connect the INIT\* pin with the GND Pin and the reboot the I-7241D module. After rebooting, the value on the 7segment led display will increase per second.

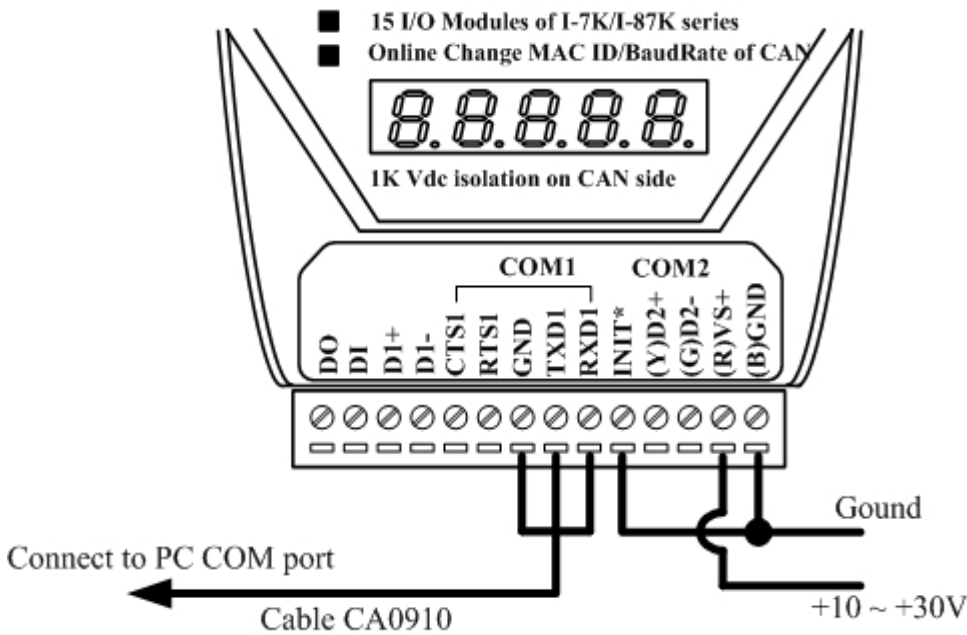

2. Open the 7188xw.ini file to setting the COM parameters of the 7188xw.exe file.

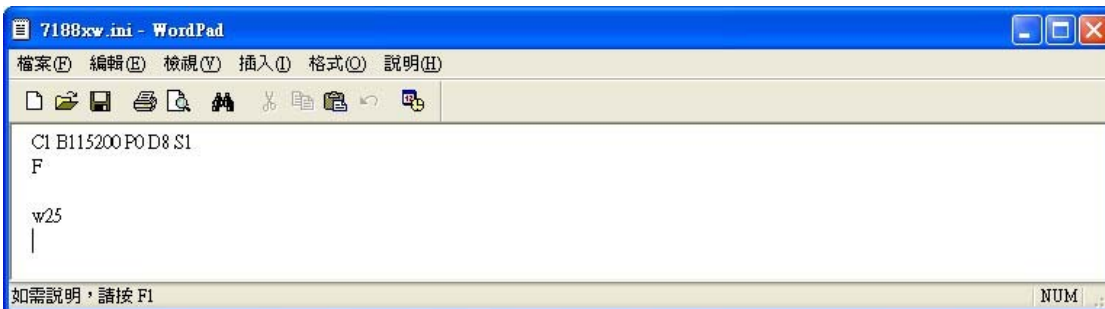

Modify the command "C1" on the 7188xw.ini to the COM port that you used

"C1" => COM 1

"C2" => COM 2

...

The other parameters do not need to be modified.

### 3. Execute the 7188xw.exe file

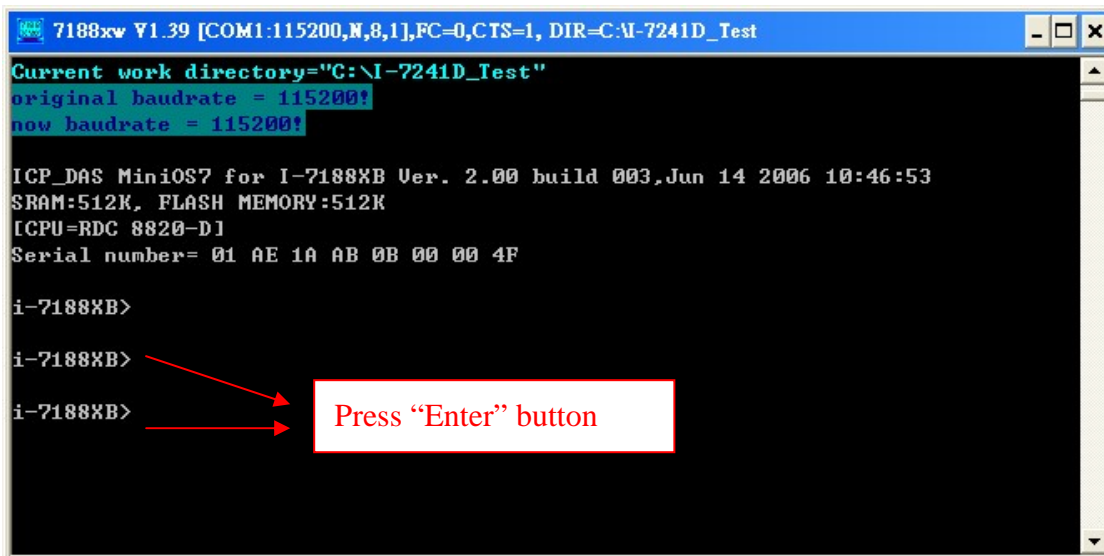

```
7188xw V1.39 [COM1:115200,N,8,1],FC=0,CTS=1, DIR=C:\I-7241D_Test
Current work directory="C:\I-7241D_Test"
original baudrate = 115200!
now baudrate = 115200!

ICP_DAS MiniOS7 for I-7188XB Ver. 2.00 build 003,Jun 14 2006 10:46:53
SRAM:512K, FLASH MEMORY:512K
[CPU=RDC 8820-D]
Serial number= 01 AE 1A AB 0B 00 00 4F

i-7188XB>
i-7188XB>
i-7188XB>
```

When I-7241D booting up on init mode, there will display following information on the 7188xw.exe.

ICP\_DAS MiniOS7 for I-7188XB Ver. 2.00 build 003,Jun 14 2006 10:46:53  
SRAM:512K, FLASH MEMORY:512K  
[CPU=RDC 8820-D]

Press "Enter" button on the keyboard, and make sure there is "i-7188XB>" information displayed on the screen.

If there is no message displayed on the screen, please make sure the download cable is successful connect with the I-7241D.

4. Press “F4” button on the keyboard to start to download the firmware. Then the 7188xw.exe will start to download firmware into I-7241D. After successfully downloading firmware, there will display “i-7188XB>” on the screen

```
7188xw V1.39 [COM1:115200,N,8,1],FC=0,CTS=1, DIR=C:\I-7241D_Test
i-7188XB>
i-7188XB>del /y
Total File number is 2, do you really want to delete(y/n)?
i-7188XB>LOAD
File will save to 8000:0000
StartAddr-->7000:FFFF
Press ALT_E to download file!
Load file:autoexec.bat[crc=ED78,0000]
Send file info. total 1 blocks
Block 1
Transfer time is: 0.047000 seconds
i-7188XB>LOAD
File will save to 8002:0006
StartAddr-->8000:0025
Press ALT_E to download file!
Load file:DN_DC.EXE[crc=DA7C,0000]
Send file info. total 436 blocks
Block 436
Transfer time is: 20.719000 seconds
i-7188XB>
```

5. After successfully downloading the firmware, please remove the shorted line between the INIT\* pin and GND pin. And then re-boot the I-7241D module.