

CAN-8123/ CAN-8223/CAN-8423 CANopen Slave Device

Quick Start User Guide

Introduction

This user guide introduces the user how to implement the CAN-8123/CAN-8223/CAN-8423 into their applications in a quick and easy way. Therefore, it only provides the basic instructions. For more detail information about the CAN-8123/CAN-8223/CAN-8423, please refer to the CAN-8123/CAN-8223/CAN-8423 user manual in the product CD or download it from following web site:

http://www.icpdas.com/products/Remote_IO/can_bus/can-8123.htm

or

http://www.icpdas.com/products/Remote_IO/can_bus/can-8423.htm



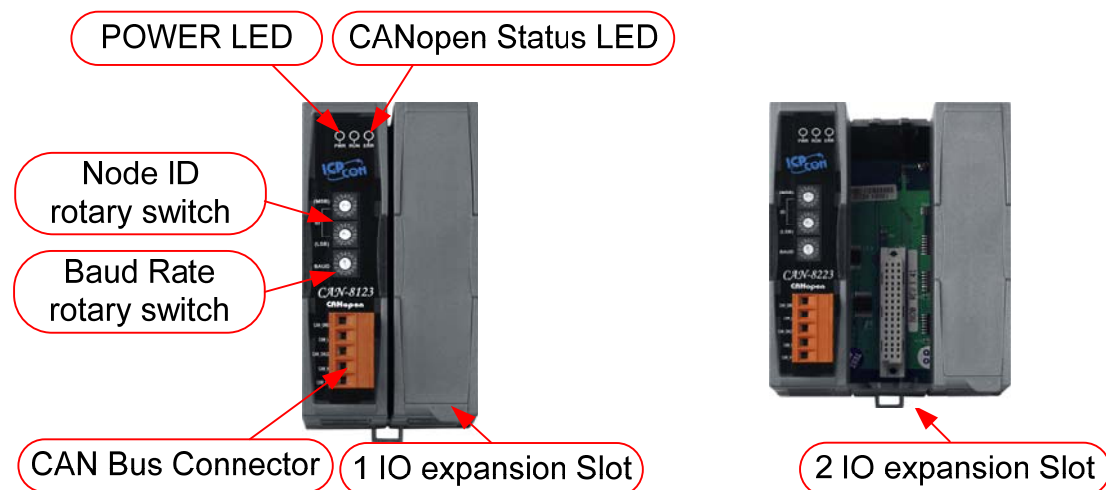

CAN-8123/CAN-8223 Hardware Structure

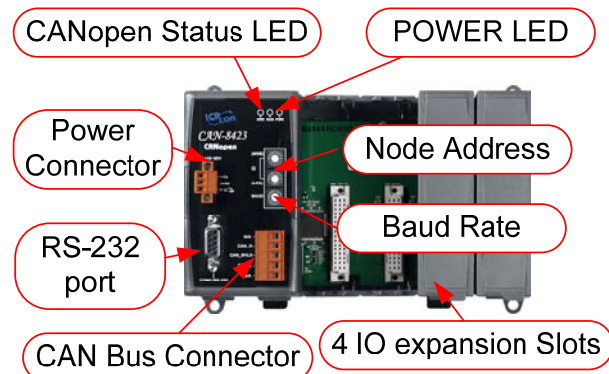





CAN-8423 Hardware Structure



CAN-8123/ CAN-8223 CAN bus connectors pin assignment

CAN_GND		Pin 1	Pin	Signal	Description
CAN_L		Pin 2	1	CAN_GND	Ground (0V)
CAN_Shield		Pin 3	2	CAN_L	CAN_L bus line (dominant low)
CAN_H		Pin 4	3	CAN_SHLD	Optional CAN Shield
CAN_V+		Pin 5	4	CAN_H	CAN_H bus line (dominant high)
			5	CAN_V+	CAN external positive supply

CAN-8423 CAN bus connectors pin assignment

N/A		Pin 1	Pin	Signal	Description
CAN_H		Pin 2	2	CAN_H	CAN_H bus line (dominant high)
CAN_Shield		Pin 3	3	CAN_SHLD	Optional CAN Shield
CAN_L		Pin 4	4	CAN_L	CAN_L bus line (dominant low)
N/A		Pin 5			

Power and CAN Connection

The CAN-8123/CAN-8223/CAN-8423 CAN connector is standard 5-pin screw terminal connector. Users can connect it directly with any other standard male 5-pin screw terminal. Take a note that the CAN-8423 power pin of CAN connector is useless. Therefore, users need to give CAN-8423 power by using power connector. Please refer to the CAN-8423 Hardware Structure described before.

Terminal Resistance

In order to minimize the reflection effects on the CAN bus line, the CAN bus line has to be terminated at both ends by two terminal resistances. The CAN-8123/CAN-8223/CAN-8423 has the 120Ω terminal resistance inside. The JP2 of the CAN-8123/CAN-8223 and the JP1 of the CAN-8423 is for terminal resistance. Their position and jumper status are shown in the following figure.

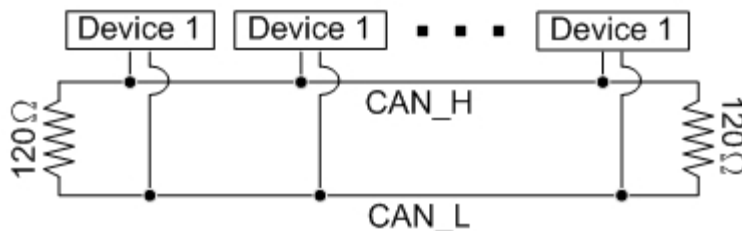

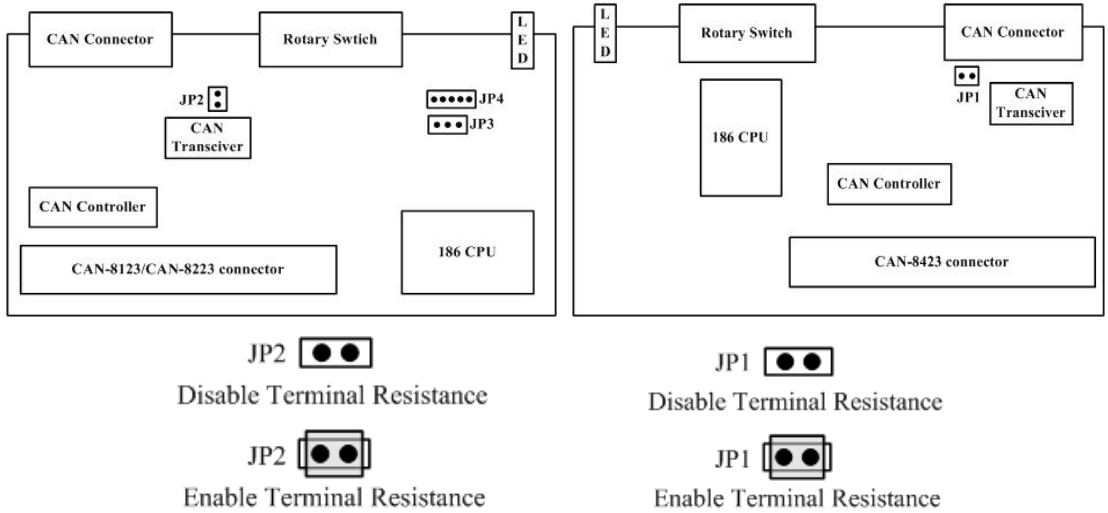

Install CANopen Slave Utility

Step1:Download the CANopen Slave Utility file from the web site

<http://www.icpdas.com/download/index.htm>

or CD-ROM disk following the path:

“/CANopen/Slave/CAN-8x23/Utility/CANopen_SL.exe”

Step 2: Execute the CANopen_SL.exe file to configure the CANopen Slave.

CAN-8123/ CAN-8223 Configuration (Off-line mode)

Step 1: Select the “Setting status” to offline. Here, assume that users’ CANopen slave device is CAN-8223 with node id 123 and baud rate 1000Kbps. Fill the correct value of users’ CAN-8223 node id and baud in the “NODE ID” and “CAN Baud rate” filed. Then, select the “Slot Number” to “2 Slot”.

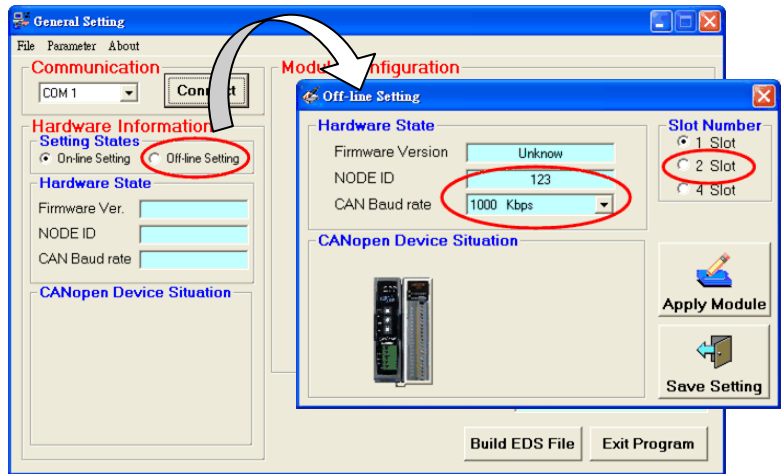

Step 2: Assume that users plug the I-8024 and I-8042 slot modules in the slot 0 and 1 respectively. Click the slot 0 icons shown in the “CANopen Slave Device Situation” frame.

Select 8024 in the list box, and click button “Apply Module” to save the configuration. After finish the configuration, users can slip the mouse point to the slot module in the “CANopen Slave Device Situation” frame. Afterwards, add another module I-8042 in the slot 1 by following the method described before. When all slot are configured, click “Save Setting” to go on the next.

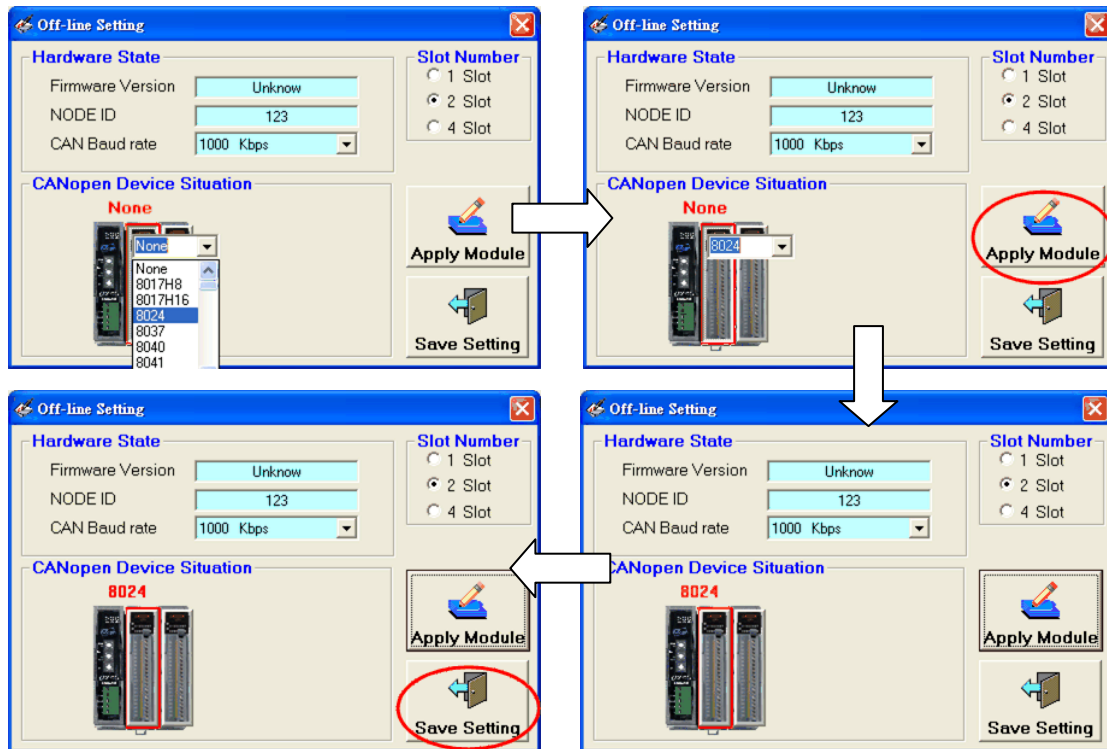

Step 3: Users can check the default settings for each slot module by clicking this module. Or move the mouse pointer on the slot module to see the module name and module information in the “Module Information” frame.

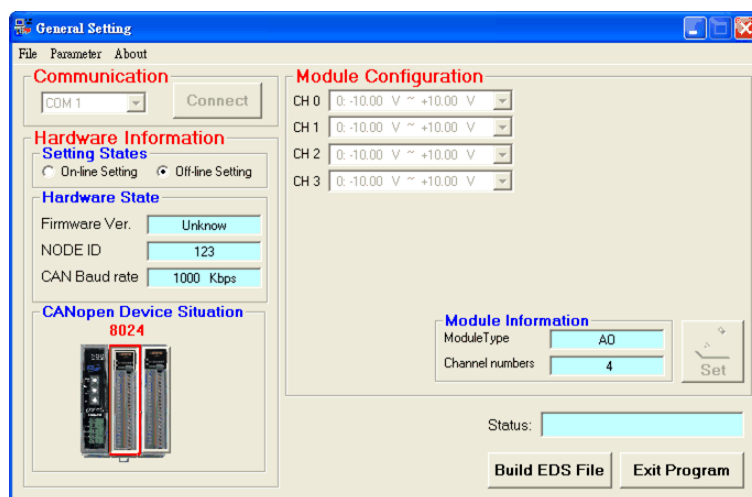

Step 4: The two fields, “description” and “create by”, can help users to do some notes in the EDS file. If they are empty, the “ICPDAS CANopen I/O Slave Device” and “ICPDAS” will be

used for the default value. Users can also click on the “PDO Information”, “Device Information “, and the “Slot Module Information” button to view the PDO objects, device profile and slot module information. If everything is ok, click the “Finish” button to create the EDS file.

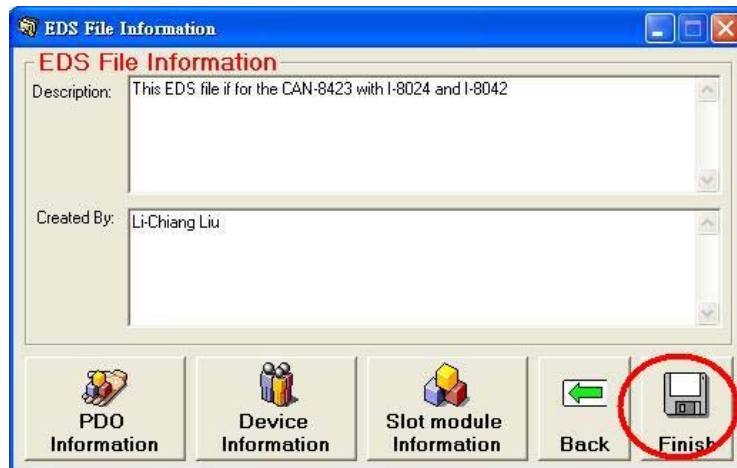

Note: If users use off-line method to get the EDS file, the objects which are used to record the input/output range of the analog modules will be described to default value in the EDS file. However, the I-87K slot modules hold the input/output range parameter settings in their own EEPROM. It may cause the mismatch between real input/output range setting and EDS file. By the way, II-8KCPSx needs to configure the input/output range settings by using CANopen SDO protocol. For more detail, please refer to the section 5.5 in CAN-8123/CAN-8223/ CAN-8423 user manual.

CAN-8423 Configuration (On-line mode)

Before using the CAN Slave utility, please make sure that you have connected COM1 of the CAN-8423 with the available COM port on your PC. The architecture is displayed in the following figure. In this example, the CAN-8423 will be used, and slot modules, I-87057, I-87057, I-87024 and I-87017H are plugged in the slot 0, 1, 2, 3 respectively (If users don't have any slot module, they can also follow this demo to configure their CAN-8423. But some situation or information relative with slot modules will be difference).

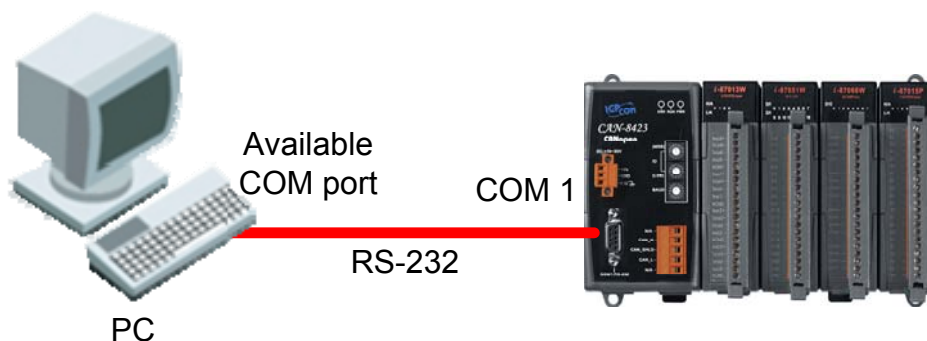

Step 1: Turn off the CAN-8423. Set the “Baud” rotary switch of CAN-8423 to 9 for configuration mode. Then Turn on the CAN-8423.



Step 2: Use the “ID” rotary switch and “Baud” rotary switch to set the baud rate of CAN-8423. The node ID is useless when the value exceeds the 7F (127 for decimal format) because of the CANopen spec definition. The relationship between the rotary switch value and practical baud rate is displayed in the following table. Here, use ID 123 and baud rate 1000Kbps for the demo. Therefore, set the “ID” rotary switch to “7B” ($7B=7*16+B=112+11=123$) and “Baud” rotary switch to 7.

	Rotary Switch Value	Baud rate (K BPS)
(MSB)	0	10
ID	1	20
	2	50
(LSB)	3	125
BAUD	4	250
	5	500
	6	800
	7	1000

Step 3: Execute the CANopen_SL.exe file, and the figure will be displayed. Select a PC COM port to connect the CAN-8423. Here, use PC COM1 for this demo. Therefore, users need to click the “PC COM Port” list box, set it to COM1, and click button “Connect” to connect the CAN-8423. Afterwards, the utility tool will get the information stored in the CAN-8423.

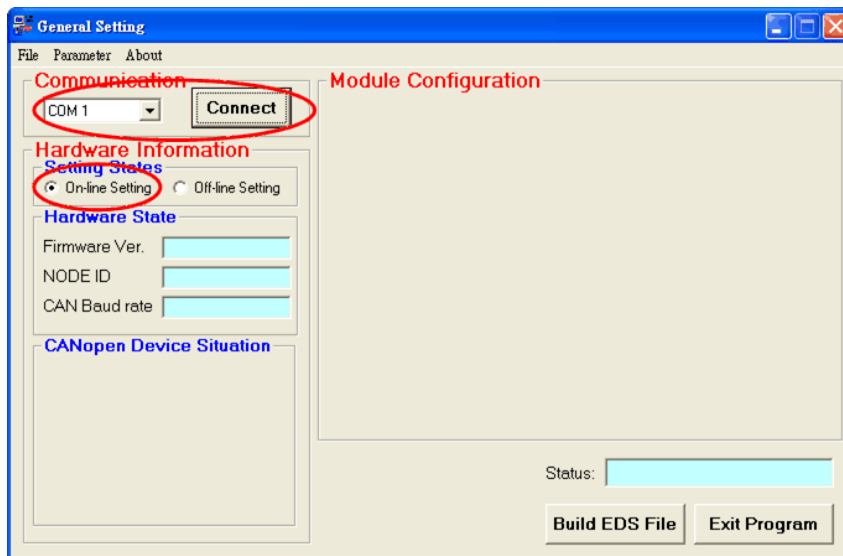

Step 4: Users can move the mouse pointer to the slot of CAN-8423 shown in the “CANopen Slave Device Situation” to get the module information of this slot module.

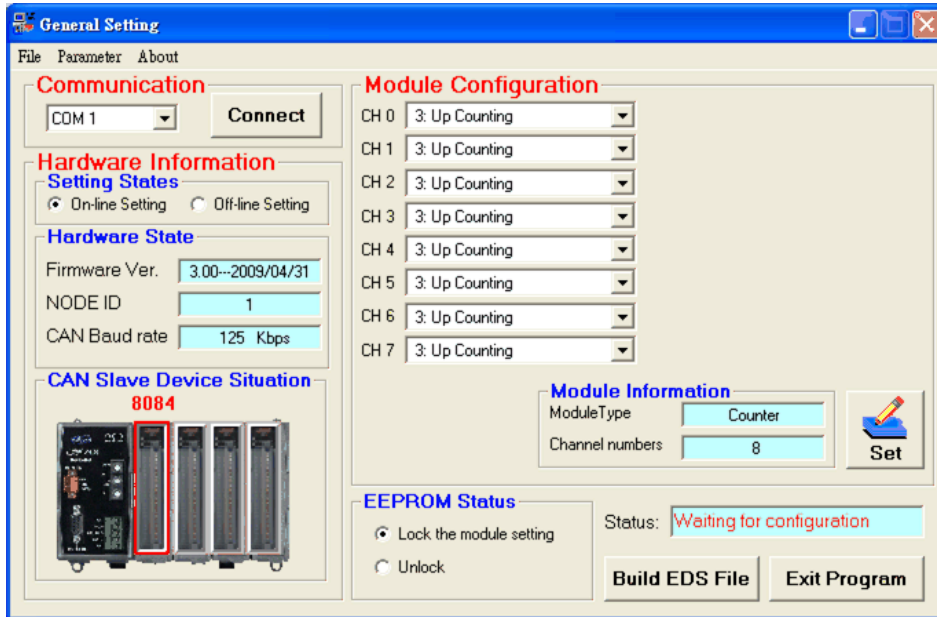

Step 5: Click the slot module 3. Here, select the output range to -10.00V~+10.00V in the list box of “Module Configuration” frame for example. Because the feature of I-8024 slot module, each channel output range will be changed together after users select the output range of one channel. Click “Set” button to store the parameter setting. If all of slot module configurations are finished, click “Build EDS File” button to go on the next step.

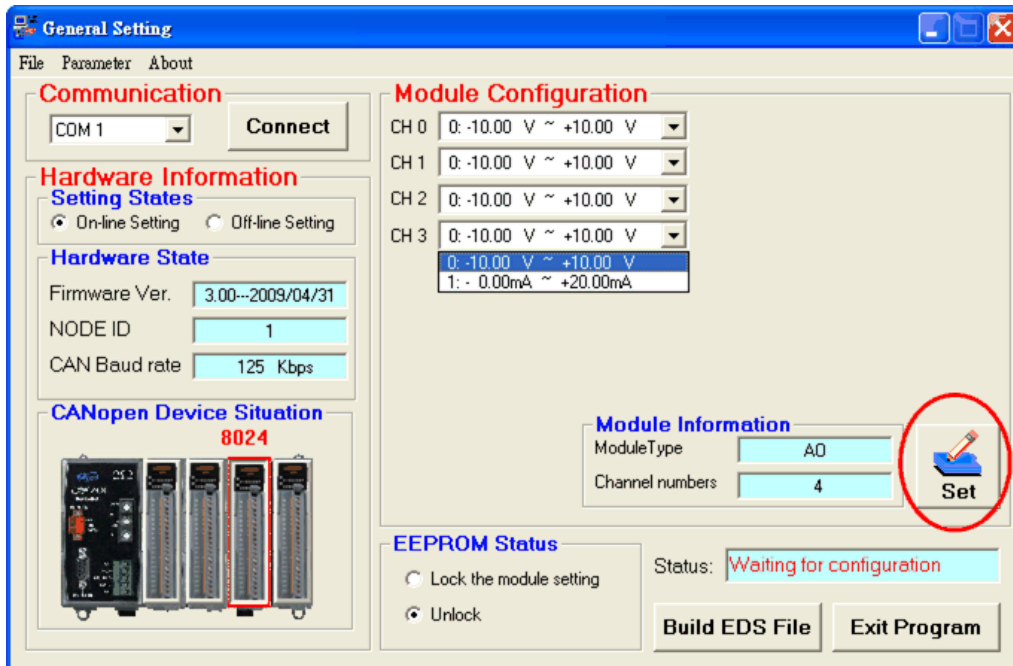

Step 6: Afterwards, users can see the “EDS File Information” window, and fill the “Description” and “Create by” filed for the EDS file. Also, users can see the CANopen objects information and modules information by click the buttons. Please refer to the step 6 in the off-line setting described before.

Note: The CAN-8423 can also create the EDS file by using off-line mode, and set the analog input range or analog output range by using the CANopen SDO protocol. For more detail, please refer to the section 5.5 in CAN-8123/CAN-8223/CAN-8423 user manual.

Application Procedure

