

# EIP-2055 Quick Start Guide



*For EIP-2000 Series*

English/ January 2013/ Version 1.0



## What's in the shipping package?

The package includes the following items:



**EIP-2055**



**CD**

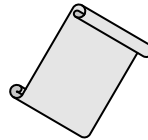

**Quick Start Guide**  
(This Document)



**Screw Driver**



## Installing software on your PC

### ■ Install EIP-2000 Utility:

The software is located at:

Fieldbus\_CD:\EtherNetIP\remote-io\EIP-2055\Utility

# 3 Connecting the Power and PC

1. Make sure your PC has workable network settings.
2. Disable or well configure your Windows firewall and anti-virus firewall first, else the “Network Scan” on step 4 may not work. (Please contact with your system Administrator)
3. Check FW/OP DIP switch if it is on **OP** position.

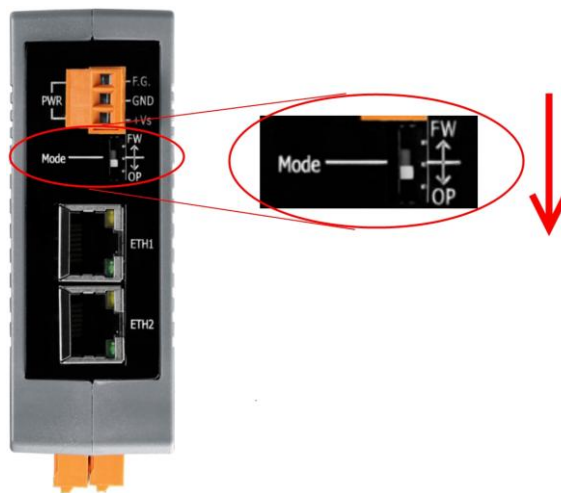

4. Connect both the EIP-2000 and your computer to the same sub network or the same Ethernet switch, and power the EIP-2000 on.

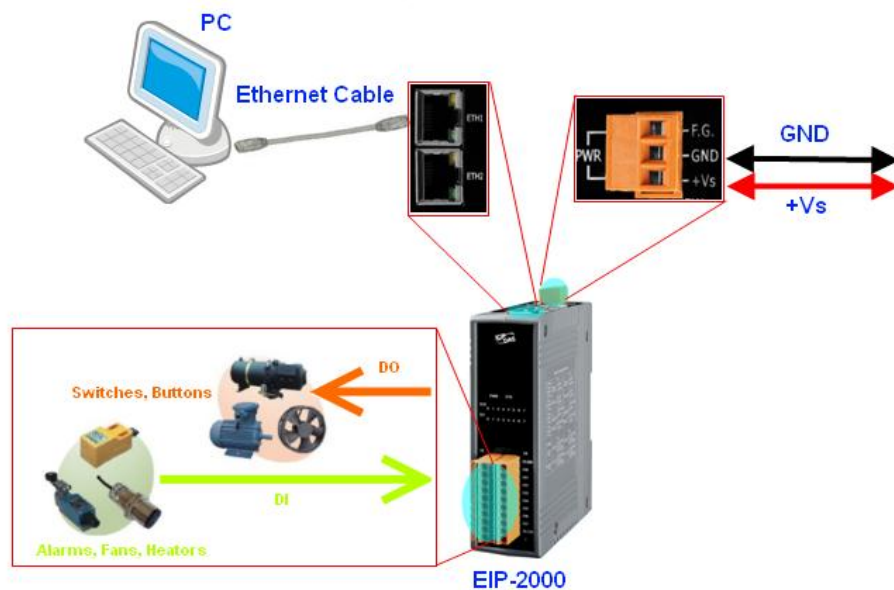

## 5. I/O connector – EIP-2055

20-pin Spring-type terminal connector			
Pin	Description	Pin	Description
1	DI.COM	2	EXT.PWR
3	DI7	4	DO7
5	DI6	6	DO6
7	DI5	8	DO5
9	DI4	10	DO4
11	DI3	12	DO3
13	DI2	14	DO2
15	DI1	16	DO1
17	DI0	18	DO0
19	DI.GND	20	EXT.GND

## 6. I/O Wire Connection

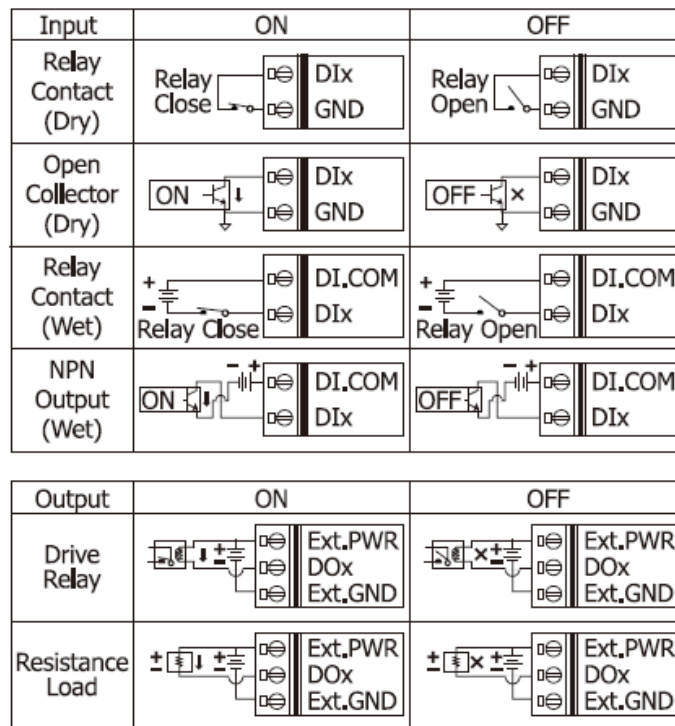

# 4 Using the EIP-2000 Utility

1. Double click the “EIP-2000 Utility” shortcut on the desktop.
2. Click the “Network Scan” button to search your EIP-2000 modules.

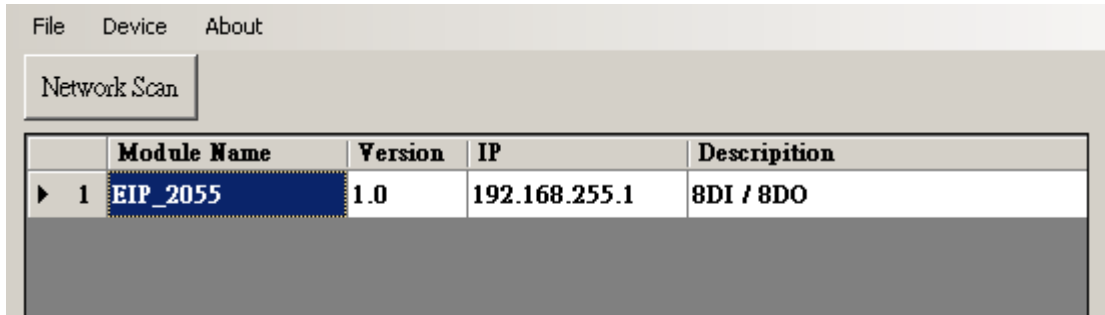

3. Click the **EIP-2055** or other **EIP-2000** modules on the device list below to open the configuration dialog of **EIP-2000**. Each EIP-2000 module has its own configuration interface.
4. Test the digital outputs by clicking on the red circles, and the green circles indicate the status of digital input status.

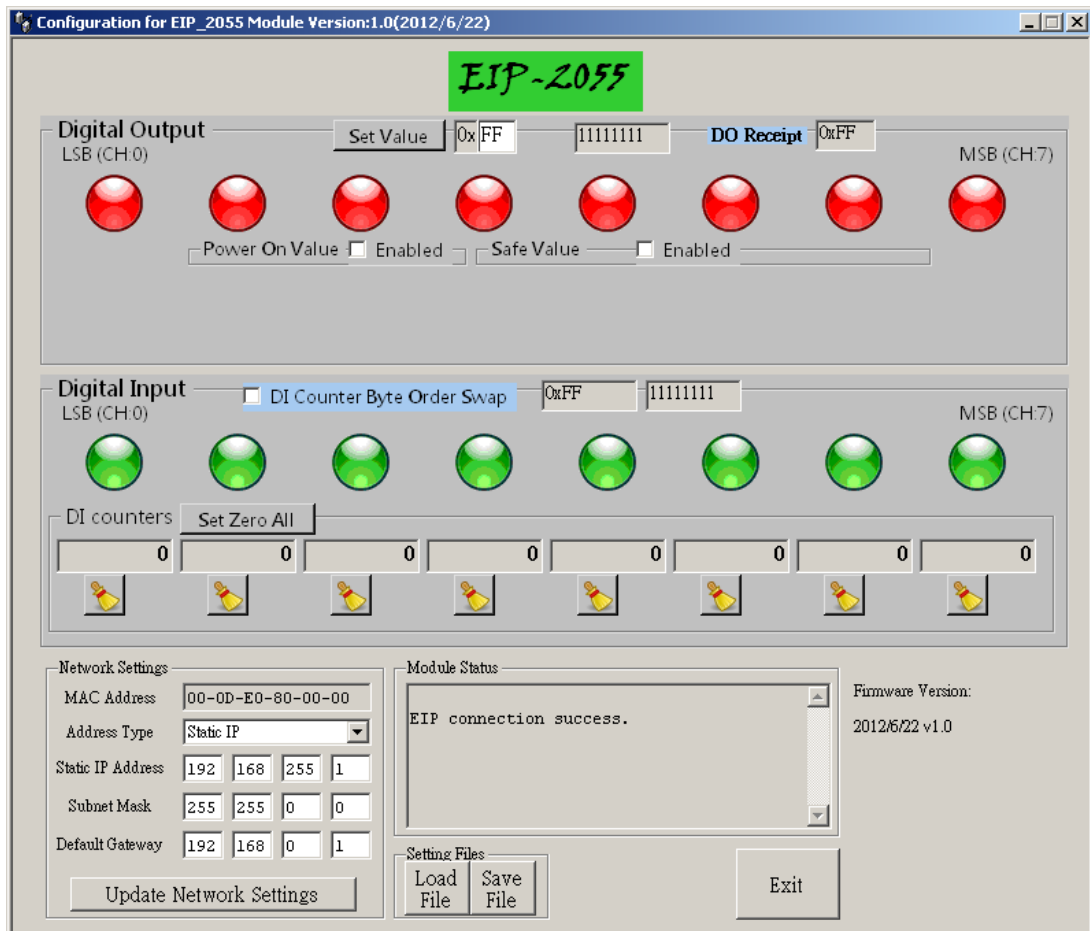

5. The “Power On Value”, “Safe Value” and “Safe Delay” for digital output can be set without rebooting the module.

6. If the network settings have been changed, please click the “Update Network Settings” button to update the configuration and reboot the module.

7. Configuration settings of EIP-2000

Network Settings	
Item	Settings (default)
IP	192.168.255.1
Gateway	192.168.0.1
Mask	255.255.0.0

For configuration of the Address Type, Static IP Address, Subnet Mask and Default Gateway of the EIP-2000. Please refer to section “4.2.1 Network Settings”

LED Indicator		
LED	LED Status	Description
Power LED	Always On	Module is in Run mode.
	Flashing	Module is in Init mode.
Status LED	Always On	EtherNet/IP connection is failed.
	Blink per second	EtherNet/IP connection is successful.
	Blink per 300 ms	EtherNet/IP disconnected during communication but still in Safe-Delay time.
	Blink per 100 ms	Module is about to reboot.
I/O status LED	On	The DI/DO is activated.
	Off	The DI/DO is inactivated.

For configuration of the Power On Value, Safe Value, Safe Delay for the EIP-2000. Please refer to section “4.2.2 Digital Settings”

# 5 How to connect with Allen-Bradley PLC ?

1. Open RSLogix 5000 and create a new project.



Figure5-1. Create a new project.

2. Select the PLC type and give the project a name.

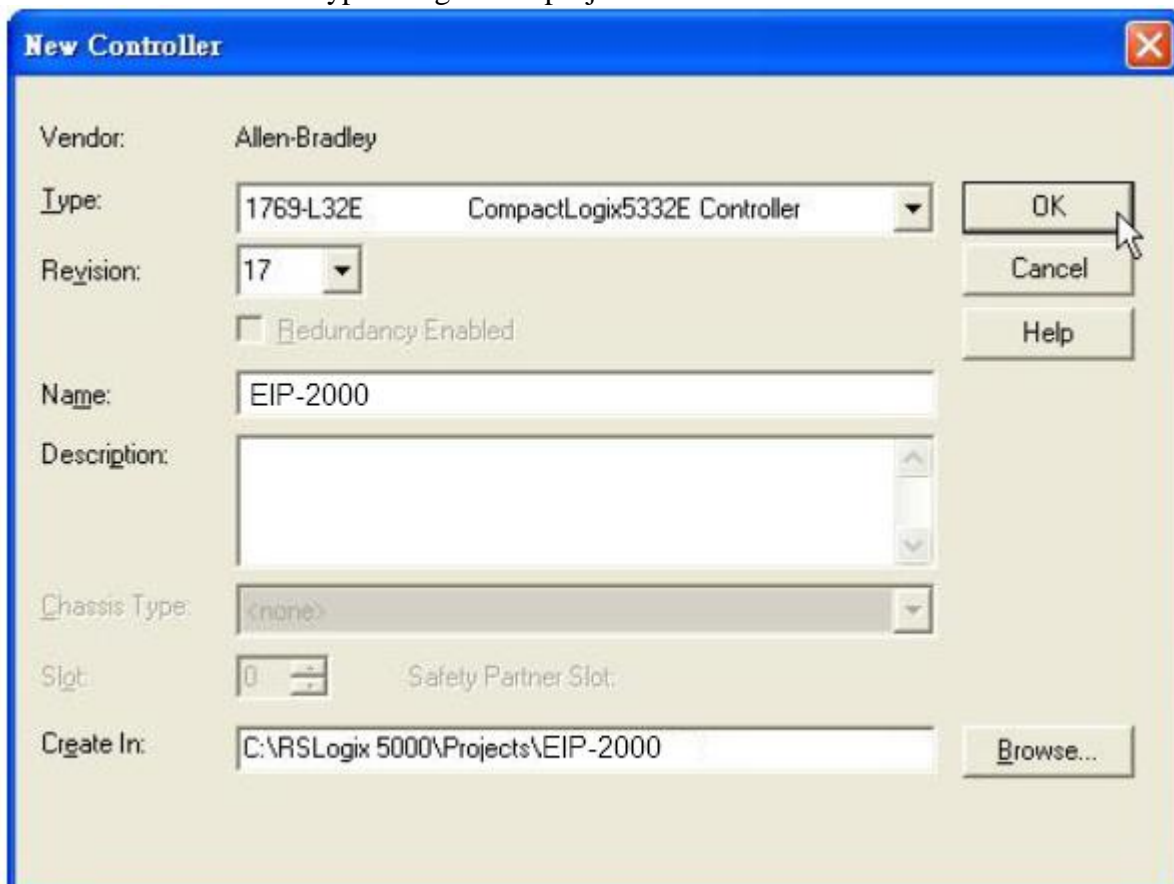

Figure5-2. Set the PLC type and project name.

3. Create a new module in the “Ethernet” item.

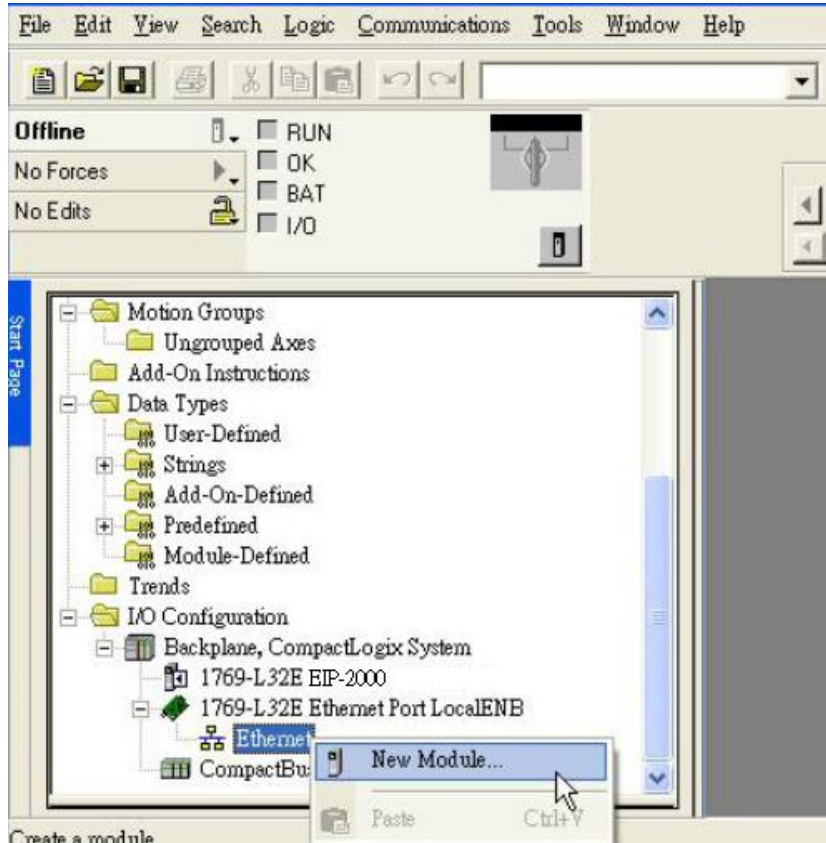

Figure 5-3. Create a new module.

4. Select the “ETHERNET-MODULE” below “Communications” in the Select Module window.

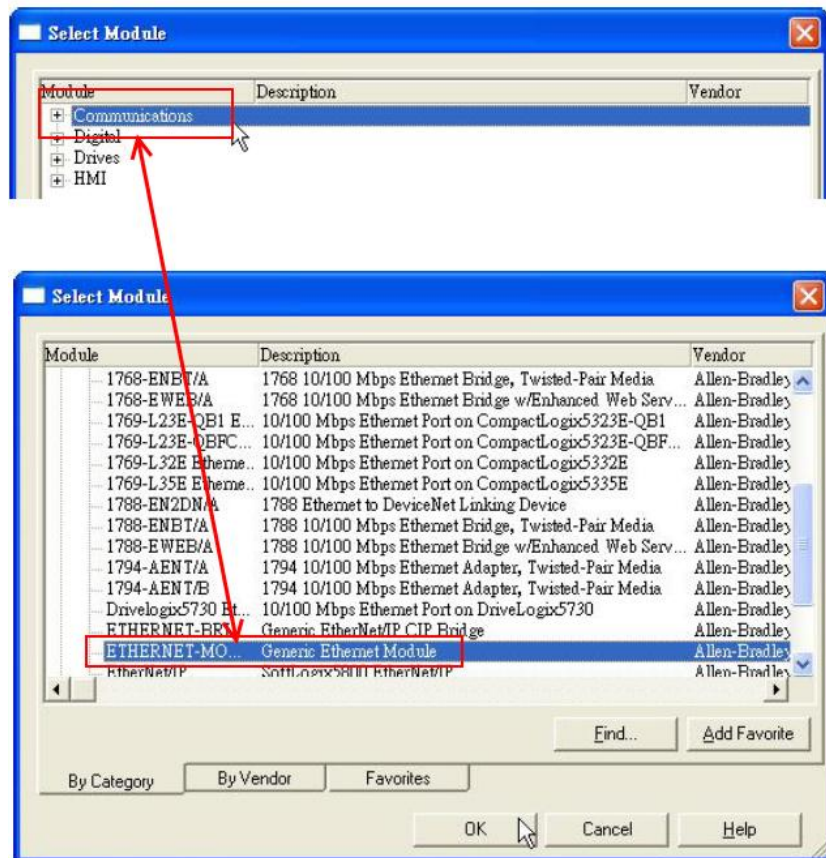
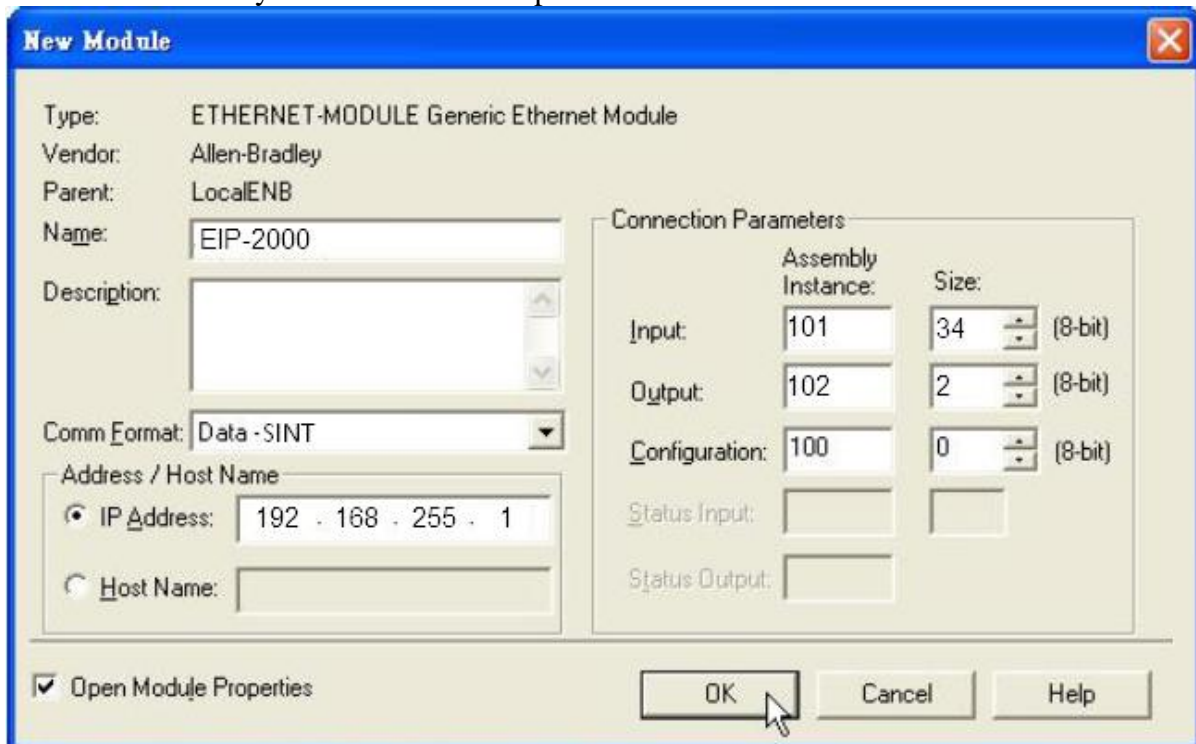

Figure 5-4. Select “ETHERNET-MODULE”.

- Configure the new module parameters. The I/O length of new module must be the same with the length of EIP-2055 I/O data(Table 5-1). The input data size is 34 bytes and output data size is 2 bytes. The instance ID please refer to Table 5-2.



**Figure5-5. The settings of EIP-2055 module**

**Table 5-1. Data Assembly of EIP-2055**

Data Assembly	Byte count	Description
<b>Input Assembly</b>	34	1 <sup>st</sup> Byte: DI status
		2 <sup>nd</sup> Byte: DO status read back
		3 <sup>rd</sup> ~34 <sup>th</sup> Byte: DI counters
<b>Output Assembly</b>	2	1 <sup>st</sup> Byte: DO status
		2 <sup>nd</sup> Byte: to set DI counters zero

**Table 5-2. Instance ID table of EIP-2000**

Implicit Message Information of EIP-2000		
Instance	Instance ID	Data length
<b>Input(T-&gt;O)</b>	65 <sub>hex</sub> (101)	Depends on modules. e.g.34
<b>Out(O-&gt;T)</b>	66 <sub>hex</sub> (102)	Depends on modules. e.g.2
<b>Configuration</b>	64 <sub>hex</sub> (100)	