

Packing List

In addition to this guide, the package includes the following items:



WP-5231PM-3GWA-CE7



**microSD card and
micro SD/SD adapter**

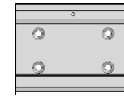

**M3x6L Screw * 4
44 mm DIN-Rail Clip**



**GSM/GPRS External Antenna
and GPS Active External Antenna**



Wire Terminal * 16



Screw Driver

Technical Support

service@icpdas.com

www.icpdas.com

Resources

How to search for drivers, manuals and spec information on ICP DAS website.

- For Mobile Web

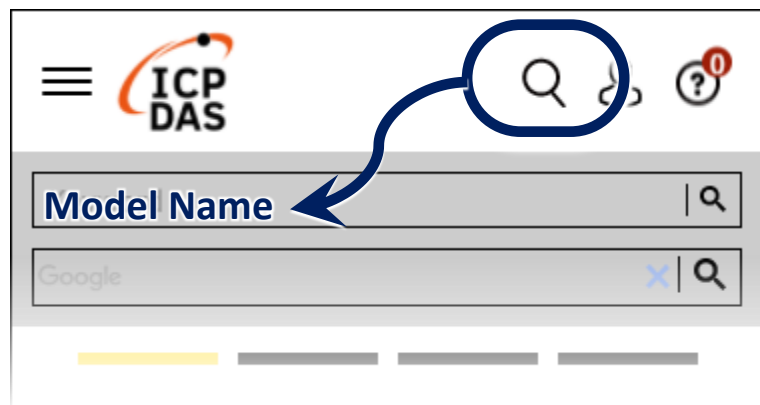

- For Desktop Web

1 Configuring the Boot Mode

Before starting any installation, be sure that the switch is placed in the '0' position.



2 Installing the SIM card and antenna

- 1) Push the ejection button to pull out the tray.
- 2) Put the SIM card in the tray, and then push the tray back into the socket
- 3) Screw the GSM/GPRS and GPS antenna tightly into the antenna connectors

Ejection button



3 Connecting to PC, Monitor and Power Supply

- 1) Connect the mouse or keyboard to the USB port.
- 2) Connect PC to the Ethernet port through an Ethernet switch.
- 3) Connect the power supply (+12 to +48 VDC) to PWR and P.GND terminals.
- 4) Connect the monitor to the VGA port.

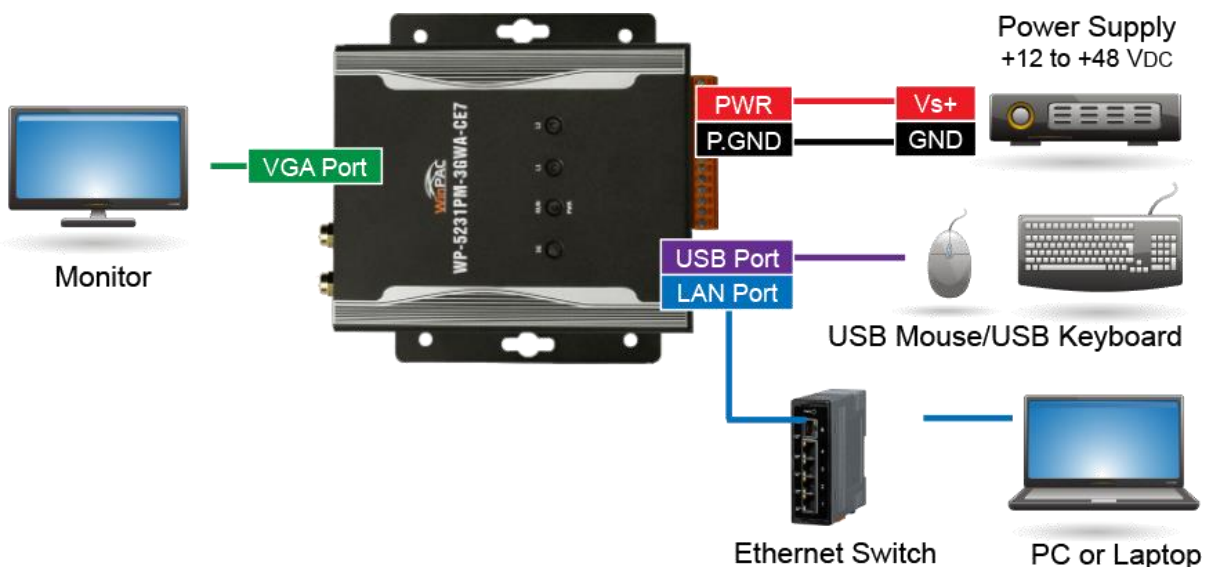

4 Mounting the WP-5231PM-3GWA-CE7

The WP-5231PM-3GWA-CE7 can be mounted either directly to a wall/panel.

- 1) Install the four mounting screws into the 4 keyhole mounting holes
- 2) Fasten the screws securely

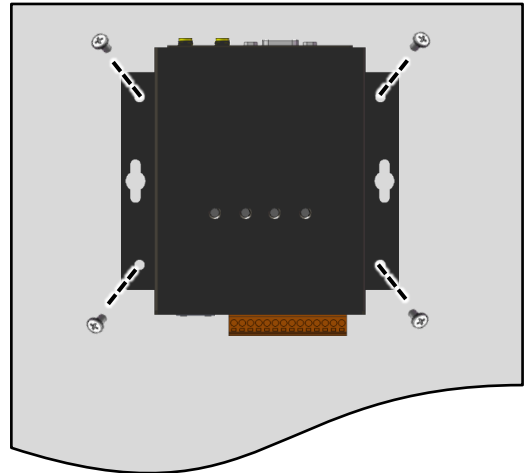

5 Changing the User Interface Language

- 1) Click Start menu, point to Settings, click Control Panel, and then click Regional Settings

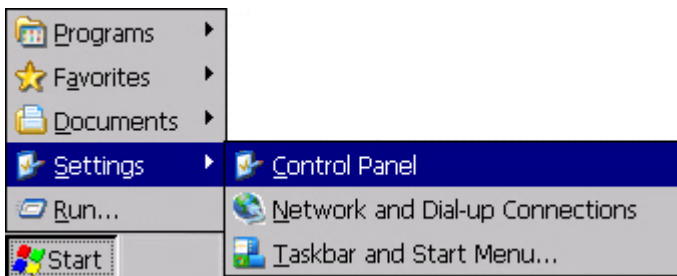

- 2) Click User Interface Language tab, choose to your local language, and then click OK button

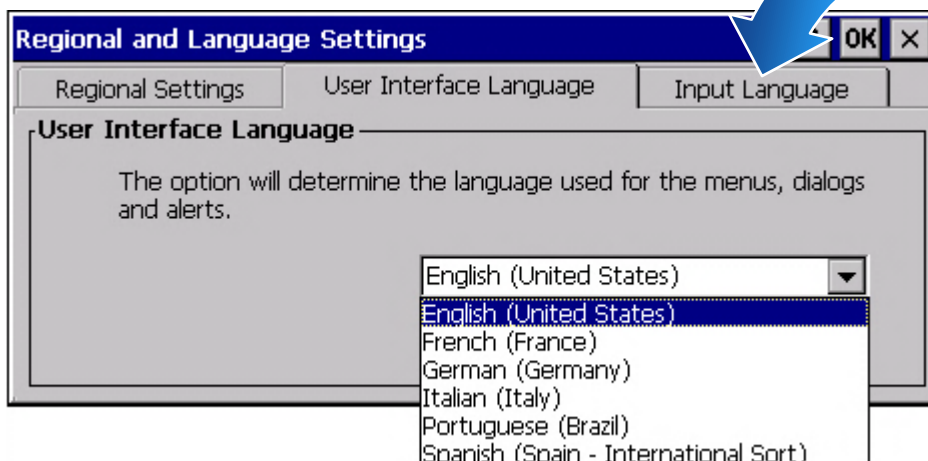

- 3) Double-click the PAC Utility on the desktop, and then reboot the WP-5231PM-3GWA-CE7 for changes to take effect

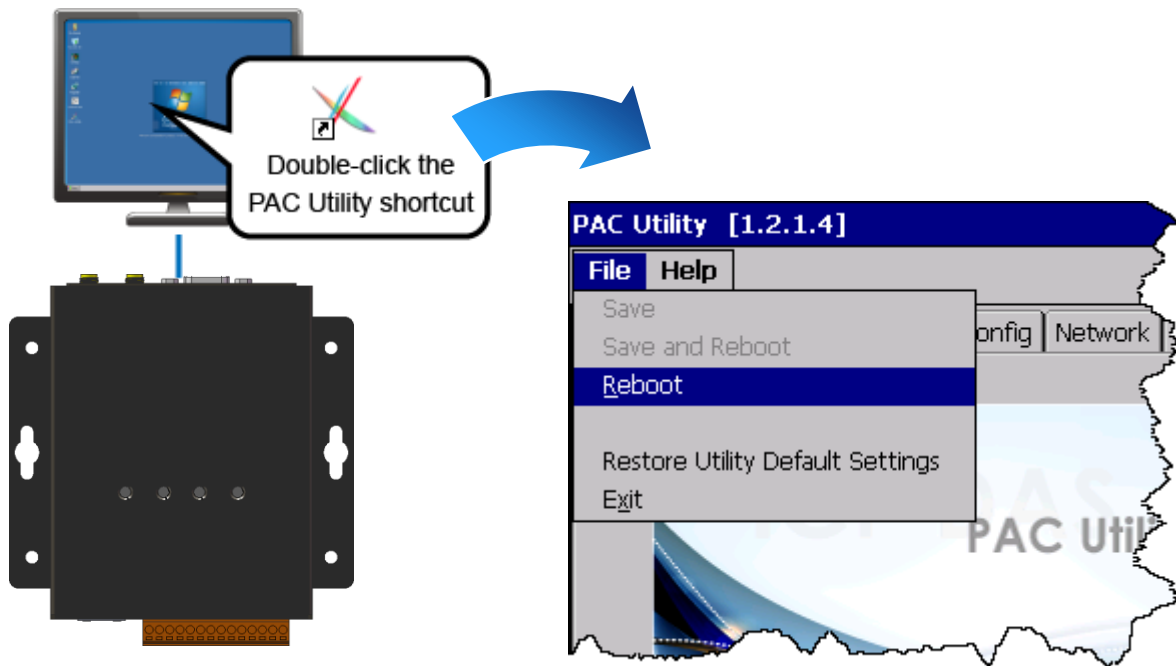

6 Using PAC Utility to Manage the WP-5231PM-3GWA-CE7

- 1) Run the PAC Utility to configure IP address (DHCP), FTP Server, Auto Execution files..., etc
- 2) Reboot the WP-5231PM-3GWA-CE7

