



WP-2241M-CE7

User Manual

Version 1.0.1, December 2018

Service and usage information for



Written by Tunglu Yu

Edited by Anna Huang

Warranty

All products manufactured by ICP DAS are under warranty regarding defective materials for a period of one year, beginning from the date of delivery to the original purchaser.

Warning

ICP DAS assumes no liability for any damage resulting from the use of this product. ICP DAS reserves the right to change this manual at any time without notice. The information furnished by ICP DAS is believed to be accurate and reliable. However, no responsibility is assumed by ICP DAS for its use, not for any infringements of patents or other rights of third parties resulting from its use.

Copyright

Copyright © 2018 by ICP DAS Co., Ltd. All rights are reserved.

Trademark

The names used for identification only may be registered trademarks of their respective companies.

Contact US

If you have any problem, please feel free to contact us.

You can count on us for quick response.

Email: service@icpdas.com

Contents

Contents.....	3
1. Introduction.....	6
1.1. Features.....	7
1.2. Specifications.....	10
1.3. Overview.....	12
1.4. Dimensions.....	15
2. Getting Started.....	16
2.1. Mounting the Hardware.....	17
2.2. Mounting the Expansion Components/Accessories.....	19
2.2.1. Mounting the XV-Board.....	19
2.2.2. Inserting the SIM Card.....	22
2.2.3. Installing the antenna.....	23
2.3. Configuring the Boot Mode.....	24
2.4. Using PAC Utility to Manage WinPAC.....	26
2.5. Changing the User Interface Language.....	27
2.6. Using DCON Utility Pro to Configure I/O Modules.....	29
2.7. Using Dial-up Networking to Make a GPRS Connection.....	32
3. Tools and Tasks.....	36
3.1. PAC Utility.....	38
3.1.1. Menu Bar – File.....	39
3.1.2. Menu Bar – Help.....	40
3.1.3. Property Tab - General.....	41
3.1.4. Property Tab – Display.....	42
3.1.5. Property Tab – IP Config.....	43
3.1.6. Property Tab – Network.....	44
3.1.7. Property Tab – Device Information.....	47
3.1.8. Property Tab – Auto Execution.....	48
3.1.9. Property Tab – Rotary Execution.....	49
3.2. DCON Utility Pro.....	50
3.3. TaskMgr.....	51
3.4. VCEP.....	52
3.5. Remote_Display.....	53
3.6. SendToCOM.....	54

3.7.	RegEdit	55
3.8.	ISQLW35.....	56
3.9.	INotepad	57
4.	Your First WinPAC Program	58
4.1.	Preparing the Development Tools	59
4.2.	Installing WP-2241M-CE7 SDK.....	60
4.3.	First WinPAC Program in VB.NET	63
4.3.1.	Create a New Project	64
4.3.2.	Specify the Path of PAC Reference.....	67
4.3.3.	Add the Control to the Form.....	70
4.3.4.	Add the Event Handling for the Control	72
4.3.5.	Upload the Application to WinPAC	73
4.3.6.	Execute the Application on WinPAC	75
4.4.	First WinPAC Program in Visual C#	76
4.4.1.	Create a New Project	77
4.4.2.	Specify the Path of PAC Reference.....	80
4.4.3.	Add the Control to the Form.....	83
4.4.4.	Add the Event Handling for the Control	85
4.4.5.	Upload the Application to WinPAC	86
4.4.6.	Execute the Application on WinPAC	88
4.5.	First WinPAC Program in Visual C++	89
4.5.1.	Create a New Project	90
4.5.2.	Configure the Platform	95
4.5.3.	Specify the Path of PACSDK library and header files	96
4.5.4.	Add the Control to the Form.....	99
4.5.5.	Add the Event Handling for the Control	102
4.5.6.	Upload the Application to WinPAC	104
4.5.7.	Execute the Application on WinPAC	106
5.	APIs and Demo Programs	107
5.1.	PAC Standard APIs.....	108
5.1.1.	VB.NET Demo Programs for PAC Standard APIs	109
5.1.2.	C# Demo Programs for PAC Standard APIs	110
5.1.3.	Visual C++ Demo Programs for PAC Standard APIs.....	111
5.2.	PAC IO APIs.....	112
5.2.1.	VB.NET Demo Programs for PAC Standard APIs	113
5.2.2.	C# Demo Programs for PAC Standard APIs	114
5.2.3.	Visual C++ Demo Programs for PAC Standard APIs.....	115

6.	I/O Modules and SDK Selection	116
7.	WP-2241M-CE7 Updates	119
7.1.	OS Updates	120
7.1.1.	OS Updates using Eshell.....	121
7.1.2.	OS Updates using micro_SD.....	124
7.2.	SDK Updates.....	126
7.2.1.	SDK Updates for VB.NET or C#.....	127
7.2.2.	SDK Updates for C++	128
Appendix. A.	Tips – How to.....	129
A.1.	How to Online Debug the WP-2241M-CE7 Program.....	130
A.2.	How to Automatically Synchronize WinPAC Clock	135
A.3.	How to use User Account Control in WinPAC.....	137
A.3.1.	How to Create an User Account	138
A.3.2.	How to Use Telnet to remote login the WinPAC from PC.....	140
A.3.3.	How to Remove a User Account from the Login List.....	142
A.4.	How to change the battery	143
A.5.	How to Using the Practical Functions of the 3G/4G I/O Module	145
A.5.1.	How to Auto Dial 3G/4G GPRS network and redial when the network disconnected ...	146
A.5.2.	How to Use the SMS Function and Get the GPS Data	147
A.5.3.	How to Synchronize the System Time by GPS Data.....	148
Appendix. B.	XV-Board Modules.....	149
Appendix. C.	Revision History	150

1. Introduction

This chapter provides an overview of the WP-2241M-CE7 and its components, and introduces the fundamental concepts for user familiar.



The WP-2241M-CE7 are equipped a Cortex-A8 CPU (1 GHz) and running a windows CE.NET 7.0 operating system. The optional I/O expansion board, XV-board, provides high-protection I/O. Using the built-in Flash and microSD, the WP-2241M-CE7 can save application program, image file and data.

The mobile network module of WinPAC series(Except for WP-2241M-CE7) work on frequencies of WCDMA 900/2100 MHz, TD-SCDMA1900/2100 MHz, CDMA2000 (BC0) 800 MHz, FDD LTE:B1/B3/B8, TDD LTE: B38/B39/B40/B41 and GSM 850/900/1800/1900 MHz, WCDMA 2100/1900/900/850 MHz, FDD LTE:B1/B3/B5/B7/B8/B20 and GSM 850/900/1800/1900 MHz.

1.1. Features

The WP-2241M-CE7 offer the most comprehensive configuration and remote system upgrade solutions to meet specific application requirements. The following list shows the hardware and software features designed to simplify installation, configuration and application.

➤ Windows Embedded Compact 7.0



- Support PC based software: Visual Studio.NET
- Web server, FTP server, Telnet server

➤ Local I/O and Communication Expansion Board



WP-2241M-CE7 is equipped with an I/O expansion bus to support one optional expansion board, called XV-board. It can be used to implement various I/O functions such as DI, DO, A/D, D/A, Timer/Counter

For more information about these available expansion boards, please refer to

http://www.icpdas.com/root/product/solutions/hmi_touch_monitor/touchpad/xv-board_selection.html

➤ **Various Memory Expansions**

WP-2241M-CE7 provides various memory storage options, such as FRAM and microSD. Customers can choose the memory based on their characteristics.



- 16 KB FRAM: no limit on the number of write-erase cycles.
- microSD/microSDHC: to implement portable data logging applications; supports up to 32 GB.

➤ **Unique 64-bit Hardware Serial Number to Protect Your Program**

A unique 64-bit serial number is assigned to each hardware device to protect your software against piracy.



➤ **Remote I/O Module and Expansion Unit**

With the built-in RS-485 and Ethernet port, the WP-2241M-CE7 can connect RS-485/Ethernet remote I/O units (RU-87Pn/ET-87Pn) or modules (I-7000/M-7000/ET-7000).

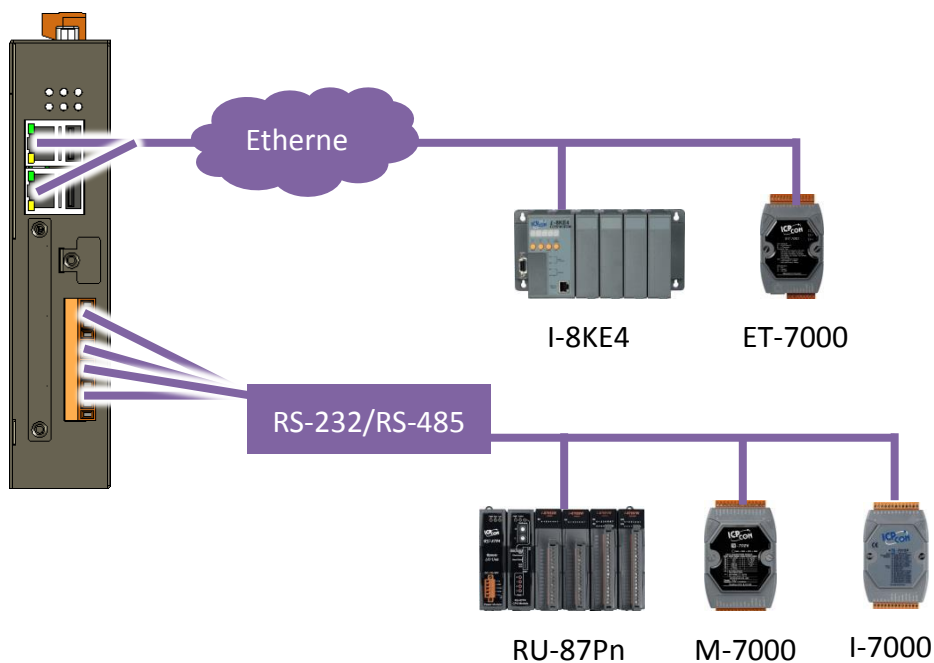

➤ **Plastic and Metal Housing**

The WP-2241M-CE7 comes with the metal casing.

➤ **Highly Reliable Under Harsh Environment**

Our WP-2241M-CE7 operates in a wide range of temperature and humidity.



- Operating Temperature: -25 ~ +75 °C
- Storage Temperature: -40 ~ +80 °C
- Humidity: 10% ~ 90% RH, non-condensing

1.2. Specifications

The table below summarizes the specifications of the WP-2241M-CE7.

System Software	
OS	Windows CE 7.0 Professional
Framework Support	.Net Compact Framework 3.5
Embedded Service	FTP Server, Web Server
SDK Provided	Dll for Visual Studio.Net 2008
Multilanguage Support	English, German, French, Spanish, Russian, Italian, Korean, Simplified Chinese, Traditional Chinese
CPU Module	
CPU	Cortex-A8, 1 GHz
DDR3 SDRAM	512 MB
Flash	256 MB
FRAM	16 KB
Expansion Flash Memory	microSD socket with one 4 GB microSD card (support up to 32 GB microSDHC card)
RTC (Real Time Clock)	Provide second, minute, hour, date, day of week, month, year
64-bit Hardware Serial Number	Yes, for software copy protection
Dual Watchdog Timers	Yes
Rotary Switch	Yes (0 to 9)
LED Indicators	1 LED for Power, 1 LED for Running, 1 LED for mobile network and 3 LEDs for user defined
VGA & Communication Ports	
Resolution	640 x 480, 800 x 480, 800 x 600, 1024 x 768
Ethernet	RJ-45 x 2, 10/100/1000 Base-TX (Auto-negotiating, Auto MDI/MDI-X, LED indicators)
USB 2.0	2
COM 1	RS-232 (RxD, TxD, and GND); Non-isolated
COM 2	RS-232 (RxD, TxD, and GND); Non-isolated
COM 3	RS-485 (Data+, Data-); Non-isolated
COM 4	RS-485 (Data+, Data-); 2500 V _{DC} isolated
I/O Expansion	
I/O Expansion Bus	Yes, one optional XV-board
Mechanical	
Dimensions (W x H x D)	35 mm x 167 mm x 119 mm
Housing	Metal
Installation	DIN-rail mounting

Environmental	
Operating Temperature	-25 °C to +75 °C
Storage Temperature	-40 °C to + 80 °C
Ambient Relative Humidity	10 % to 90 % RH (non-condensing)
Power	
Input Range	+12 V _{DC} to +48 V _{DC}
Consumption	4.8 W (0.2 A @ 24 V _{DC})



1.3. Overview

WP-2241M-CE7 is equipped with several interfaces and peripherals that can be integrated with external systems. Here is an overview of the components and its descriptions.

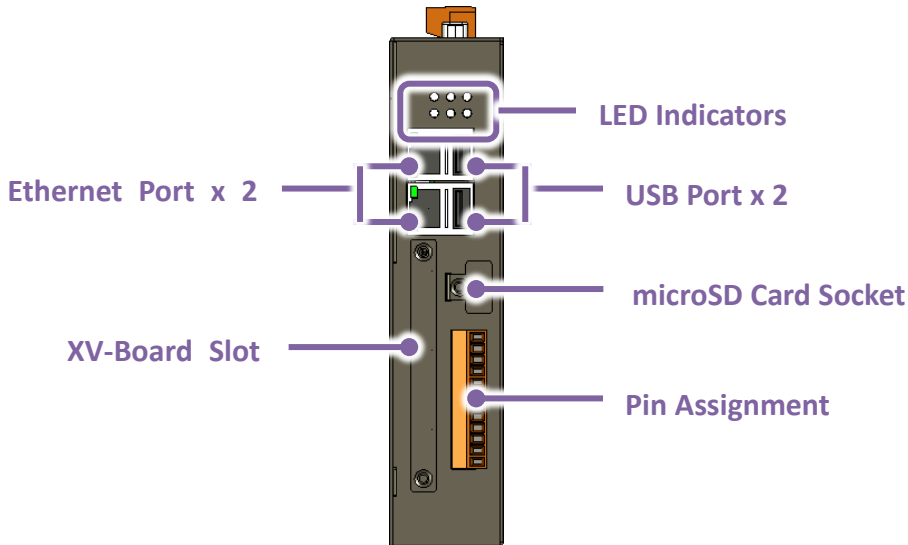
Front View

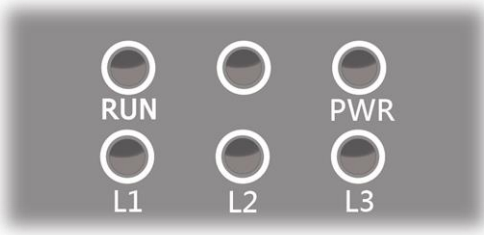

Item	Description																
LED Indicators	<p>The WP-2241M-CE7 has 6 LED indicators shown as below.</p>  <table border="1"> <thead> <tr> <th>LED Indicator</th> <th>Color</th> <th>Meaning</th> </tr> </thead> <tbody> <tr> <td>RUN</td> <td>Green</td> <td>Power on and OS is running</td> </tr> <tr> <td>PWR</td> <td>Red</td> <td>Power is on.</td> </tr> <tr> <td>L1</td> <td>Green</td> <td rowspan="3">User programmable LED indicator.</td> </tr> <tr> <td>L2</td> <td>Orange</td> </tr> <tr> <td>L3</td> <td>Red</td> </tr> </tbody> </table>	LED Indicator	Color	Meaning	RUN	Green	Power on and OS is running	PWR	Red	Power is on.	L1	Green	User programmable LED indicator.	L2	Orange	L3	Red
LED Indicator	Color	Meaning															
RUN	Green	Power on and OS is running															
PWR	Red	Power is on.															
L1	Green	User programmable LED indicator.															
L2	Orange																
L3	Red																

<p>Ethernet Port</p>	<p>The WP-2241M-CE7 has an Ethernet port that can be connected to a computer or device via an Ethernet cable.</p> <p>The Link/Act and 1G LED indicators display the status of the WP-2241M-CE7. The details are shown as below.</p>																																	
<table border="1"> <thead> <tr> <th>LED Indicator</th> <th>State (Color)</th> <th>Meaning</th> </tr> </thead> <tbody> <tr> <td rowspan="2">1G</td> <td>ON (Orange)</td> <td>Network Speed: 1 G</td> </tr> <tr> <td>OFF</td> <td>Network Speed: 10/100 M</td> </tr> <tr> <td rowspan="3">Link/Act</td> <td>ON (Green)</td> <td>The Link is active</td> </tr> <tr> <td>OFF</td> <td>The Link is inactive</td> </tr> <tr> <td>Blinking(Green)</td> <td>Network activity</td> </tr> </tbody> </table>	LED Indicator	State (Color)	Meaning	1G	ON (Orange)	Network Speed: 1 G	OFF	Network Speed: 10/100 M	Link/Act	ON (Green)	The Link is active	OFF	The Link is inactive	Blinking(Green)	Network activity	<p>USB Port</p>		<p>The WP-2241M-CE7 has two USB 2.0 port that allows support for the USB devices such as mouse, keyboard or an external USB hard drive.</p>																
LED Indicator	State (Color)	Meaning																																
1G	ON (Orange)	Network Speed: 1 G																																
	OFF	Network Speed: 10/100 M																																
Link/Act	ON (Green)	The Link is active																																
	OFF	The Link is inactive																																
	Blinking(Green)	Network activity																																
<p>microSD Card Socket</p>	<p>The microSD socket can be used to restore the WP-2241M-CE7 system and expand the memory up to 32 GB.</p>																																	
<p>XV-Board Slot</p>	<p>The XV-board slot can be used to support up to one XV-board service.</p>																																	
<p>Pin Assignment</p>	<table border="1"> <thead> <tr> <th>Pin</th> <th>Signal</th> <th>Description</th> </tr> </thead> <tbody> <tr> <td>1</td> <td>TxD</td> <td rowspan="3">COM1 (RS-232)</td> </tr> <tr> <td>2</td> <td>RxD</td> </tr> <tr> <td>3</td> <td>GND</td> </tr> <tr> <td>4</td> <td>TxD</td> <td rowspan="3">COM2 (RS-232)</td> </tr> <tr> <td>5</td> <td>RxD</td> </tr> <tr> <td>6</td> <td>GND</td> </tr> <tr> <td>7</td> <td>D+</td> <td rowspan="3">COM3 (RS-485)</td> </tr> <tr> <td>8</td> <td>D-</td> </tr> <tr> <td>9</td> <td>ISO.GND</td> </tr> <tr> <td>10</td> <td>D+</td> <td rowspan="3">COM4 (RS-485)</td> </tr> <tr> <td>11</td> <td>D-</td> </tr> <tr> <td>12</td> <td>ISO.GND</td> </tr> </tbody> </table>			Pin	Signal	Description	1	TxD	COM1 (RS-232)	2	RxD	3	GND	4	TxD	COM2 (RS-232)	5	RxD	6	GND	7	D+	COM3 (RS-485)	8	D-	9	ISO.GND	10	D+	COM4 (RS-485)	11	D-	12	ISO.GND
Pin	Signal	Description																																
1	TxD	COM1 (RS-232)																																
2	RxD																																	
3	GND																																	
4	TxD	COM2 (RS-232)																																
5	RxD																																	
6	GND																																	
7	D+	COM3 (RS-485)																																
8	D-																																	
9	ISO.GND																																	
10	D+	COM4 (RS-485)																																
11	D-																																	
12	ISO.GND																																	

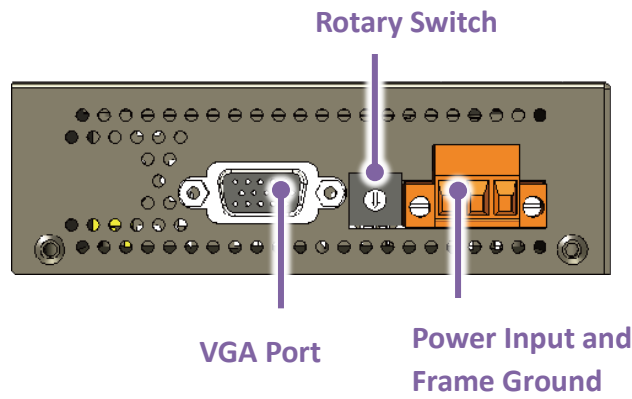

Item	Description
VGA Port	A VGA connector is a 3-row 15-pin connector that can be used with a variety of supported VGA resolutions, and the output resolution covers 640x480, 800x480, 800x600, 1024x768.
Rotary Switch	Rotary Switch is an operating mode selector switch which provides seven functions related to the selection of the operating mode.
Power Input and Frame Ground	<p>The WP-2241M-CE7 has a terminal with 3pins, there are 2 pins for power input and a pin for frame ground as follows:</p> <p>The diagram shows a yellow 3-pin terminal block. The top pin is labeled 'F.G.' with a ground symbol. The middle pin is labeled 'P.GND'. The bottom pin is labeled 'PWR' and is connected to a red line labeled 'Power Input'.</p>

1.4. Dimensions

The diagrams below provide the dimensions of the WP-2241M-CE7 to use in defining your enclosure specifications. Remember to leave room for potential expansion if you are using other components in your system.

All dimensions are in millimeters.

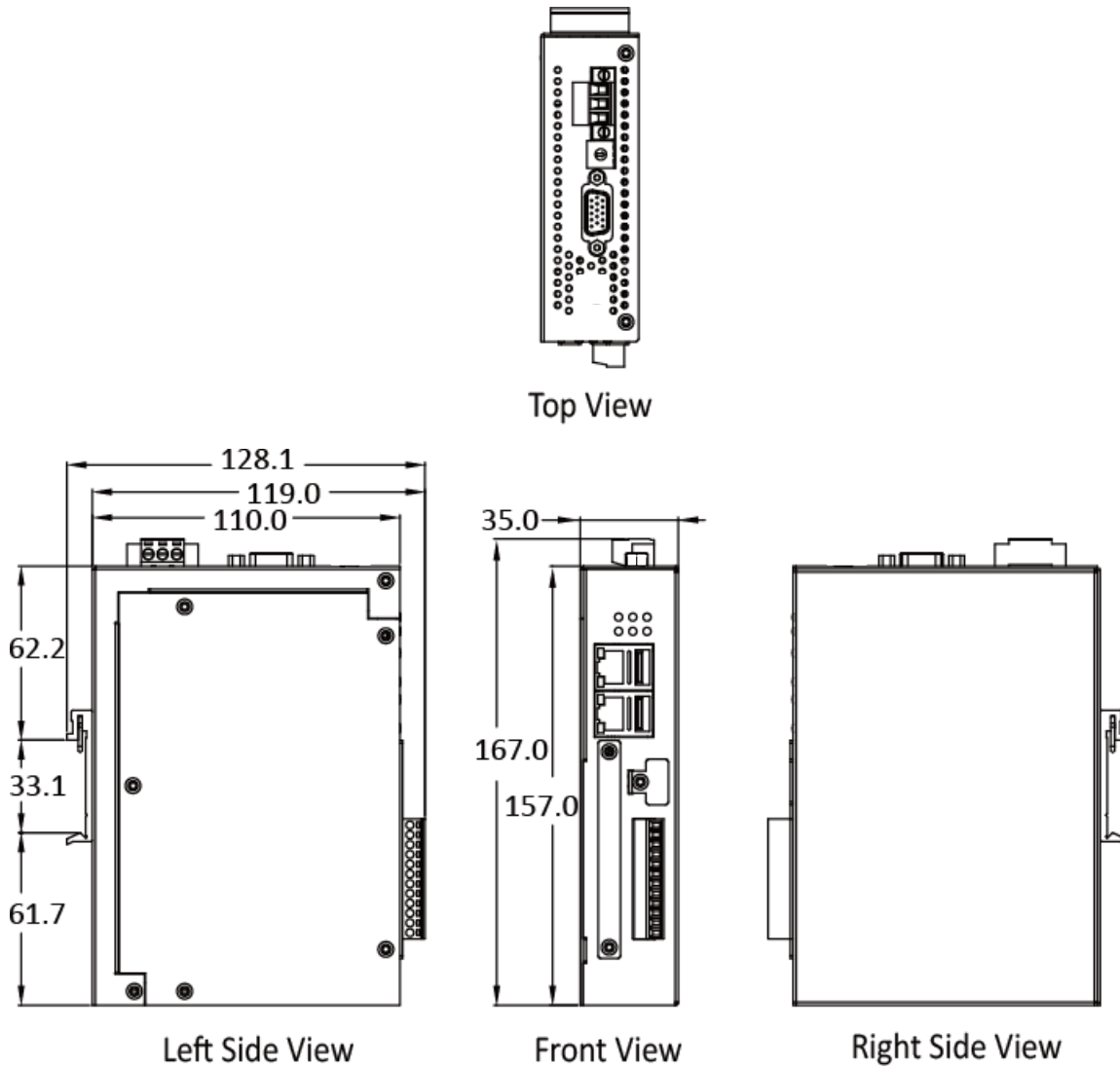

2. Getting Started

This chapter provides a guided tour of the WP-2241M-CE7 installation and configuration that describes the steps needed to download, install, configure, and run the basic procedures for user working with the WP-2241M-CE7 for the first time.

Before starting any task, please check the package contents. If any of the following package contents are missing or damaged, contact your dealer, distributor.



WP-2241M-CE7

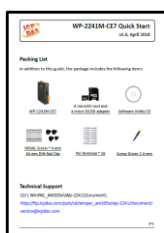

WP-2241M-CE7
Quick Start Guide



A microSD card and
a micro SD/SD adapter



Screw Driver
(1C016) 2.4 mm



44 mm DIN-Rail Clip



M3x6L Screw * 4



Wire Terminal * 16

The following items are included with mobile network expansion card



GSM/GPRS External
Antenna (ANT-421-04)



GPS Active External
Antenna (ANT-115-03)

2.1. Mounting the Hardware

The WP-2241M-CE7 has simple rail clips for mounting reliably on a standard 44 mm DIN rail.

Step 1: Mounting WP-2241M-CE7 onto a 44 mm DIN rail

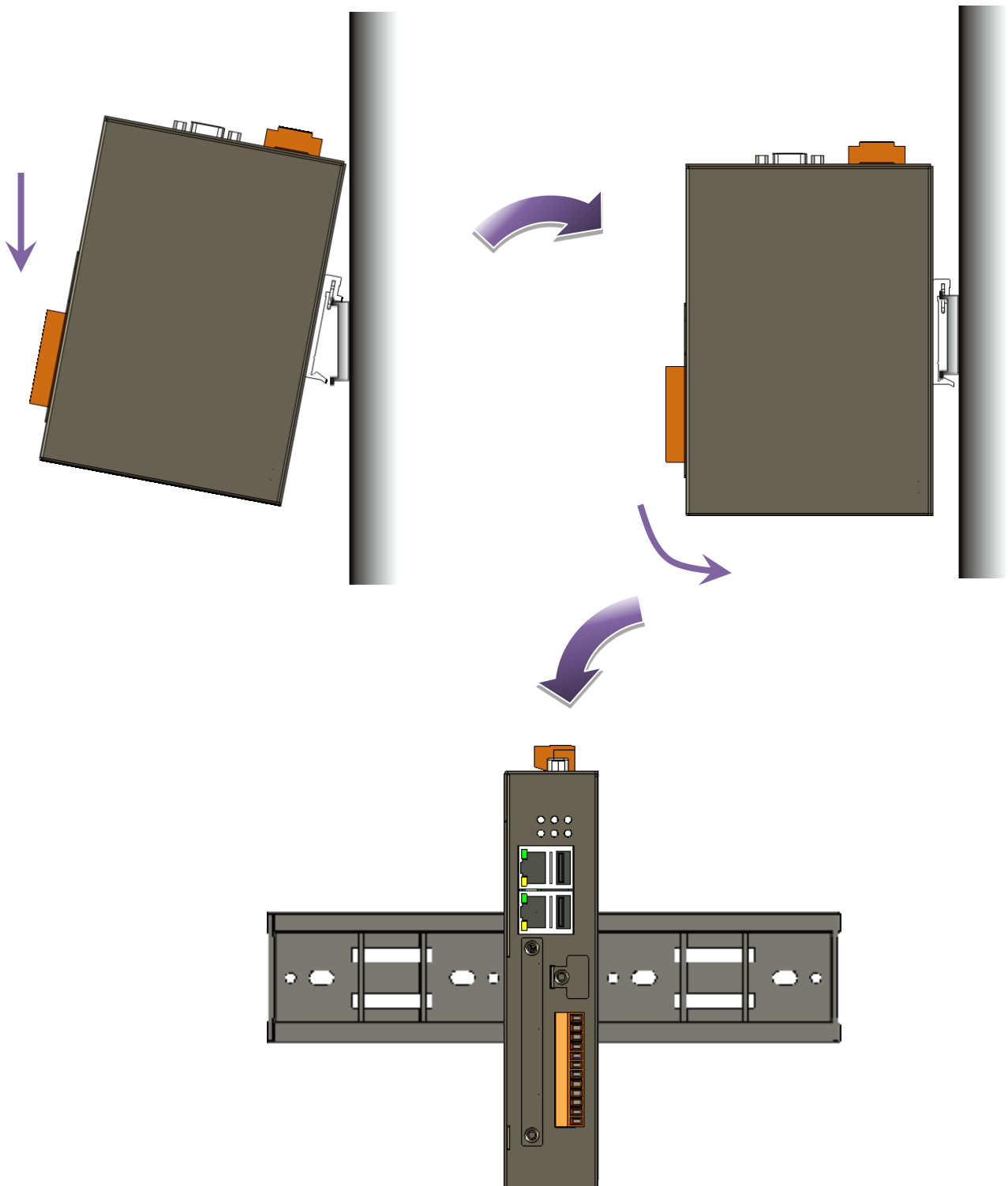

Step 2: Connecting to a PC, the USB device, and the power supply

- i. Connect the mouse or keyboard to the USB port.
- ii. Connect PC to the Ethernet port through an Ethernet switch.
- iii. Connect the power supply (+12 to +48 VDC) to PWR and P.GND terminals.
- iv. Connect the monitor to the VGA port.

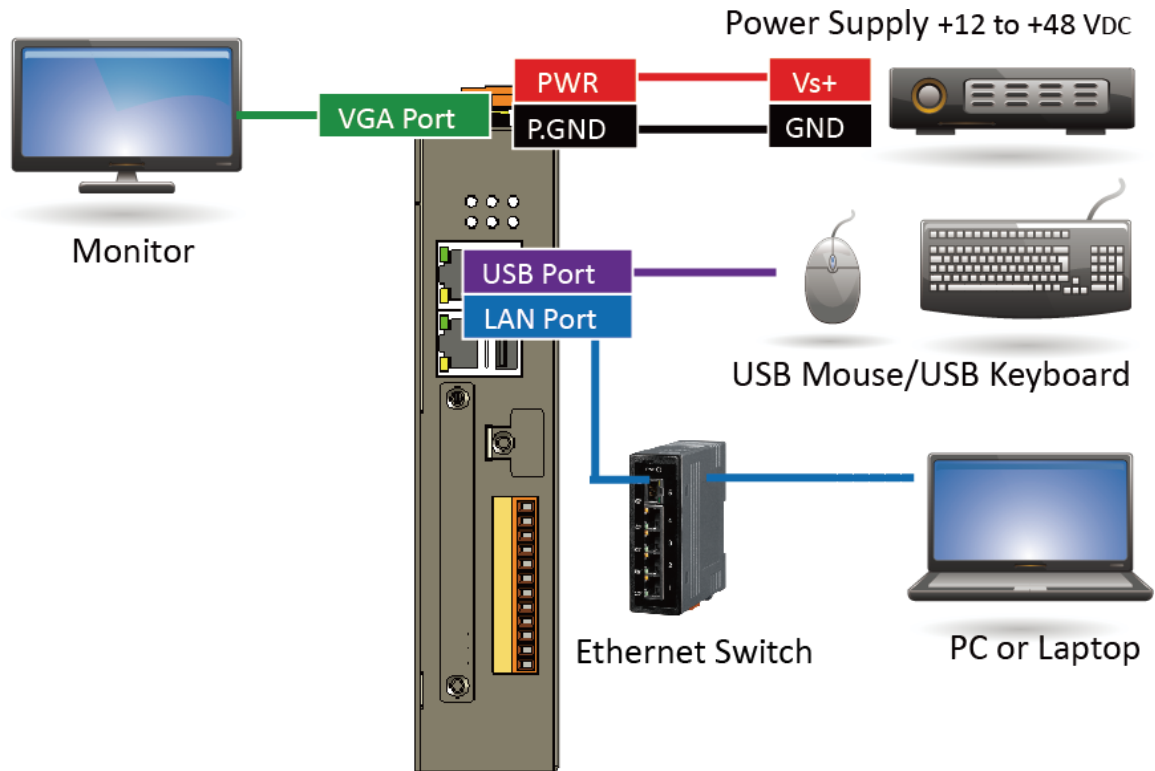

2.2. Mounting the Expansion Components/Accessories

2.2.1. Mounting the XV-Board

WP-2241M-CE7 has one expansion I/O slots to expand the functions. For more detailed information about the XV-board specifications, please refer to Appendix B. XV-Board Modules.

Step 1: Remove stripped screws and then remove the cover

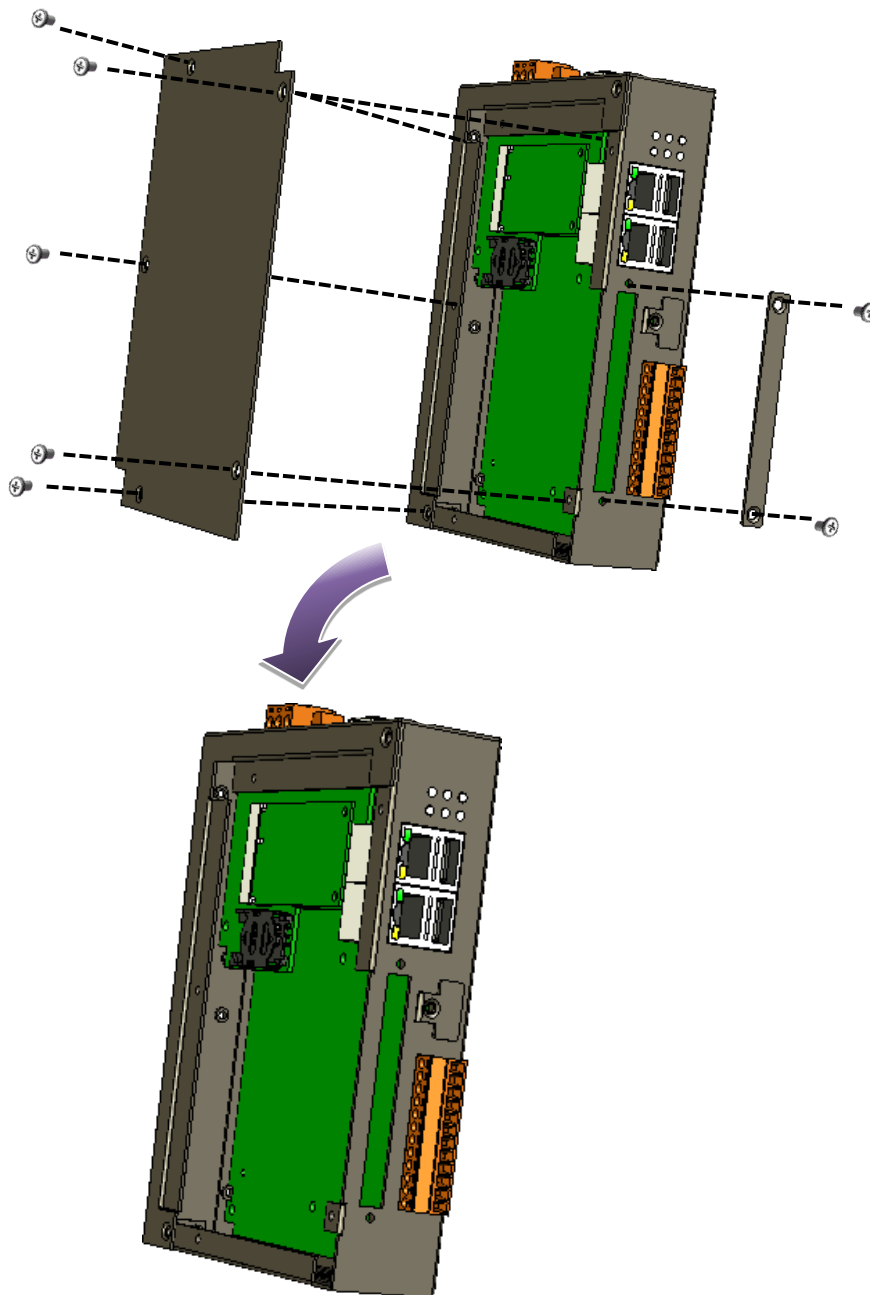

Step 2: Hold the XV-board vertically and align the socket, and then carefully press the XV-board onto the socket

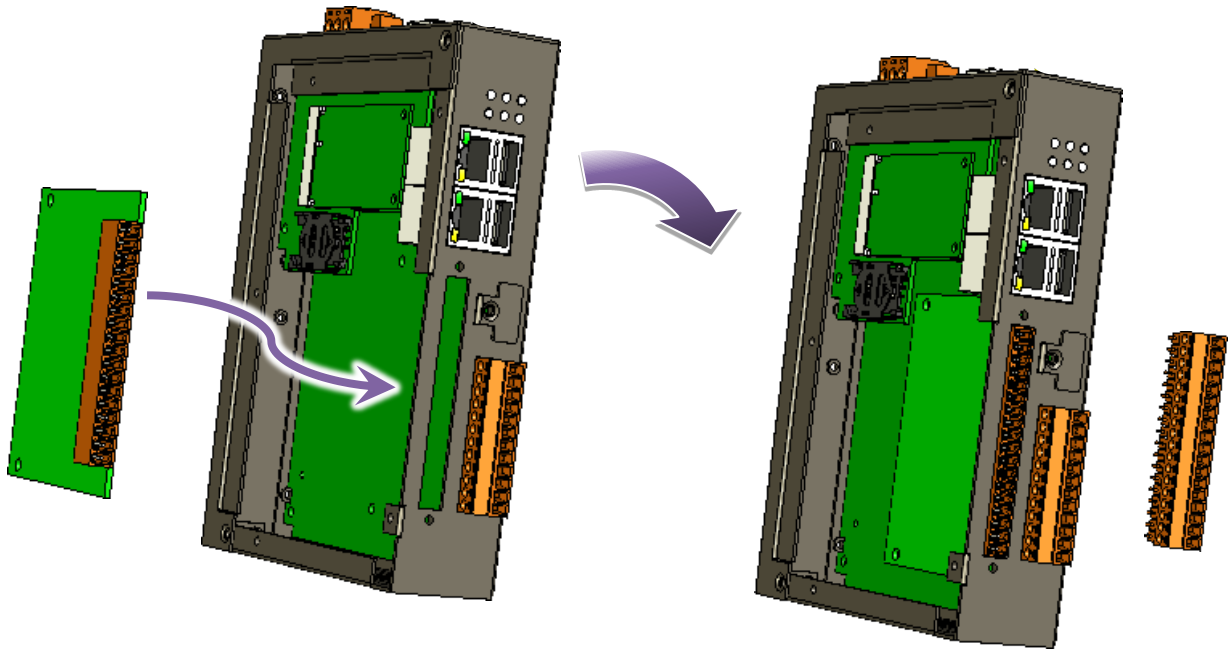

Step 3: Close the cover and then fasten the screws

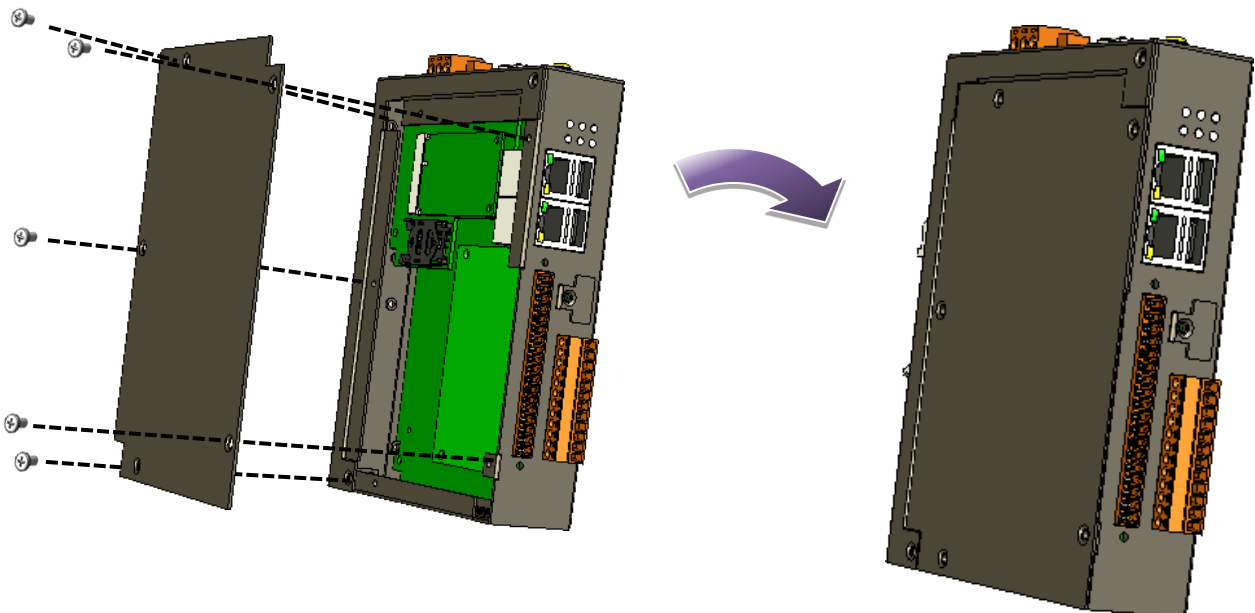

Step 4: Insert the I/O terminal

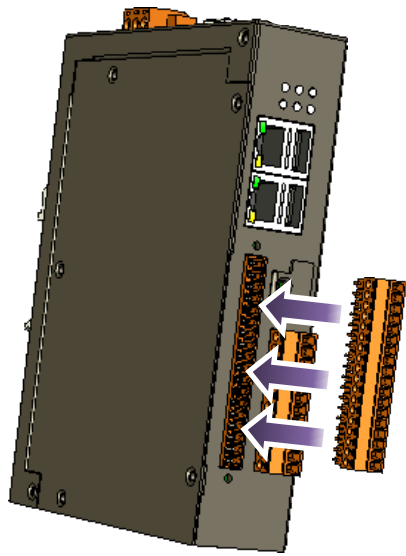

2.2.2. Inserting the SIM Card

(for Mobile network expansion card had installed)

The SIM card tray is located on the top side of the module. The eject button is on the right side of the tray door.

Step 1: Remove stripped screws and then remove the cover

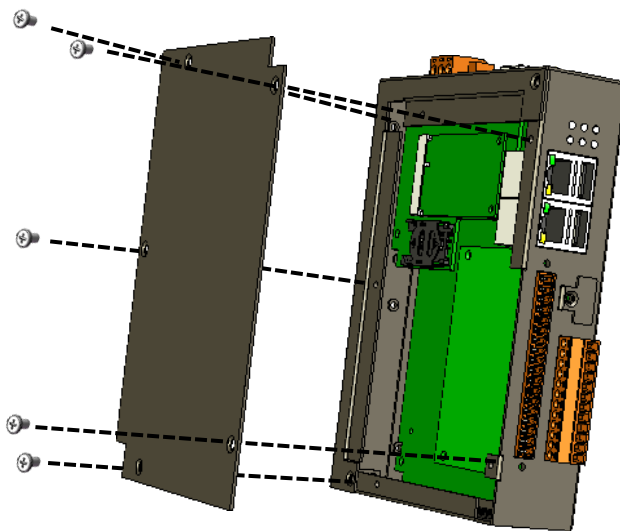

Step 2: Insert the SIM card into the Socket

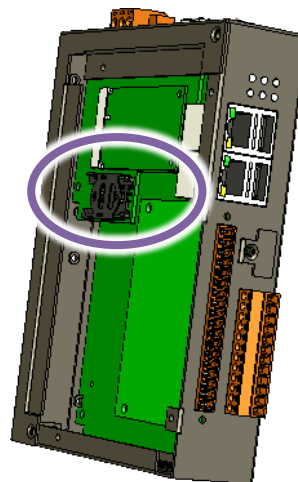

Tips & Warnings



Make sure to turn the WP-2241M-CE7 off before inserting or removing the SIM card. Do not bend or scratch the SIM card.

2.2.3. Installing the antenna

(for Mobile network expansion card had installed)

The Mobile network expansion card has an antenna connector that can be used to connect the 3G/4G antenna. To install the antenna, just screw the antenna tightly into the connector, and put the antenna in the purpose place.

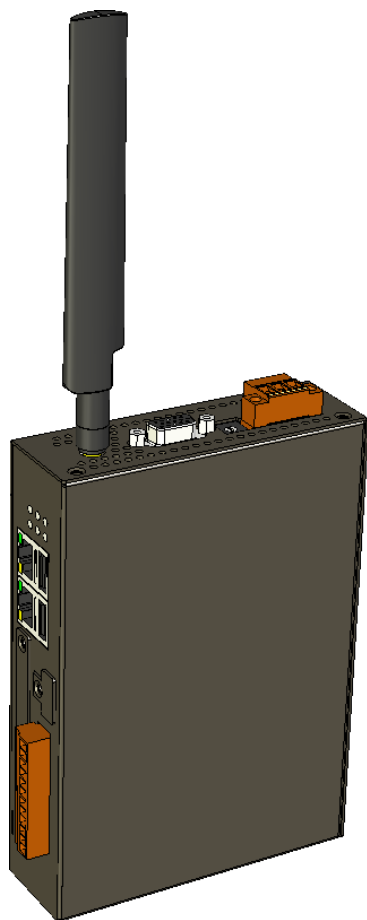

2.3. Configuring the Boot Mode

The WP-2241M-CE7 has several operating modes, which can be selected by a rotary switch.

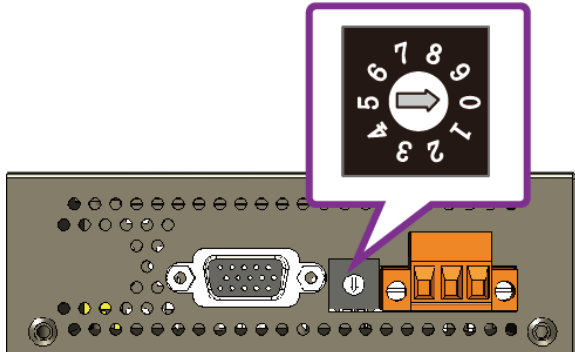

The table below lists the operation modes available with the WP-2241M-CE7.

Position	Operating Mode
0	Normal mode (Default)
1	Safe mode
2	Debug mode
3	OS update mode by Ethernet
4	Reserve
5	OS update mode by Micro_SD
6	Reserve (OS Development Mode)
7 ~ 9	User Mode

The following is a brief introduction of these modes.

Normal Mode (Default mode)

Normal mode is the default mode of operation and the one you will use most of the time. Use this mode for more tasks and configurations. Programs also are executed in this mode.

Safe Mode

Safe mode is a trouble shooting. The mode loads the minimum required device drivers and system services to boot the WP-2241M-CE7.

If you have malicious software or a program caused the WP-2241M-CE7 cannot be boot or run the normal mode, you can boot in safe mode to solve the problem.

Debug Mode

Debug mode is a special environment in which program debug functions can be used in addition to normal system functions.

Debug mode is unsupported.

OS Update Mode

OS update mode is a way used to update OS. For more information on updating the WP-2241M-CE7 OS image, please refer to section 6.1. OS updates

Reserve → OS Development Mode

The positions 4, 6, of rotary switch are reserved for OS development.

User Mode

The positions 7, 8, 9 of rotary switch are reserved for user's applications.

When WP-2241M-CE7 is boot with one of these positions, it is boot at normal mode. User's application can check the position of the rotary switch position to run at different mode.

2.4. Using PAC Utility to Manage WinPAC

The PAC Utility is a collection of the WinPAC system tool that allows user quickly and easily manage and configure the WinPAC.

For more detailed information on PAC Utility applications, please refer to “3.1. PAC Utility”

Step 1: Double-click the PAC Utility on the desktop

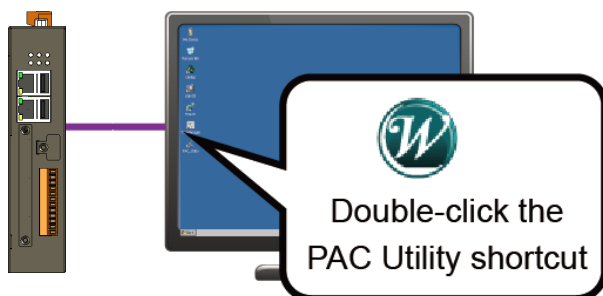

Step 2: Configure IP address (DHCP), FTP Server, Auto Execution files..., etc

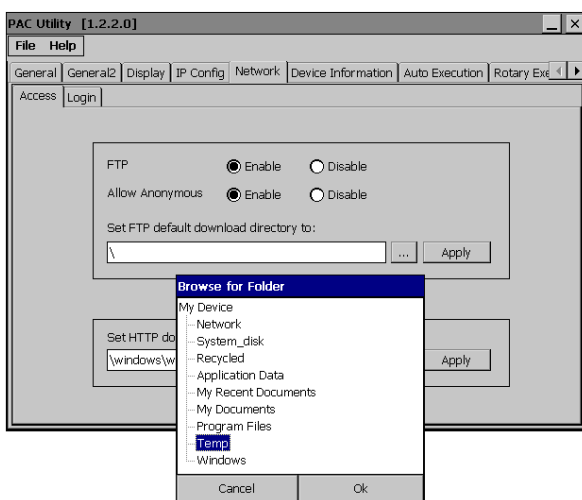

Step 3: Reboot the WP-2241M-CE7

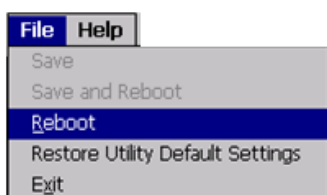

2.5. Changing the User Interface Language

The Windows CE operating system on the WP-2241M-CE7 comes with several built-in functions.

Step 1: Click Start menu, point to Settings, click Control Panel, and then click Regional Settings Options

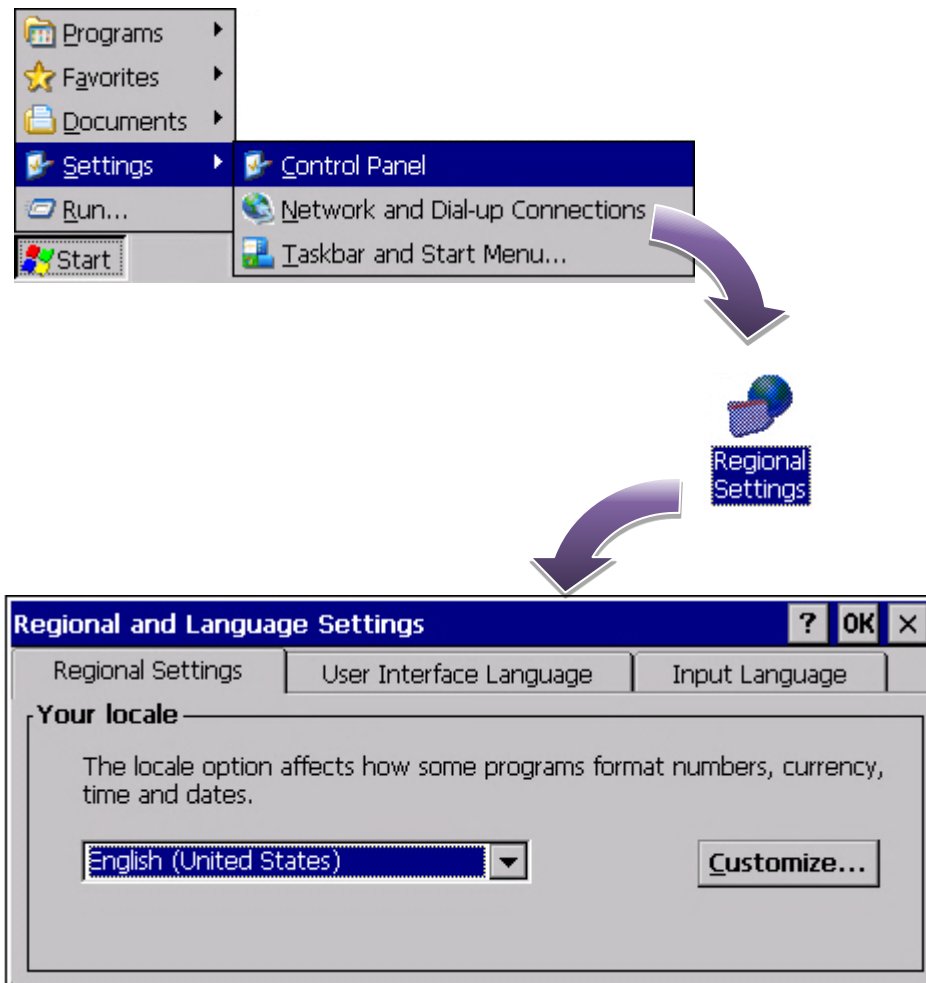

Step 2: Click User Interface Language tab, choose to your local language, and then click OK

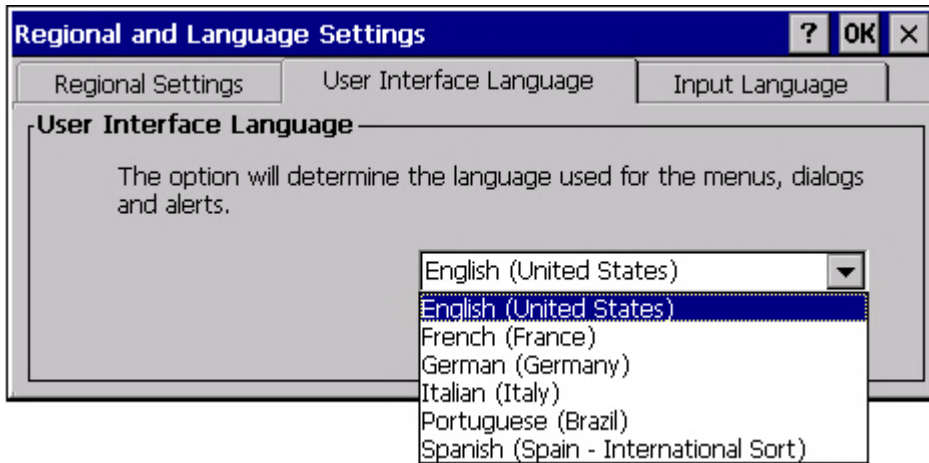

Step 3: Run the PAC Utility, and then reboot the WinPAC for changes to take effect

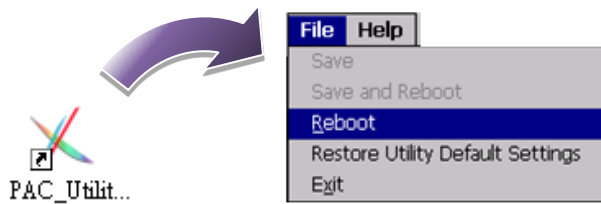

2.6. Using DCON Utility Pro to Configure I/O Modules

DCON Utility Pro enables users easily to configure and manage the I/O modules via Ethernet or serial ports (RS-232/RS-485).

Step 1: Double-click the DCON_Utility_Pro on the desktop

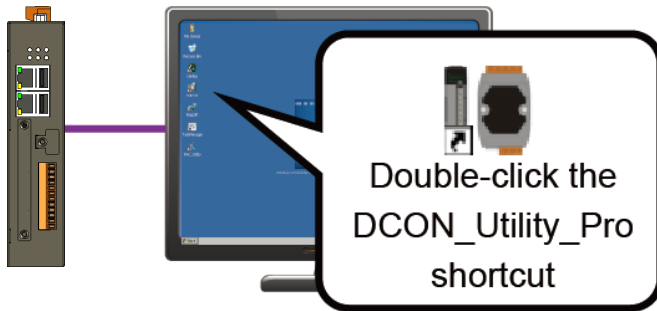

Step 2: Click the  button

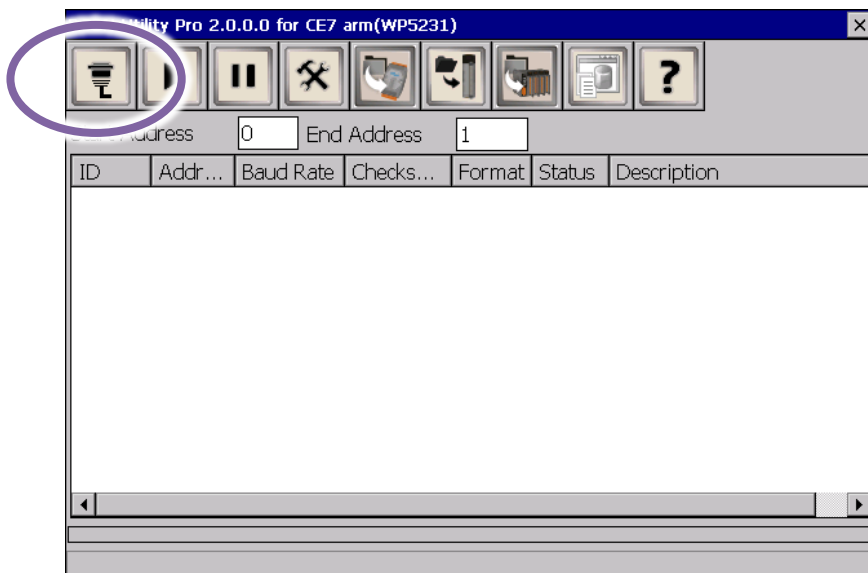

Step 3: Configure the communication settings

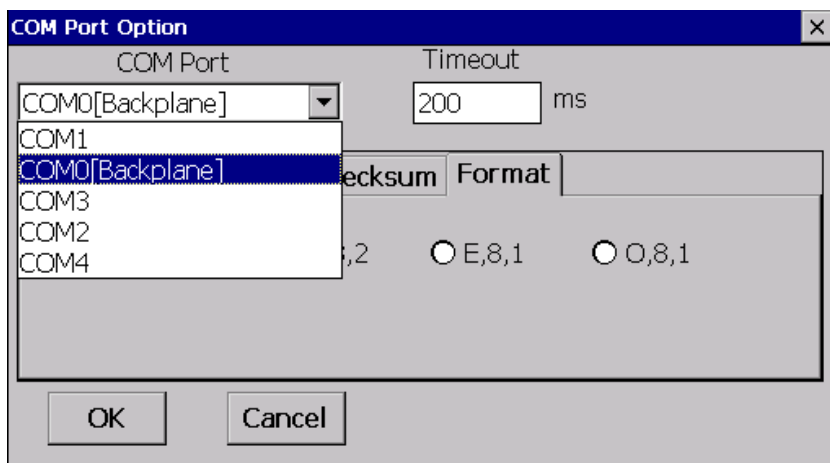

Tips & Warnings



The COM port settings for expansion I/O modules are listed below.

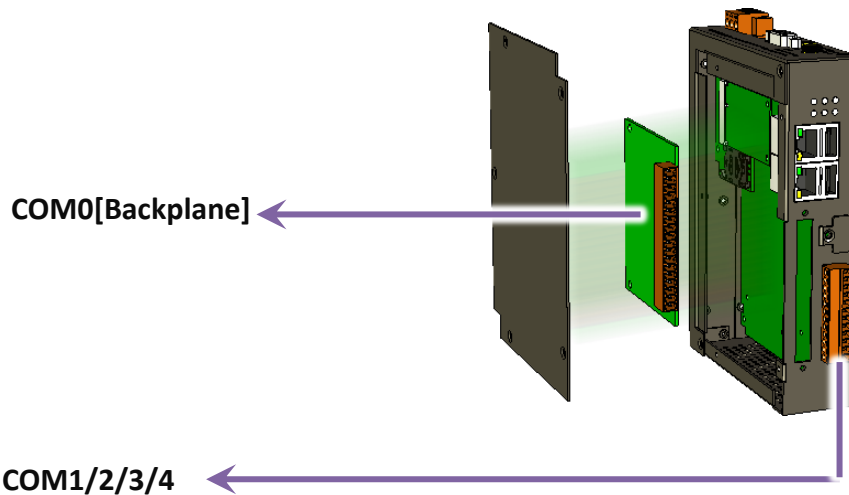

For more information on these COM port selections, please refer to the specification of the pin assignments in section 1.3. Overview

Step 4: Click the  button

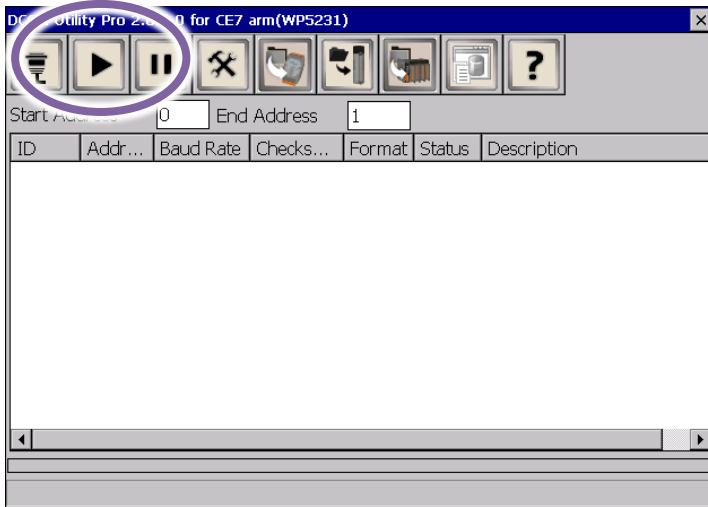

Step 5: Click the module name to configure the I/O module

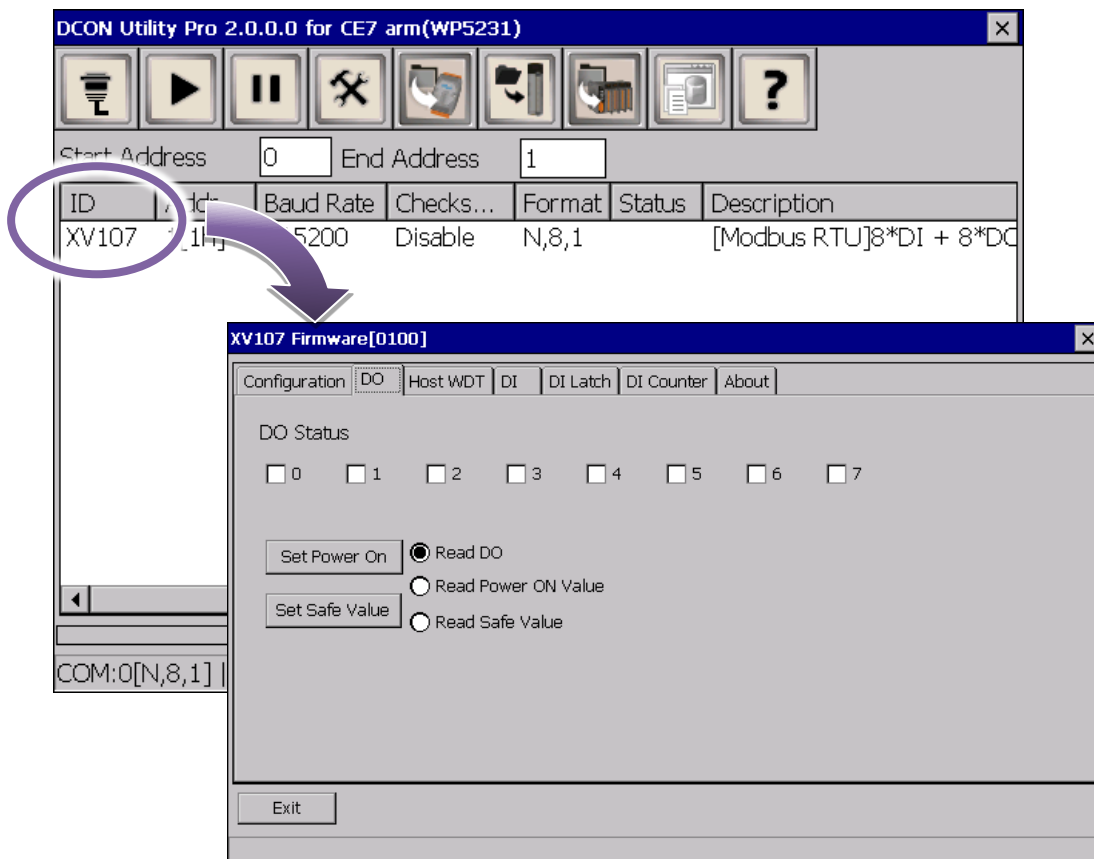

2.7. Using Dial-up Networking to Make a GPRS Connection

(for Mobile network expansion card had installed)

The Windows CE dial-up networking component driver can be efficiently used to include support for transferring data over GPRS modems in WP-2241M-CE7

Step 1: Click Start menu, point to Settings, click Network and Dial up Connections, and then click Make New Connection



Step 2: Type the name of the connection, select the Connection type as the Dialup connection, and then click Next button

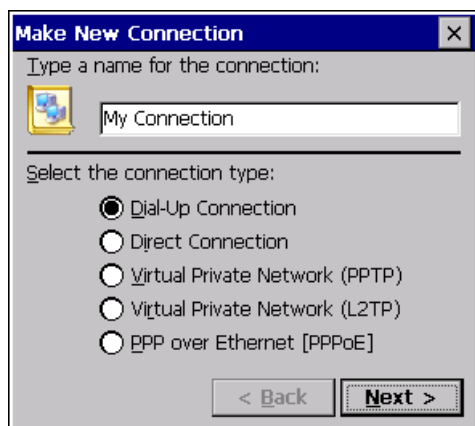

Step 3: Select USB Modem as a modem driver in the select a modem option and then click Configure button

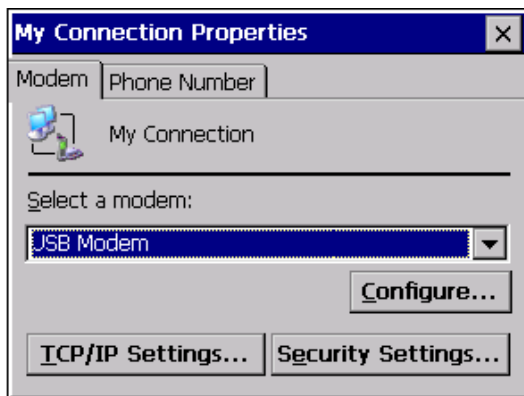

Step 4: Select 115200 in the Baud Rate option and click then click OK button

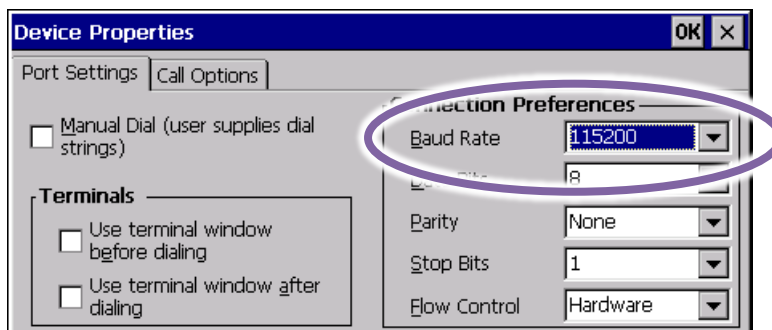

Step 5: Select Call Options tab, enter the modem dialing settings in the commands field, and then click OK button

The modem dialing settings depends on each of the telecom company. For example, the settings provided by Telecom Company in Taiwan is

+CGDCONT=1,"IP","INTERNET"

and a Telecom Company in China is

+CGDCONT=1,"IP","CMNET"

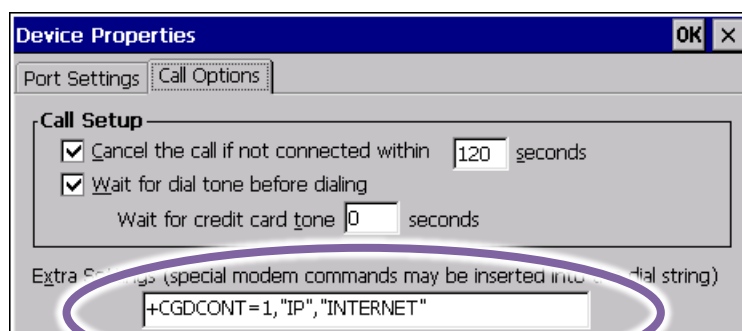

Step 6: Select Phone Number tab, enter the phone number settings in the Phone number option, and then click OK button

The phone number settings should fit the Telecom Company's setting. For example, the following setting is for Telecom Company in Taiwan.

991#**

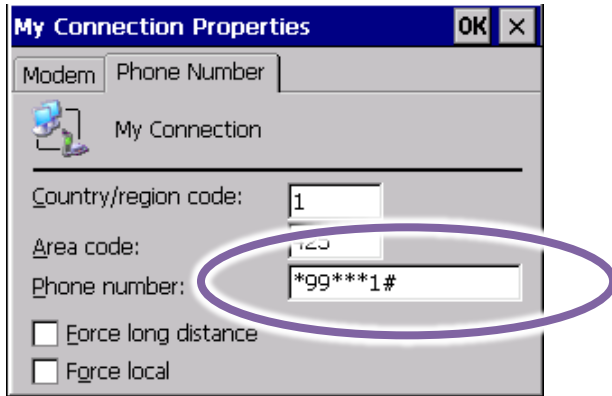

Step 7: Double-click the new connection that you have created, and enter the User name and Password, and then Click Connect button

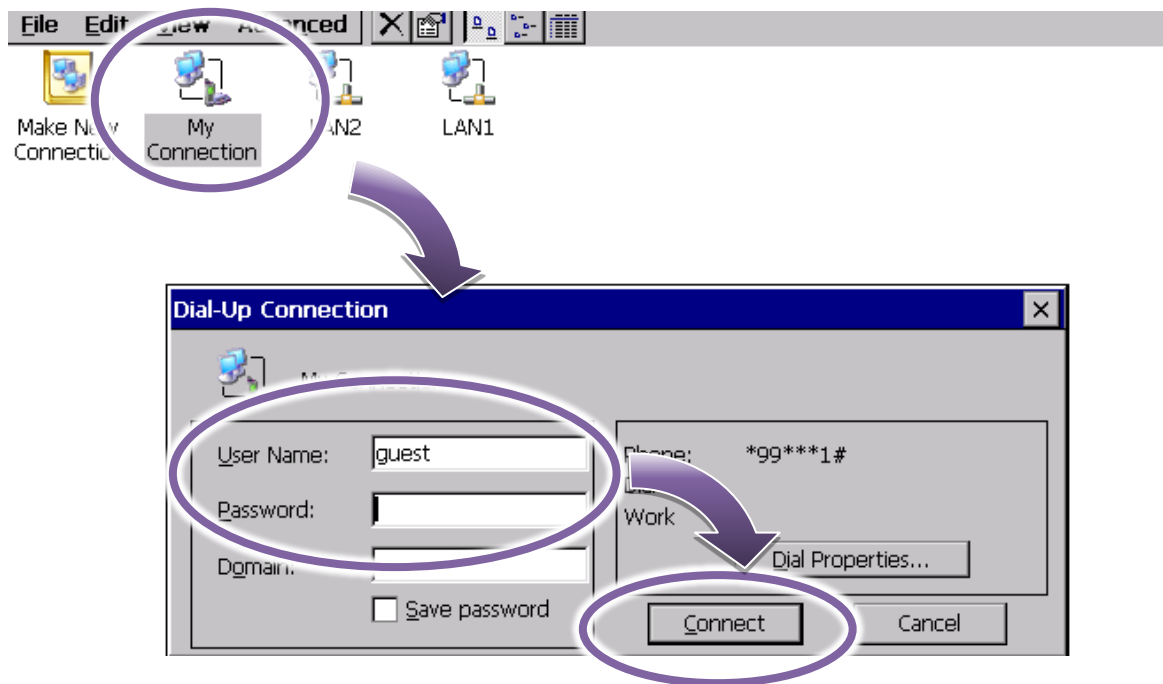

Step 8: Wait for the connection to be established

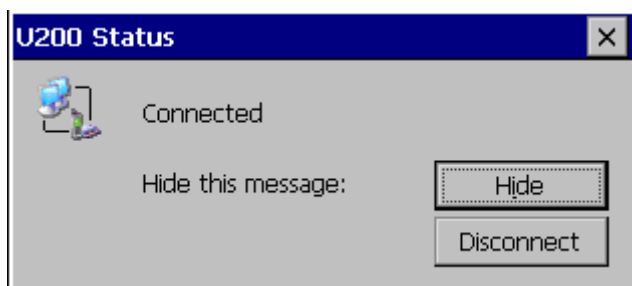

Tips & Warnings



If the connection fails, as shown below, please repeat the instructions to view the settings.

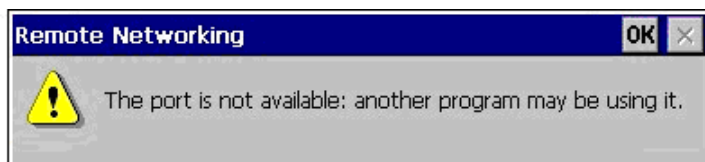

3. Tools and Tasks

This chapter provides a brief introduction of the WP-2241M-CE7 service tools and its benefits.

There are several tools and utilities built-in and designed for use with WP-2241M-CE7. Some of these are pre-installed on WP-2241M-CE7 and can work directly on WP-2241M-CE7, and some of these are supporting tools and can help you to manage the WP-2241M-CE7 remotely on a PC.

The following tools are pre-installed on WP-2241M-CE7 and can work directly on WP-2241M-CE7 that can be found by downloading the latest version from ICP DAS web site.

http://ftp.icpdas.com/pub/cd/winpac_am335x/wp-2241/system_disk/tools/

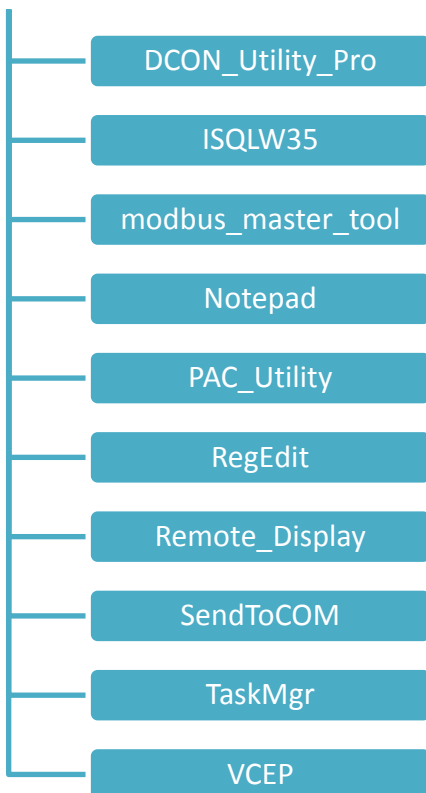

The following tools are supporting tools for remote managing the WP-2241M-CE7 used on PC that can be found by downloading the latest version from ICP DAS web site.

http://ftp.icpdas.com/pub/cd/winpac_am335x/wp-2241/pc_tools/

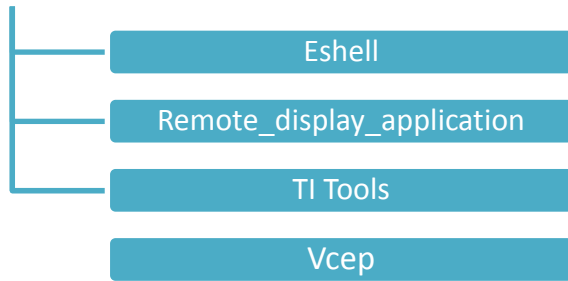

3.1. PAC Utility

PAC Utility is a collection of software applications that enable management and configuration of WinPAC system and features.

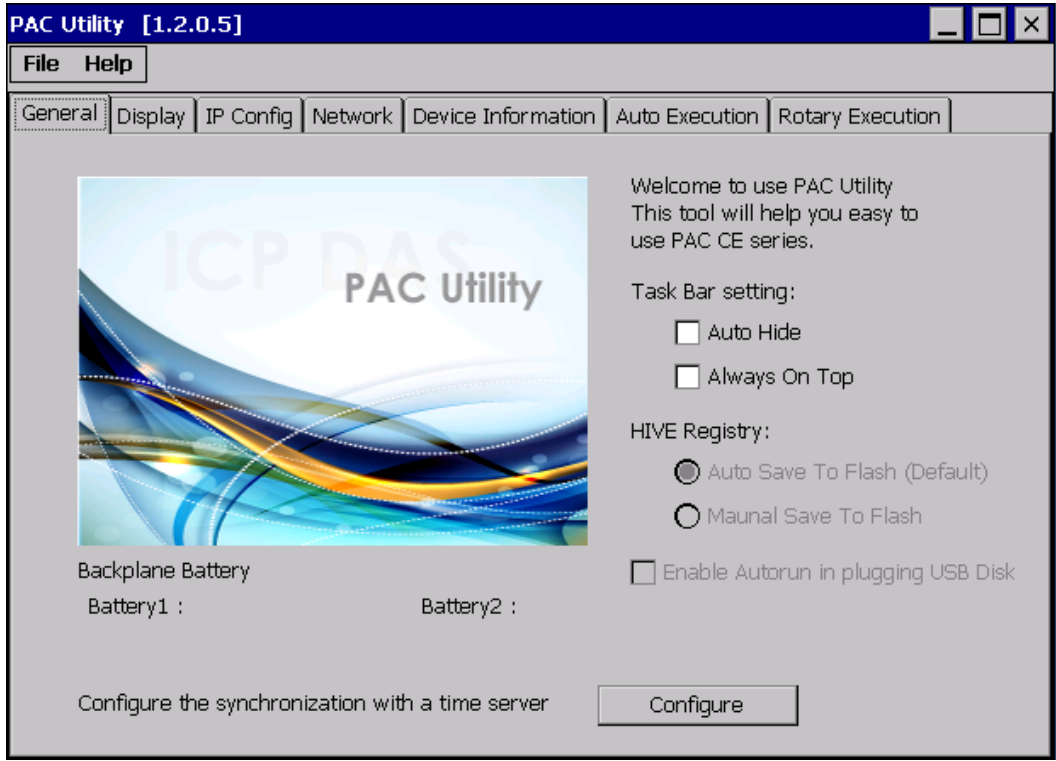

The PAC Utility includes the following menu bars and property tabs. All of these functions will be explained later.

Menu bar	Property Tab
<ul style="list-style-type: none"> • File • Help 	<ul style="list-style-type: none"> • General • Display • IP Config • Network • Device Information • Auto Execution • Rotary Execution

3.1.1. Menu Bar – File

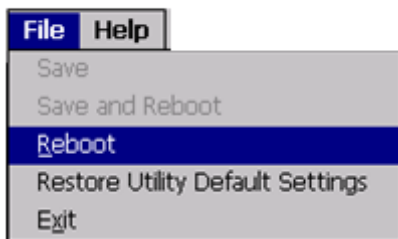

The menus use to	How to use
Reboot	Restarts the WinPAC
Restore Default Settings	Restore the settings of WinPAC to its default.
Exit	Exits the PAC Utility.

3.1.2. Menu Bar – Help

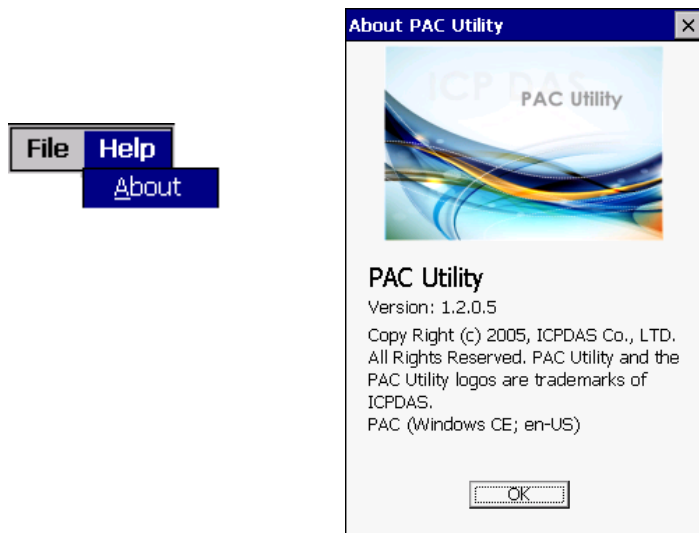

The menus use to	How to use
About	Displays a dialog box with information about PAC Utility, including the current version and copyright information.

3.1.3. Property Tab - General

The General tab provides functions to configure the task bar, check the status of the battery..., etc.

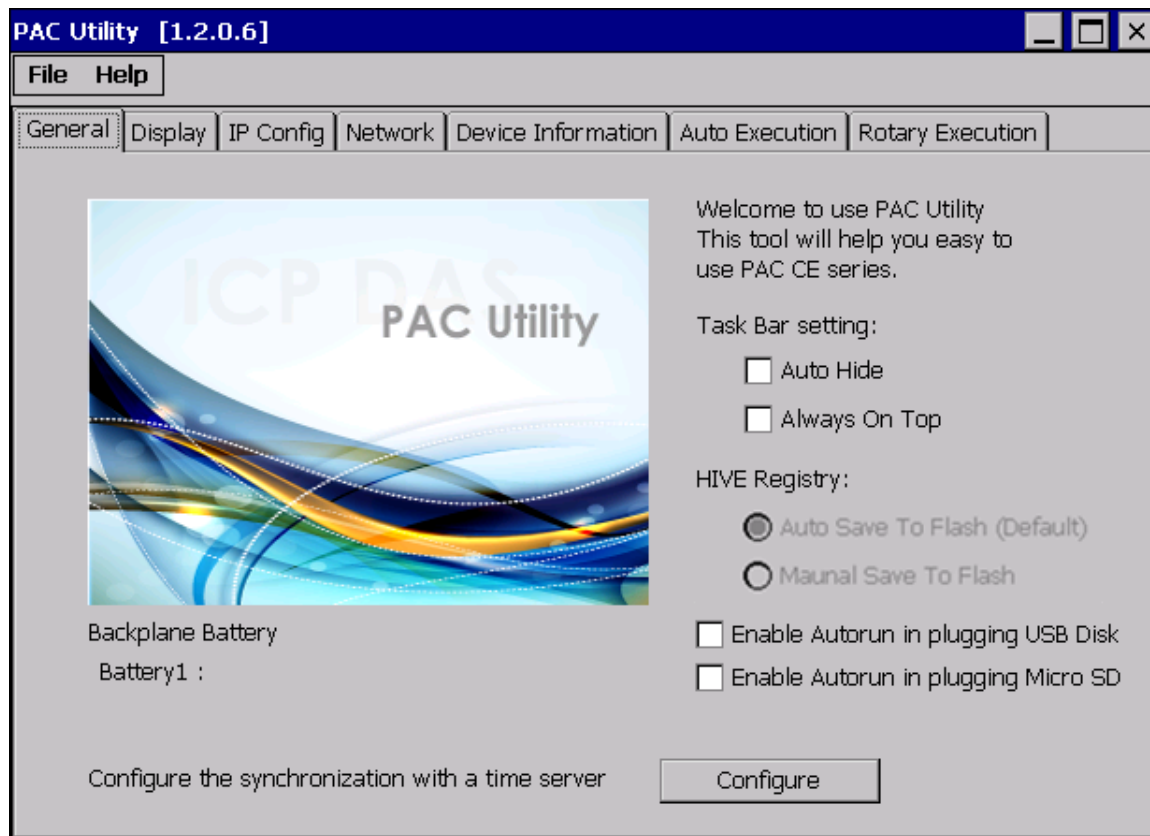

The tab use to	How to use
Lock or Auto-Hide the taskbar	<p>Auto-Hide: Select the Auto Hide check box.</p> <p>Lock: Select the Always On Top check box.</p>
Auto save or manual save to flash	<p>By default, these options are unavailable.</p> <p>Auto save to flash: This option is checked by default. Any changes made to the WP-2241M-CE7 will be saved and only take effect after the WP-2241M-CE7 reboots.</p> <p>Manual save to flash: This option is useless.</p>
Check the status of the battery	See the Battery1 field that displays the display resolution.
Automatic synchronization of system time	Refer to the Appendix A.2. How to Automatically Synchronize WinPAC Clock with an Internet Time Server.

3.1.4. Property Tab – Display

The Display tab provides functions to configure the monitor settings.

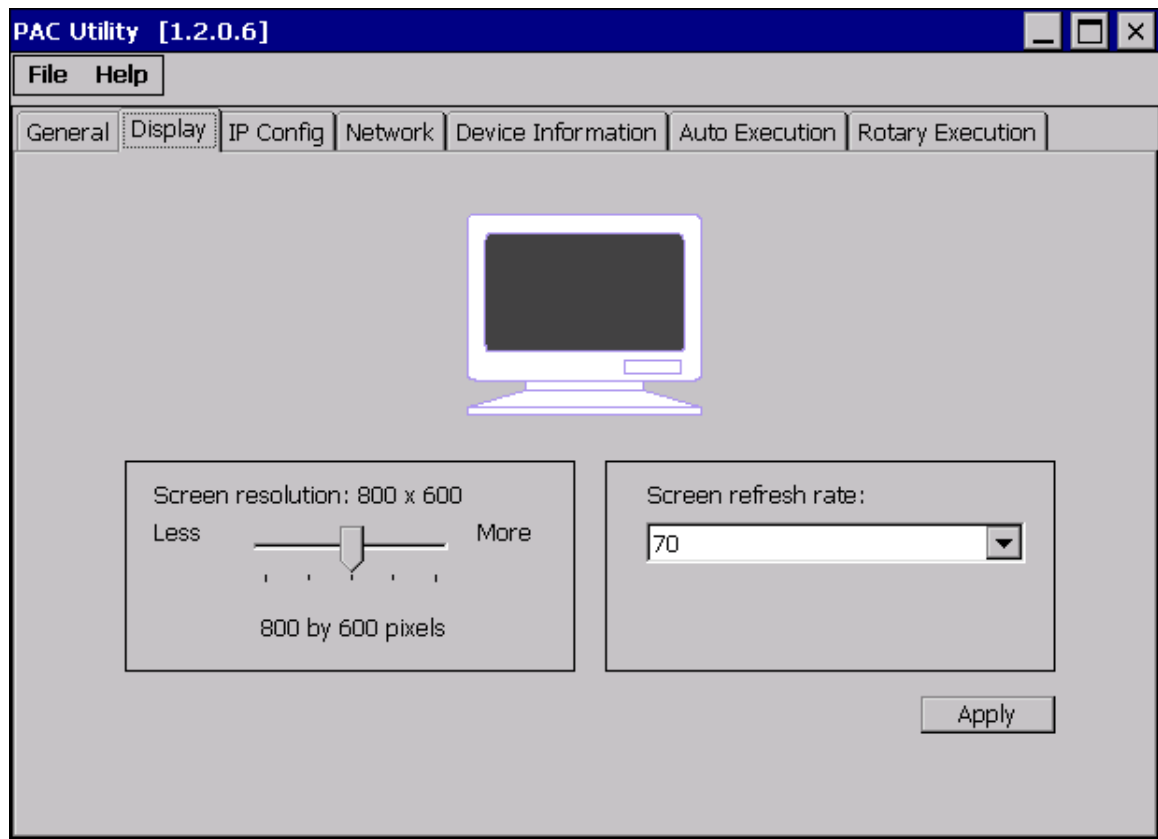

The tab use to	How to use
Adjust the screen resolution	Move the slider to the left to decrease the resolution or move the slider to the right to increase the resolution, and then click the Apply button.
Change the screen refresh rate	Select the desired refresh rate from the Screen refresh rate drop-down list, and then click the Apply button.

3.1.5. Property Tab – IP Config

The IP Config tab provides functions to configure either DHCP (Roaming) or manually configured (Static) network settings and to monitor the MAC address. Generally, DHCP is the default settings, but if you don't have a DHCP server, you must configure the network settings by using manual configuration.

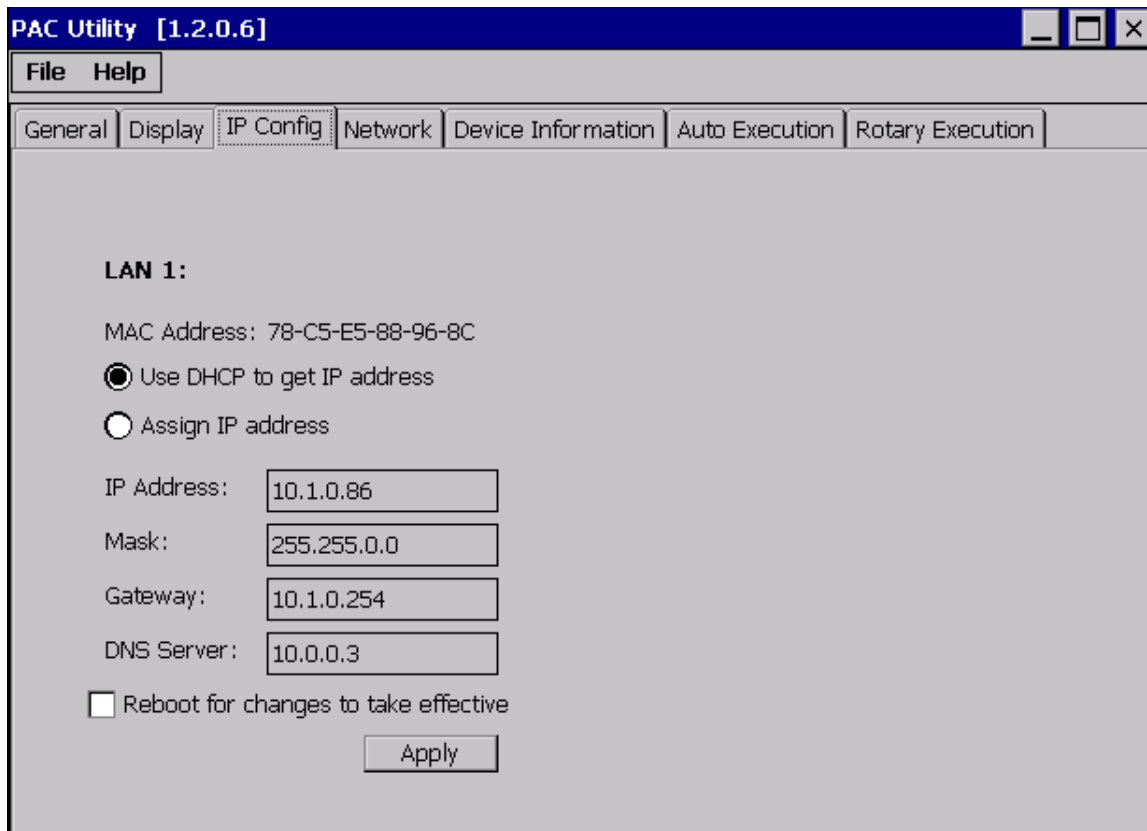

The tab use to	How to use
Set the network settings	<p>Use DHCP to get IP address: Select the Use DHCP to get IP address option, and then click the Apply button.</p> <p>Assign an IP address: Select the Assign IP address option, and then click the Apply button.</p>

3.1.6. Property Tab – Network

The Network tab comprises three tabs – Access, Login and File Server Settings.

Access

The Access tab provides functions to enable/disable the FTP access, enable/disable anonymous FTP access, and configure the FTP and HTTP directory path.

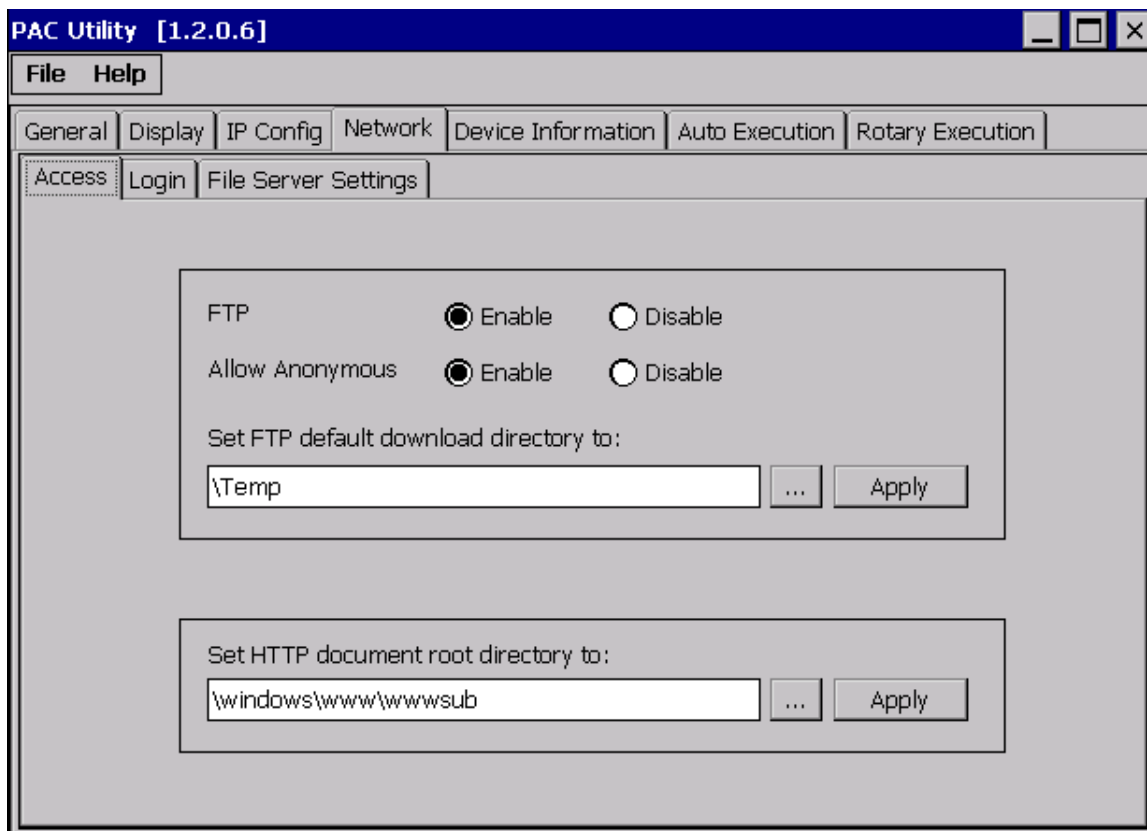

The tab use to	How to use
Enable or disable the FTP access	<p>Enable: Select the Enable check box in the FTP field, and then click the Apply button.</p> <p>Disable: Select the Disable check box in the FTP field, and then click the Apply button.</p>
Enable or disable anonymous FTP access	<p>Enable: Select the Enable check box in the Allow Anonymous field, and then click the Apply button.</p> <p>Disable: Select the Disable check box in the Allow Anonymous field, and then click the Apply button.</p>

The tab use to	How to use
Set the FTP directory path	Enter a new path in the Set FTP default download directory to: field, and then click the Apply button.
Set the HTTP directory path	Enter a new path in the Set HTTP document root directory to: field, and then click the Apply button.

Login

The Login tab provides functions to maintain the FTP accounts.

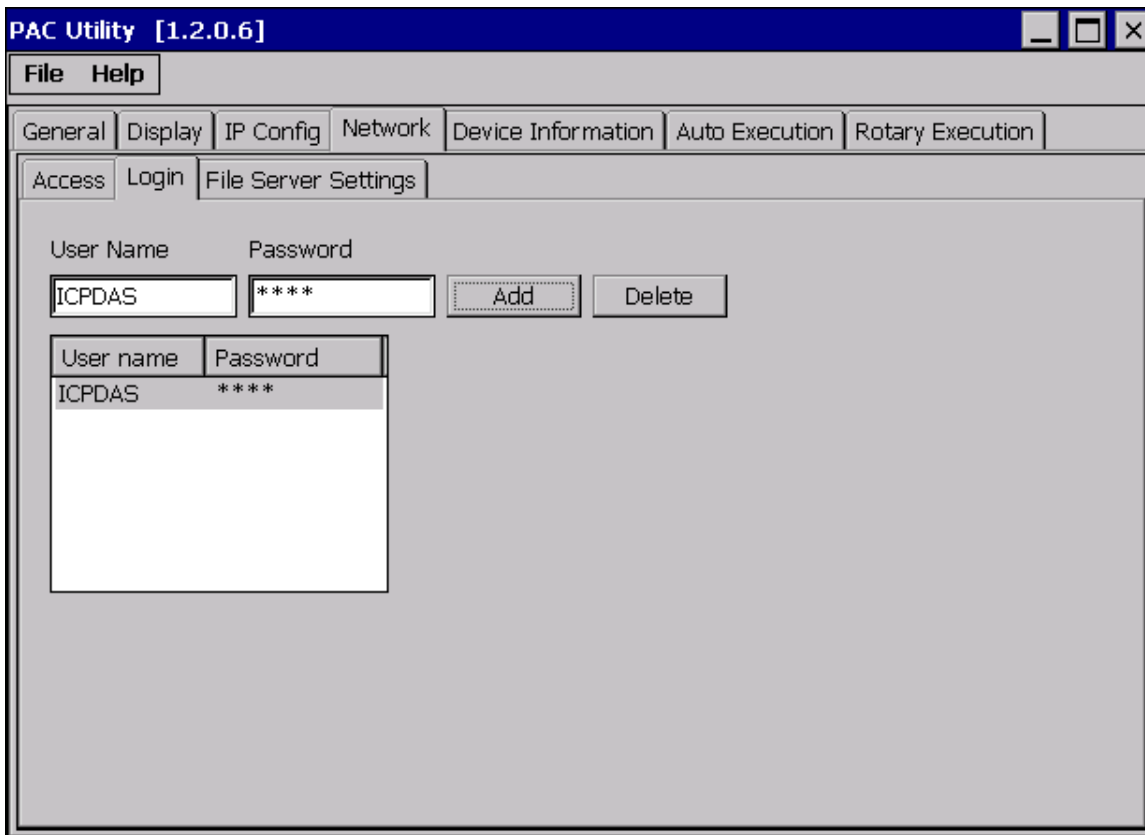

The tab use to	How to use
Maintain the FTP accounts	Refer to the Appendix C.1 How to add a user account to remote login the WinPAC from PC.

File Server Settings

The File Server Settings tab provides functions to set the SMB server.

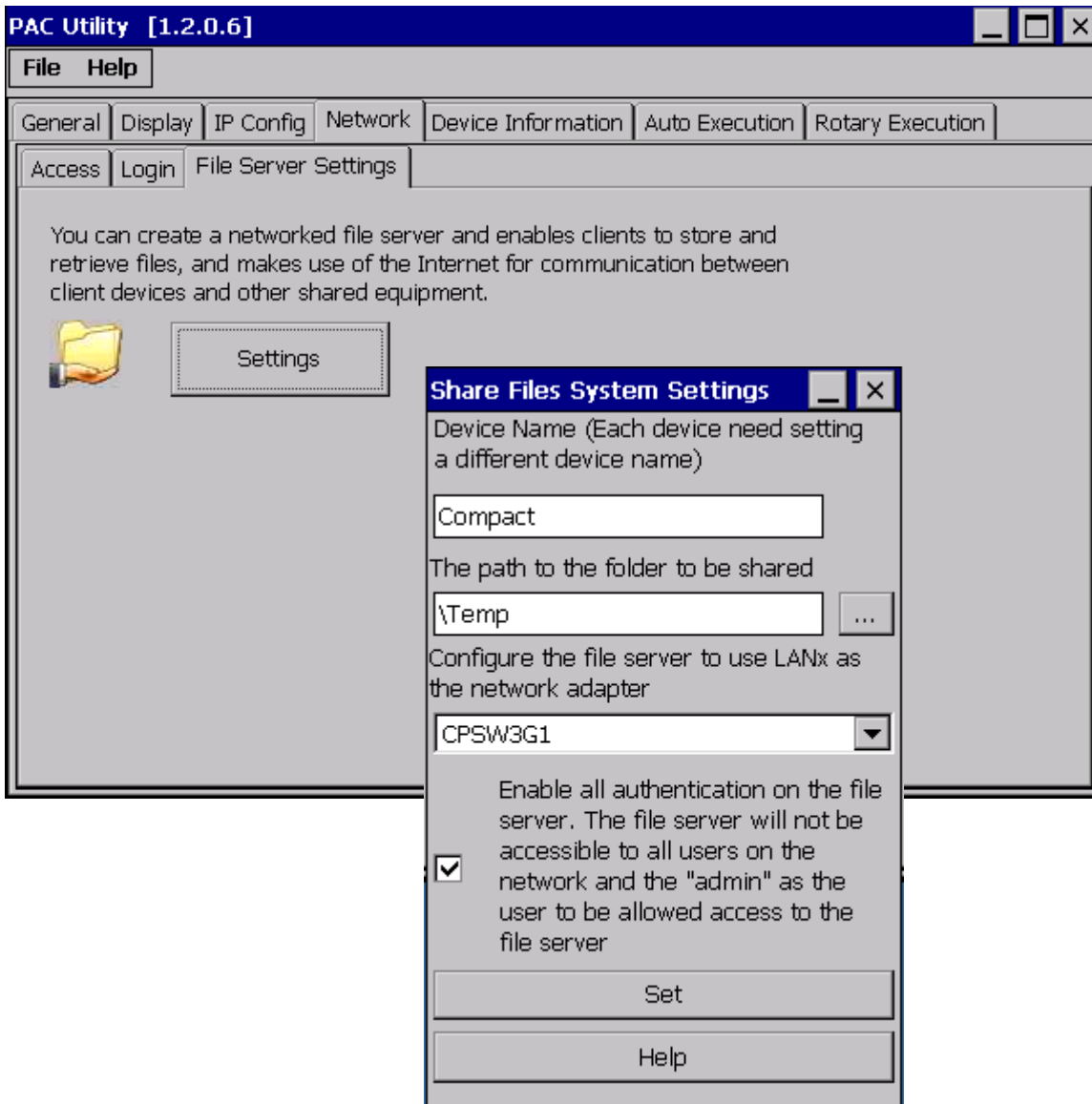

The tab use to	How to use
Set the SMB server	Click the Settings button to set the SMB server path.

3.1.7. Property Tab – Device Information

The Device Information tab provides functions to monitor necessary system information of the WinPAC. The information is the most important note of version control for upgrading system.

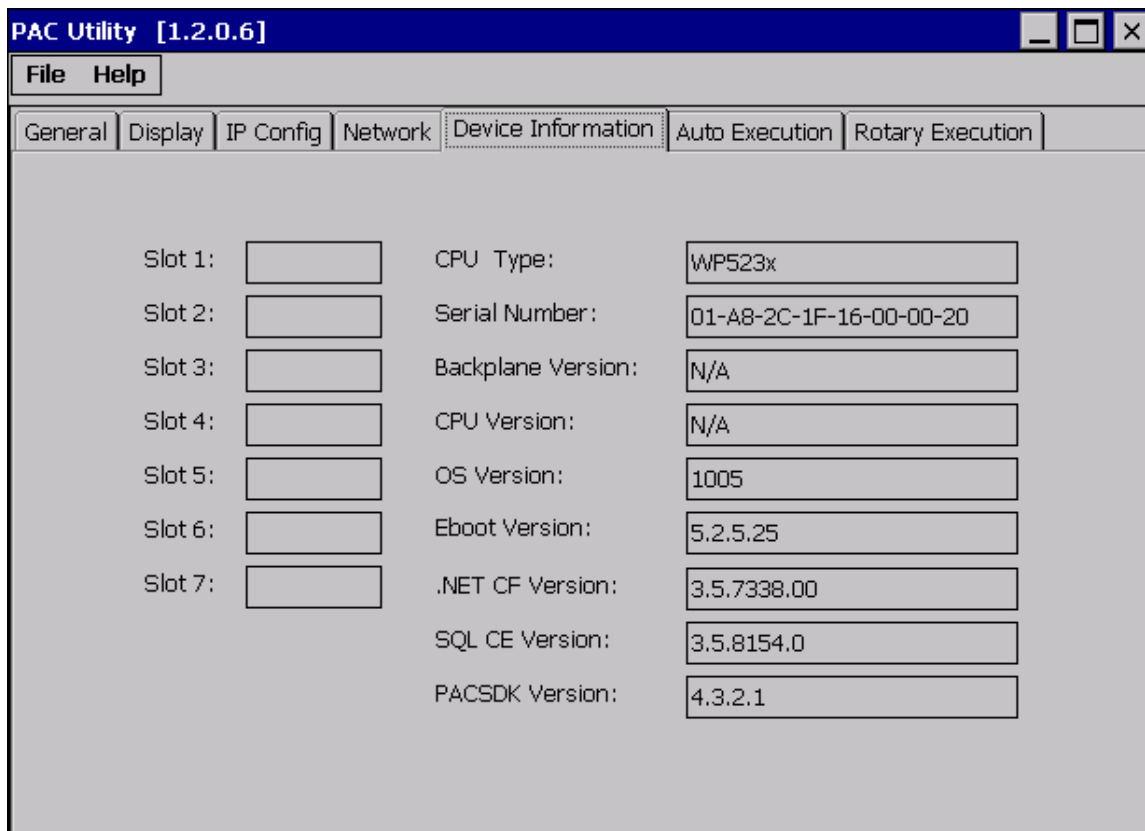

3.1.8. Property Tab – Auto Execution

The Auto Execution tab provides functions to configure programs running at WinPAC startup, it allows users to configure ten execute files at most.

Tips & Warnings



The specific extensions are .exe and .bat, and they are executed in order of program 1, program 2, etc.

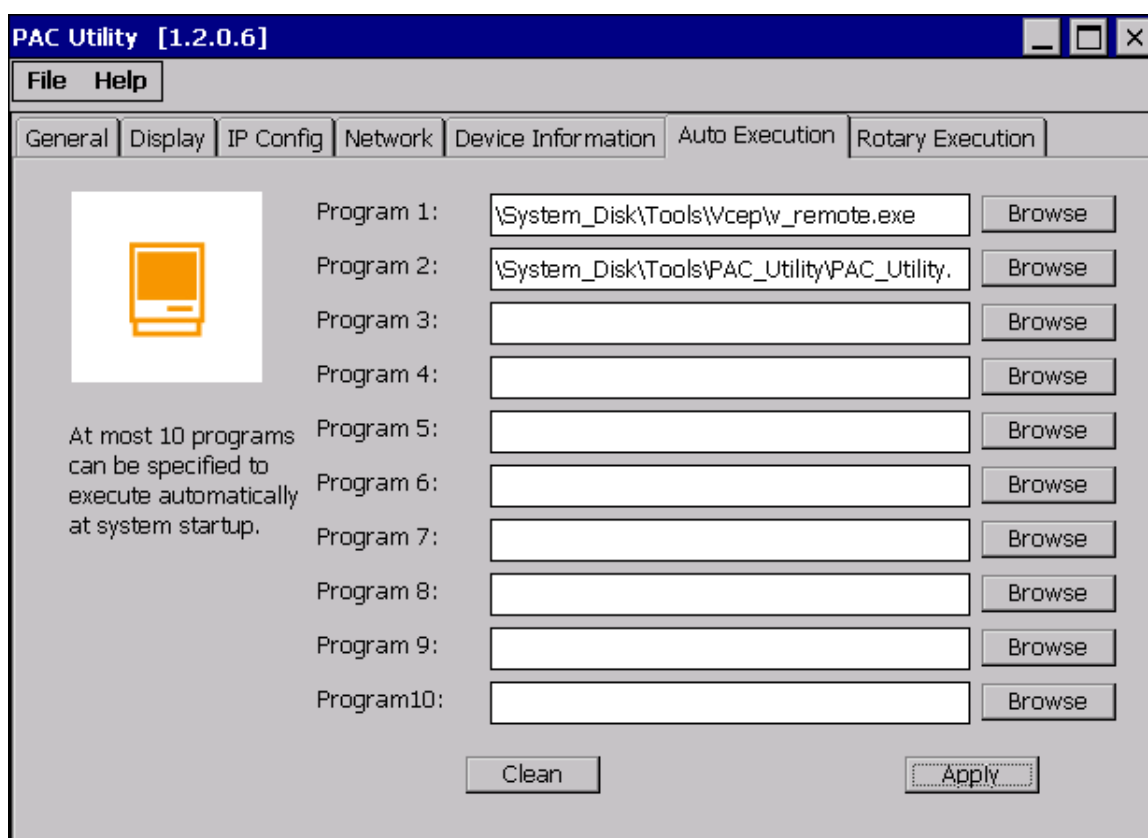

The tab use to	How to use
Configure programs running at startup	Click the Browse button to select the execute file which you want, and then click the Apply button.

3.1.9. Property Tab – Rotary Execution

The Rotary Execution tab provides functions to configure programs running at WinPAC startup in one of the user defined mode, it allows users to configure ten execute files at most.

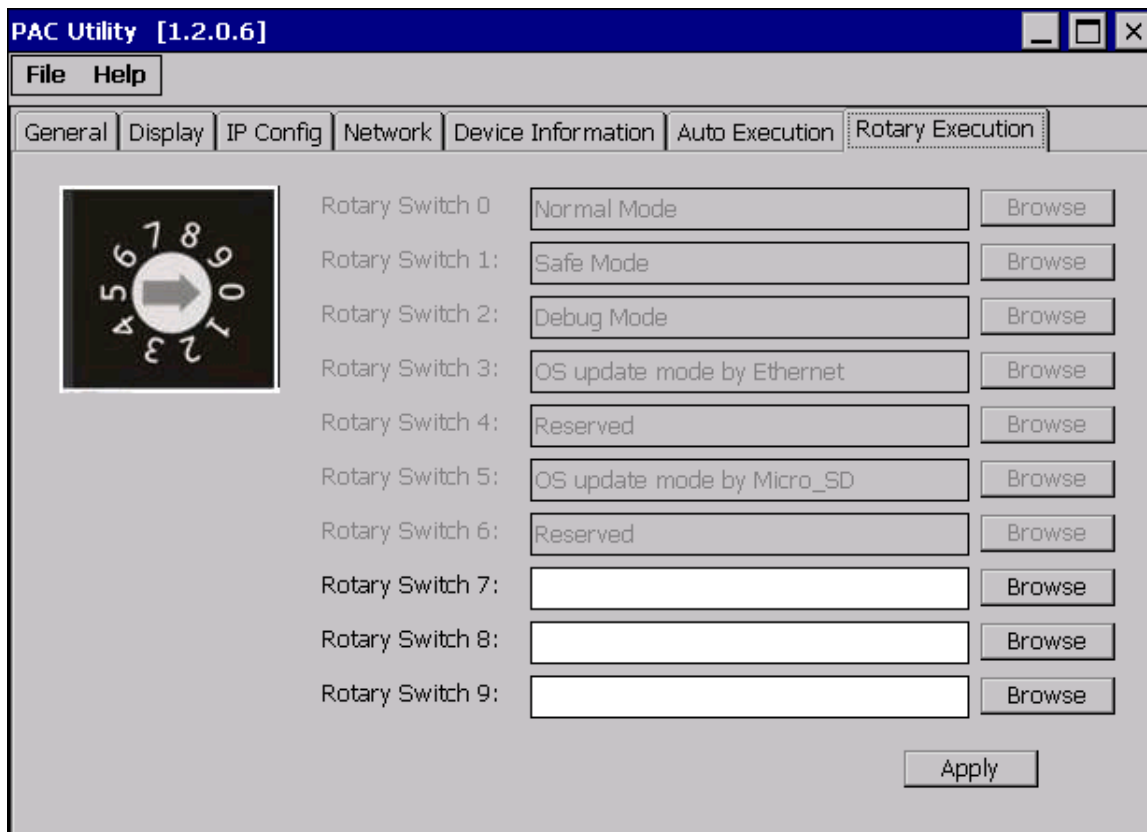

The tab use to	How to use
Configure programs running at startup in one of the user defined mode	Click the Browse button to select the execute file which you want, and then click the Apply button.

3.2. DCON Utility Pro

DCON Utility Pro enables users easily to configure and manage the I/O modules via Ethernet or serial ports (RS-232/RS-485).

For more detailed information on how to use DCON Utility Pro to configure I/O modules, please refer to “2.4. Using DCON Utility Pro to Configure I/O Modules”

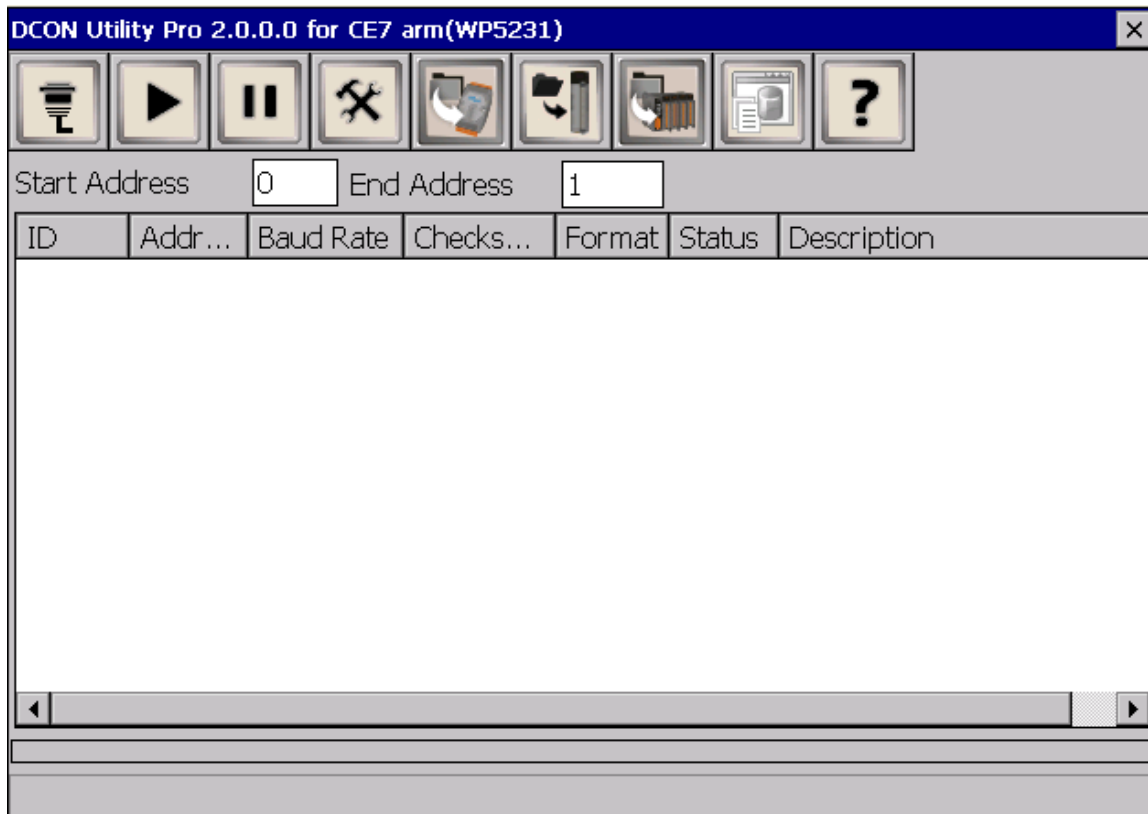

3.3. TaskMgr

The TaskMgr is a Windows CE application, which provides real time info on all processes and threads including System threads, similar in appearance to the Windows Task Manager.

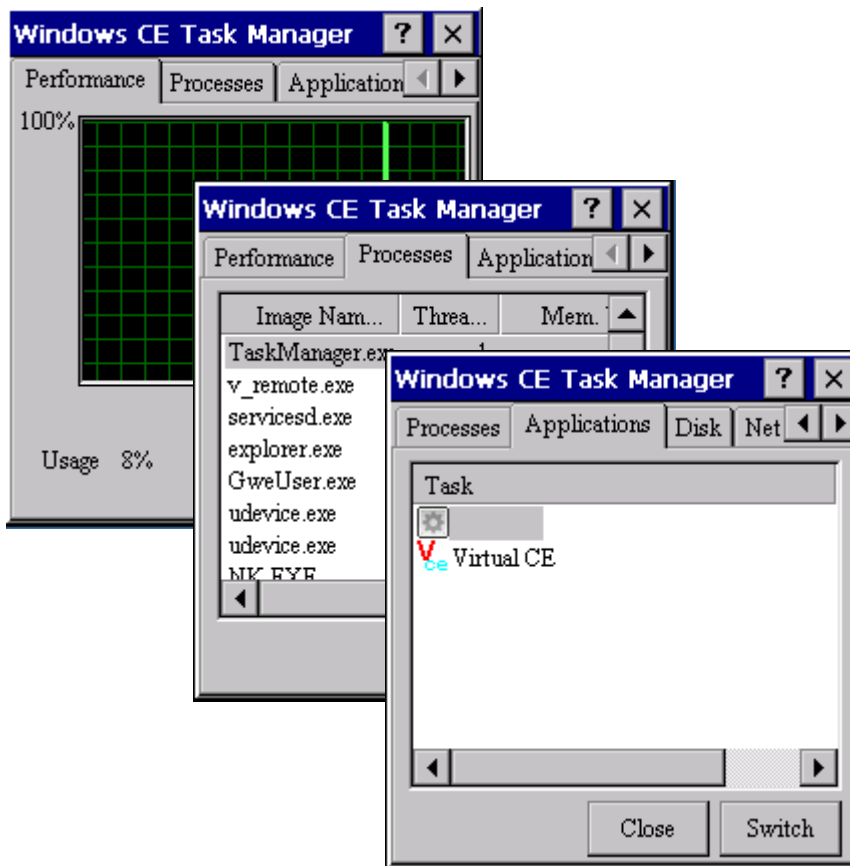

3.4. VCEP

ICPDAS VCEP is designed for managing your WinPAC anywhere. No matter where you are, ICPDAS VCEP provides a convenient environment on the Desktop PC and lets you control your WinPAC remotely.

ICPDAS VCEP is composed of two main components: The “Server” which runs on WinPAC and the ‘Client’ which runs on a Desktop PC.

Once a connection is established between the client and server (initiated by the client), the client will periodically send requests for screen updates and send mouse/key click information to the server to simulate.

Each video frame is inter-compressed against the previous frame and then intra-compressed with a modified LZW scheme to minimize the amount of data transmitted from server to client.

For more detailed information on VCEP application, please refer to

http://ftp.icpdas.com.tw/pub/cd/winpac/napdos/wp-8x4x_ce50/pc_tools/vcep_5.0.0.0/

3.5. Remote_Display

The "Remote Display" allows WinPAC to be controlled and monitored from a remote location. This tool is composed of two parts, a client and a server. The server is a program named cerdisp.exe running on WinPAC. The client is a PC-based program named cerhost.exe running on the PC.

3.6. SendToCOM

The SendToCOM uses the serial port to communicate with expansion module. To use the SendToCOM, you can send data to expansion module through the serial port, and receive data from other device through the serial port.

For more information about these commands for communicating with expansion module, please refer to:

http://www.icpdas.com/root/product/solutions/remote_io/rs-485/i-8k_i-87k/i-8k_i-87k_selection.html#b

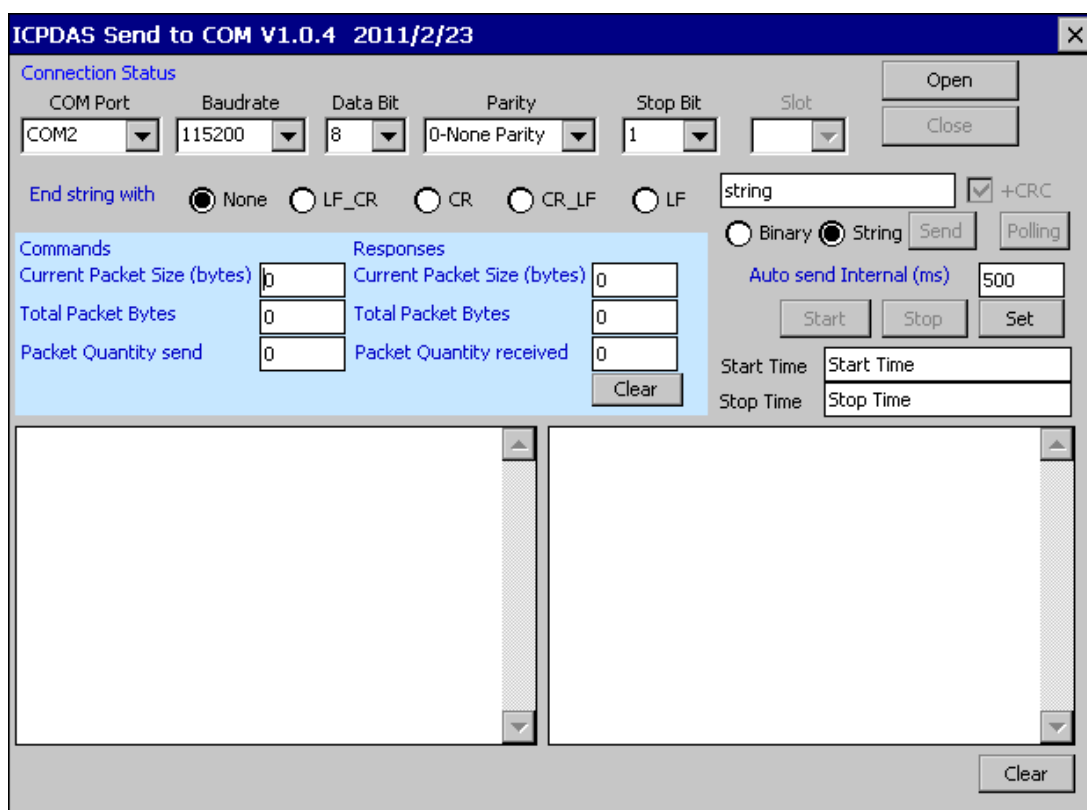

3.7. RegEdit

The RegEdit provides a hierarchical representation of the registry on a target computer, similar in appearance to the Windows Registry Editor. The standard registry roots are represented; you can add keys beneath a root to point to existing registry keys, or you can add your own keys. Values can be changed for existing keys, or added for new keys, and default keys can be specified. For more information, see Registry Settings Management in Deployment.

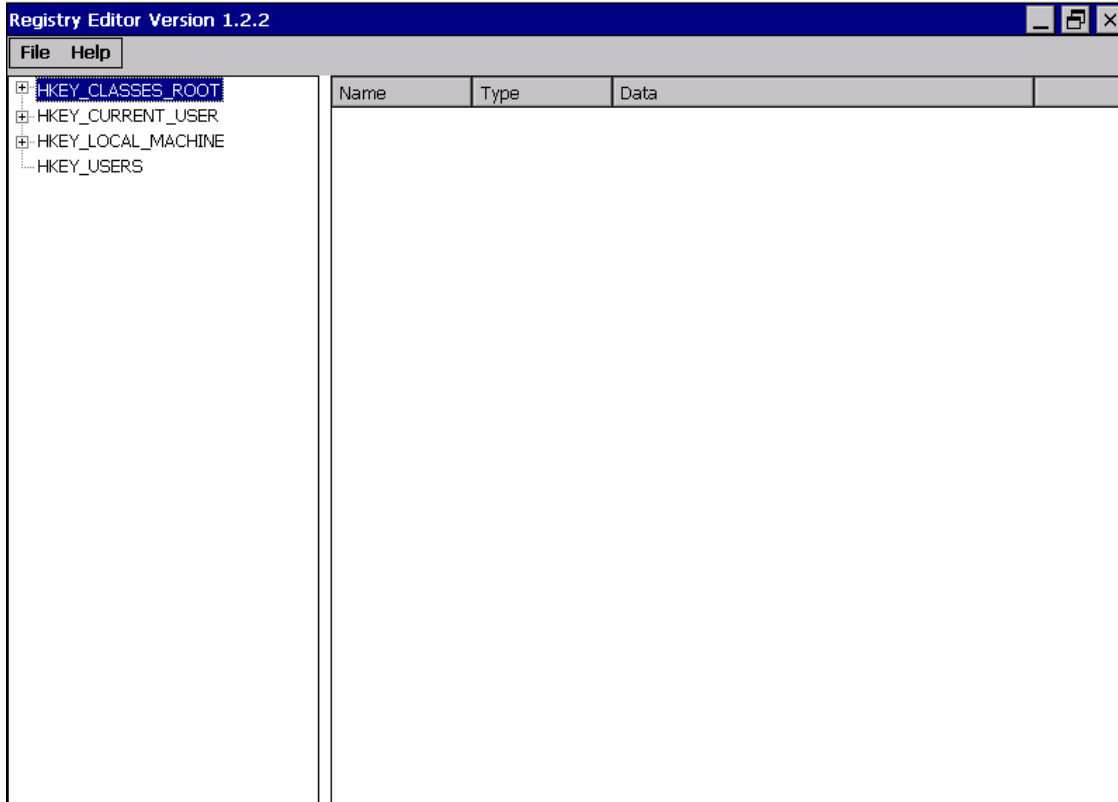

3.8. ISQLW35

The "ISQLW35" is a Windows Embedded Compact 7 functionality that implements SQL Server Compact 3.5 Query.

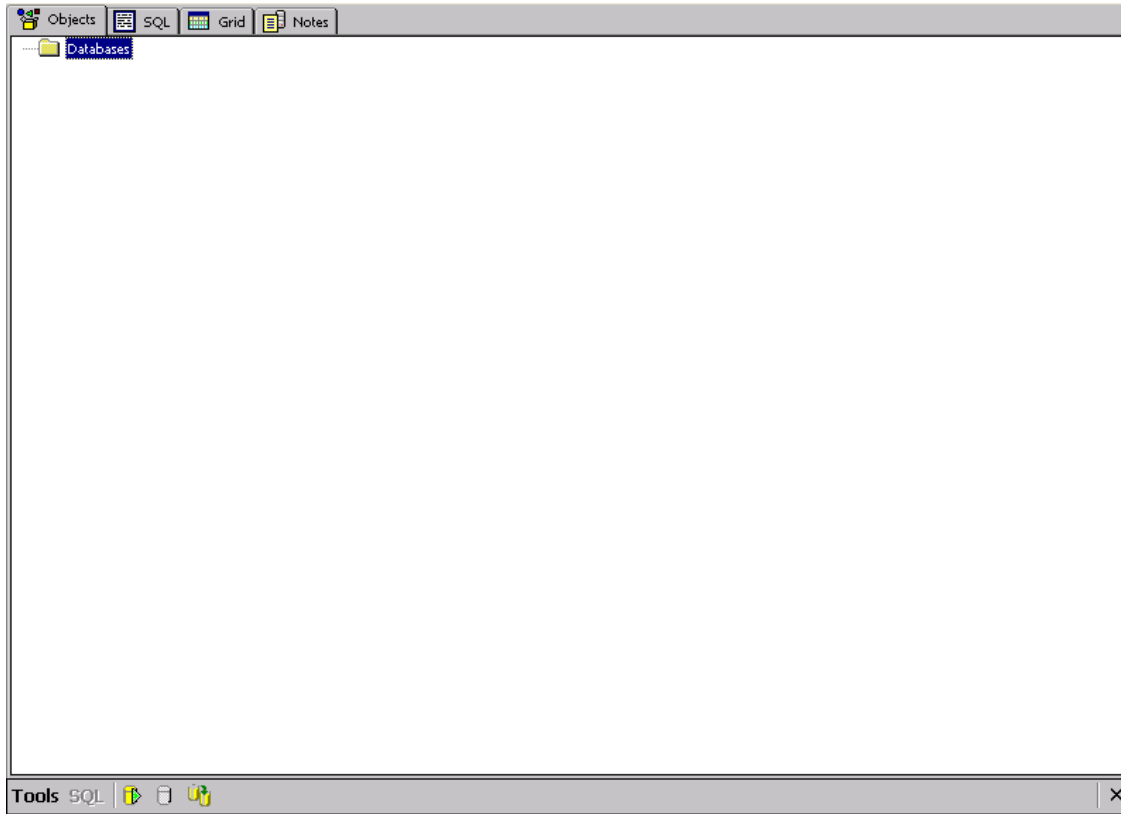

3.9. INotepad

The INotepad is a common text-only editor. The resulting files have no format tags or styles.

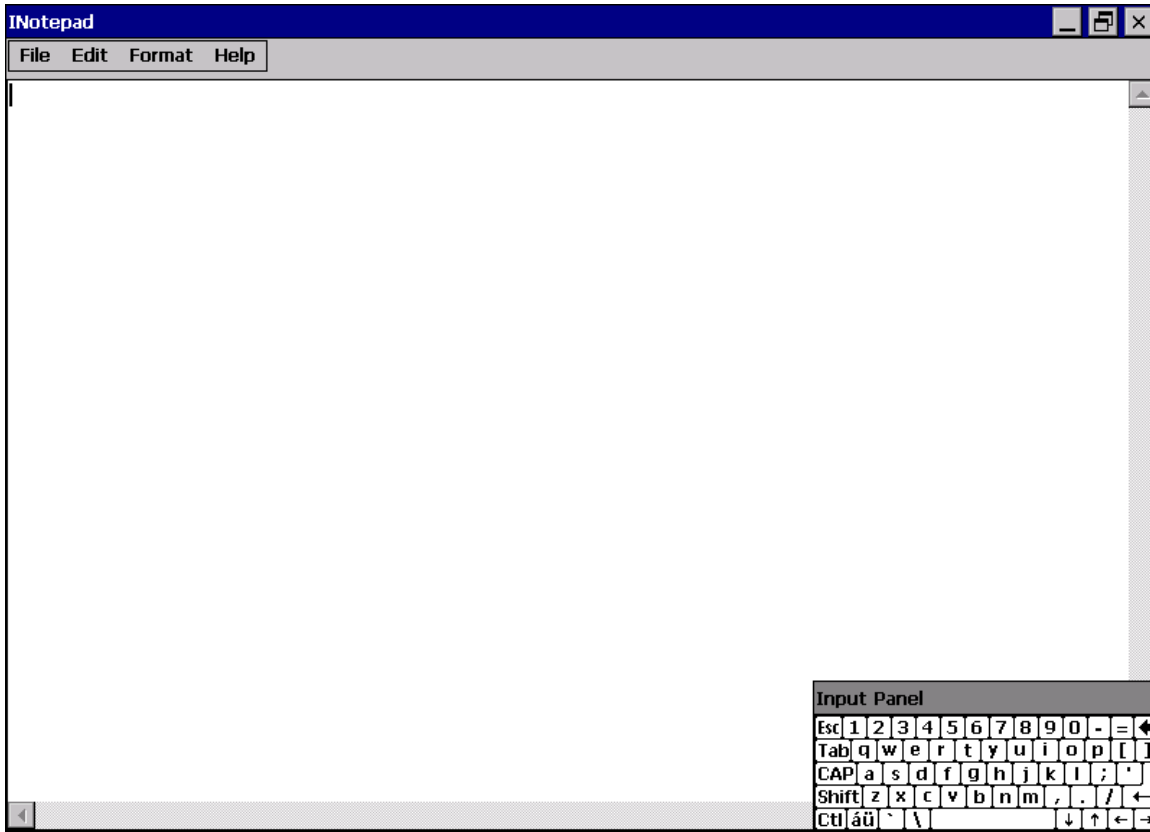

4. Your First WinPAC Program

This chapter provides a guided tour that describes the steps needed to set-up a development environment, download, install, configure for user programming with the WP-2241M-CE7.

Before writing your first program, ensure that you have the necessary development tool and the corresponding WinPAC SDKs are installed on your system.

Development Tools

WP-2241M-CE7 are Windows CE-based units. Windows CE is a mature embedded operating system which supports rapid development.

The table below lists the supported development tools and development languages to develop WP-2241M-CE7 applications.

Development Tools		Languages	Visual Basic.Net	Visual C#	Visual C++
Visual Studio 2005 or earlier	Any versions except Professional		-	-	-
	Professional		-	-	-
Visual Studio 2008	Any versions except Professional		-	-	-
	Professional		√	√	√
Visual Studio 2012 or later	Any versions except Professional		-	-	-
	Professional		-	-	-

4.1. Preparing the Development Tools

WP-2241M-CE7 is a Windows CE-based unit. Windows CE is a mature embedded operating system which supports rapid development. The standard development tool is list as follows which is highly integrated, with comprehensive support for developing applications of Windows CE-based WP-2241M-CE7.

➤ Visual Studio 2008



WP-2241M-CE7 has .NET Compact Framework 3.5 installed. Visual Studio 2008 takes full advantage of the .NET Compact Framework, which uses public Internet standards to enable integration with new and existing applications running on any platform. Supported languages include Visual C#, Visual C++ and Visual Basic .NET.

Installation Steps:

1. Visual Studio 2008 Professional

Purchase from MSDN subscription

Microsoft DreamSpark: <https://www.dreamspark.com/Product/Product.aspx?productid=1>

2. Visual Studio 2008 Service Pack 1

<http://www.microsoft.com/en-us/download/details.aspx?id=10986>

3. Visual Studio 2008 update for Windows Embedded Compact 7

<http://www.microsoft.com/en-us/download/confirmation.aspx?id=11935>

4. Windows Embedded Compact 7 ATL Update for Visual Studio 2008 SP1

<http://support.microsoft.com/kb/2468183/en-us>

4.2. Installing WP-2241M-CE7 SDK

The WinPAC SDK is a Software Development Kit (SDK) that contains C header files, C libraries and documents.

Step 1: Get the latest version of the installation package file and execute it

The installation program for the latest version of the WinPAC Platform SDKs can be obtained from:

http://ftp.icpdas.com/pub/cd/winpac_am335x/wp-2241/sdk/platformsdk/

File name: am335x_wince7_sdk_yyyymmdd.msi
yyymmdd: platform sdk released date

Step 2: Follow the prompts until the installation is complete

Step 3: Execute the “VisualStudioDeviceWindowsEmbeddedCompact7.msi”

The VisualStudioDeviceWindowsEmbeddedCompact7.msi can be obtained from:

http://ftp.icpdas.com/pub/cd/winpac_am335x/wp-2241/sdk/platformsdk/

Step 4: Execute any VS2008 C++ project include the AM335x_WINCE7_SDK(ARMv4I) platform and the click the “Tools”->”Options...”

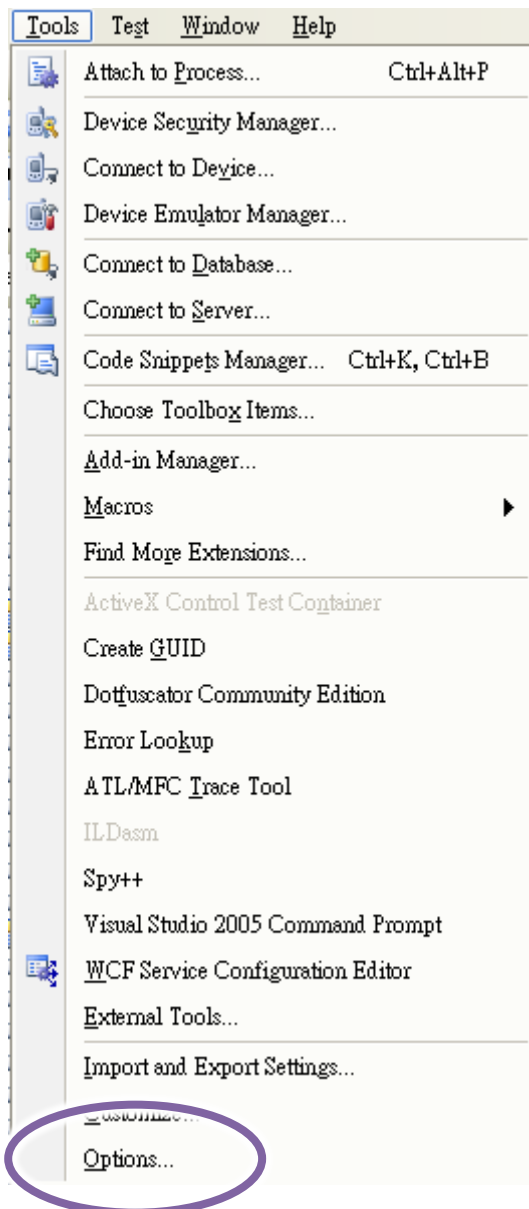

Step 5: Click the “Projects and Solutions”->”VC++ Directories” and then select the “AM335x_WINCE7_SDK (ARMv4I)” 、 “Include files” at “Platform:” and “Show directories for:” item

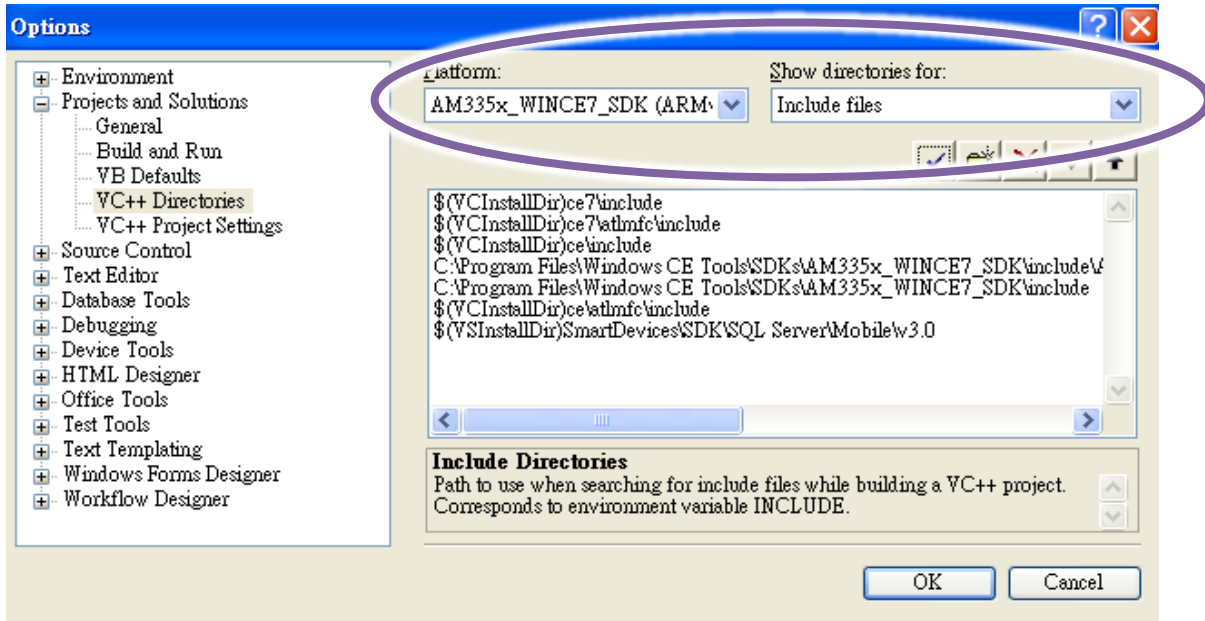

Step 6: Add the path “\$(VCInstallDir)ce7\include” and “\$(VCInstallDir)ce7\atlmfc\include” and then click the OK button.

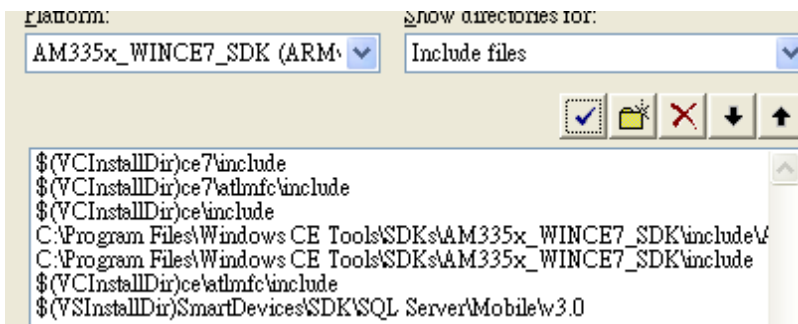

Tips & Warnings



The path “\$(VCInstallDir)ce7\include” and “\$(VCInstallDir)ce7\atlmfc\include” must be on the top of box.

4.3. First WinPAC Program in VB.NET

The best way to learn programming with WinPAC is to actually create a WinPAC program.

The example below demonstrates how to create a demo program running on WinPAC with VB.NET.

To create a demo program with VB.NET that includes the following main steps:

1. Create a new project
2. Specify the path of the PAC reference
3. Add the control to the form
4. Add the event handling for the control
5. Upload the application to WinPAC
6. Execute the application on WinPAC

All main steps will be described in the following subsection.

In this tutorial, we will assume that you have installed WP-2241M-CE7 SDK on PC and used the Visual Studio 2008 for application development.

4.3.1. Create a New Project

The Visual VB.net project template is a composite control that you use in this example creates a new project with this user control.

Step 1: Run the Visual Studio 2008

Visual Studio 2008



Step 2: On the File menu, point to New, and then click Project

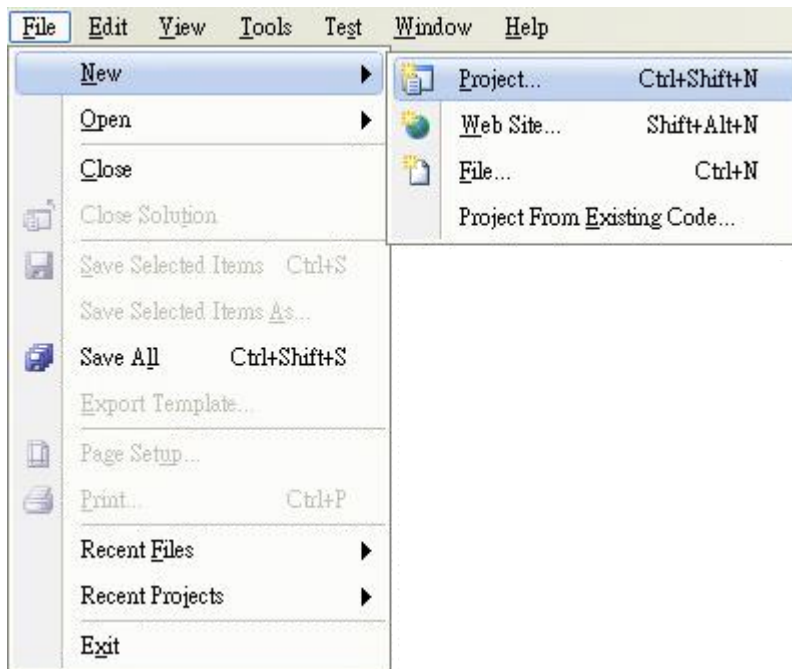

Step 3: In the Project types pane, expand Visual Basic, and then click Smart Device

Step 4: In the Templates pane, click Smart Device

Step 5: Type a name in the Name field, and then click OK

Here we will enter the name “SDKInformation” and a different location for the project if you wish

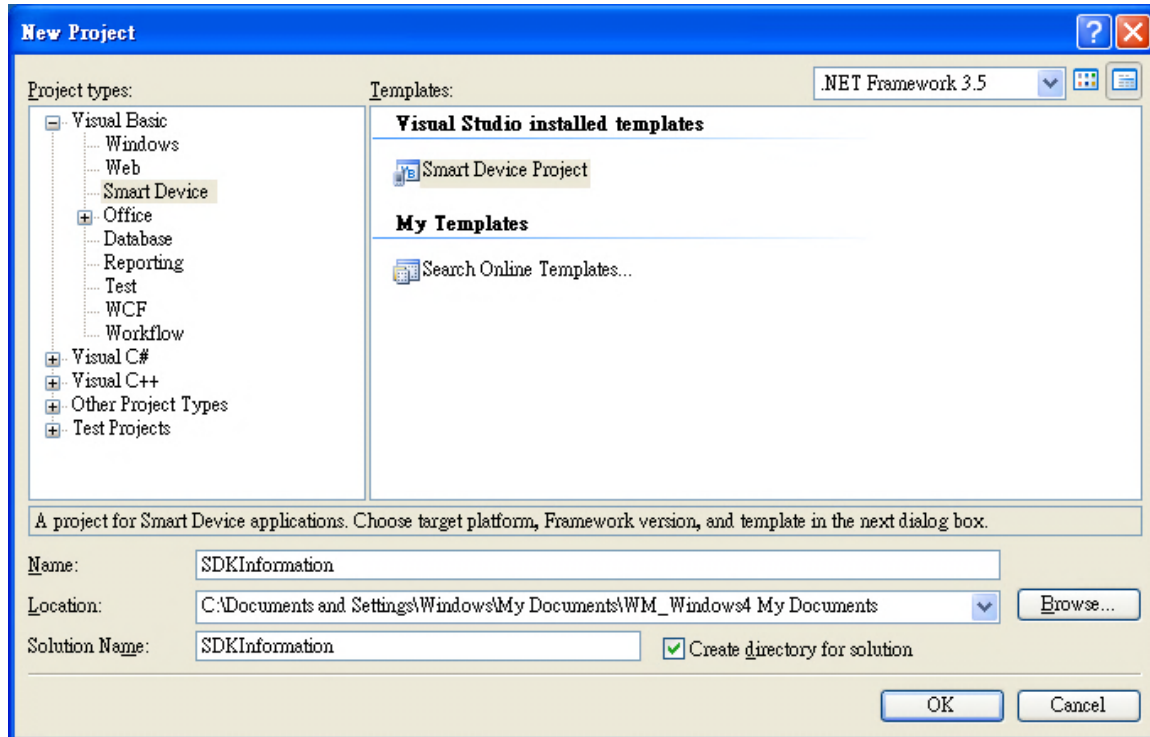

Tips & Warnings



The WCE7 only support .NET Compact Framework Version 3.5, if your application uses .NET Compact Framework Version 2.0 there is no guarantee that the program will function correctly.

Step 6: In the Target platform item, choose Windows CE

Step 7: in the .NET Compact Formwork version item, choose .NET Compact Framework Version 3.5

Step 8: in the Templates pane, choose Device Application, and then click Next

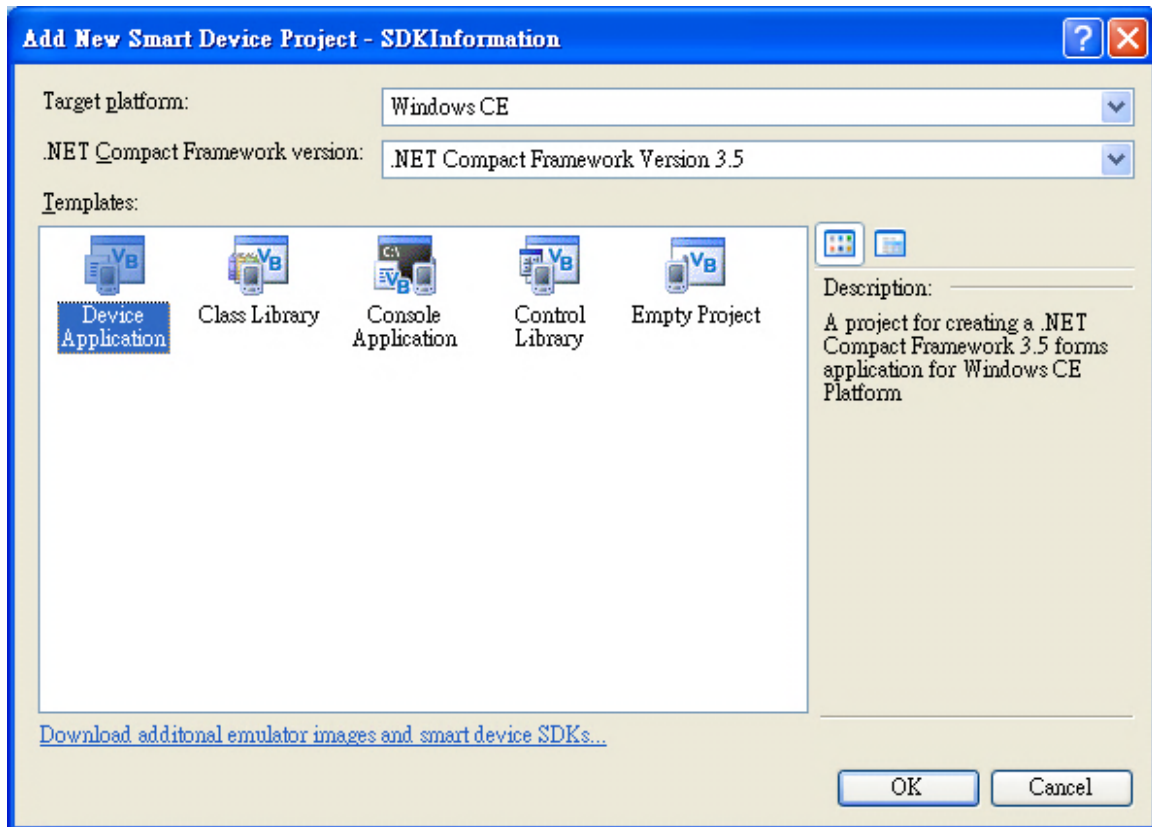

4.3.2. Specify the Path of PAC Reference

The PAC SDK provides a complete solution to integrate with WP-2241M-CE7 and it's compatible with Visual C#, Visual Basic .net and C++. In order to use a component in your application, you must first add a reference to it.

Step1: Get the PACNET.dll and copy it to the project folder

The PACNET.dll can be obtained from the link below that has been provided by downloading the latest version from ICP DAS web site.

http://ftp.icpdas.com/pub/cd/winpac_am335x/wp-2241/sdk/pacnet/



Step 2: In Solution Explorer, right-click the References node, and then click Add Reference...

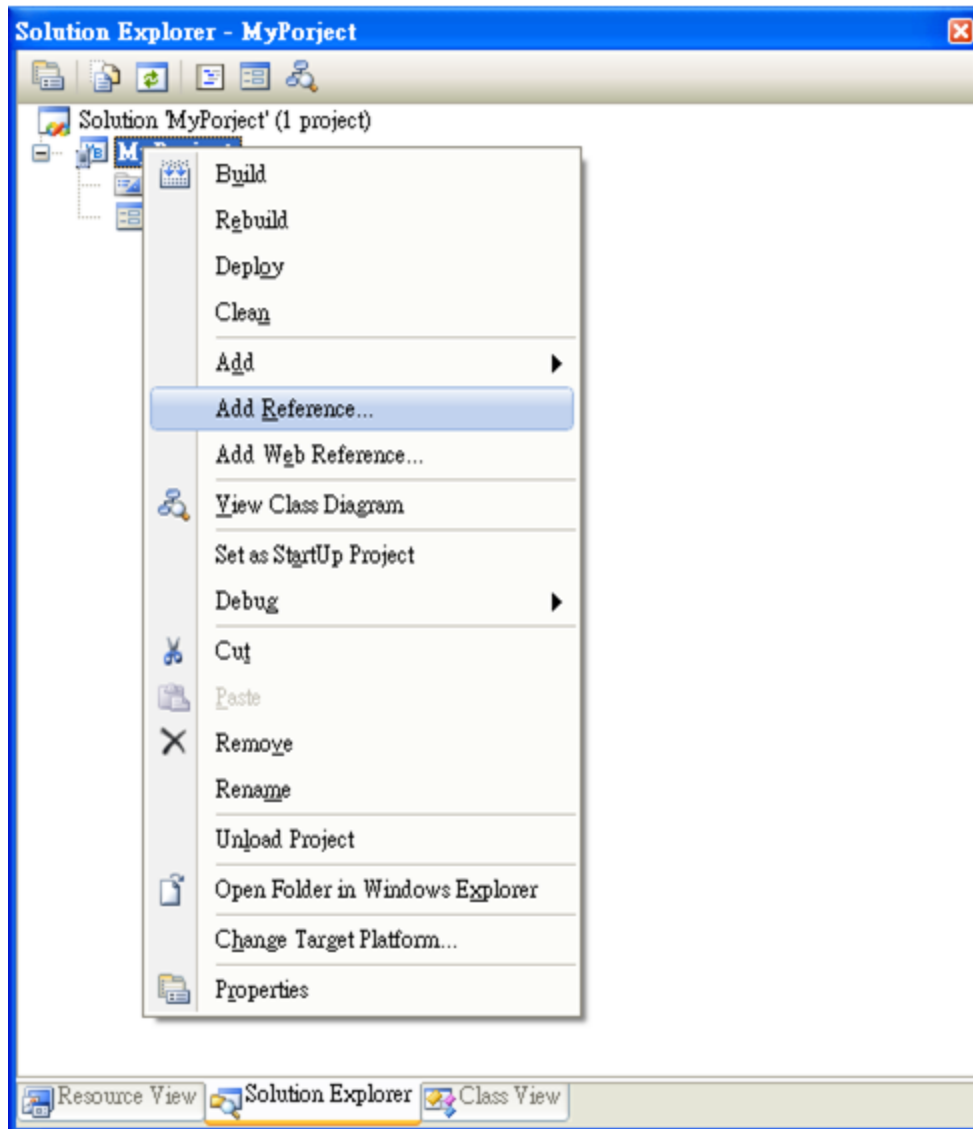

Step 3: Select Browse tab and add the PACNET.dll

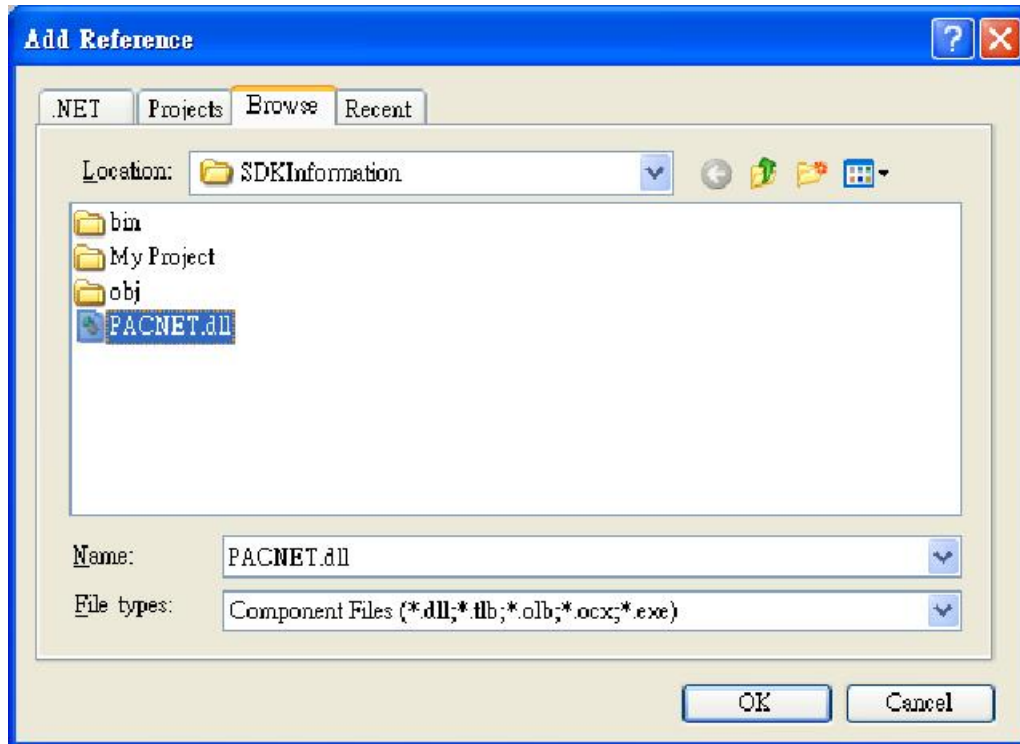

4.3.3. Add the Control to the Form

You can drag various controls from the Toolbox onto the form. These controls are not really "live"; they are just images that are convenient to move around on the form into a precise location.

After you add a control to your form, you can use the Properties window to set its properties, such as background color and default text. The values that you specify in the Properties window are the initial values that will be assigned to that property when the control is created at run time.

Step 1: From the Toolbox, drag a Button control onto the form

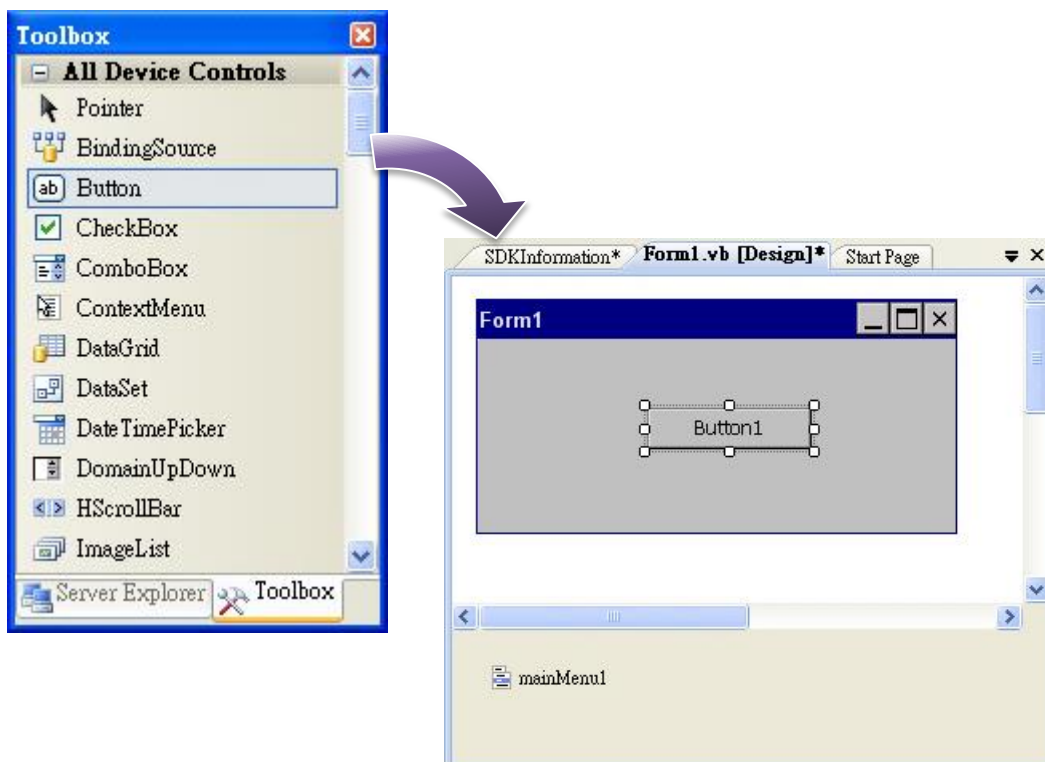

Step 2: Right-click the Button control, and then click Properties

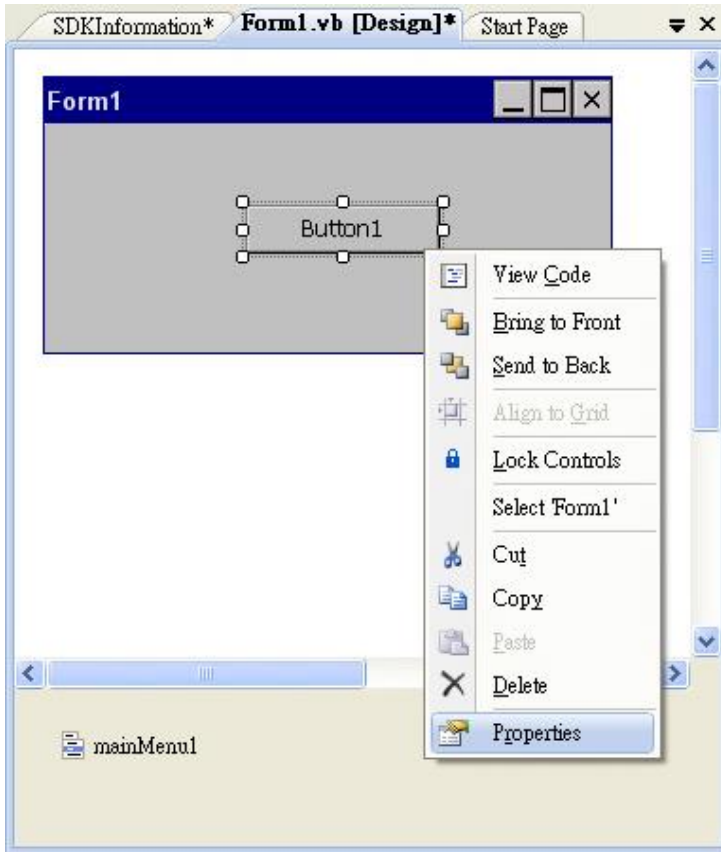

Step 3: In the Properties window, type Check the SDK version, and press ENTER to set the Text property

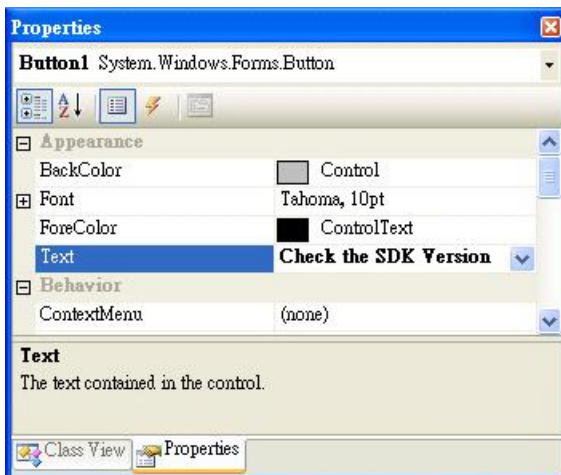

4.3.4. Add the Event Handling for the Control

You have finished the design stage of your application and are at the point when you can start adding some code to provide the program's functionality.

Step 1: Double-click the button on the form

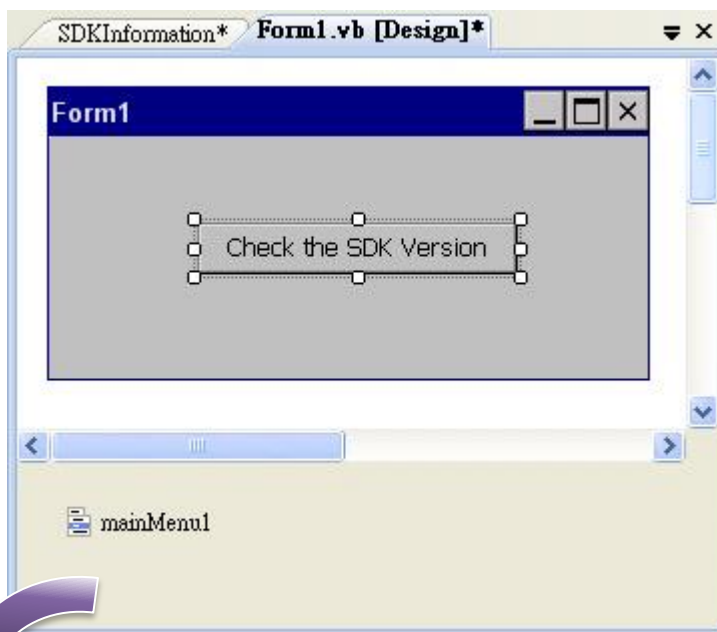

Step 2: Inserting the following code

```
Dim data(30) As Byte
PACNET.Sys.GetSDKVersion(data)
MessageBox.Show(PACNET.MISC.WideString(data))
```

```
Public Class Form1
    Private Sub Button1_Click(ByVal sender As System.Object, ByVal e As System.EventArgs) Handles Button1.Click
        Dim data(30) As Byte
        PACNET.System.GetSDKVersion(data)
        MessageBox.Show(PACNET.MISC.WideString(data))
    End Sub
End Class
```

Tips & Warnings



The "PACNET" of "using PACNET" is case-sensitive.

4.3.5. Upload the Application to WinPAC

WinPAC supports FTP server service. You can upload files to WinPAC or download files from a public FTP server.

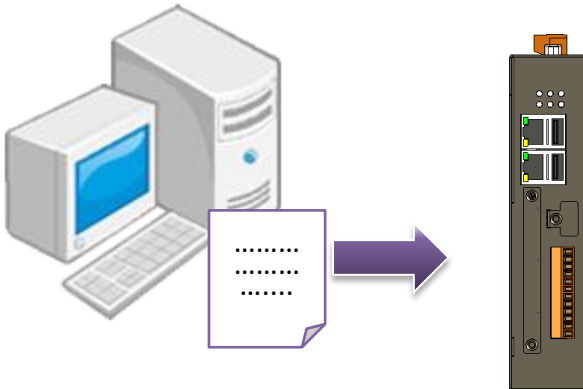

Step 1: On the Build menu, click Build SDKInformation

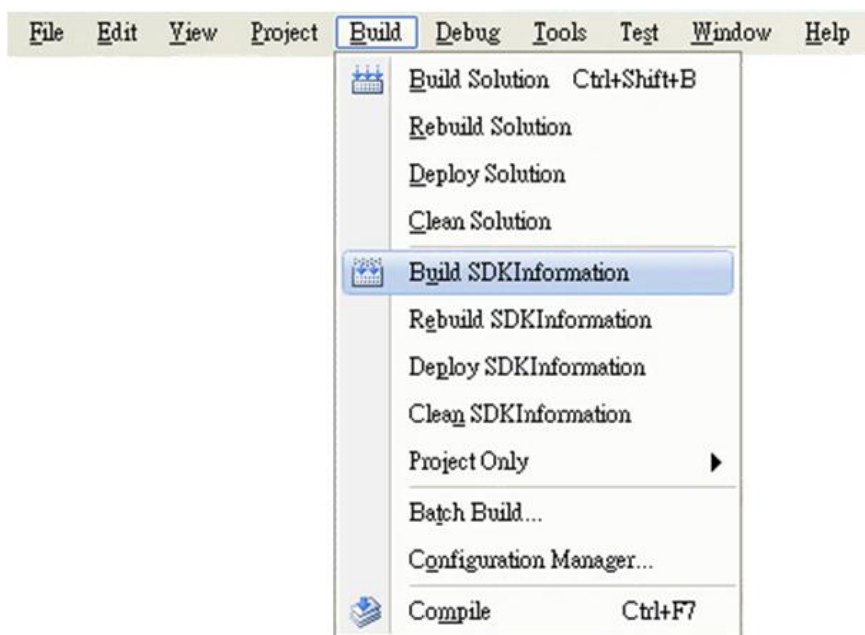

Step 2: Open the browser and type the IP address of WinPAC

Step 3: Upload the SDKInformation.exe application and the corresponding PACSDK.dll and PACNET.dll files to WinPAC

Tips & Warnings



For applications programming in C# and VB.net with .net compact framework, when executing these application on WinPAC, the corresponding PACSDK.dll and PACNET.dll must be in the same directory as the .exe file.

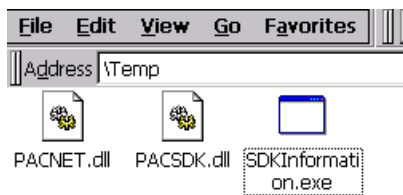

4.3.6. Execute the Application on WinPAC

After uploading the application to WinPAC, you can just double-click it on WinPAC to execute it.



4.4. First WinPAC Program in Visual C#

The best way to learn programming with WinPAC is to actually create a WinPAC program.

The example below demonstrates how to create a demo program running on WinPAC with C#.

To create a demo program with C# that includes the following main steps:

1. Create a new project
2. Specify the path of the PAC reference
3. Add the control to the form
4. Add the event handling for the control
5. Upload the application to WinPAC
6. Execute the application on WinPAC

All main steps will be described in the following subsection.

4.4.1. Create a New Project

The C# project template is a composite control that you use in this example creates a new project with this user control.

Step 1: Run the Visual Studio 2008

Visual Studio 2008



Step 2: On the File menu, point to New, and then click Project

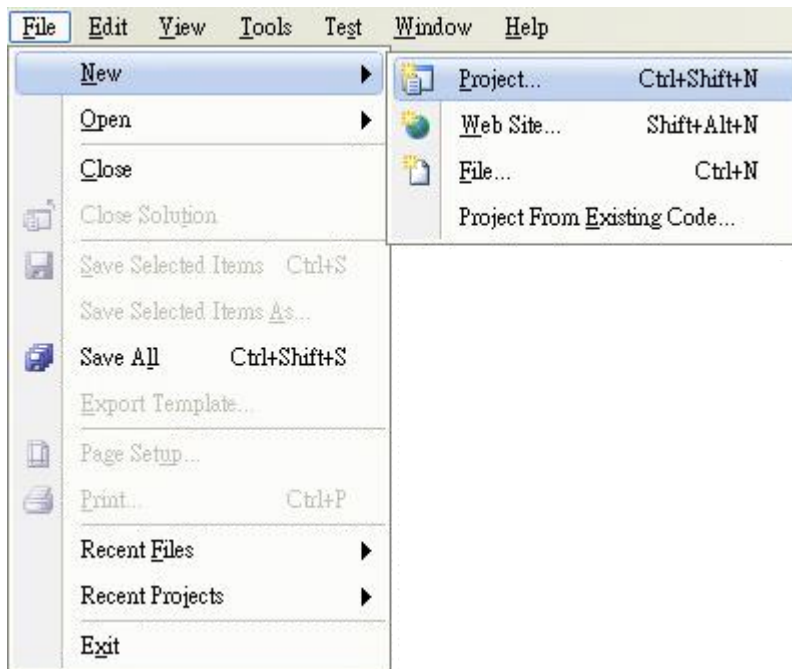

Step 3: In the Project types pane, expand Visual C#, and then click Smart Device

Step 4: In the Templates pane, click Smart Device

Step 5: Type a name in the Name field, and then click OK

Here we will enter the name “SDKInformation” and a different location for the project if you wish.

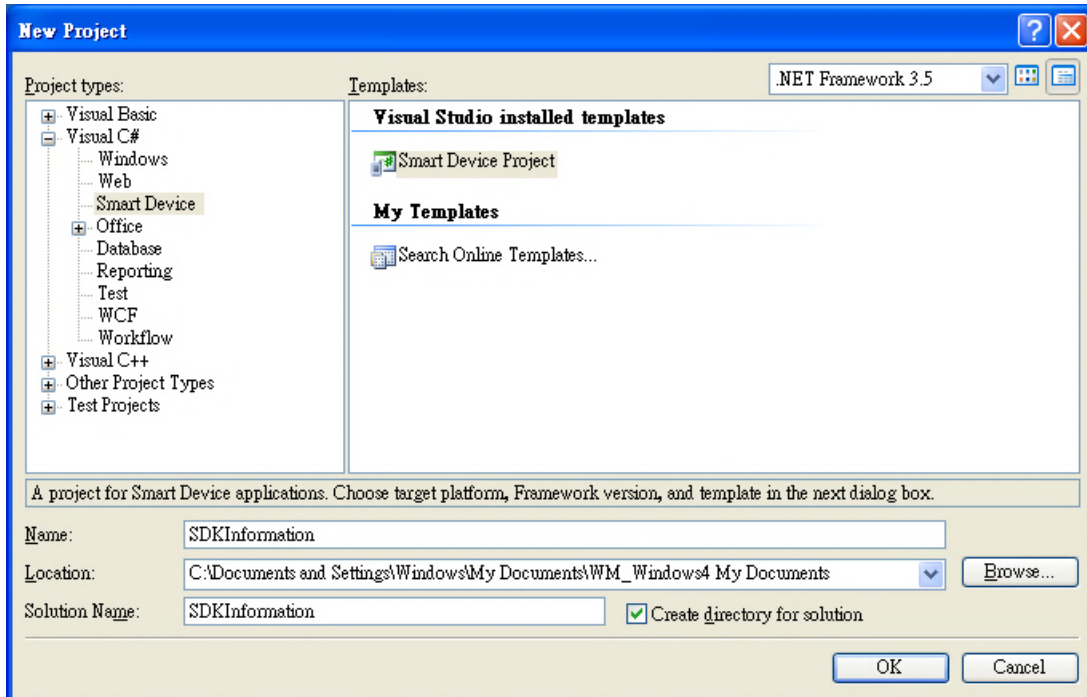

Step 6: In the Target platform item, choose Windows CE

Step 7: in the .NET Compact Formwork version item, choose .NET Compact Framework Version 3.5

Step 8: in the Templates pane, choose Device Application, and then click Next

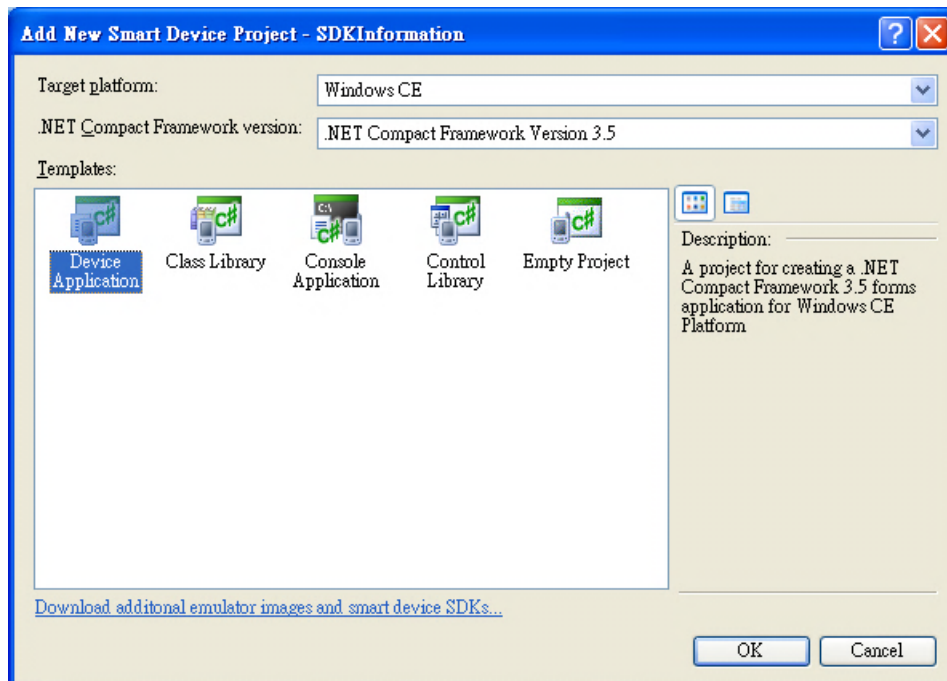

Tips & Warnings



The WCE7 only support .NET Compact Framework Version 3.5, if your application uses .NET Compact Framework Version 2.0 there is no guarantee that the program will function correctly.

4.4.2. Specify the Path of PAC Reference

The PAC SDK provides a complete solution to integrate with WP-2241M-CE7 and it's compatible with Visual C#, Visual Basic .net and C++. In order to use a component in your application, you must first add a reference to it.

Step1: Get the PACNET.dll and copy it to the project folder

The PACNET.dll can be obtained from the link below that has been provided by downloading the latest version from ICP DAS web site.

http://ftp.icpdas.com/pub/cd/winpac_am335x/wp-2241/sdk/pacnet/



Step 2: In Solution Explorer, right-click the References node, and then click Add Reference...

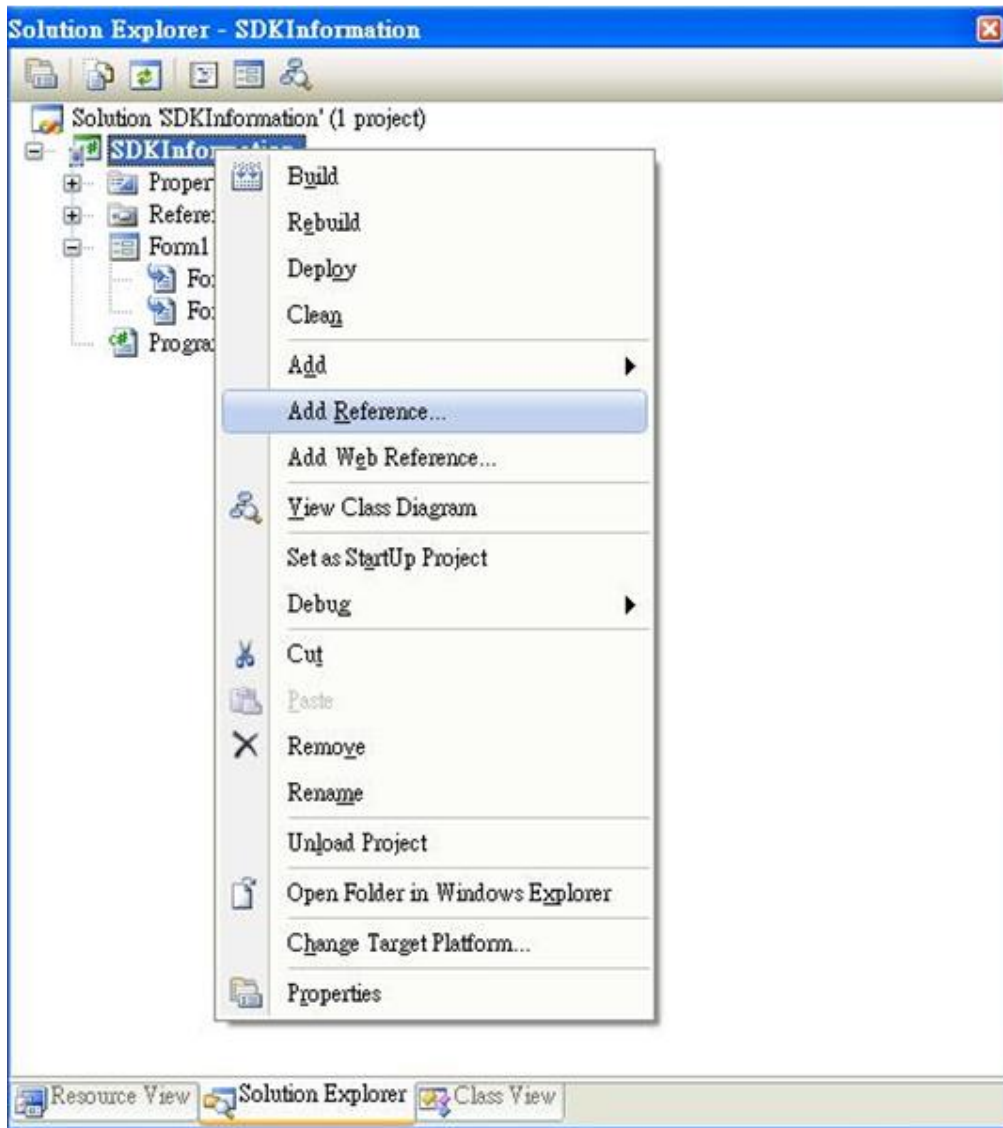

Step 3: Select Browse tab and add the PACNET.dll

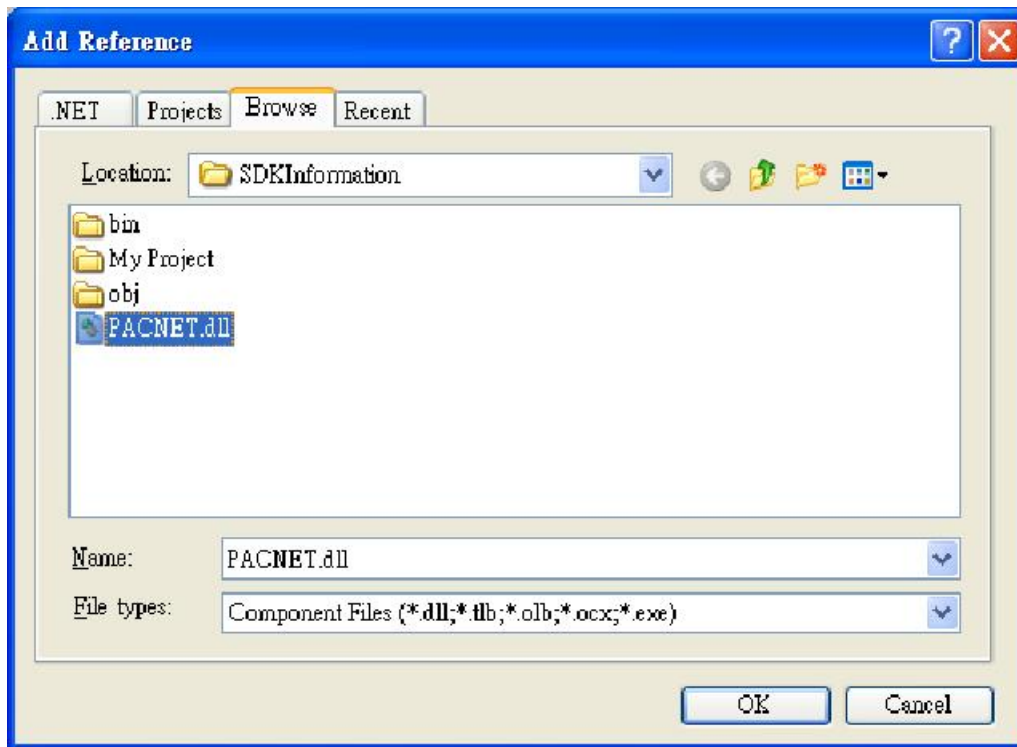

4.4.3. Add the Control to the Form

You can drag various controls from the Toolbox onto the form. These controls are not really "live"; they are just images that are convenient to move around on the form into a precise location.

After you add a control to your form, you can use the Properties window to set its properties, such as background color and default text. The values that you specify in the Properties window are the initial values that will be assigned to that property when the control is created at run time.

Step 1: From the Toolbox, drag a Button control onto the form

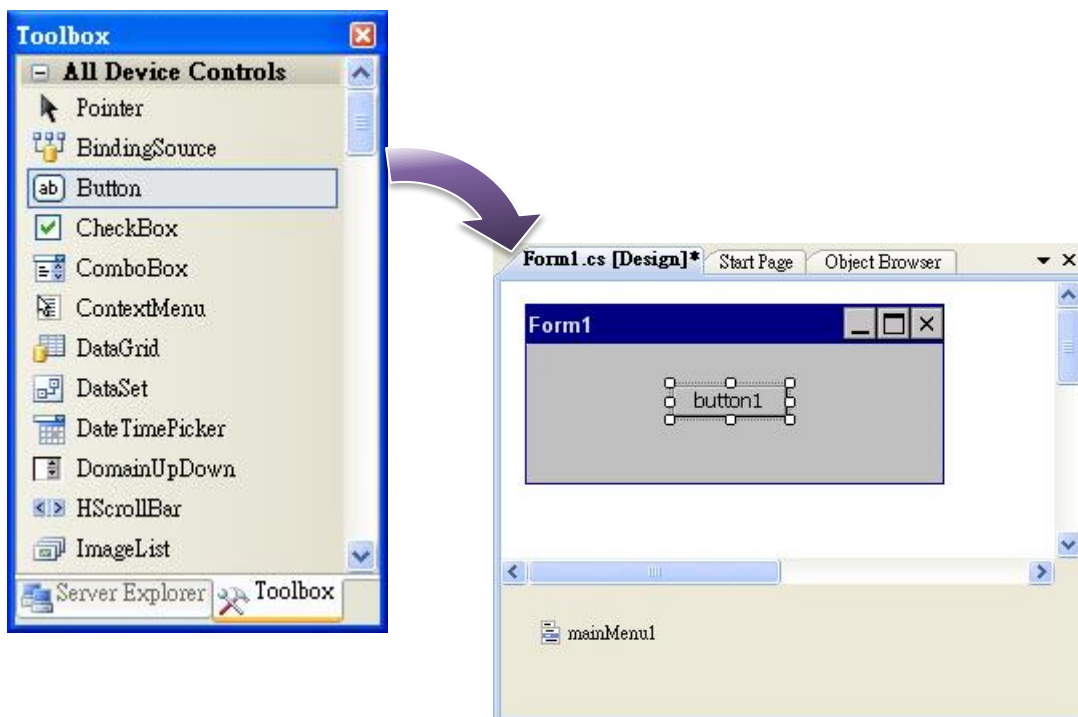

Step 2: Right-click the Button control, and then click Properties

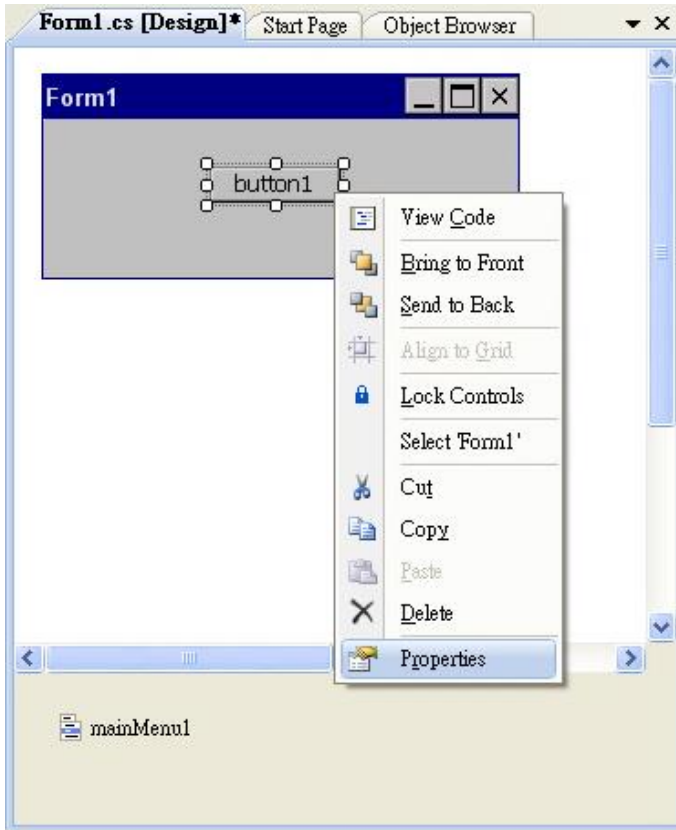

Step 3: In the Properties window, type Check the SDK version, and press ENTER to set the Text property

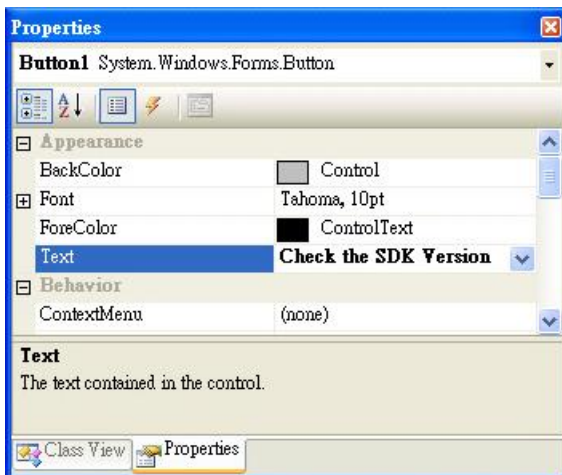

4.4.4. Add the Event Handling for the Control

You have finished the design stage of your application and are at the point when you can start adding some code to provide the program's functionality.

Step 1: Double-click the button on the form

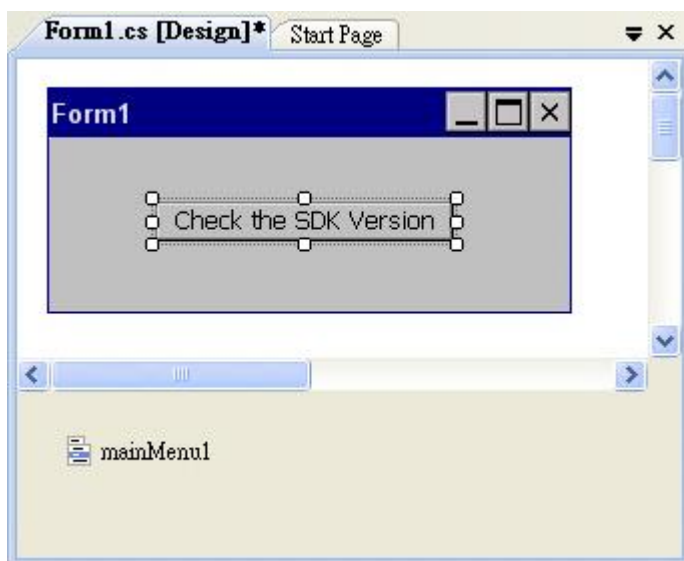

Step 2: Inserting the following code

```
byte []data = new byte[30];  
PACNET.Sys.GetSDKVersion(data);  
MessageBox.Show(PACNET.MISC.WideString(data));
```

```
namespace SDKInformation  
{  
    public partial class Form1 : Form  
    {  
        public Form1()  
        {  
            InitializeComponent();  
        }  
  
        private void button1_Click(object sender, EventArgs e)  
        {  
            byte []data = new byte[30];  
            PACNET.Sys.GetSDKVersion(data);  
            MessageBox.Show(PACNET.MISC.WideString(data));  
        }  
    }  
}
```

4.4.5. Upload the Application to WinPAC

WinPAC supports FTP server service. You can upload files to WinPAC or download files from a public FTP server.

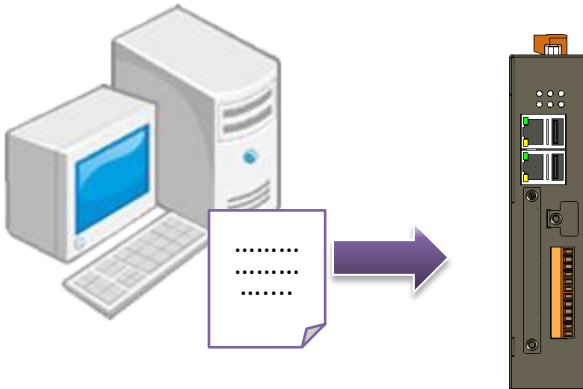

Step 1: On the Build menu, click Build SDKInformation

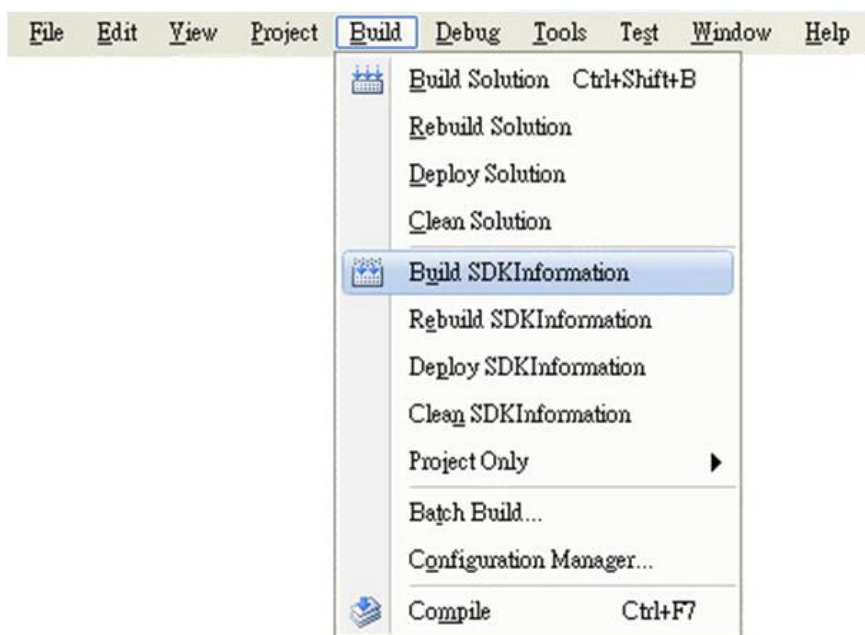

Step 2: Open the browser and type the IP address of WinPAC

Step 3: Upload the SDKInformation.exe application and the corresponding PACSDK.dll and PACNET.dll files to WinPAC

Tips & Warnings



For applications programming in C# and VB.net with .net compact framework, when executing these application on WinPAC, the corresponding PACSDK.dll and PACNET.dll must be in the same directory as the .exe file.

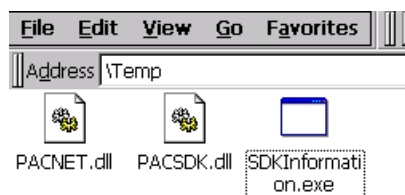

4.4.6. Execute the Application on WinPAC

After uploading the application to WinPAC, you can just double-click it on WinPAC to execute it.



4.5. First WinPAC Program in Visual C++

The best way to learn programming with WinPAC is to actually create a WinPAC program.

The example below demonstrates how to create a demo program running on WinPAC with Visual C++

To create a demo program with Visual C++ that includes the following main steps:

1. Create a new project
2. Configure the platform
3. Specify the path of the PAC reference
4. Add the control to the form
5. Add the event handling for the control
6. Upload the application to WinPAC
7. Execute the application on WinPAC

All main steps will be described in the following subsection.

Tips & Warnings



Before beginning a new project, the “Embedded Compact 7 ATL Update” must be installed. If this update is not installed, the error message “atlconv.h error C2039: lstrlenW” will be displayed after the program is compiled.

The update can be found by downloading the latest version from Microsoft.

<http://download.microsoft.com/download/9/D/D/9DDBD3EC-A43C-4BCE-A7A9-AEE9B1007BCE/VisualStudioDeviceWindowsEmbeddedCompact7.msi>

4.5.1. Create a New Project

The Visual C++ project template is a composite control that you use in this example creates a new project with this user control.

Step 1: Run the Visual Studio 2008

Visual Studio 2008



Step 2: On the File menu, point to New, and then click Project

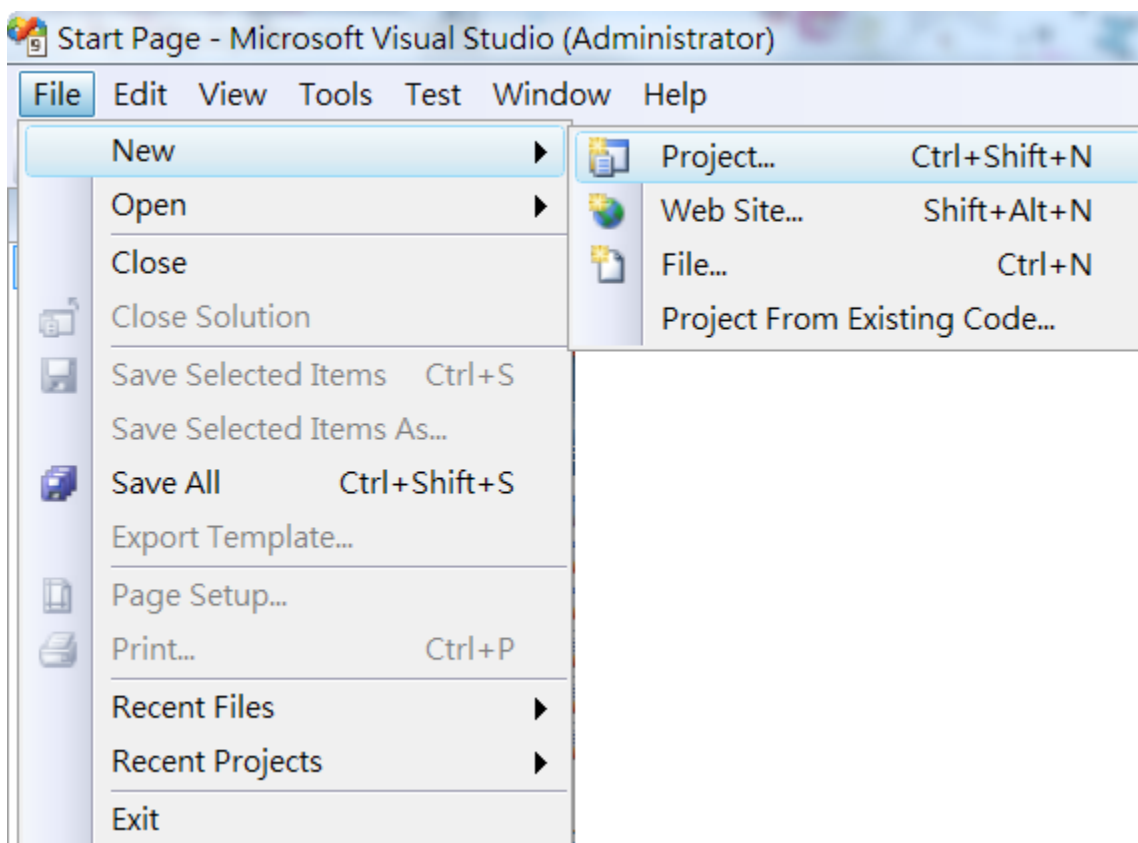

Step 3: In the Project types pane, expand Visual C++, and then click Smart Device

Step 4: In the Templates pane, click MFC Smart Device Application

Step 5: Type a name in the Name field, and then click OK

Here we will enter the name “SDKInformation” and a different location for the project if you wish

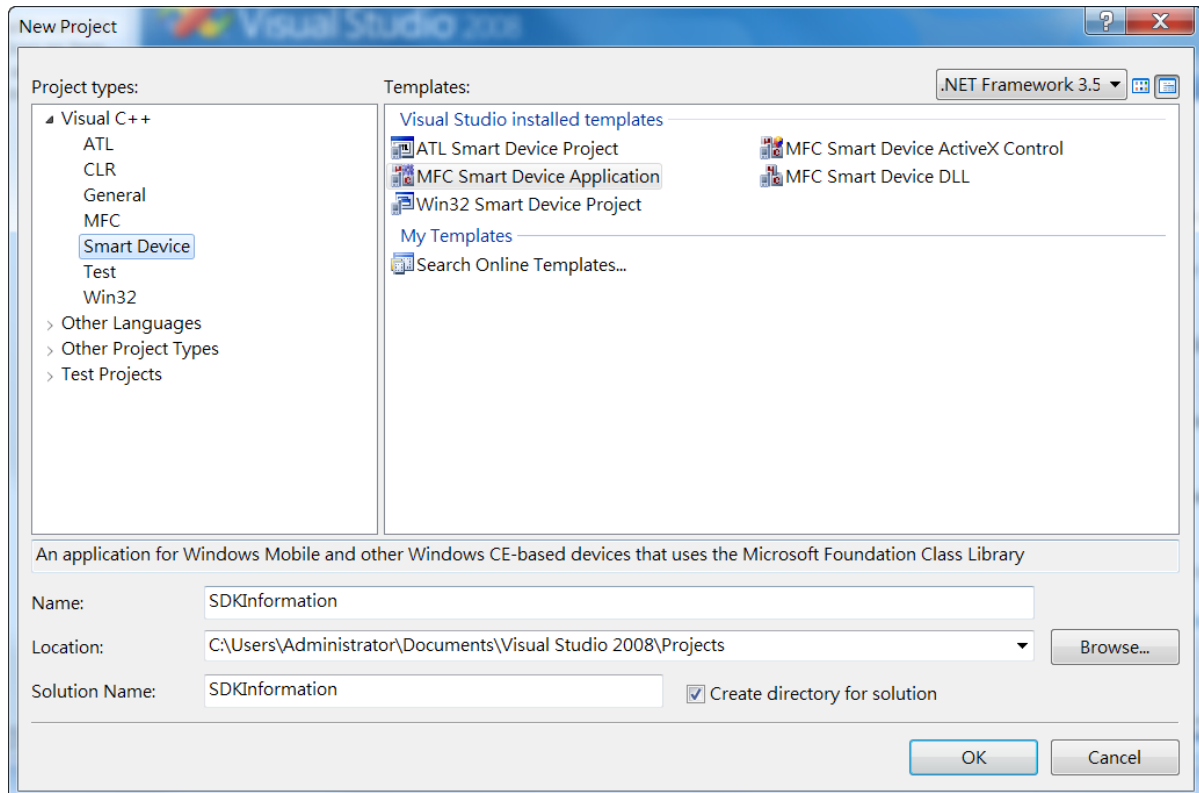

Step 6: On the first page of the wizard, click Next

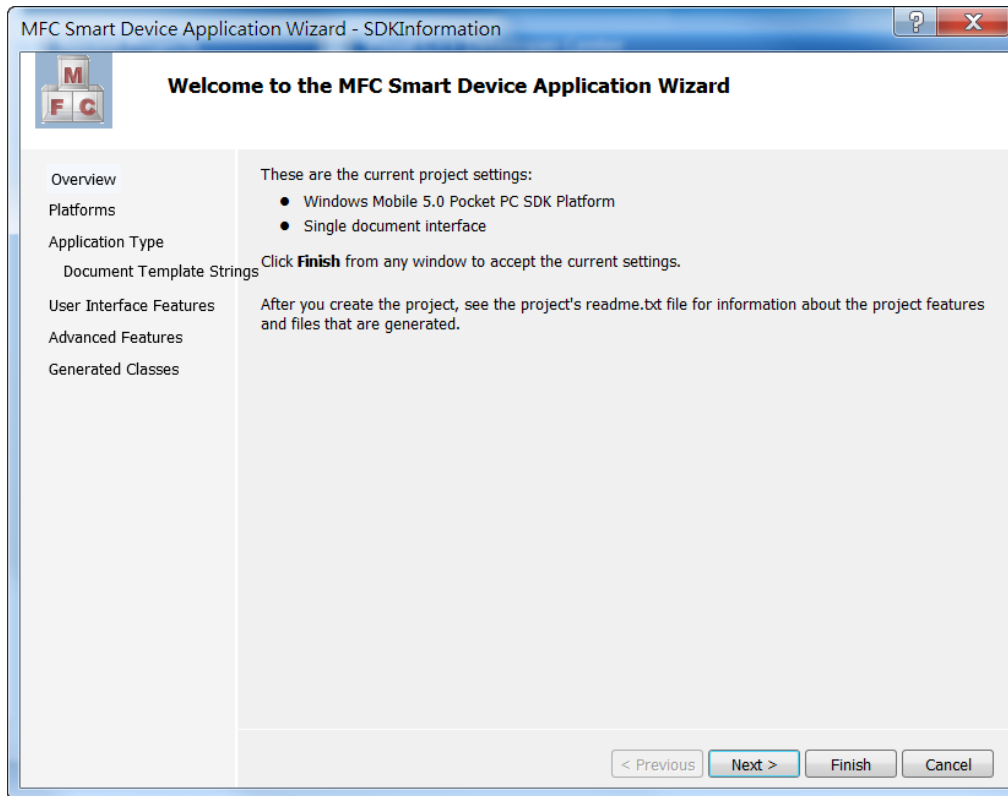

Step 7: On the next page of the wizard, select AM335x_WINCE7_SDK to be added to the project, and then click Next

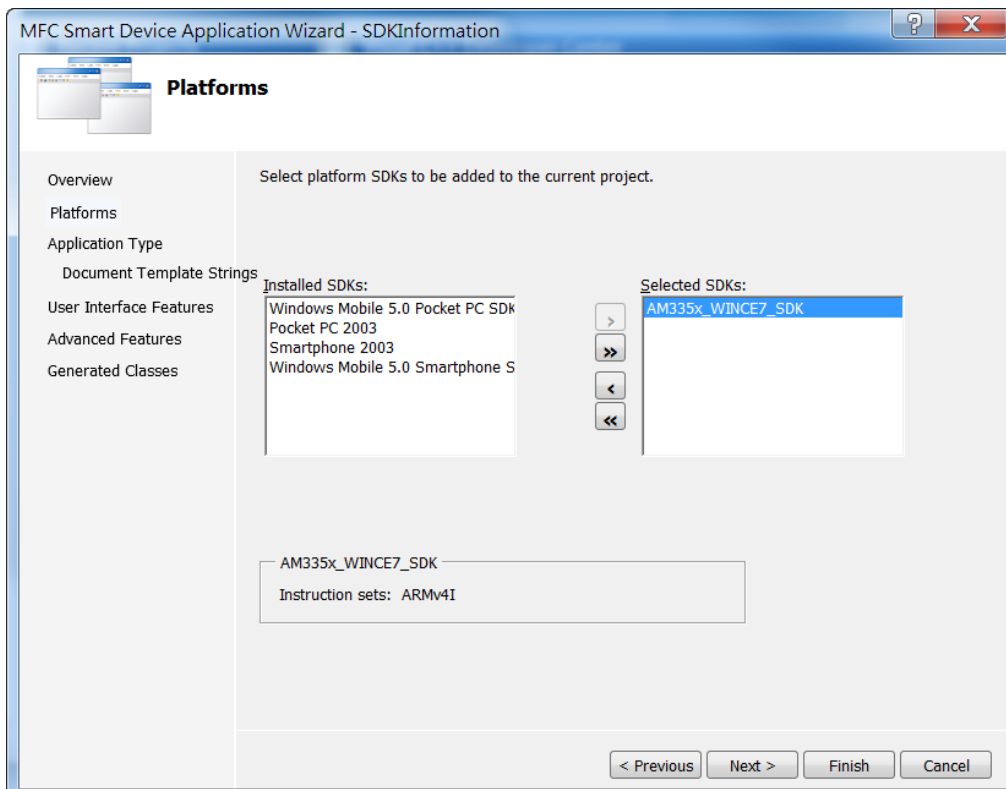

Step 8: On the next page of the wizard, select Dialog based, and then click next

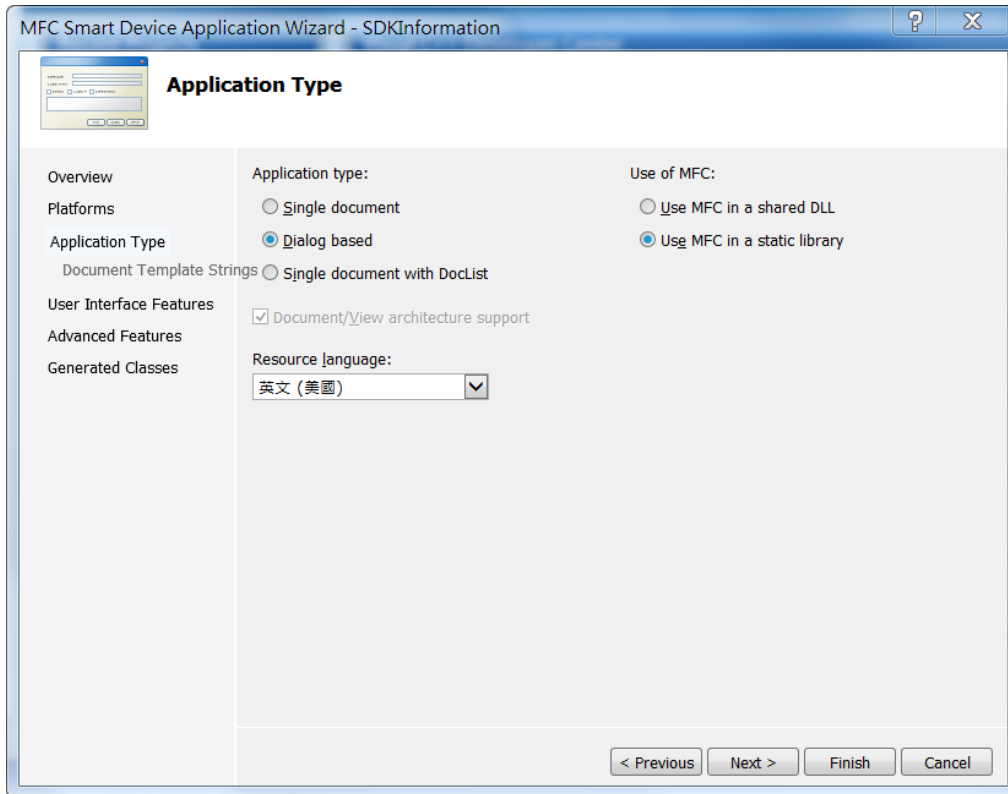

Step 9: On the next page of the wizard, click next

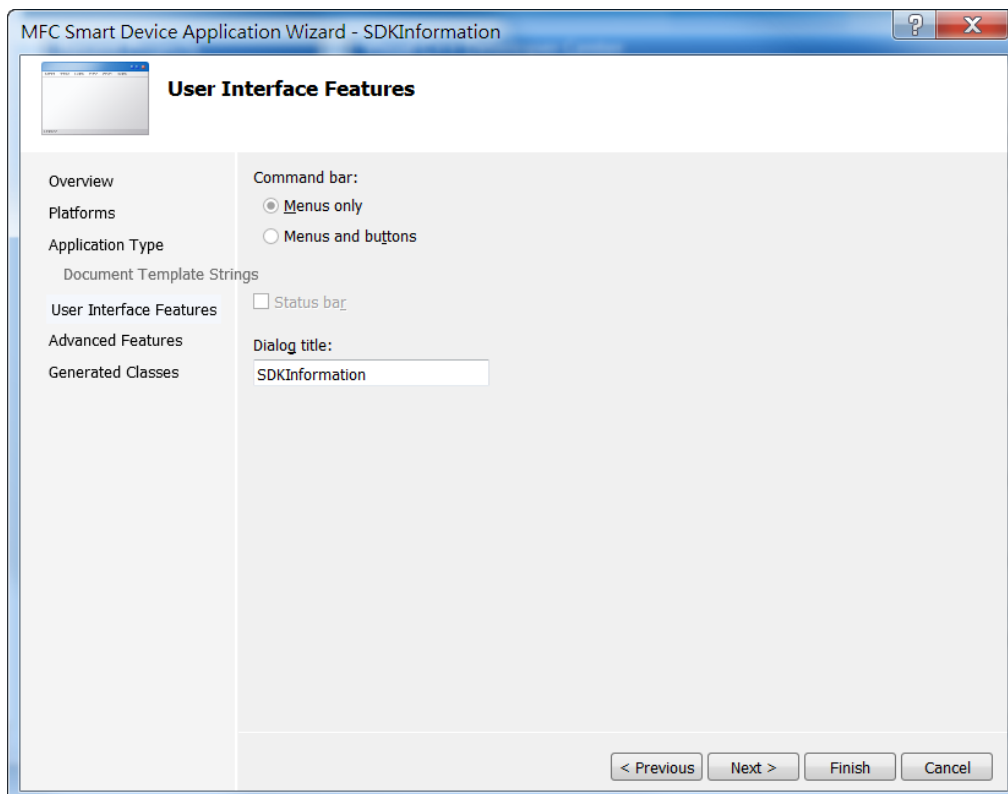

Step 10: On the next page of the wizard, click next

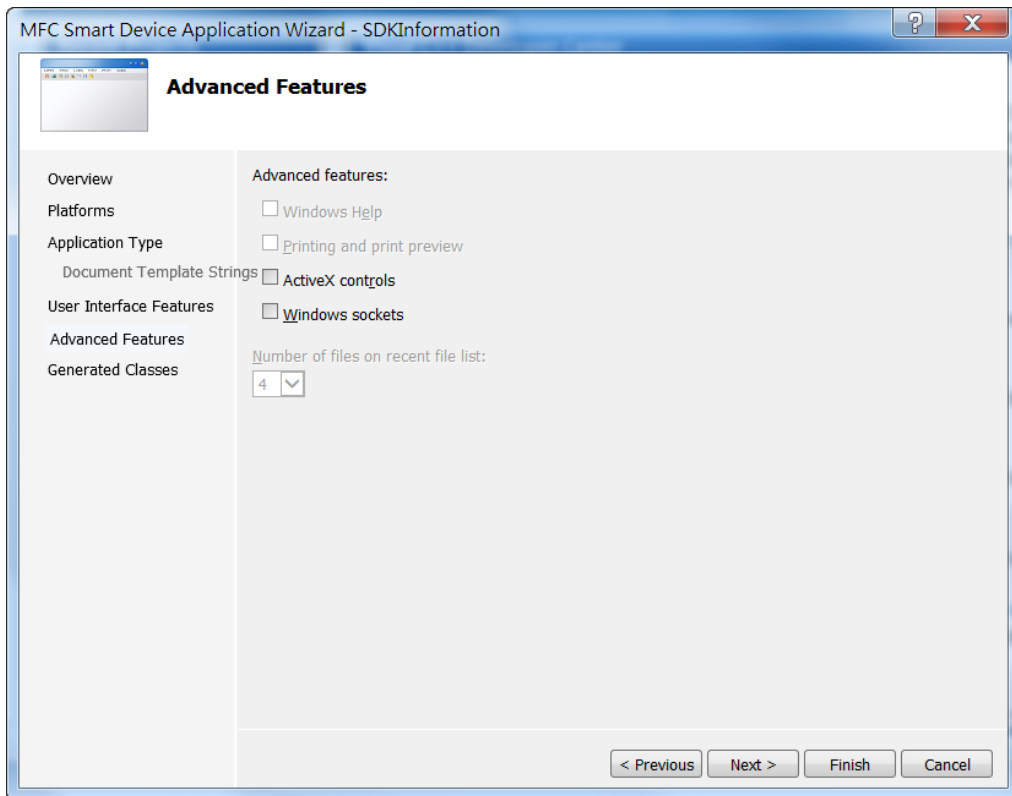

Step 11: On the next page of the wizard, click Finish

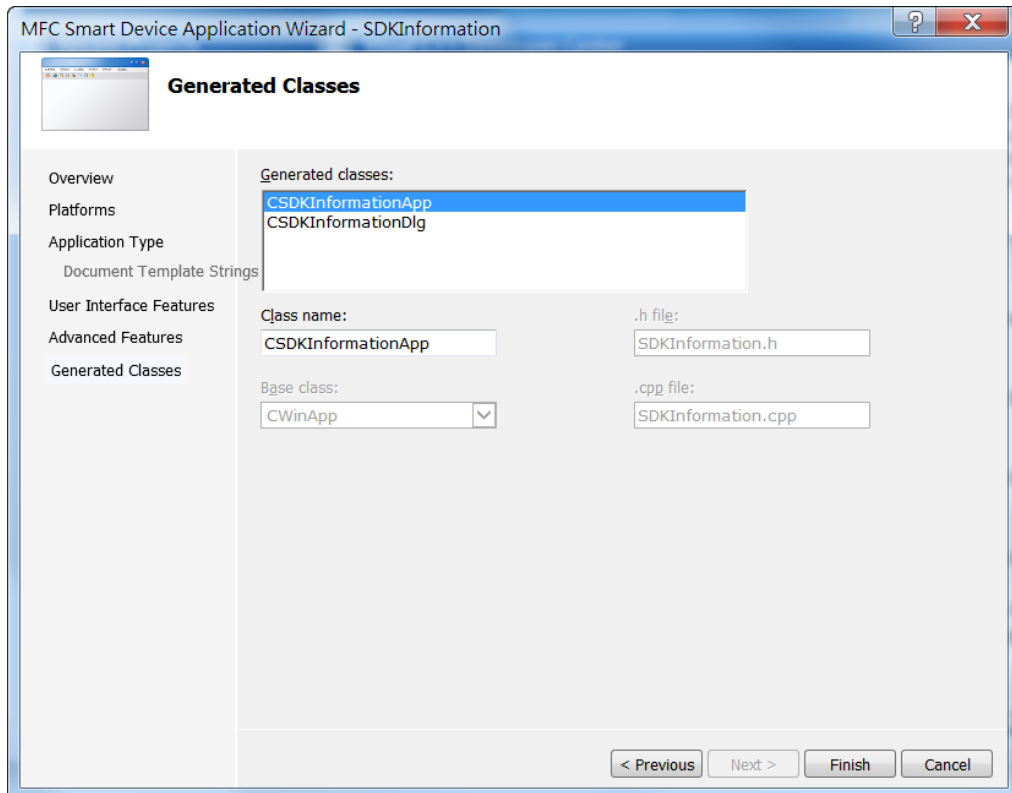

4.5.2. Configure the Platform

When developing applications by using Visual C++, you must configure the Platform to indicate what platform and device you intend to download the application to. Before you deploy your project, check the platform.

On the Debug configuration toolbar, select Release, and then on the Pocket PC 2003 (ARMV4) configuration toolbar, select AM335x_WINCE7_SDK(ARMv4I), as shown in the following illustration.

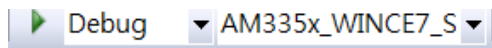

4.5.3. Specify the Path of PACSDK library and header files

The PAC SDK provides the PACSDK library and header files with WP-2241M-CE7.

It's compatible with C++. In order to use a component in your application, you must first add a reference to it.

Step 1: Right-click the project name, and then click Properties

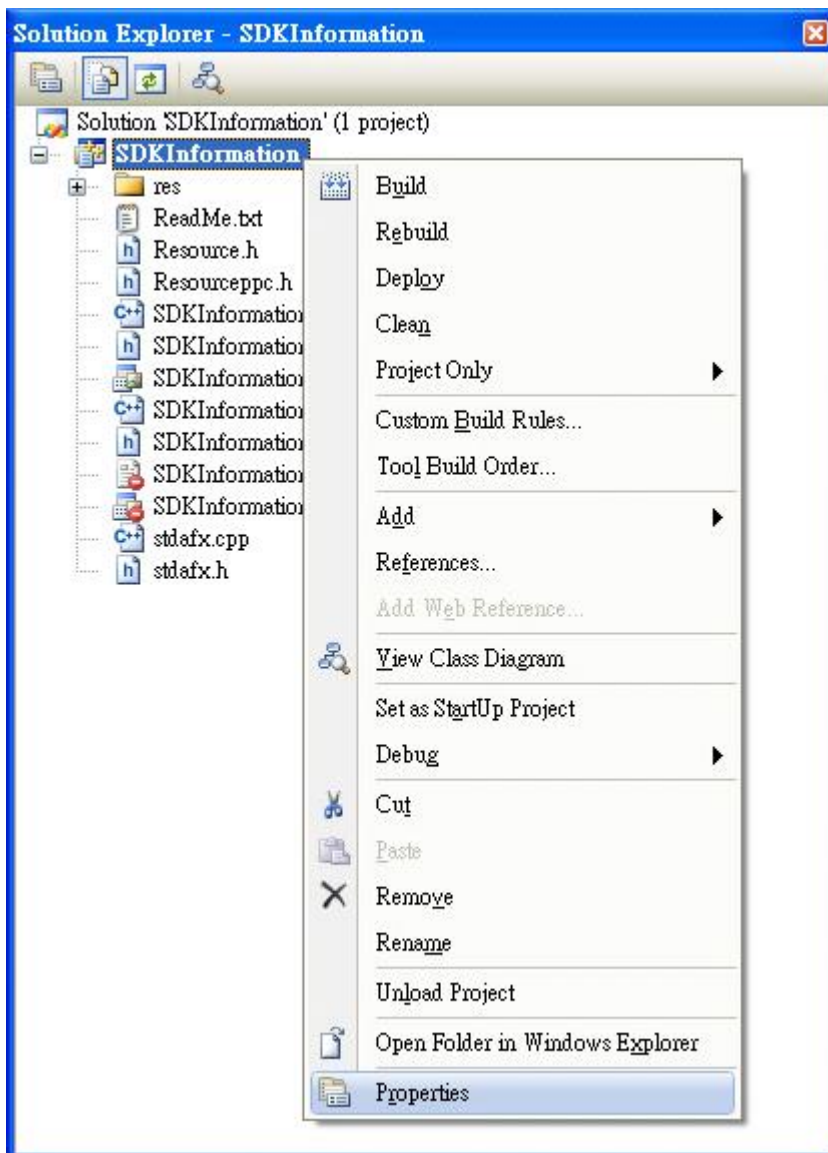

Step 2: In left pane, expand Configuration Properties, and then click Link

Step 3: In the right pane, choose the PACSDK_CE.lib in the Additional Dependencies item

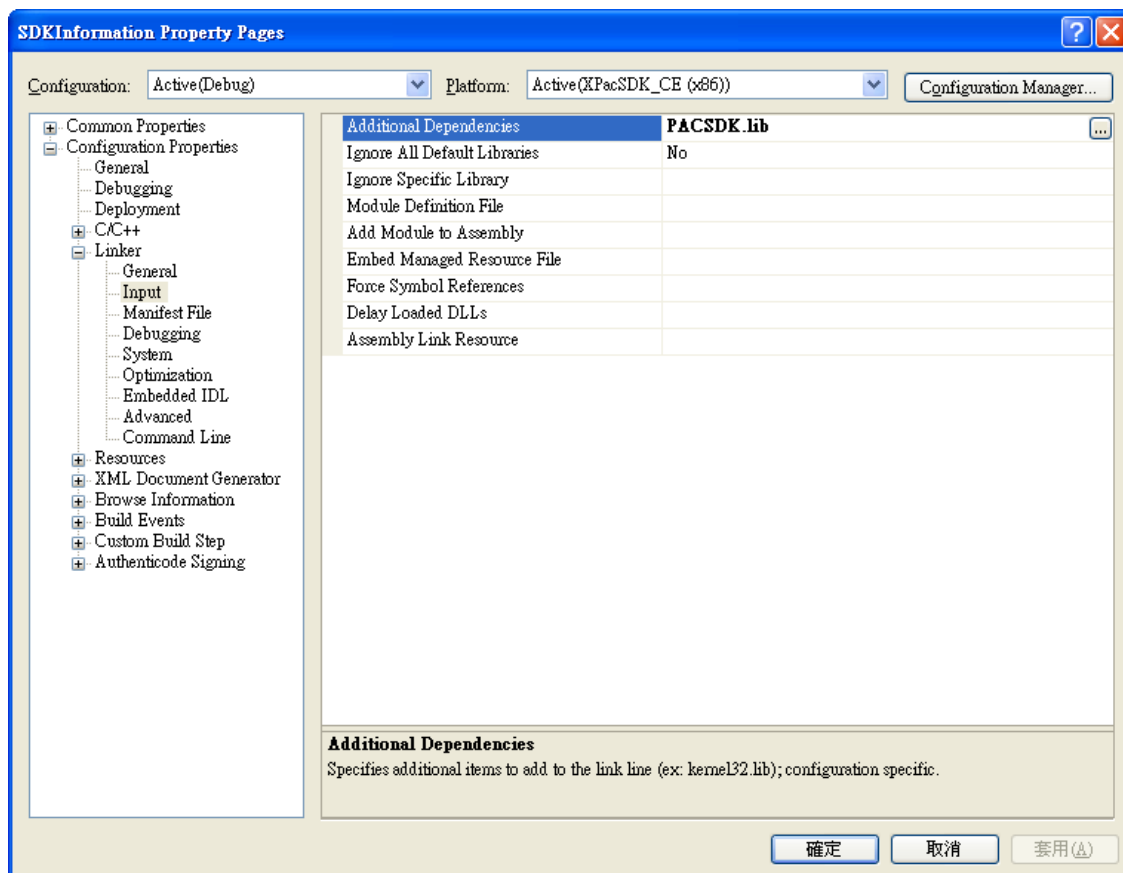

Step 4: In the right pane, choose the following path in the “Additional Include Directories” item

C:\Program Files\Windows CE Tools\SDKs\N2000_WINCE7_SDK\Include\X86

C:\Program Files\Microsoft Visual Studio 9.0\VC\ce7\atlmfc\include

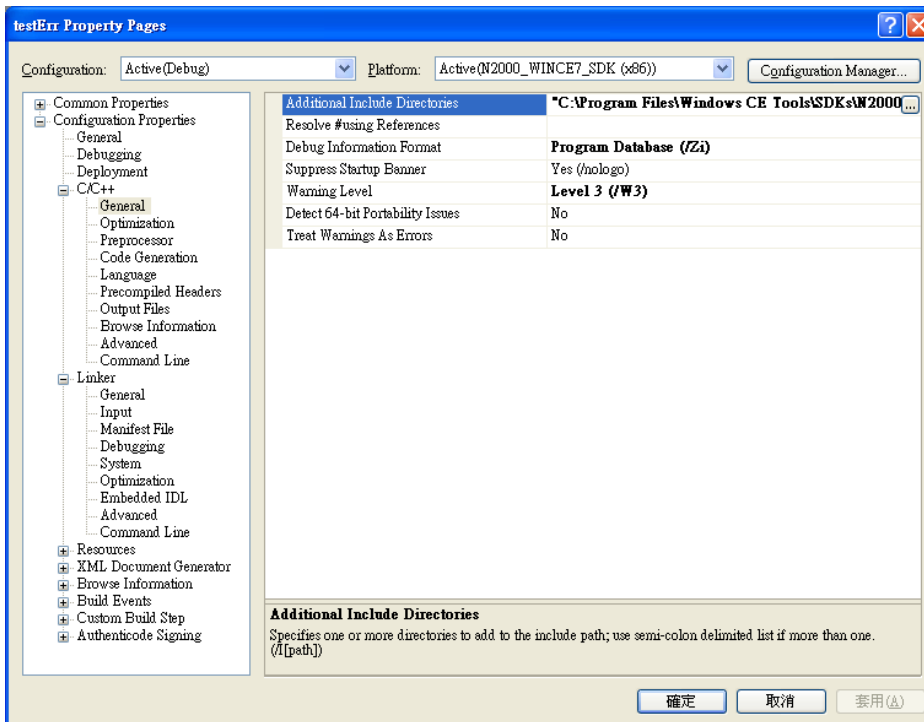

4.5.4. Add the Control to the Form

You can drag various controls from the Toolbox onto the form. These controls are not really "live"; they are just images that are convenient to move around on the form into a precise location.

After you add a control to your form, you can use the Properties window to set its properties, such as background color and default text. The values that you specify in the Properties window are the initial values that will be assigned to that property when the control is created at run time.

Step 1: In Resource View, expand the resources tree by opening the top level folder

**Step 2: Open the Dialog folder and then double-click the dialog resource name
IDD_SDKINFORMATION_DIALOG**

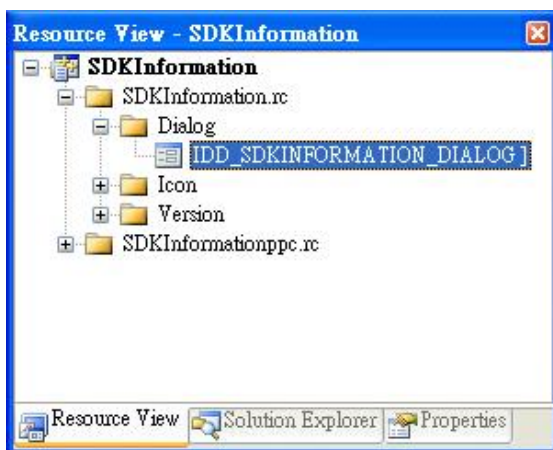

The resource editor appears in the right pane.

Step 3: From the Toolbox, drag a Button control onto the form

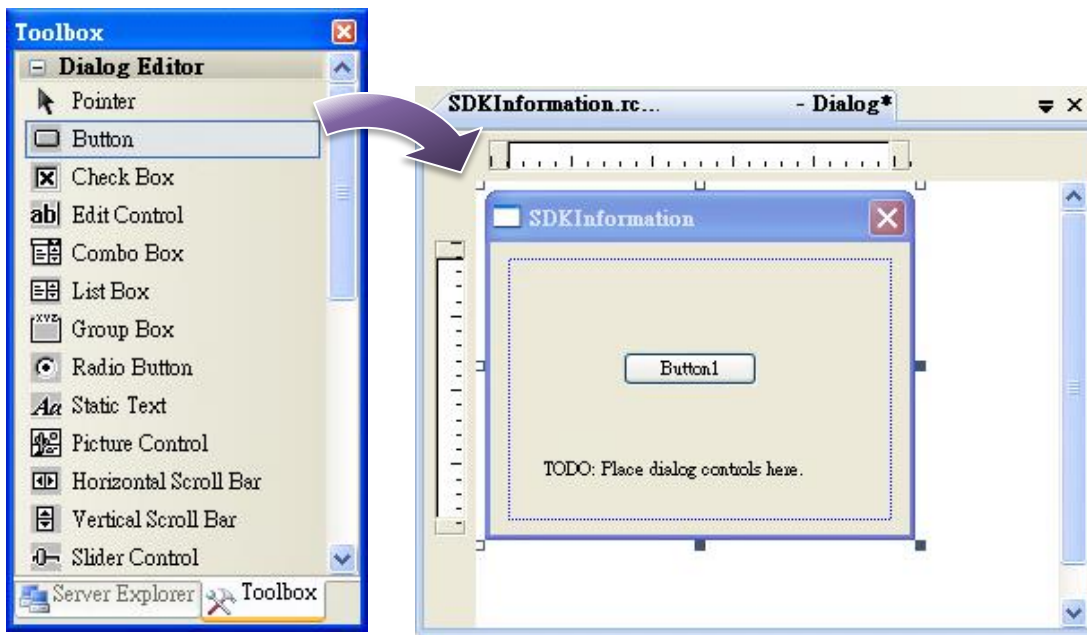

Step 4: Right-click the Button control, and then click Properties

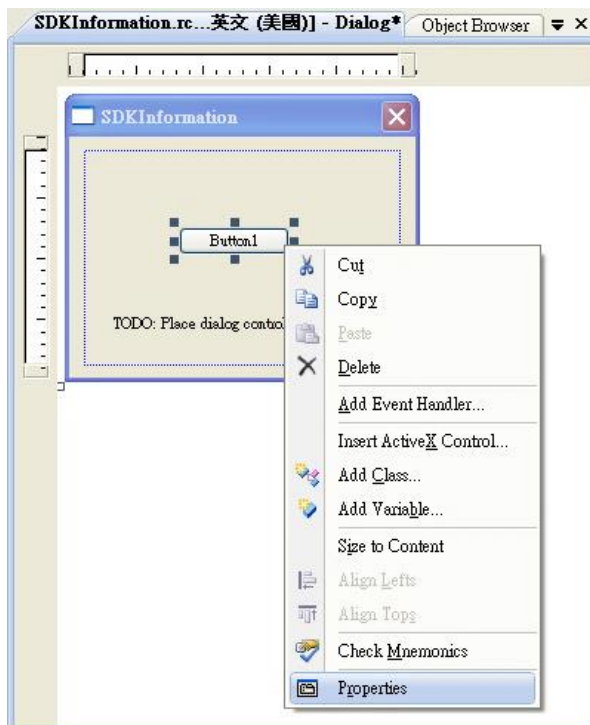

Step 5: In the Properties window, type Check the SDK version, and press ENTER to set the Text property

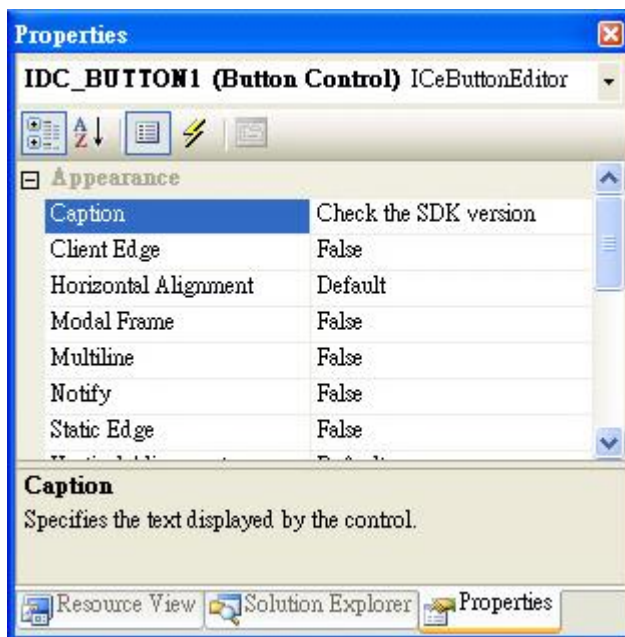

4.5.5. Add the Event Handling for the Control

You have finished the design stage of your application and are at the point when you can start adding some code to provide the program's functionality.

Step 1: Double-click the button on the form

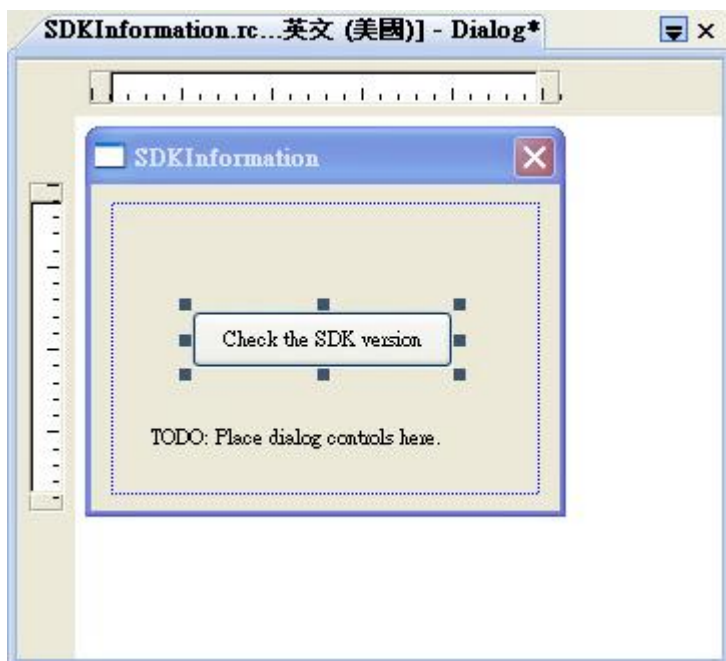

Step 2: Inserting the following code

```
char sdk_version[32];
TCHAR buf[32];
pac_GetSDKVersion(sdk_version);
pac-AnsiToWideString(sdk_version, buf);
MessageBox(buf,0,MB_OK);
```

```
void CSDKInformationDlg::OnBnClickedButton1()
{
    // TODO: Add your control notification handler code here
    char sdk_version[32];
    TCHAR buf[32];
    pac_GetSDKVersion(sdk_version);
    pac-AnsiToWideString(sdk_version, buf);
    MessageBox(buf,0,MB_OK);
}
```

Step 3: Inserting the following code into the header area

```
#include "PACSDK.h"
```

```
#include "stdafx.h"  
#include "SDKInformation.h"  
#include "SDKInformationDlg.h"  
#include "PACSDK.H"
```

4.5.6. Upload the Application to WinPAC

WinPAC supports FTP server service. You can upload files to WinPAC or download files from a public FTP server.

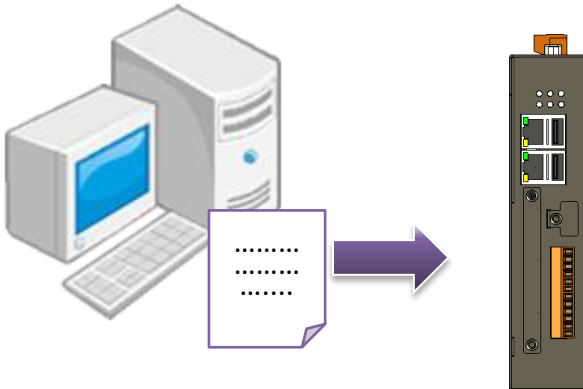

Step 1: On the Build menu, click Build SDKInformation

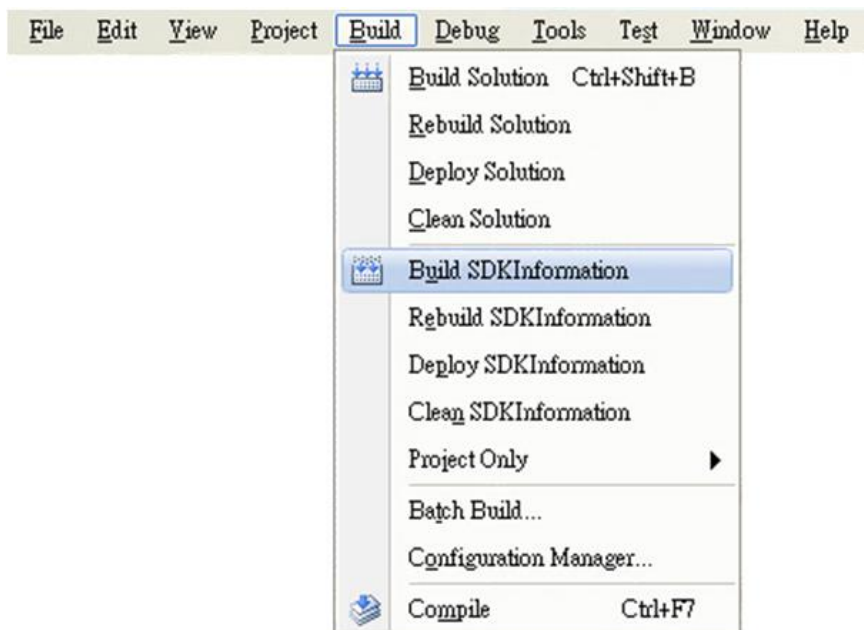

Step 2: Open the browser and type the IP address of WinPAC

Step 3: Upload the SDKInformation.exe application to WinPAC



4.5.7. Execute the Application on WinPAC

After uploading the application to WinPAC, you can just double-click it on WinPAC to execute it.



5. APIs and Demo Programs

This chapter provides a brief overview of PAC APIs and demo programs that have been designed for ICP DAS PACs.

ICP DAS provides a set of demo programs in different programming languages. You can examine the sample codes, which includes numerous comments, to familiarize yourself with the PAC APIs. This will allow developing your own applications quickly by modifying these demo programs.

For full usage information regarding the description, prototype and the arguments of the functions, please refer to the “PAC Standard API Manual”

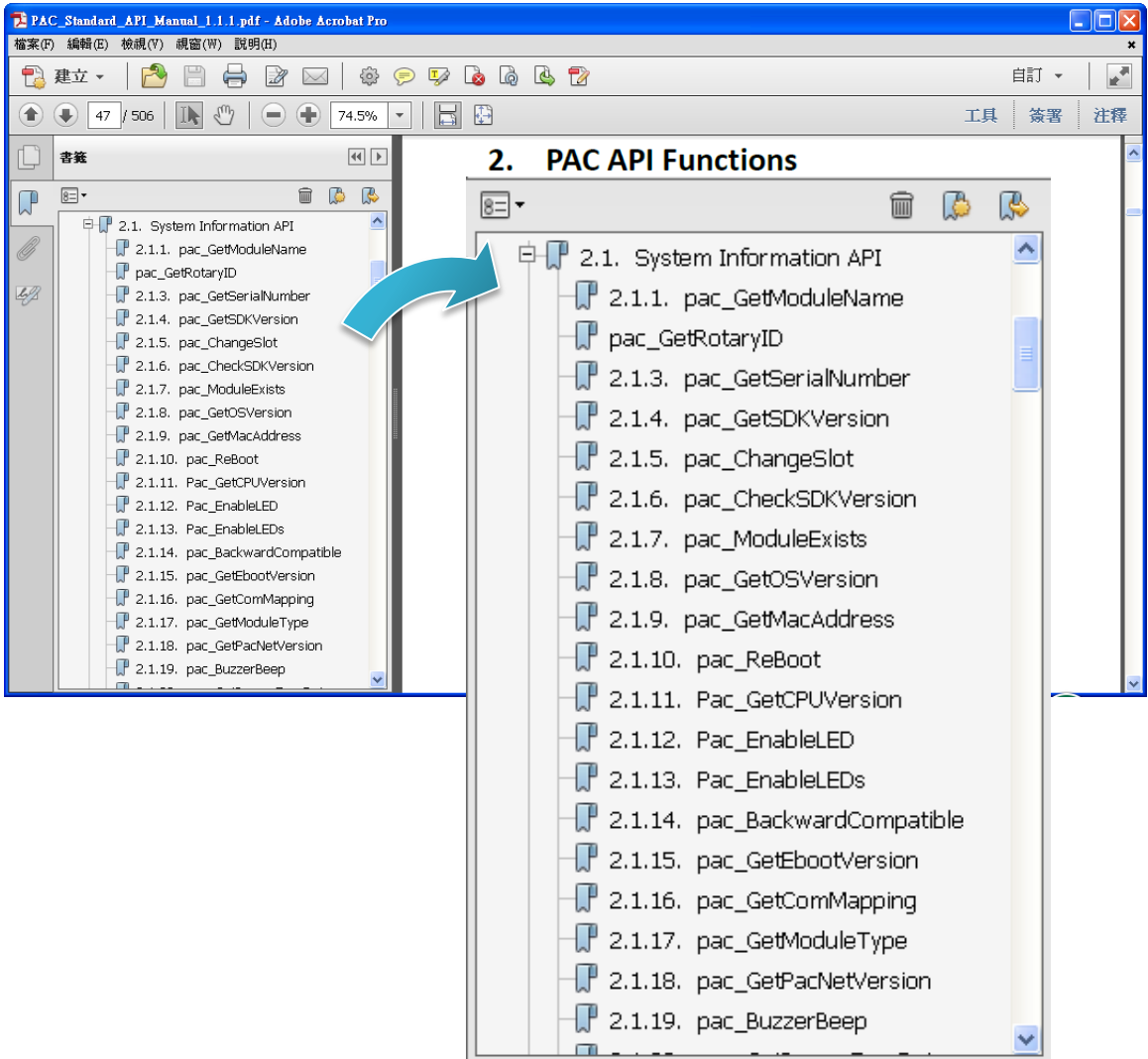

5.1. PAC Standard APIs

The diagram below shows the set of each system operation API provided in the PACSDK.

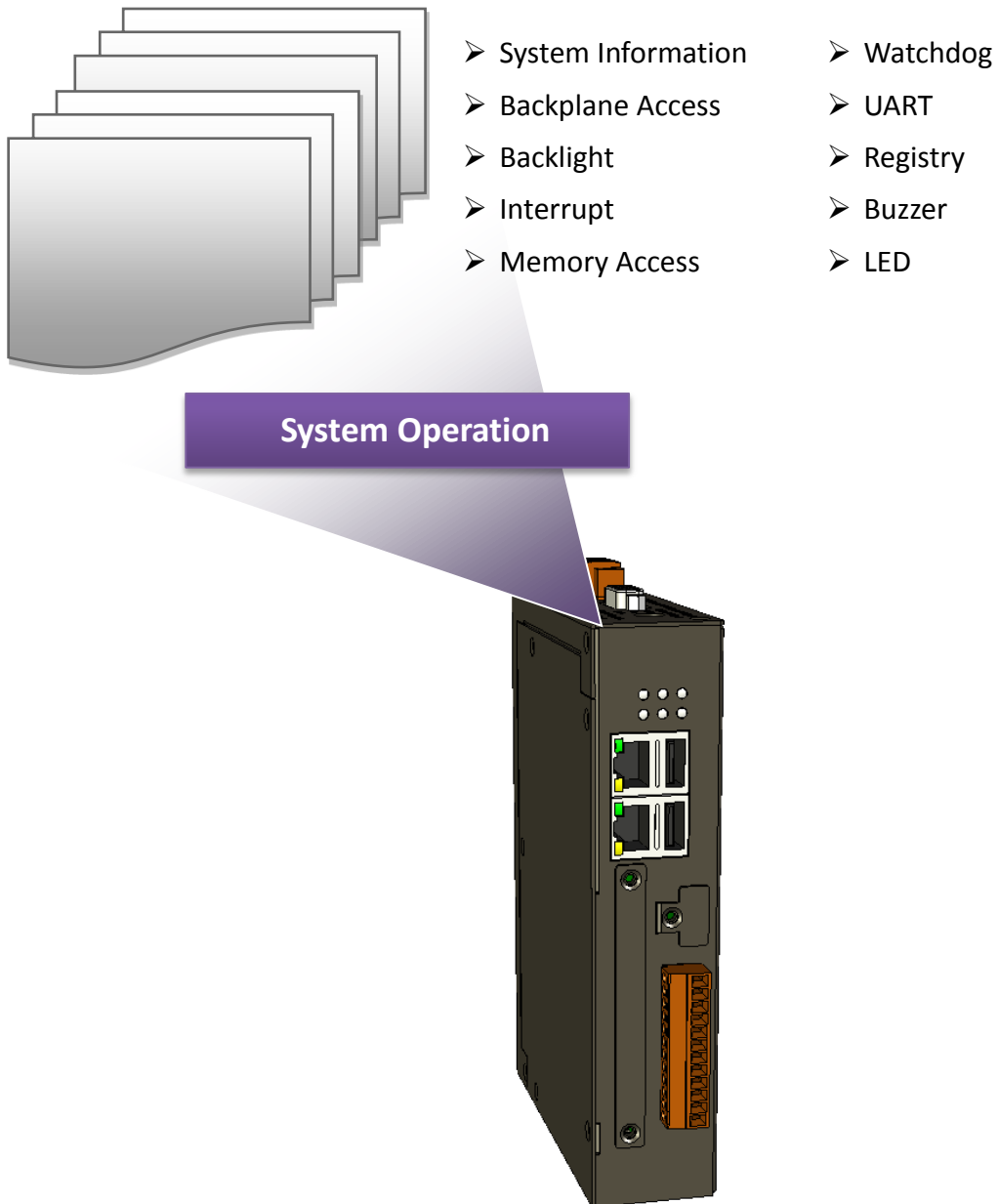

5.1.1. VB.NET Demo Programs for PAC Standard APIs

The PAC SDK includes the following demo programs that demonstrate the use of the PAC Standard APIs in a VB.NET language environment. The following demo programs can be found by downloading the latest version from ICP DAS web site.

For VB.NET applications, these demo programs can be obtained from:

http://ftp.icpdas.com/pub/cd/winpac_am335x/wp-2241/demo/pac/vb.net/standard/

Folder	Demo	Explanation
buzzer	buzzer	Shows how to make a simple buzzer beep.
DeviceInformation	DeviceInformation	Retrieves information about the OS version, CPU version, SDK version, etc.
GetRotaryID	GetRotaryID	Retrieves information about the status of the rotary switch
Memory	Memory	Shows how to read/write data values from/to the EEPROM or the backplane of the SRAM
MicroSD	MicroSD_Management	Shows how to manage the microSD
RealTimeTest	VB_UI_Call_VC_Realtime	Writes the managed code for the rich graphical user interface that does not require true real-time performance
	VBOOnly	Shows how to use the function of JIT compiler and garbage collector
Registry	Registry	Shows how to read/write data values from/to the registry
UART	UART	Shows how to read the name of a local I/O modules via a UART
WatchDog	WatchDog	Displays information about how to operate the watchdog

5.1.2. C# Demo Programs for PAC Standard APIs

The PAC SDK includes the following demo programs that demonstrate the use of the PAC Standard APIs in a C# language environment. The following demo programs can be found by downloading the latest version from ICP DAS web site.

For C# applications, these demo programs can be obtained from:

http://ftp.icpdas.com/pub/cd/winpac_am335x/wp-2241/demo/pac/c%23/standard/

Folder	Demo	Explanation
buzzer	buzzer	Shows how to make a simple buzzer beep.
DeviceInformation	DeviceInformation	Retrieves information about the OS version, CPU version, SDK version, etc.
GetRotaryID	GetRotaryID	Retrieves information about the status of the rotary switch
Memory	Memory	Shows how to read/write data values from/to the EEPROM or the backplane of the SRAM
MicroSD	MicroSD_Management	Shows how to manage the microSD
RealTimeTest	CSharp_UI_call_VC_Realtime	Writes the managed code for the rich graphical user interface that does not require true real-time performance
	CSharpOnly	Shows how to use the function of JIT compiler and garbage collector
Registry	Registry	Shows how to read/write data values from/to the registry
UART	UART	Shows how to read the name of a local I/O modules via a UART
WatchDog	WatchDog	Displays information about how to operate the watchdog

5.1.3. Visual C++ Demo Programs for PAC Standard APIs

The PAC SDK includes the following demo programs that demonstrate the use of the PAC Standard APIs in a Visual C++ language environment. The following demo programs can be found by downloading the latest version from ICP DAS web site.

For Visual C++ applications, these demo programs can be obtained from:

http://ftp.icpdas.com/pub/cd/winpac_am335x/wp-2241/demo/pac/vc2008/standard/

Folder	Demo	Explanation
buzzer	buzzer	Shows how to make a simple buzzer beep.
DeviceInformation	DeviceInformation	Retrieves information about the OS version, CPU version, SDK version, etc.
GetRotaryID	GetRotaryID	Retrieves information about the status of the rotary switch
Memory	Memory	Shows how to read/write data values from/to the EEPROM or the backplane of the SRAM
MultiRT	MultiRT	Shows how to manage the microSD
RealTimeTest	RealTimeTest	Writes the managed cod for the rich graphical user interface that does not require true real-time performance
Registry	Registry	Shows how to read/write data values from/to the registry
UART	UART	Shows how to read the name of a local I/O modules via a UART
WatchDog	WatchDog	Displays information about how to operate the watchdog

5.2. PAC IO APIs

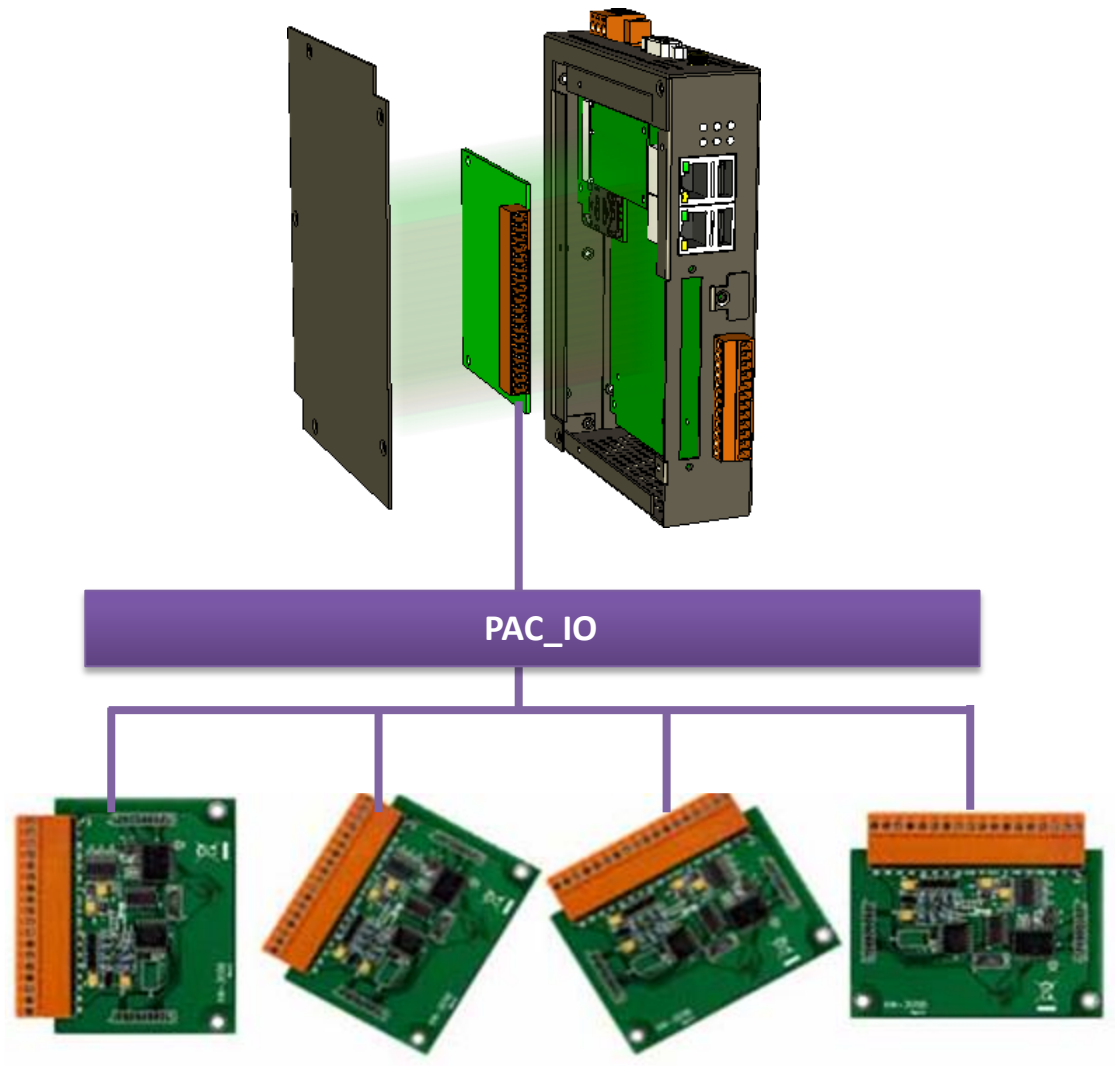

5.2.1. VB.NET Demo Programs for PAC Standard APIs

The PAC SDK includes the following demo programs that demonstrate the use of the PAC IO APIs in a VB.NET language environment. The following demo programs can be found by downloading the latest version from ICP DAS web site.

For VB.NET applications, these demo programs can be obtained from:

http://ftp.icpdas.com/pub/cd/winpac_am335x/wp-2241/demo/pac/vb.net/io/

Folder	Demo	Explanation
XVBoard/XV107	XV107_Modbus_RTU_Master_VB_demo	Shows how to use the XV107 module of the XV-board
Remote (I-7000 or I-87K modules in RU-87Pn I/O unit)		For full details regarding the remote I/O modules and its demos, please refer to: http://ftp.icpdas.com/pub/cd/winpac_am335x/wp-2241/demo/pac/appliable_demo_for_7k_module.pdf

5.2.2. C# Demo Programs for PAC Standard APIs

The PAC SDK includes the following demo programs that demonstrate the use of the PAC IO APIs in a C# language environment. The following demo programs can be found downloading the latest version from ICP DAS web site.

For C# applications, these demo programs can be obtained from:

http://ftp.icpdas.com/pub/cd/winpac_am335x/wp-2241/demo/pac/c%23/io/

Folder	Demo	Explanation
XVBoard/XV107	ModbusRTU_Master_Console	Shows how to use the XV107 module of the XV-board in console mode
	XV107_Modbus_RTU_Master_demo	Shows how to use the XV107 module of the XV-board
Remote (I-7000 or I-87K modules in RU-87Pn I/O unit)	For full details regarding the remote I/O modules and its demos, please refer to: http://ftp.icpdas.com/pub/cd/winpac_am335x/wp-2241/demo/pac/applicable_demo_for_7k_module.pdf	

5.2.3. Visual C++ Demo Programs for PAC Standard APIs

The PAC SDK includes the following demo programs that demonstrate the use of the PAC Standard APIs in a Visual C++ language environment. The following demo programs can be found downloading the latest version from ICP DAS web site.

For Visual C++ applications, these demo programs can be obtained from:

http://ftp.icpdas.com/pub/cd/winpac_am335x/wp-2241/demo/pac/vc2008/io/

Folder	Demo	Explanation
Remote (I-7000 or I-87K modules in RU-87Pn I/O unit)		For full details regarding the remote I/O modules and its demos, please refer to: http://ftp.icpdas.com/pub/cd/winpac_am335x/wp-2241/demo/pac/appliable_demo_for_7k_module.pdf

6. I/O Modules and SDK Selection

This chapter describes how to select a suitable I/O expansion module and the corresponding SDK library to be used for developing programs on WinPAC series devices.

Selecting an SDK Library for I/O Expansion

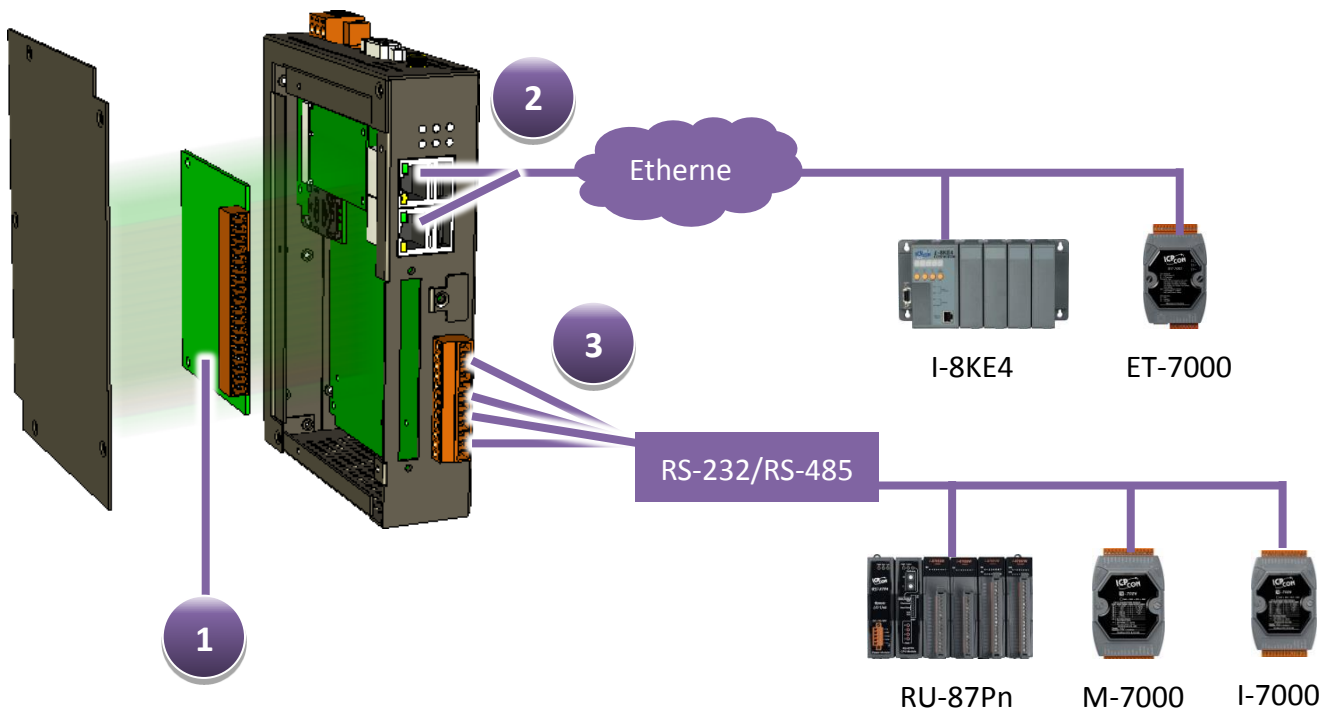

1 Local I/O Module (XV-Board)

There are more than 8 XV-Board available for expanding the function of the WP-2241M-CE7 The following table shows the appropriate SDK library to be used for I/O modules.

Module	Native SDK	.NET CF SDK
XV-Board	Modbus Demo	Modbus Demo

For more detailed information about these support modules, please refer to http://www.icpdas.com/root/product/solutions/hmi_touch_monitor/touchpad/xv-board_selection.html

2 RS-485 (I-7000 series and M-7000 series)

I-7000, M-7000, RU-87Pn and high profile I-87K series modules connect to WP-2241M-CE7 via a twisted-pair, multi-drop, 2-wire RS-485 network.

➤ I-7000 series I/O modules

Module	Native SDK	.NET CF SDK
I-7000 series	PACSDK.dll	PACNET.dll
I-7000 series with I-7088 (D)	PACSDK_PWM.dll	PACNET.dll

For full details regarding I-7000 series I/O modules and its demos, please refer to:

http://ftp.icpdas.com/pub/cd/winpac_am335x/wp-2241/demo/pac/applicable_demo_for_7k_module.pdf

➤ M-7000 series I/O modules

Module	Native SDK	.NET CF SDK
M-7000 series	Modbus Demo	Modbus Demo

For more detailed information about M-7000 series modules using Modbus protocol and its demos, please refer to:

http://ftp.icpdas.com/pub/cd/winpac_am335x/wp-2241/demo/nmodbus/

➤ RU-87Pn + I-87K series I/O modules

Module	Native SDK	.NET CF SDK
RU-87Pn + I-87K	PACSDK.dll	PACNET.dll

➤ Other specified I/O

Module	Native SDK	.NET CF SDK
I-7088W	PACSDK_PWM.dll	PACNET.dll

3 Ethernet (ET-7000 series and I-8KE4/8-MTCP)

The Ethernet I/O devices available include ET-7000 and I-8KE4/8-MTCP, and support the Modbus/TCP communication protocol.

Module	Native SDK	.NET CF SDK
ET-7000	Modbus Demo	Modbus Demo
I-8KE4/8-MTCP	Modbus Demo	Modbus Demo

For more detailed information about ET-7000 and I-8KE4/8-MTCP series modules using Modbus protocol and its demos, please refer to:

http://ftp.icpdas.com/pub/cd/winpac_am335x/wp-2241/demo/nmodbus/

7. WP-2241M-CE7 Updates

This chapter provides information of the WinPAC OS and SDKs, and a guided tour that demonstrates the steps needed to update the WinPAC OS and SDKs.

ICP DAS will continue to add additional features to WinPAC SDK and OS in the future, so we advise you to periodically check the ICP DAS web site for the latest updates.

Both the files of OS updates and SDK updates can be found by downloading the latest version from ICP DAS web site.

http://ftp.icpdas.com/pub/cd/winpac_am335x/wp-2241/

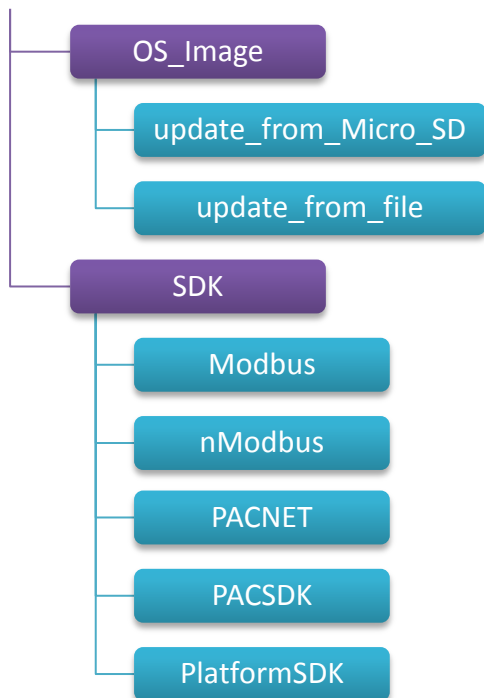

7.1. OS Updates

OS updates are part of the WP-2241M-CE7 updates services to provide additional and more efficient features and functionality for WP-2241M-CE7 operating system.

The updates files of OS image can be found by downloading the latest version from ICP DAS web site.

http://ftp.icpdas.com/pub/cd/winpac_am335x/wp-2241/os_image/

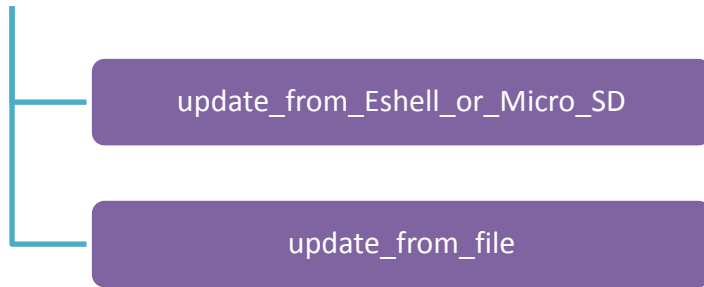

There are two ways to update the OS:

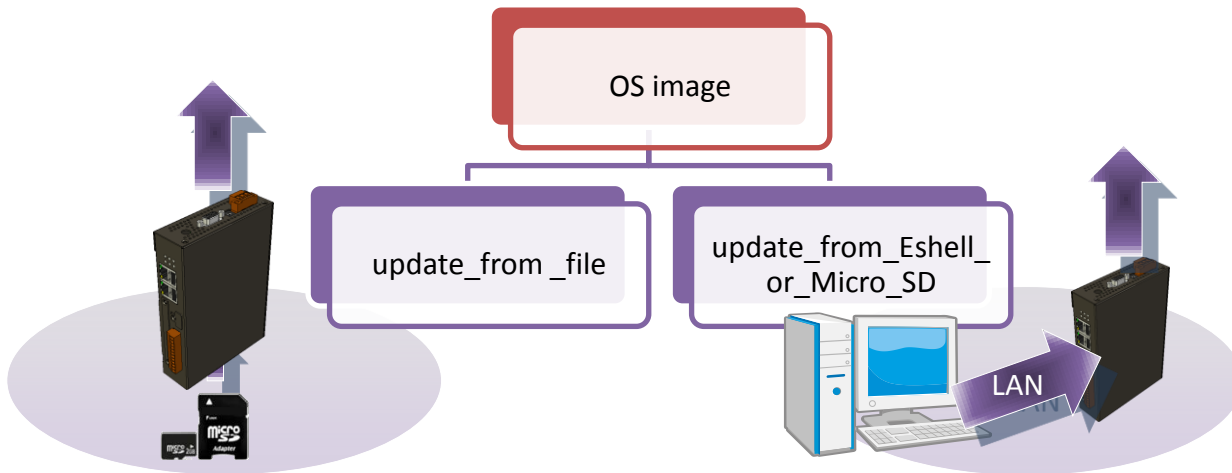

1. Update from eshell (Please refer to section 7.1.1)

(We recommend that you use this one for more quicker and easier to update)

2. Update from micro_SD (Please refer to section 7.1.2)

7.1.1. OS Updates using Eshell

By default, the OS updates via LAN. Therefore, to update the OS image, make sure LAN is connected to the PC.

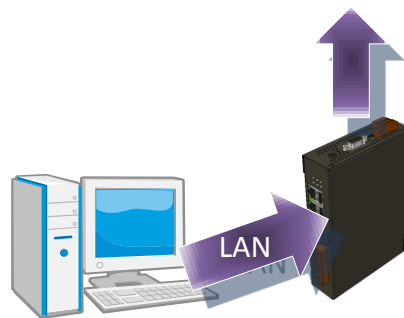

Step 1: Get the latest version of the installation package file and then unzip it

The latest version of the installation package file can be found from ICP DAS web site.
http://ftp.icpdas.com/pub/cd/winpac_am335x/wp-2241/os_image/update_from_eshell_or_micro_sd/

Step 2: Run the registry clear.exe

The registry.exe can be found by downloading the latest version from ICP DAS web site.
http://ftp.icpdas.com/pub/cd/winpac_am335x/wp-2241/pc_tools/eshell

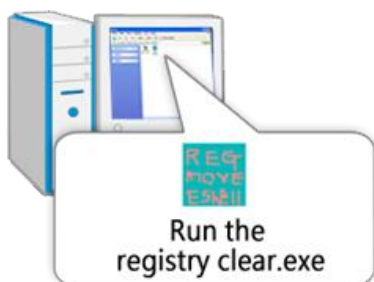

Step 3: Place the rotary switch in position 3, OS update mode

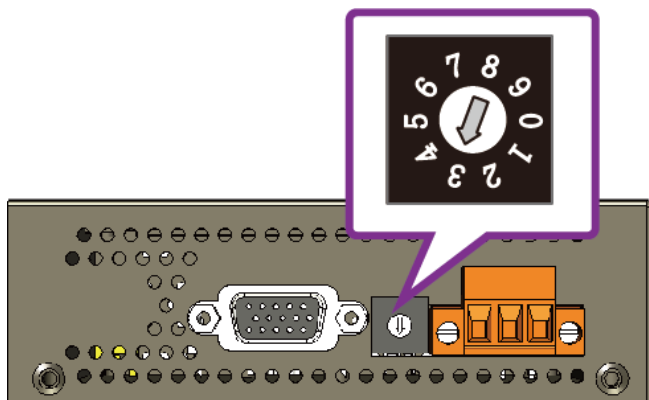

Step 4: Run the ESHELL.exe, and then restart the WP-2241M-CE7



ESHELL

The ESHELL.exe can be found by downloading the latest version from ICP DAS web site.

http://ftp.icpdas.com/pub/cd/winpac_am335x/wp-2241/pc_tools/eshell

Step 5: Select the device which you want to update the OS image, and then click OK

Select the device name which you want to update the OS image from the list.

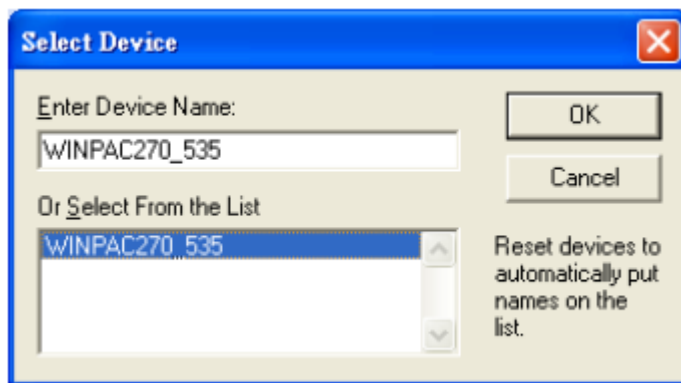

Step 6: Select the latest version of the OS image file

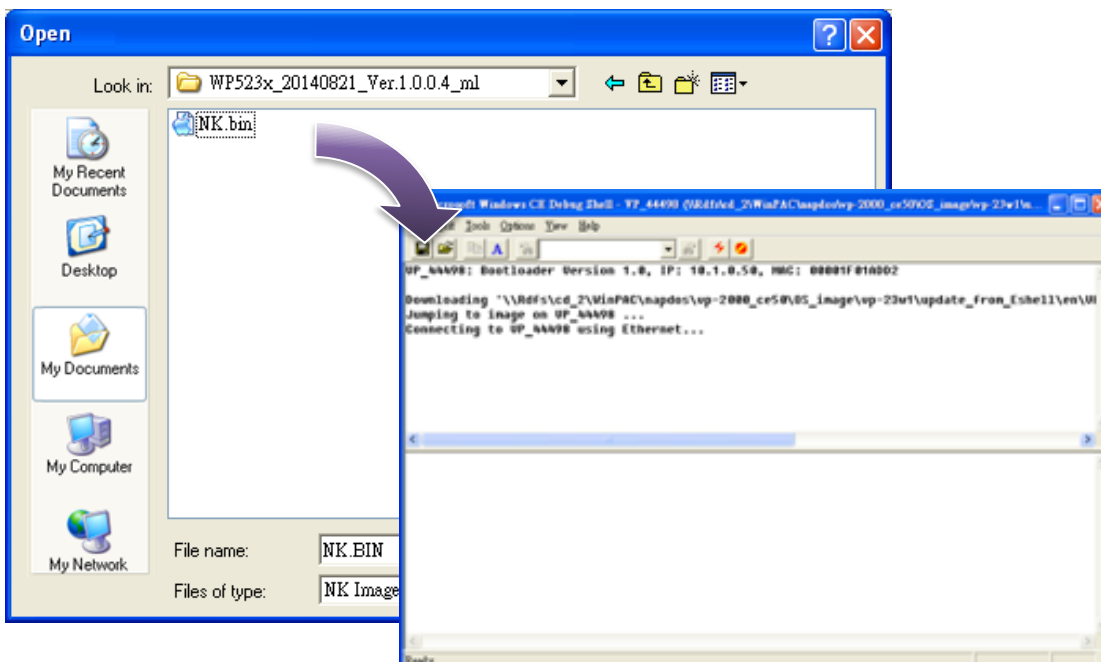

Step 7: Once the procedure is completed, the “Warning !” dialog box will appear as below shown, then turn the rotary switch in position 0, normal mode

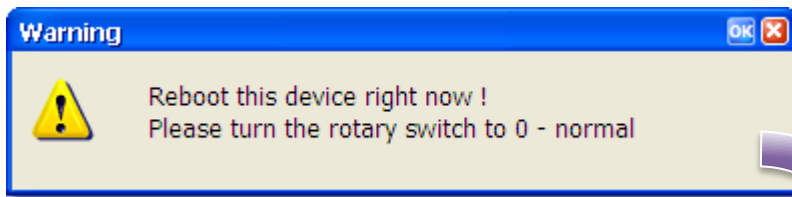

Step 8: Click the OK button

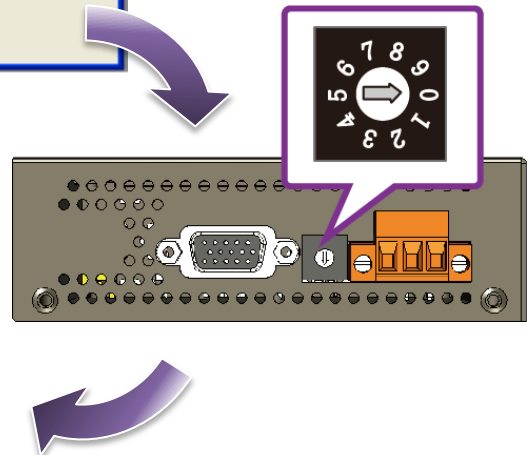
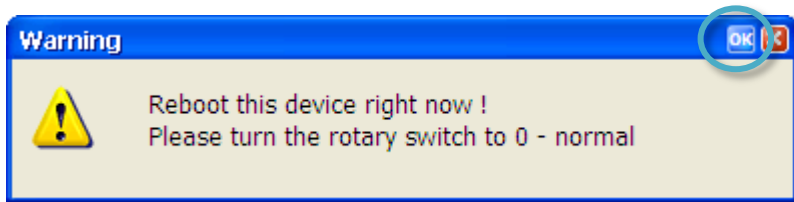

Step 9: Check the OS version

Start the PAC Utility, and then select the “Device Information” tab to check the current OS version.

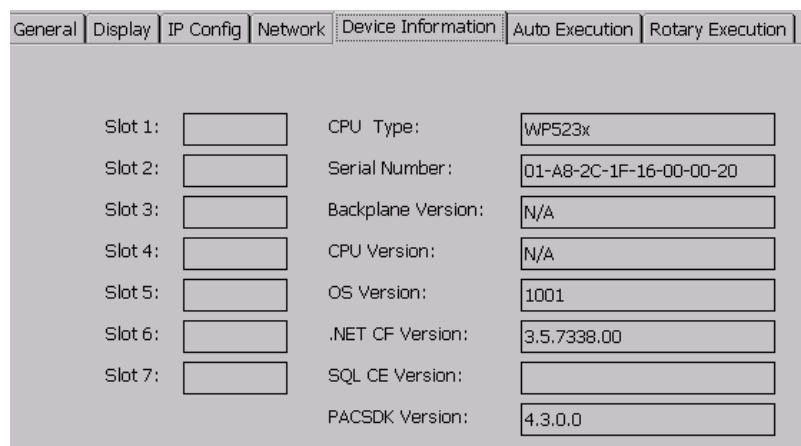
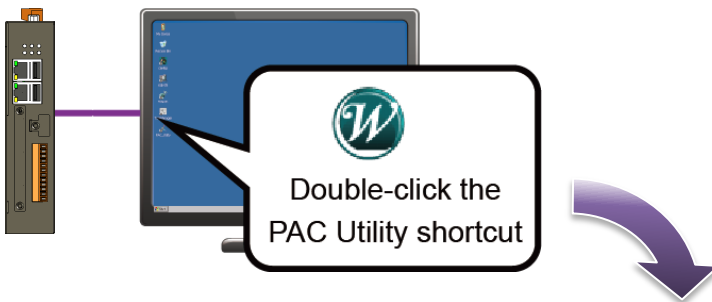

7.1.2. OS Updates using micro_SD

The microSD card can be used to reinstall the WP-2241M-CE7 OS image to factory default settings in the event of the WP-2241M-CE7 failure.

Step 1: Get the latest version of the installation package file, then unzip the file, and then copy them to microSD card

The latest version of the installation package file can be found from ICP DAS web site.

http://ftp.icpdas.com/pub/cd/winpac_am335x/wp-2241/os_image/update_from_eshell_or_micro_sd/

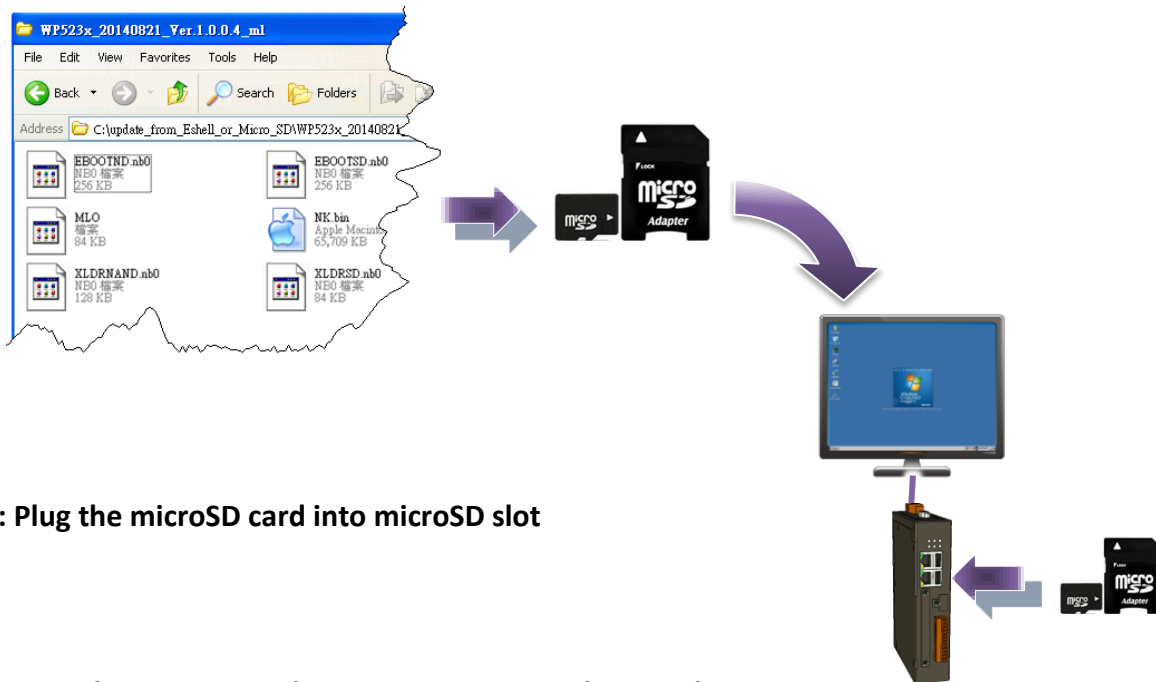

Step 2: Plug the microSD card into microSD slot

Step 3: Turn the rotary switch in position 5, OS update mode

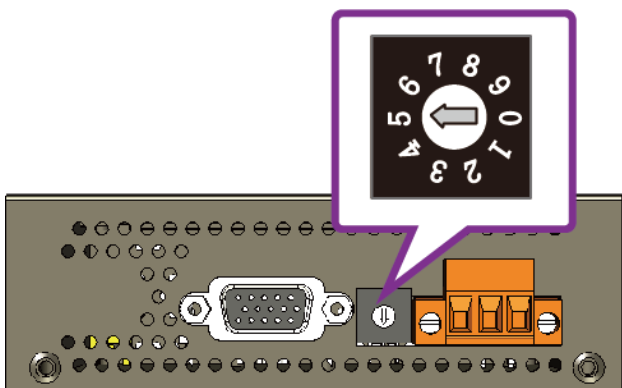

Step 4: Reboot the WP-2241M-CE7

Step 5: Wait a few minutes for the following desktop to be displayed



Step 6: Turn the rotary switch in position 0, normal mode

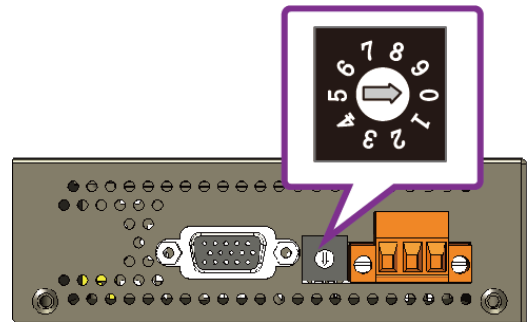

Step 7: Reboot the WP-2241M-CE7

Step 8: Check the OS version

Start the PAC Utility, and then select the “Device Information” tab to check the current OS version.

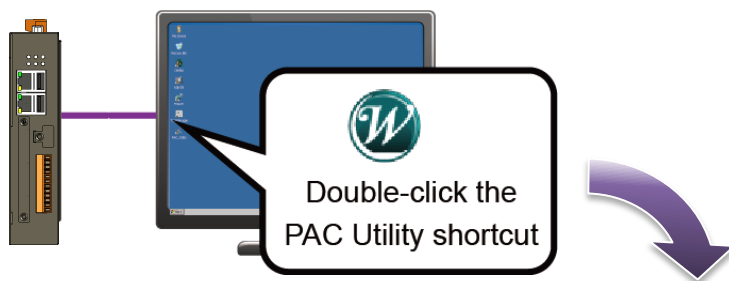

General	Display	IP Config	Network	Device Information	Auto Execution	Rotary Execution
Slot 1:	<input type="text"/>	CPU Type:	<input type="text" value="WP523x"/>			
Slot 2:	<input type="text"/>	Serial Number:	<input type="text" value="01-A8-2C-1F-16-00-00-20"/>			
Slot 3:	<input type="text"/>	Backplane Version:	<input type="text" value="N/A"/>			
Slot 4:	<input type="text"/>	CPU Version:	<input type="text" value="N/A"/>			
Slot 5:	<input type="text"/>	OS Version:	<input type="text" value="1001"/>			
Slot 6:	<input type="text"/>	.NET CF Version:	<input type="text" value="3.5.7338.00"/>			
Slot 7:	<input type="text"/>	SQL CE Version:	<input type="text"/>			
		PACSDK Version:	<input type="text" value="4.3.0.0"/>			

7.2. SDK Updates

SDK updates are part of the WP-2241M-CE7 update services to provide additional and more efficient features and functionality for WP-2241M-CE7 operating system.

The updates files of SDK files can be found by downloading the latest version from ICP DAS web site.

http://ftp.icpdas.com/pub/cd/winpac_am335x/wp-2241/sdk/

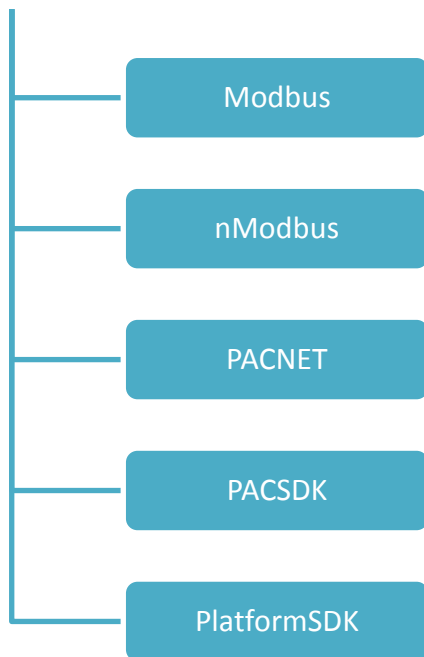

7.2.1. SDK Updates for VB.NET or C#

You can just change the old one with a new one.

Step 1: Get the latest version of the PACNET.dll

The latest version of the PACNET. dll can be obtained from ICP DAS web site.

http://ftp.icpdas.com/pub/cd/winpac_am335x/wp-2241/sdk/pacnet/

Step 2: Copy the PACNET.dll file to PC and WP-2241M-CE7

The DLL files on PC are located at anywhere only the solution can reference it.

The DLL files on WP-2241M-CE7 are located at the same directory as the .exe file.

7.2.2. SDK Updates for C++

You can just change the old one with a new one.

Step 1: Get the latest version of the VC++ components

The latest version of the VC++ components can be obtained from:

http://ftp.icpdas.com/pub/cd/winpac_am335x/wp-2241/sdk/pacsdk/

Step 2: Copy the latest version of header files and libraries to Host PC

The header files are located at:

C:\Program Files\Windows CE Tools\SDKs\AM335x_WINCE7_SDK\Include\Armv4i

The libraries are located at:

C:\Program Files\Windows CE Tools\SDKs\AM335x_WINCE7_SDK\Lib\ARMv4I

Step 3: Copy the latest version of DLL files to WinPAC

The DLL files are located at:

\System_Disk\ICPDAS\System

Appendix. A. Tips – How to

A.1. How to Online Debug the WP-2241M-CE7 Program

Here are step by step instructions on how to online debug the WP-2241M-CE7 program.

Tips & Warnings



Before starting online debug the WP-2241M-CE7 program, make sure that the WP-2241M-CE7 SDK has been installed correctly.

For more information on how to install the WP-2241M-CE7 SDK, please refer to 4.2. Installing WP-2241M-CE7 SDK.

Step 1: Copy the following files to the \System_Disk\icpdas\system on the WP-2241M-CE7

By default, these files are located on the development computer at C:\Program Files\Common Files\Microsoft Shared\CoreCon\1.0\Target\wce400\<CPU>.

- clientshutdown.exe
- CMAccept.exe
- ConmanClient2.exe
- eDbgTL.dll
- TcpConnectionA.dll

Step 2: Run the ConmanClient2.exe and then CMAccept.exe on the WP-2241M-CE7

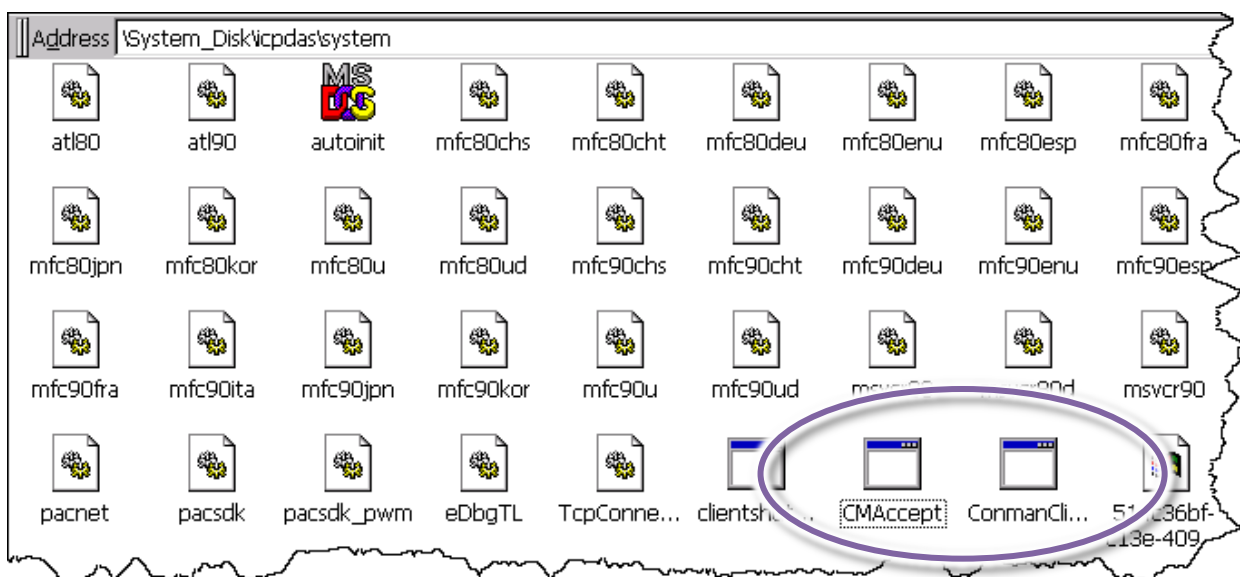

Step 3: On the Tools menu, click the Options...

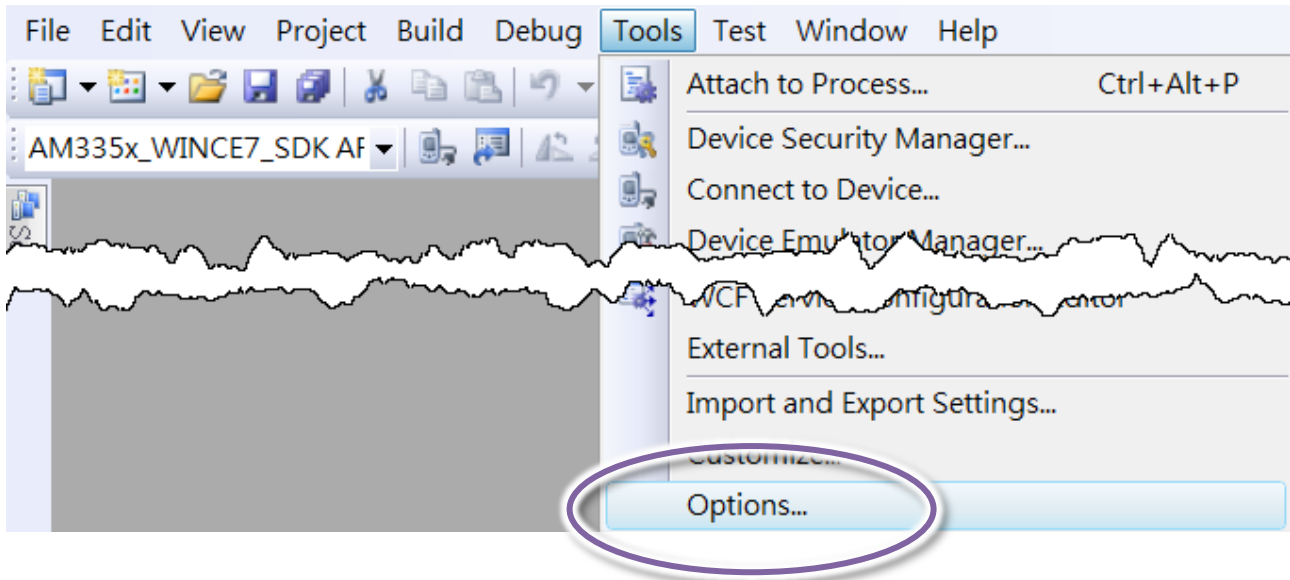

Step 4: In the left pane, expand Device Tools node and select Devices

Step 5: In the Show devices for platform:, select AM335x_WINCE7_SDK and then click Properties

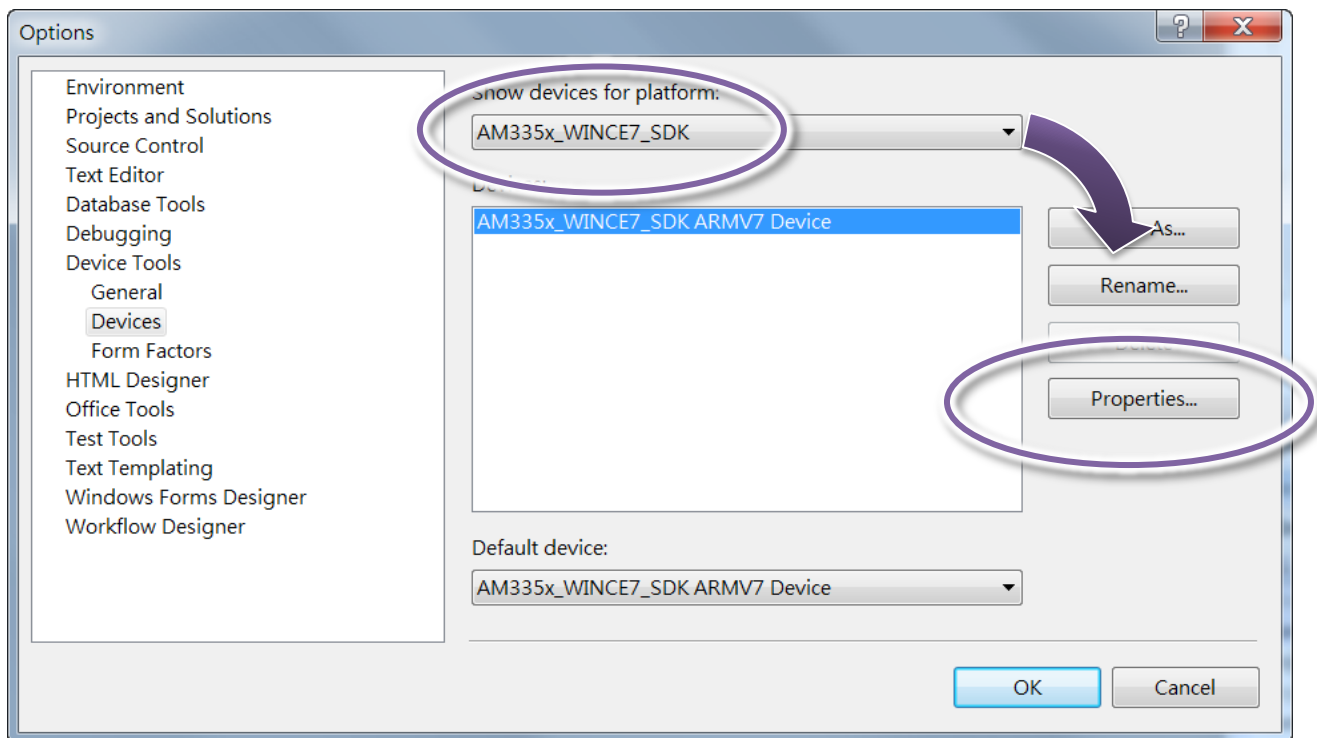

Step 6: Click the Configure...

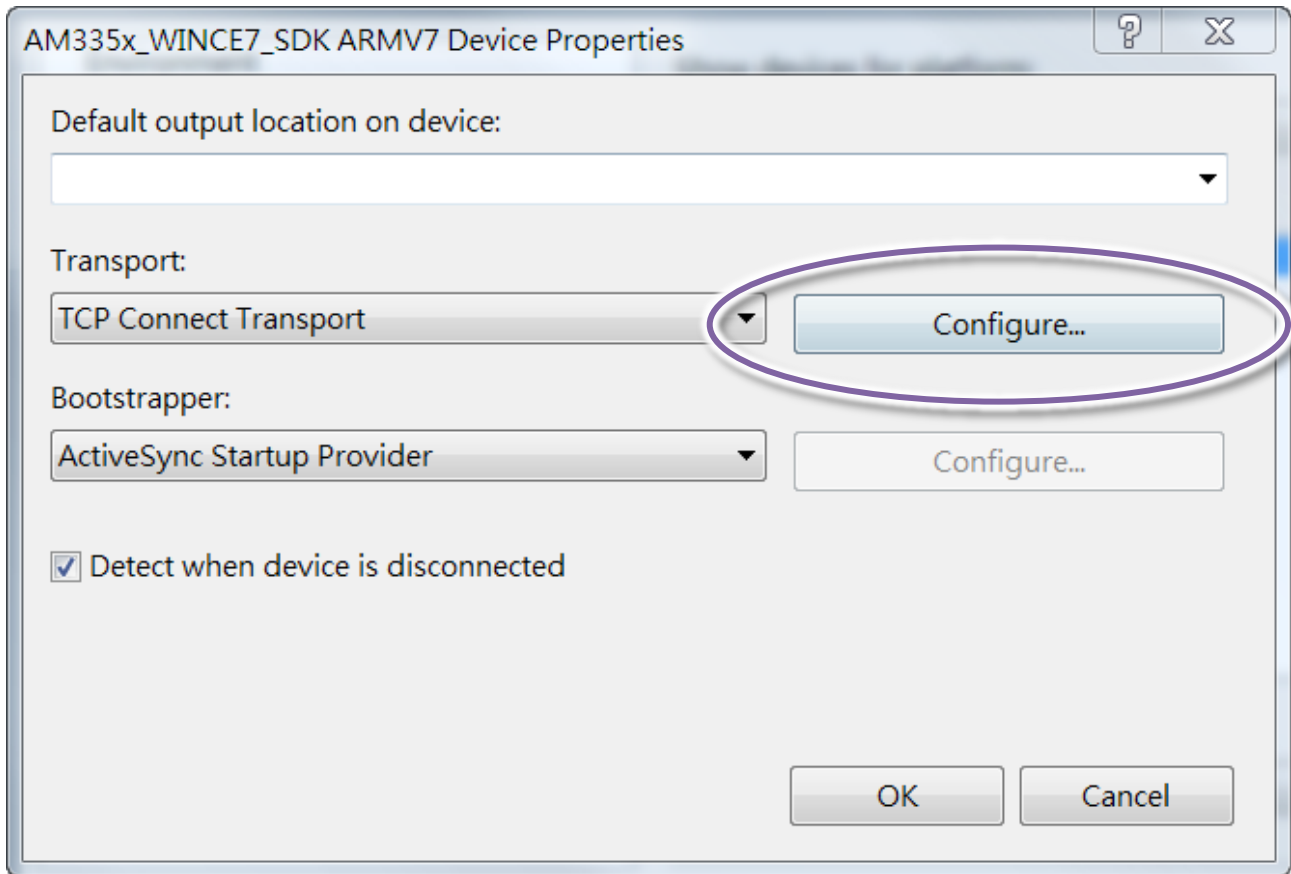

Step 7: Select the Use specific IP address;, and then type the IP address of WP-2241M-CE7

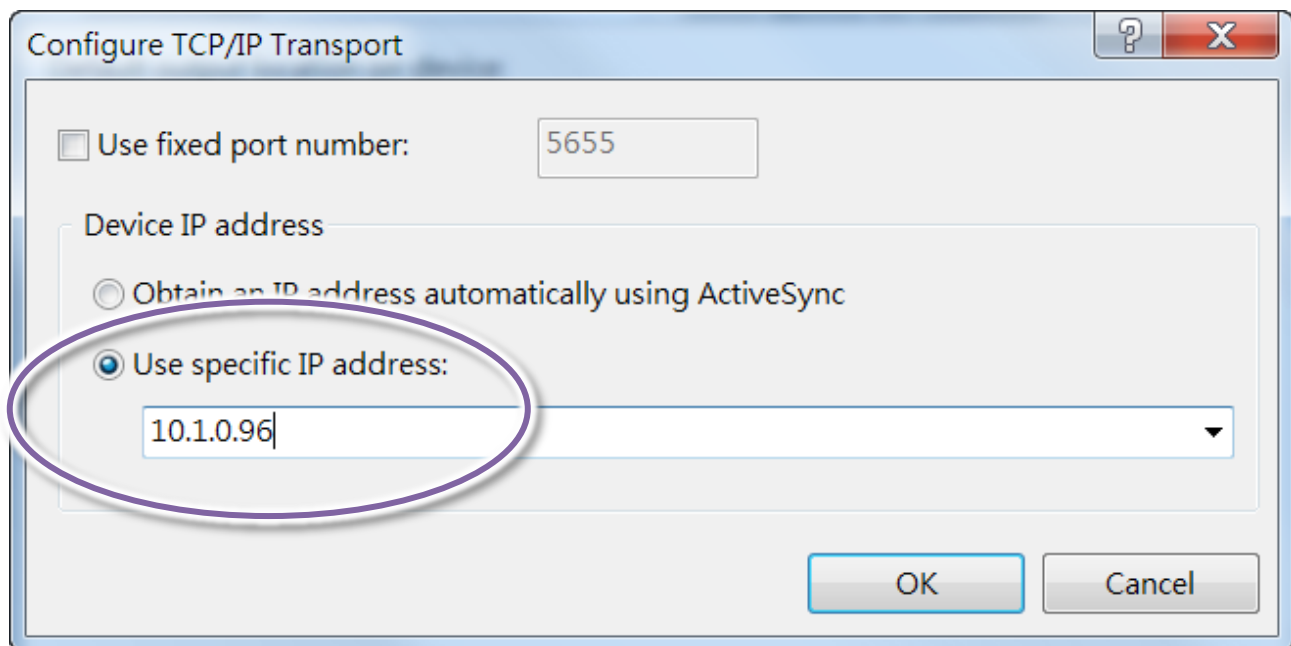

Step 8: Click the OK, and then click OK to end the dialog

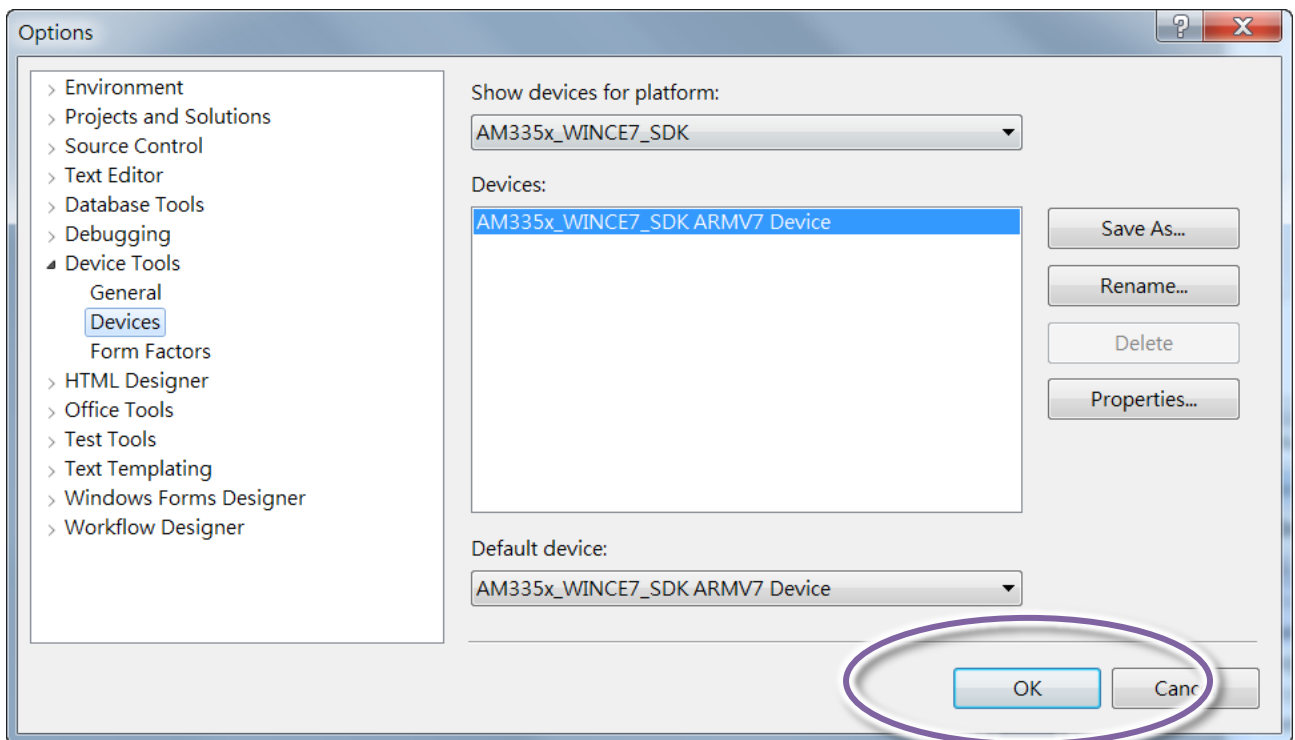
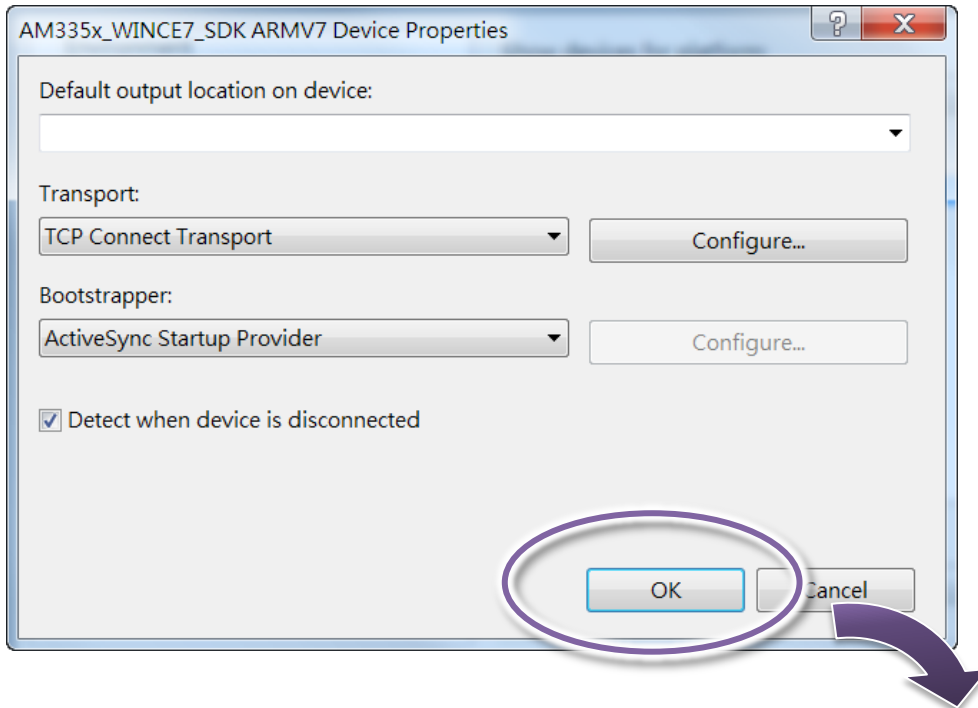

Step 9: On the Tools menu, click the Connect to Device...

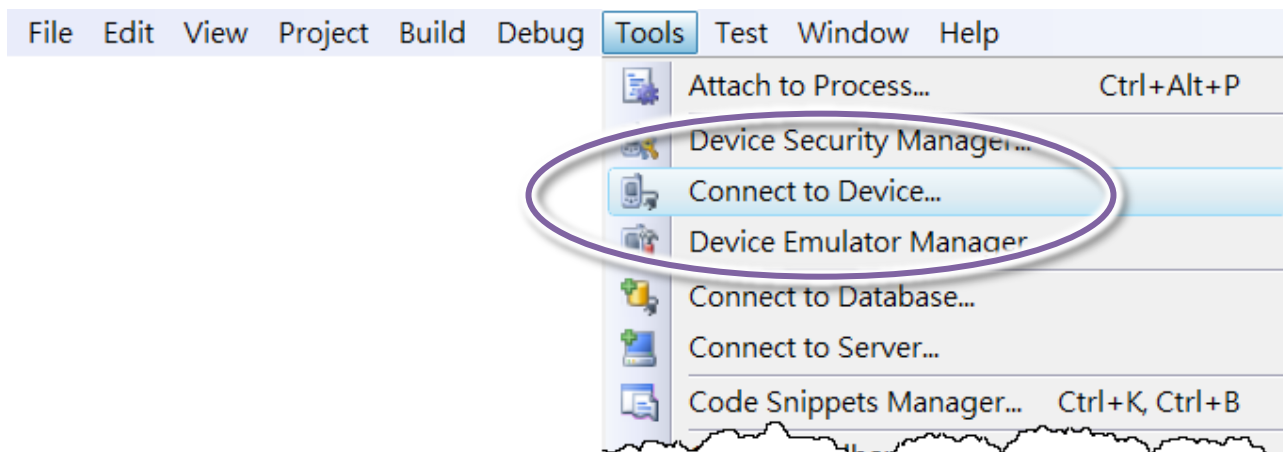

Step 10: Wait for the connection to be established

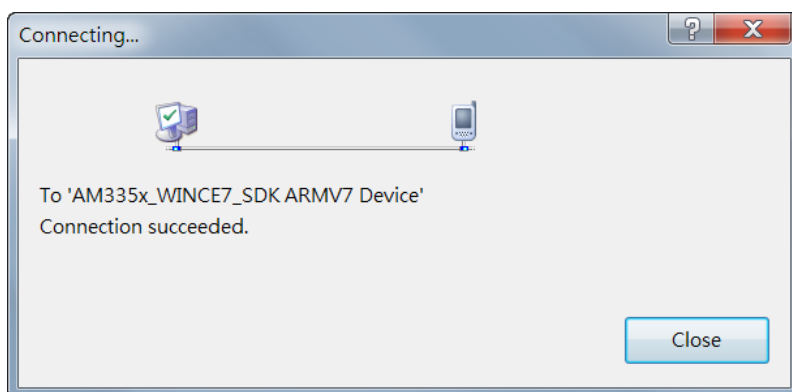

Tips & Warnings



If the connection fails, as shown below, please repeat the step 2 to step 9 to try it again.

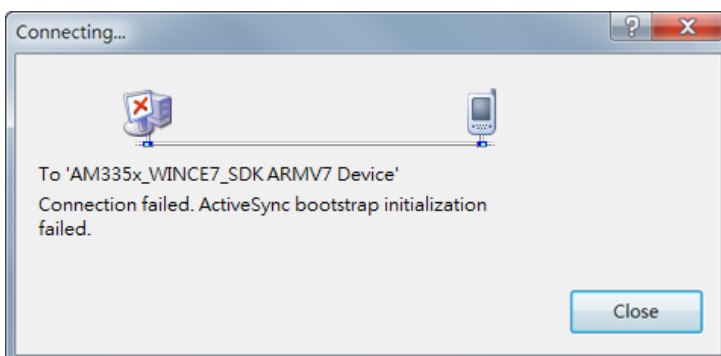

A.2. How to Automatically Synchronize WinPAC Clock

You can synchronize your WinPAC clock with an Internet time server.

If synchronization is enabled, the WinPAC clock is synchronized with an Internet time server.

Step 1: Double-click the PAC Utility on the desktop

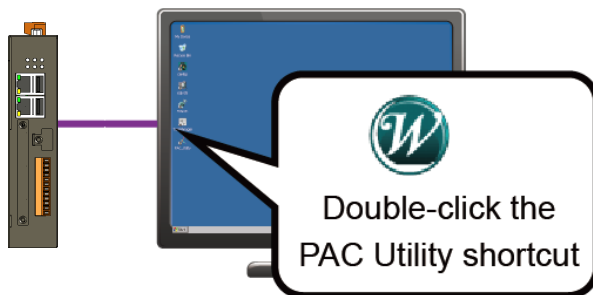

Step 2: On the General tab, press Configure button

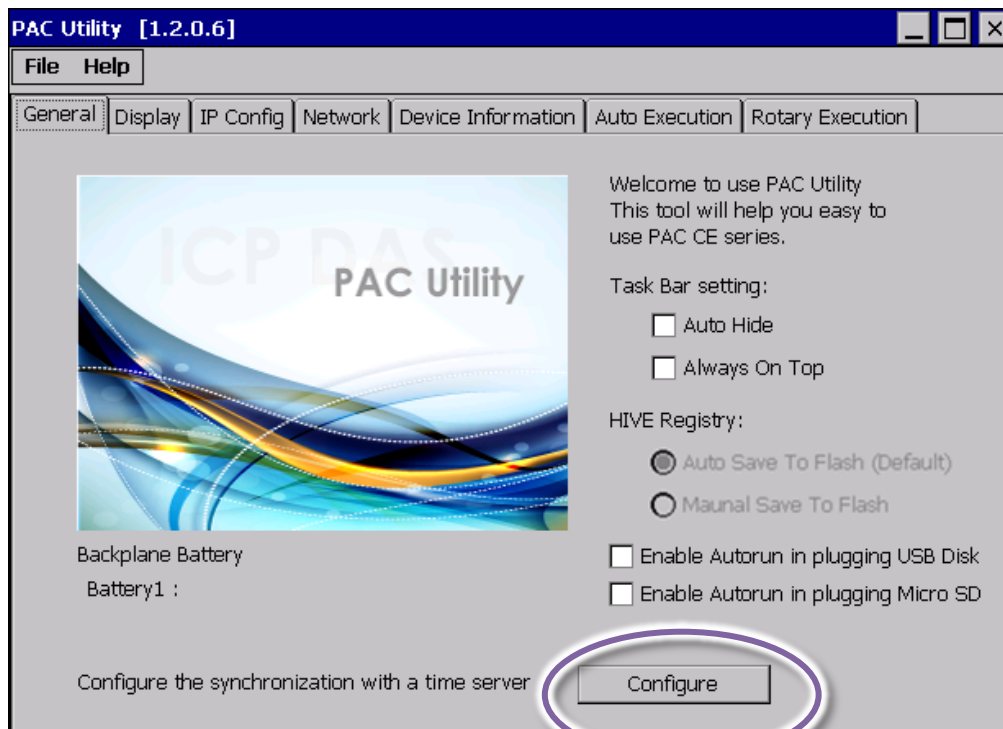

Step 3: Select the domain name from the Server drop-down list, and then enter a value in the Autoupdate Frequency field

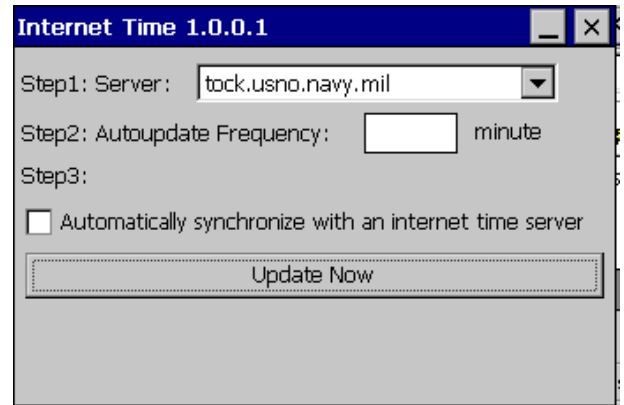

Step 4: Check the Automatically synchronize with an internet time server check box

Step 5: On the File menu, click Save and Reboot

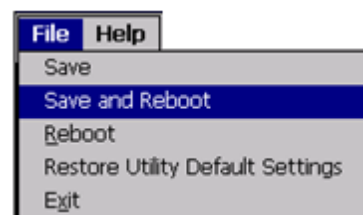

Step 6: The WinPAC will automatically synchronize with an internet time server regularly

Step 7: Click the Update Now button to synchronize WinPAC clock immediately

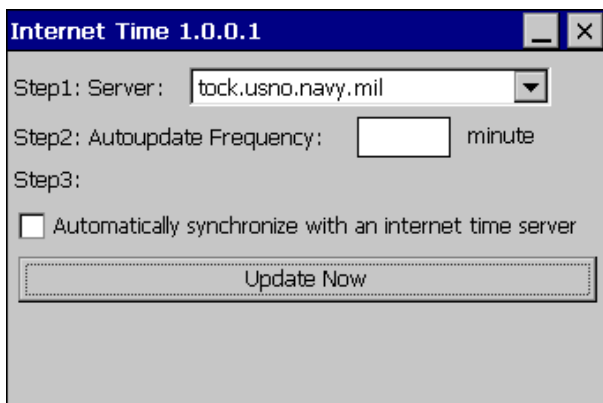

A.3. How to use User Account Control in WinPAC

A.3.1. How to Create an User Account

Here are step by step instructions on how to add a user account.

Step 1: Double-click the PAC Utility on the desktop

Step 2: On the Login tab of the Network tab, click Login tab, type the User Name and Password, and then click Add button

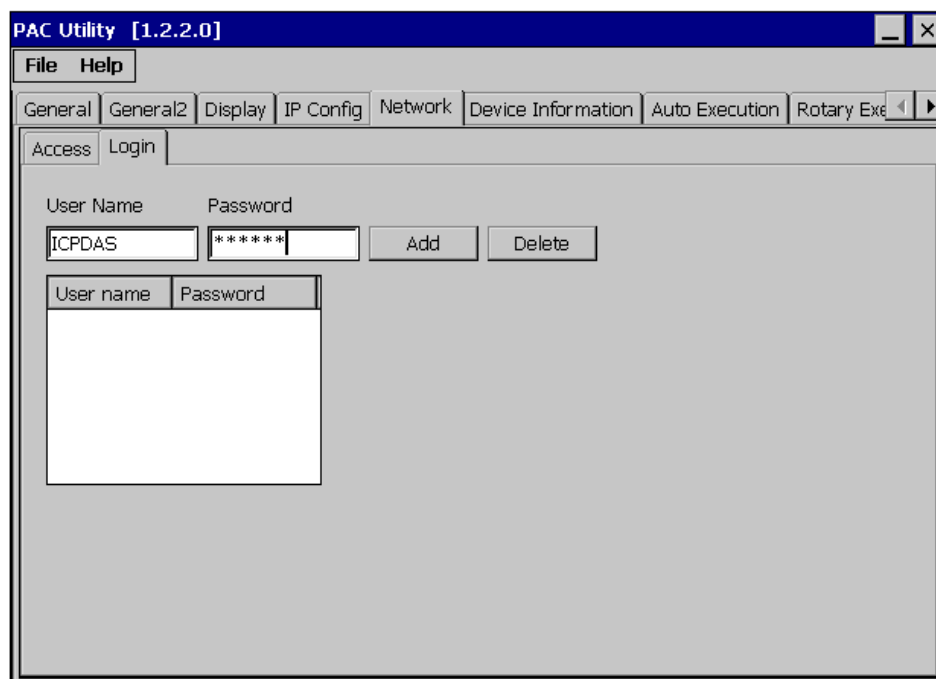

Step 3: The user has been added to the allowed under the remote login and included in the following list

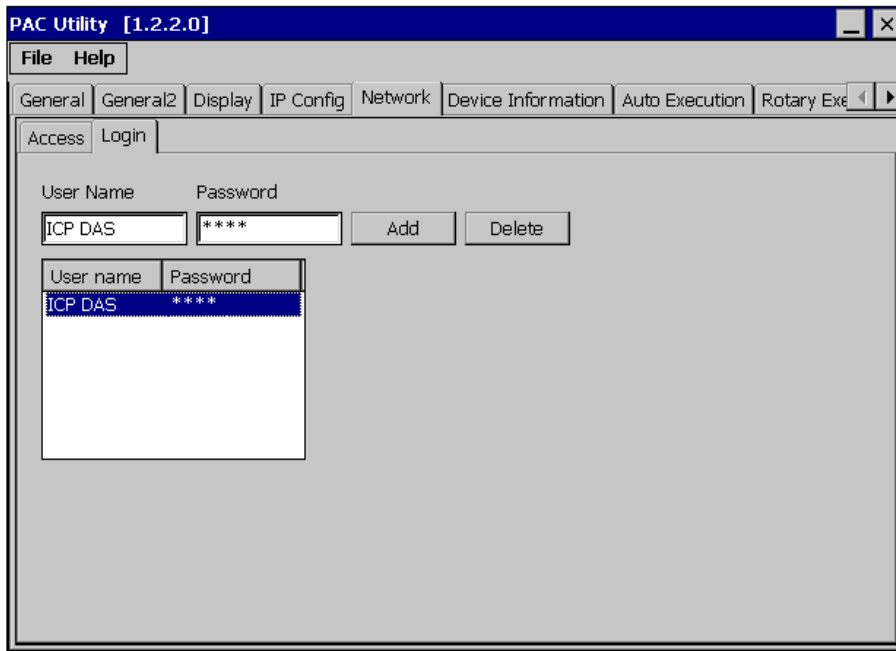

Step 4: On the File menu, click Save and Reboot for changes to take effect

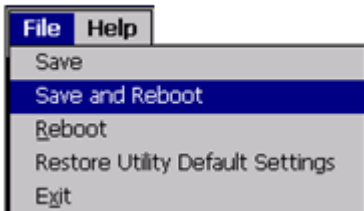

A.3.2. How to Use Telnet to remote login the WinPAC from PC

Here are step by step instructions on how to use telnet to remote login the WinPAC from PC.

Step 1: On the PC, open a MS-DOS command prompt

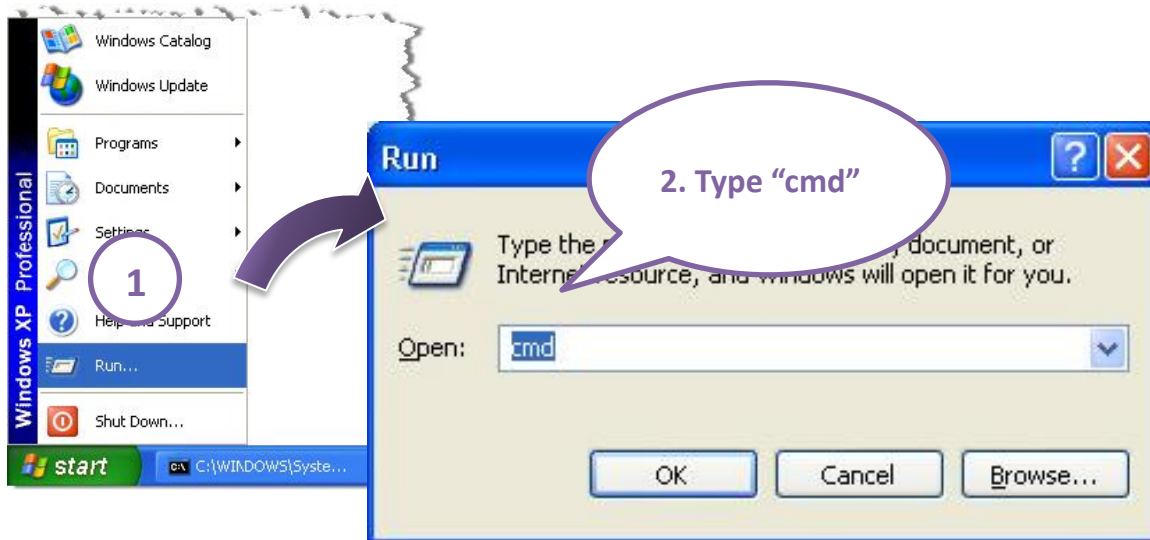

Step 2: At the command prompt, type "telnet (IP address)"

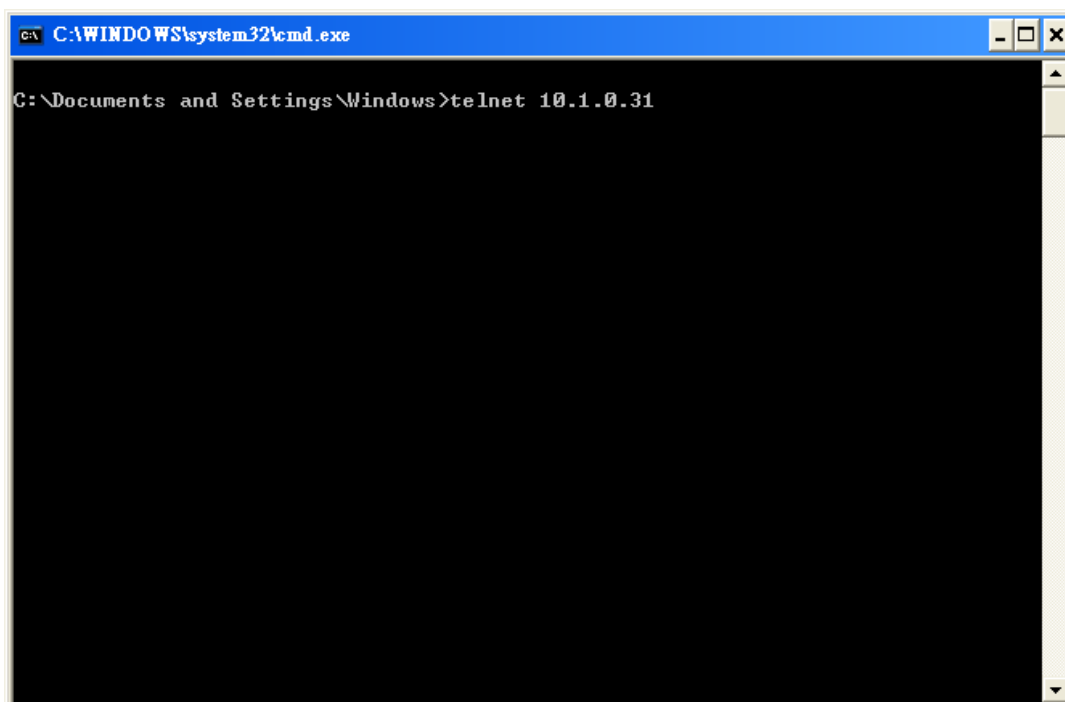

Step 3: The connection has been set up, and then type the name and password

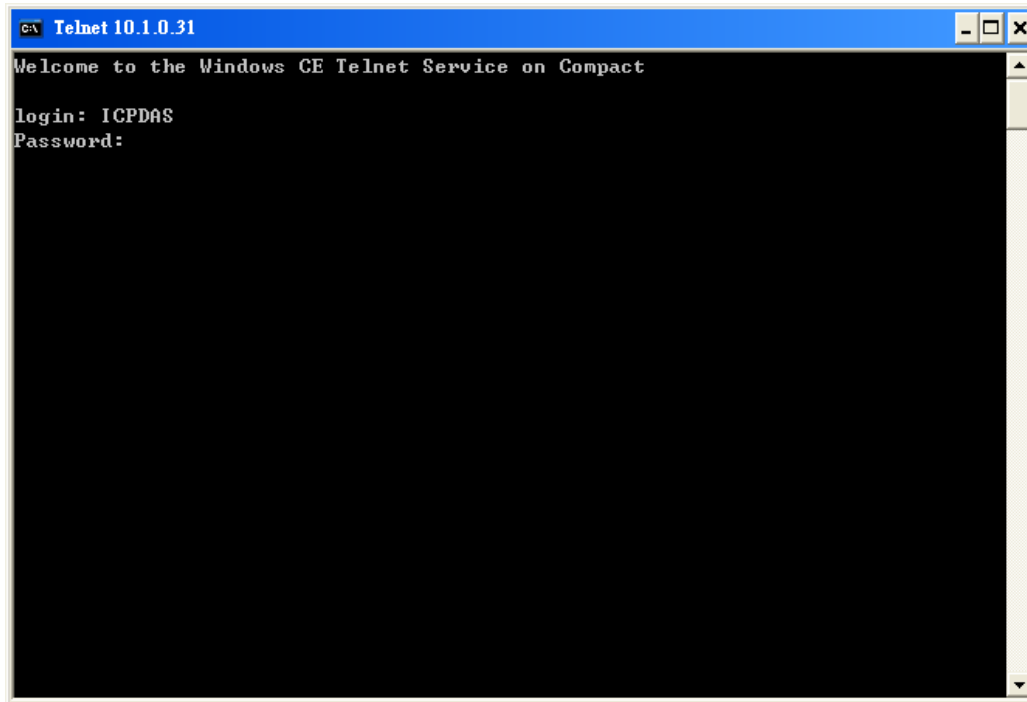

Step 4: The remote login has been completed

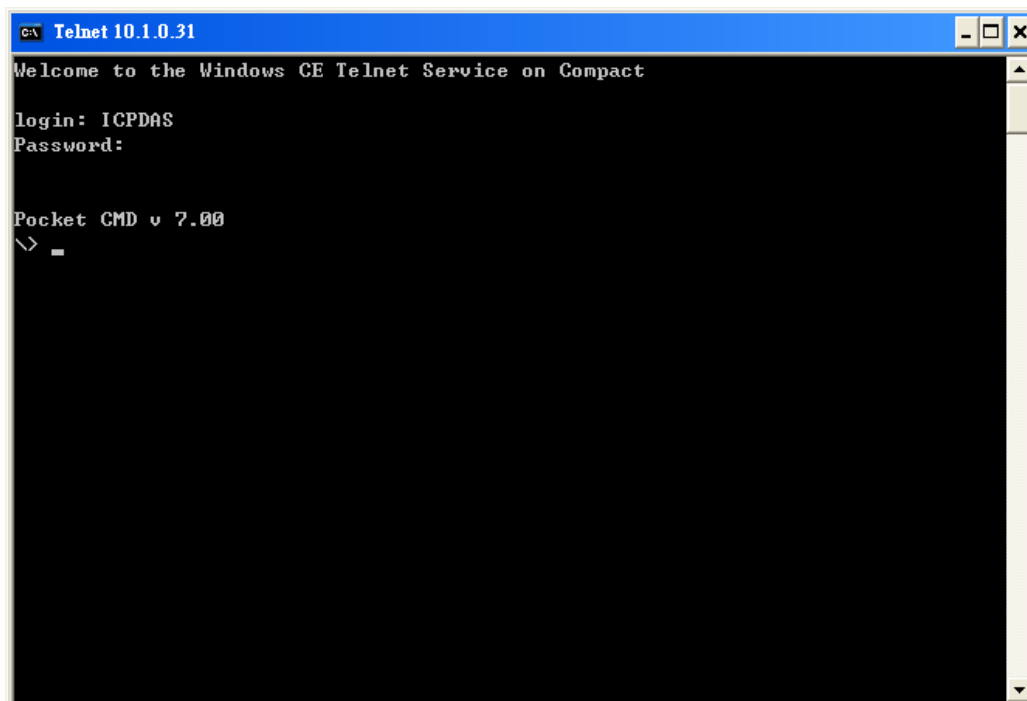

A.3.3. How to Remove a User Account from the Login List

Here are step by step instructions on how to remote the user from the login list.

Step 1: Click a user from the list which you want to remove, and the user will display in the field, and then press Delete to delete the user from the login list

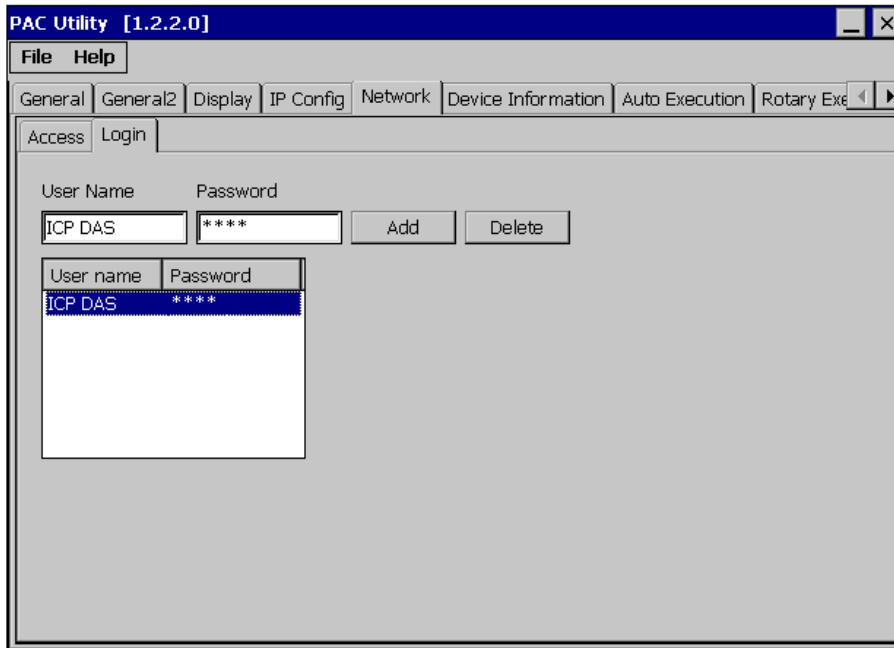

Step 2: On the File menu, click Save and Reboot for changes to take effect

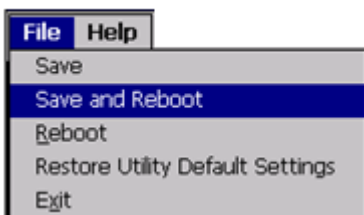

A.4. How to change the battery

RTC is retained by a Li-ion battery, which can supply continuous power for 10 years. The battery design has the added function of preventing data from being lost while replacing the battery. The following figures show the location of the battery installed in the WinPAC CPU board.

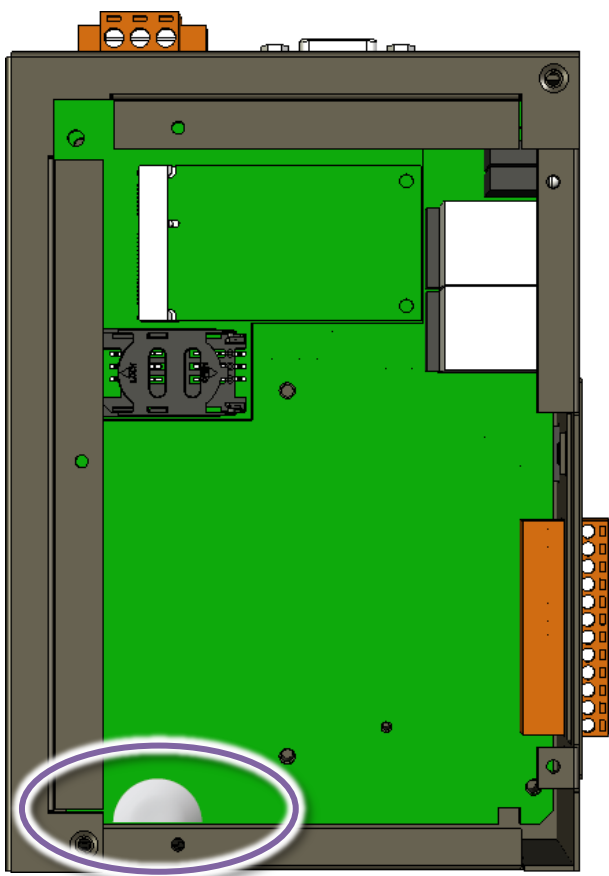

Checking the current battery power

1. Run the PAC utility and check the Battery 1 fields that display the current status. Refer to Section 3.1 PAC utility “General” for more details. If the power level is low that the battery should be replaced.
2. When programming this, call the `pac_GetBatteryLevel()` API function in the PACSDK.dll to check whether the battery power is low. When the power of the battery is low, it’s recommended that the battery is replaced immediately, otherwise the RTC time will be reset.

Replacing the battery

1. Power off the WinPAC device.
2. Remove the CPU board.
3. Remove the battery that is running low on power from the battery holder in CPU board.
4. Insert a new battery.
5. Set the RTC time.

Ordering information

Battery type: BR1632 (Part number is 2LB010 for ICP DAS)

For more detailed information, contact your local sales office or distributor.

A.5. How to Using the Practical Functions of the 3G/4G I/O Module

The Mobile network module of WinPAC series (Except for WP-2241M-CE7) that use the 3G/4G network to implement SMS and GPRS connection to send and receive functions.

A.5.1. How to Auto Dial 3G/4G GPRS network and redial when the network disconnected

The AutoDialer allows user to automatically dial GRPS network after boot.

When the GRPS network disconnect the AutoDialer will automatically re-dial Internet access.

Tips & Warnings



Before installing the SIM card, please cancel the PIN lock function of SIM card; otherwise you will not be able to dial the Internet

The demos can be found by downloading the latest version from ICP DAS web site.

http://ftp.icpdas.com/pub/cd/winpac_am335x/wp-2241/demo/3g_modem/autodialer/

The description of the demo can be found by downloading the latest version from ICP DAS web site.

http://ftp.icpdas.com/pub/cd/winpac_am335x/wp-2241/document/faq/development/

W5-13_How_to_use_Auto_dial_GPRS_network_and_redial_when_the_network_disconnected_en

A.5.2. How to Use the SMS Function and Get the GPS Data

The 3G/4G modem allows the user to use the SMS function and get the GPS data.

The API manual can be found by downloading the latest version from ICP DAS web site.

http://ftp.icpdas.com/pub/cd/winpac_am335x/wp-2241/demo/3g_modem/3g_modem_sms_demo/gsm_lib_manual_v1.0.1.pdf

The demos can be found by downloading the latest version from ICP DAS web site.

http://ftp.icpdas.com/pub/cd/winpac_am335x/wp-2241/demo/3g_modem/3g_modem_sms_demo

The description of the demo can be found by downloading the latest version from ICP DAS web site.

http://ftp.icpdas.com/pub/cd/winpac_am335x/wp-2241/document/faq/development/

W5-14_How_to_use_the_SMS_function_and_get_the_GPS_data_en

A.5.3. How to Synchronize the System Time by GPS Data

The demos can be found by downloading the latest version from ICP DAS web site.

http://ftp.icpdas.com/pub/cd/winpac_am335x/wp-2241/demo/3g_modem/gpstimesynchronization

The description of the demo can be found by downloading the latest version from ICP DAS web site.

http://ftp.icpdas.com/pub/cd/winpac_am335x/wp-2241/document/fag/development/

W5-15_How_to_Synchronize_the_system_time_by_GPS_data_en

Appendix. B. XV-Board Modules

The XV-board series are for LP-2241M, WP-2241M-CE7. One PAC can only plug only one XV-board. The XV-board series have following common specification:

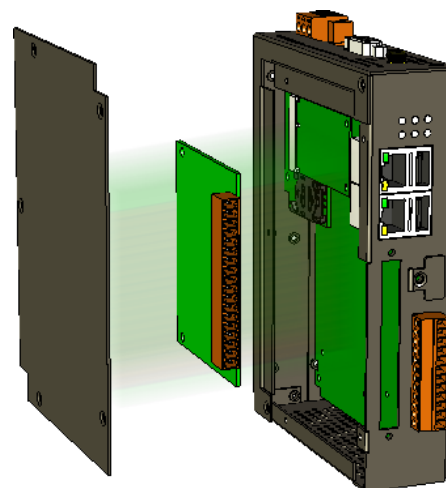

- DI channel is dry contact, sink type.
- DO channel is open collector, sink type.

DIO Expansion

Model	DI			DO	
	Channel	Type	Sink/Source	Channel	Sink/Source
XV107	8	Wet	Source	8	Sink
XV107A			Sink		Source
XV110	16	Dry/Wet	Sink/Source	-	-
XV111	-			16	Sink
XV111A					Source

Relay Output Expansion

Model	DI			Relay Output	
	Channel	Type	Sink/Source	Channel	Type
XV116	5	Wet	Sink/Source	2	Signal Relay
				4	Power Relay

Multi-Function Expansion

Model	AI	AO	DI			DO	
	Channel		Type	Sink/Source	Channel	Sink/Source	
XV308	8	-	Dry/Wet	Source	DI+DO=8	Sink	
XV310	4	5		Sink		Source	

For more detailed information about these support modules, please refer to

http://www.icpdas.com/root/product/solutions/hmi_touch_monitor/touchpad/xv-board_selection.html

Appendix. C. Revision History

This chapter provides revision history information to this document.

The table below shows the revision history.

Revision	Date	Description
1.0.1	December 2018	Initial issue