

---

# Contents of Appendix

---

<b>APPENDIX A : FUNCTIONS &amp; FUNCTION BLOCKS FOR ICP DAS PACS .....</b>	<b>A-1</b>
APPENDIX A.1: STANDARD ISAGRAF FUNCTION BLOCKS .....	A-1
APPENDIX A.2: ADDING NEW FUNCTION BLOCKS TO ISAGRAF.....	A-2
APPENDIX A.3: 7-SEGMENT LED REFERENCE TABLE .....	A-4
APPENDIX A.4: FUNCTION BLOCKS FOR THE CONTROLLER.....	A-5
<i>A4_20_TO</i> .....	A-5
<i>ANA</i> .....	A-6
<i>ARCREATE</i> .....	A-7
<i>ARRAY_R</i> .....	A-8
<i>ARRAY_W</i> .....	A-9
<i>ARREAD</i> .....	A-10
<i>ARWRITE</i> .....	A-10
<i>ARY_F_R</i> .....	A-11
<i>ARY_F_W</i> .....	A-11
<i>ARY_N_R</i> .....	A-12
<i>ARY_N_W</i> .....	A-12
<i>ARY_W_R</i> .....	A-13
<i>ARY_W_W</i> .....	A-13
<i>BCD_V</i> .....	A-14
<i>BIN2ENG</i> .....	A-14
<i>BIT_WD</i> .....	A-15
<i>BLINK</i> .....	A-15
<i>BOO</i> .....	A-17
<i>CJC</i> .....	A-18
<i>CJC_STS</i> .....	A-19
<i>CJC2</i> .....	A-20
<i>COM_STS</i> .....	A-21
<i>COMARY_R</i> .....	A-22
<i>COMARY_W</i> .....	A-22
<i>COMAY_NW</i> .....	A-23
<i>COMAY_WW</i> .....	A-24
<i>COMCLEAR</i> .....	A-25
<i>COMCLOSE</i> .....	A-25
<i>COMOPEN</i> .....	A-26
<i>COMOPEN2</i> .....	A-27
<i>COMREAD</i> .....	A-28
<i>COMREADY</i> .....	A-29
<i>COMSTR_W</i> .....	A-30
<i>COMWRITE</i> .....	A-31
<i>CRC_16</i> .....	A-32
<i>DI_CNT</i> .....	A-33
<i>DT2MESAG</i> .....	A-33
<i>EBUS_B_R</i> .....	A-34
<i>EBUS_B_W</i> .....	A-34
<i>EBUS_F_R</i> .....	A-35
<i>EBUS_F_W</i> .....	A-35
<i>EBUS_N_R</i> .....	A-36
<i>EBUS_N_W</i> .....	A-36
<i>EBUS_STS</i> .....	A-36
<i>EEP_B_R</i> .....	A-37
<i>EEP_B_W</i> .....	A-37
<i>EEP_BY_R</i> .....	A-38
<i>EEP_BY_W</i> .....	A-38

<i>EEP_EN</i> .....	A-38
<i>EEP_F_R</i> .....	A-39
<i>EEP_F_W</i> .....	A-40
<i>EEP_N_R</i> .....	A-41
<i>EEP_N_W</i> .....	A-42
<i>EEP_PR</i> .....	A-42
<i>EEP_WD_R</i> .....	A-43
<i>EEP_WD_W</i> .....	A-43
<i>F_APPEND</i> .....	A-44
<i>F_CLOSE</i> .....	A-44
<i>F_COPY</i> .....	A-45
<i>F_CREAT</i> .....	A-45
<i>F_DELETE</i> .....	A-46
<i>F_DIR</i> .....	A-46
<i>F_END</i> .....	A-46
<i>F_EOF</i> .....	A-47
<i>F_EXIST</i> .....	A-47
<i>F_READ_B</i> .....	A-48
<i>F_READ_F</i> .....	A-48
<i>F_READ_W</i> .....	A-49
<i>F_ROPEN</i> .....	A-49
<i>F_SEEK</i> .....	A-50
<i>F_TRIG</i> .....	A-50
<i>F_WOPEN</i> .....	A-51
<i>F_WRIT_B</i> .....	A-52
<i>F_WRIT_F</i> .....	A-52
<i>F_WRIT_S</i> .....	A-53
<i>F_WRIT_W</i> .....	A-53
<i>FA_READ</i> .....	A-54
<i>FA_WRITE</i> .....	A-55
<i>FBUS_B_R</i> .....	A-56
<i>FBUS_B_W</i> .....	A-56
<i>FBUS_F_R</i> .....	A-57
<i>FBUS_F_W</i> .....	A-57
<i>FBUS_N_R</i> .....	A-58
<i>FBUS_N_W</i> .....	A-58
<i>FBUS_STS</i> .....	A-58
<i>FM_READ</i> .....	A-59
<i>FM_WRITE</i> .....	A-60
<i>FR_B</i> .....	A-61
<i>Fr_B_A</i> .....	A-62
<i>GET_INFO</i> .....	A-63
<i>GET_SN</i> .....	A-63
<i>GET_VER</i> .....	A-64
<i>GETCTS</i> .....	A-64
<i>I_DICNT</i> .....	A-65
<i>I_DICNT2</i> .....	A-66
<i>I_RESET</i> .....	A-67
<i>I7000_EN</i> .....	A-67
<i>I8KE_B</i> .....	A-68
<i>I8KE_B_A</i> .....	A-69
<i>I8KE_F</i> .....	A-70
<i>I8KE_F_A</i> .....	A-71
<i>I8KE_N</i> .....	A-72
<i>I8KE_N_A</i> .....	A-73
<i>INP10LED</i> .....	A-74
<i>INP16LED</i> .....	A-75
<i>INT_REAL</i> .....	A-76

<i>INT_STR3</i> .....	A-76
<i>LONG_WD</i> .....	A-76
<i>MAIL_SET</i> .....	A-77
<i>MAIL_SND</i> .....	A-77
<i>MBUS_B_R</i> .....	A-77
<i>MBUS_B_W</i> .....	A-78
<i>MBUS_BRI</i> .....	A-79
<i>MBUS_N_R</i> .....	A-80
<i>MBUS_N_W</i> .....	A-81
<i>MBUS_NRI</i> .....	A-82
<i>MBUS_R</i> .....	A-83
<i>MBUS_RI</i> .....	A-84
<i>MBUS_WB</i> .....	A-85
<i>MI_BOO</i> .....	A-86
<i>MI_INP_N</i> .....	A-86
<i>MI_INP_S</i> .....	A-87
<i>MI_INT</i> .....	A-87
<i>MI_REAL</i> .....	A-88
<i>MI_STR</i> .....	A-88
<i>MSG_F</i> .....	A-89
<i>MSG_N</i> .....	A-90
<i>MSGARY_R</i> .....	A-91
<i>MSGARY_W</i> .....	A-91
<i>PID_AL</i> .....	A-92
<i>PLC_mode</i> .....	A-94
<i>PWM_DIS</i> .....	A-95
<i>PWM_EN</i> .....	A-95
<i>PWM_EN2</i> .....	A-95
<i>PWM_OFF</i> .....	A-95
<i>PWM_ON</i> .....	A-95
<i>PWM_SET</i> .....	A-95
<i>PWM_STS</i> .....	A-95
<i>PWM_STS2</i> .....	A-95
<i>R_MB_ADR</i> .....	A-96
<i>R_MB_REL</i> .....	A-96
<i>R_TRIG</i> .....	A-97
<i>RDN_A</i> .....	A-98
<i>RDN_B</i> .....	A-98
<i>RDN_F</i> .....	A-98
<i>RDN_N</i> .....	A-98
<i>RDN_T</i> .....	A-98
<i>REAL</i> .....	A-99
<i>REA_STR2</i> .....	A-100
<i>REAL_INT</i> .....	A-100
<i>REAL_STR</i> .....	A-100
<i>RETAIN_A</i> .....	A-101
<i>RETAIN_B</i> .....	A-102
<i>RETAIN_F</i> .....	A-103
<i>RETAIN_N</i> .....	A-104
<i>RETAIN_T</i> .....	A-105
<i>RETAIN_X</i> .....	A-106
<i>S_B_R</i> .....	A-107
<i>S_B_W</i> .....	A-107
<i>S_BY_R</i> .....	A-108
<i>S_BY_W</i> .....	A-108
<i>S_DL_DIS</i> .....	A-109
<i>S_DL_EN</i> .....	A-109
<i>S_DL_RST</i> .....	A-109

<i>S_DL_STS</i> .....	A-109
<i>S_FL_AVL</i> .....	A-110
<i>S_FL_INI</i> .....	A-111
<i>S_FL_RST</i> .....	A-111
<i>S_FL_STS</i> .....	A-112
<i>S_M_R</i> .....	A-113
<i>S_M_W</i> .....	A-113
<i>S_MB_ADR</i> .....	A-114
<i>S_MV</i> .....	A-115
<i>S_N_R</i> .....	A-116
<i>S_N_W</i> .....	A-116
<i>S_R_R</i> .....	A-117
<i>S_R_W</i> .....	A-117
<i>S_WD_R</i> .....	A-118
<i>SET_LED</i> .....	A-119
<i>SETRTS</i> .....	A-120
<i>SMS_GET</i> .....	A-120
<i>SMS_GETS</i> .....	A-120
<i>SMS_SEND</i> .....	A-121
<i>SMS_STS</i> .....	A-121
<i>SMS_TEST</i> .....	A-122
<i>STR_REAL</i> .....	A-122
<i>SYSDAT_R</i> .....	A-123
<i>SYSDAT_W</i> .....	A-124
<i>SYSTM_R</i> .....	A-125
<i>SYSTM_W</i> .....	A-126
<i>TCP_RECV</i> .....	A-127
<i>TCP_SEND</i> .....	A-127
<i>TIME_STR</i> .....	A-128
<i>TMR</i> .....	A-128
<i>TO_A4_20</i> .....	A-129
<i>TO_V0_10</i> .....	A-130
<i>TOF</i> .....	A-131
<i>TON</i> .....	A-132
<i>TP</i> .....	A-133
<i>TWIN_LED</i> .....	A-133
<i>UDP_RECV</i> .....	A-134
<i>UDP_SEND</i> .....	A-134
<i>V_BCD</i> .....	A-135
<i>V0_10_TO</i> .....	A-135
<i>VAL_HEX</i> .....	A-136
<i>VAL10LED</i> .....	A-137
<i>VAL16LED</i> .....	A-138
<i>W_MB_ADR</i> .....	A-139
<i>W_MB_REL</i> .....	A-139
<i>WD_BIT</i> .....	A-140
<i>WD_LONG</i> .....	A-140

**APPENDIX B : SETTING THE IP, MASK & GATEWAY IN THE I-8X37/IP-8X47, I-7188EG & µPAC-7186EG  
B-1**

**APPENDIX C : UPDATE THE I-8417/8817/8437/8837 CONTROLLER TO NEW HARDWARE DRIVER ...C-1**

APPENDIX C.1: SETTING I-8xx7 & I-7188EG's COM1 AS NONE-MODBUS-SLAVE PORT ..... C-4

**APPENDIX D : TABLE OF THE ANALOG IO VALUE.....D-1**

I-87013, I-7013, I-7033, I-7015, M-7015, M-7033, I-87015 .....D-1

I-8017H(8-CH), I-8017HS(16-CH).....D-4

I-87017, I-87017R, I-7017, I-7017R, M-7017, M-7017R .....D-5

I-7017RC, M-7017RC, I-87017RC.....	D-6
I-87018Z, I-87018R, I-87018, I-87019R, I-7018Z, I-7018R, I-7018, M-7018, M-7018R, I-7019R, M-7019R (1) ..	D-7
I-87018Z, I-87018R, I-87018, I-87019R, I-7018Z, I-7018R, I-7018, M-7018, M-7018R, I-7019R, M-7019R (2) ..	D-8
I-7021 .....	D-10
I-7022 .....	D-10
I-7005, M-7005, I-87005.....	D-11
I-8024 .....	D-13
I-87024, I-7024 .....	D-13
I-87022, I-87026 .....	D-14

**APPENDIX E : LANGUAGE REFERENCE.....E-1**

E.1 PROJECT ARCHITECTURE .....	E-3
<i>E.1.1 Programs</i> .....	E-3
<i>E.1.2 Cyclic and sequential operations</i> .....	E-3
<i>E.1.3 Child SFC and FC programs</i> .....	E-4
<i>E.1.4 Functions and sub-programs</i> .....	E-4
<i>E.1.5 Function blocks</i> .....	E-5
<i>E.1.6 Description language</i> .....	E-6
<i>E.1.7 Execution rules</i> .....	E-7
E.2 COMMON OBJECTS .....	E-8
<i>E.2.1 Basic types</i> .....	E-8
<i>E.2.2 Constant expressions</i> .....	E-8
<i>E.2.3 Variables</i> .....	E-10
<i>E.2.4 Comments</i> .....	E-13
<i>E.2.5 Defined words</i> .....	E-14
E.3 SFC LANGUAGE .....	E-16
<i>E.3.1 SFC chart main format</i> .....	E-16
<i>E.3.2 SFC basic components</i> .....	E-16
<i>E.3.3 Divergences and convergences</i> .....	E-18
<i>E.3.4 Macro steps</i> .....	E-20
<i>E.3.5 Actions within the steps</i> .....	E-21
<i>E.3.6 Conditions attached to transitions</i> .....	E-27
<i>E.3.7 SFC dynamic rules</i> .....	E-28
<i>E.3.8 SFC program hierarchy</i> .....	E-29
E.4 FLOW CHART LANGUAGE.....	E-31
<i>E.4.1 FC components</i> .....	E-31
<i>E.4.2 FC complex structures</i> .....	E-34
<i>E.4.3 FC dynamic behaviour</i> .....	E-34
<i>E.4.4 FC checking</i> .....	E-35
E.5 FBD LANGUAGE.....	E-36
<i>E.5.1 FBD diagram main format</i> .....	E-36
<i>E.5.2 RETURN statement</i> .....	E-37
<i>E.5.3 Jumps and labels</i> .....	E-37
<i>E.5.4 Boolean negation</i> .....	E-38
<i>E.5.5 Calling function or function blocks from the FBD</i> .....	E-38
E.6 LD LANGUAGE .....	E-40
<i>E.6.1 Power rails and connection lines</i> .....	E-40
<i>E.6.2 Multiple connection</i> .....	E-41
<i>E.6.3 Basic LD contacts and coils</i> .....	E-42
<i>E.6.4 RETURN statement</i> .....	E-48
<i>E.6.5 Jumps and labels</i> .....	E-48
<i>E.6.6 Blocks in LD</i> .....	E-49
E.7 ST LANGUAGE.....	E-51
<i>E.7.1 ST main syntax</i> .....	E-51
<i>E.7.2 Expression and parentheses</i> .....	E-51

<i>E.7.3 Function or function block calls</i> .....	<i>E-52</i>
<i>E.7.4 ST specific boolean operators</i> .....	<i>E-53</i>
<i>E.7.5 ST basic statements</i> .....	<i>E-55</i>
<i>E.7.6 ST extensions</i> .....	<i>E-62</i>
<b>E.8 IL LANGUAGE</b> .....	<b>E-67</b>
<i>E.8.1 IL main syntax</i> .....	<i>E-67</i>
<i>E.8.2 IL operators</i> .....	<i>E-68</i>
<b>APPENDIX F : HOW TO ENABLE/DISABLE W-8X47'S LAN2</b> .....	<b>F-1</b>

# Appendix A : Functions & Function Blocks For ICP DAS PACs

## Appendix A.1: Standard ISaGRAF Function Blocks

The following details the standard ISaGRAF function blocks that can be programmed with the I-8xx7, I-7188EG/XG, uPAC-7186EG & ISaGRAF WinCE PAC however labeled with “\*” & “#” is not supported by I-8xx7 & I-7188EG/XG, while ISaGRAF WinCE PAC doesn't support items with “#” label only.

-	*ARWRITE	*F_ROPEN	MSG	SHR
& (AND)	ASCII	F_TRIG	MUX4	SIG_GEN
*	ASIN	*F_WOPEN	MUX8	SIN
/	ATAN	*FA_READ	Neg	SQRT
+	AVERAGE	*FA_WRITE	NOT_MASK	SR
<	BLINK	FIND	ODD	STACKINT
<=	BOO	*FM_READ	#OPERATE	#SYSTEM
<>	CAT	*FM_WRITE	OR_MASK	TAN
=	CHAR	HYSTER	POW	TMR
=1 (XOR)	CMP	INSERT	R_TRIG	TOF
>	COS	INTEGRAL	RAND	TON
>=	CTD	LEFT	REAL	TP
>=1 (OR)	CTU	LIM_ALRM	REPLACE	TRUNC
1 gain	CTUD	LIMIT	RIGHT	XOR_MASK
ABS	#DAY_TIME	LOG	ROL	
ACOS	DELETE	MAX	ROR	
ANA	DERIVATE	MID	RS	
AND_MASK	EXPT	MIN	SEL	
*ARCREATE	*F_CLOSE	MLEN	SEMA	
*ARREAD	*F_EOF	MOD	SHL	

Please refer to the on-line help from the ISaGRAF workbench.

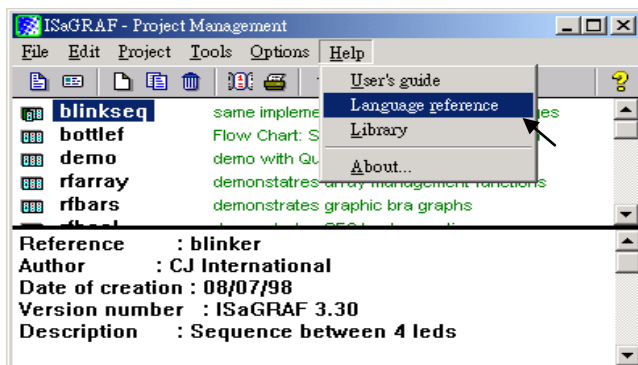

## Appendix A.2: Adding New Function Blocks To ISaGRAF

Click [Start]→[Program]→[ISaGRAF3.4] or [ISaGRAF3.4], then click on "Libraries" to begin installing or updating ISaGRAF functions or function blocks.

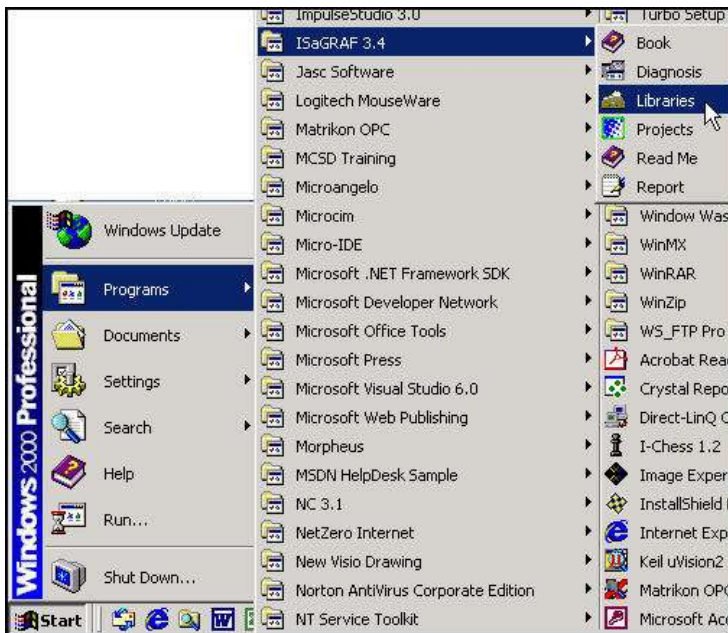

When you click on "Libraries" the "ISaGRAF Libraries" window will be open. To add a new function block or function select "Tools" from the menu bar and then click on "Archive".

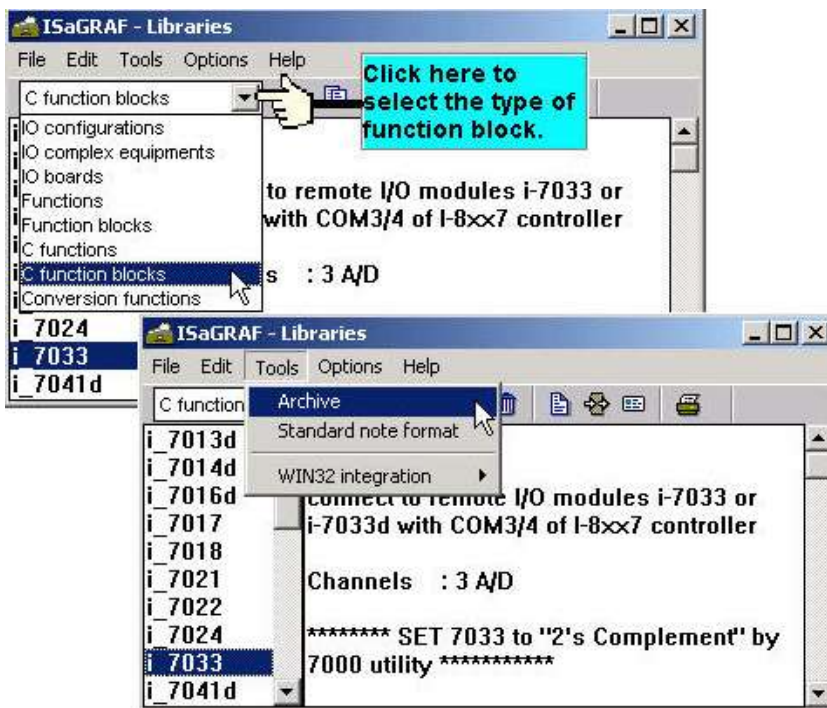

Click on the file name you want to "Archive" and then click "Browse" button to select the sub-directory where (CD\_ROM: \Napdos\ISaGRAF\ARK\ ) you want to archive the function block library to.



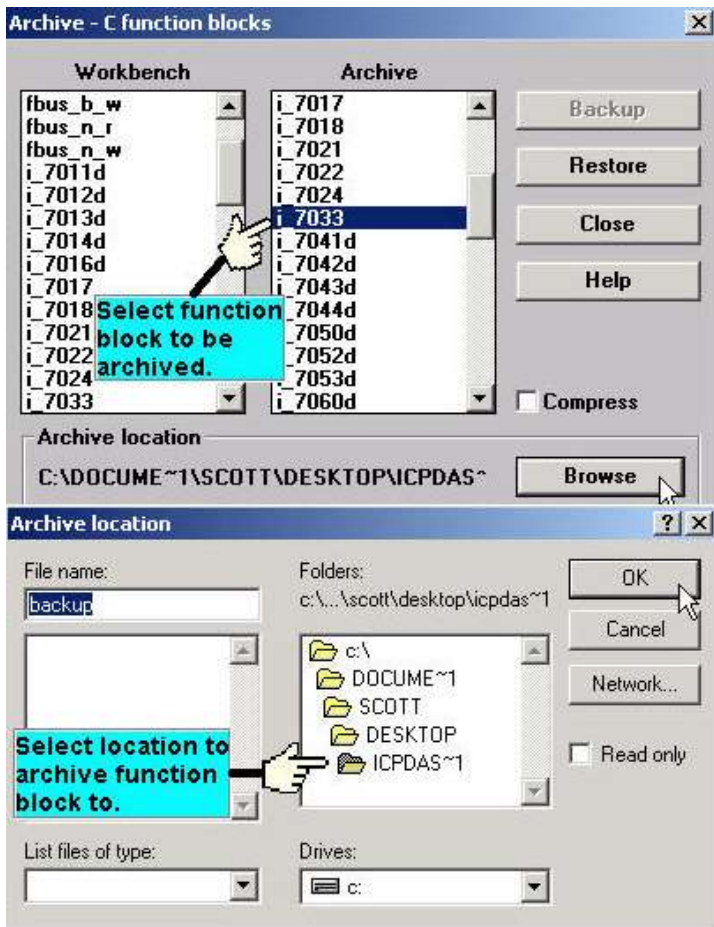

Select the new function block that you want to add from the "Archive" window, and then click on the "Restore" button. When you click on the "Restore" button the function block will be added to the ISaGRAF Workbench window.

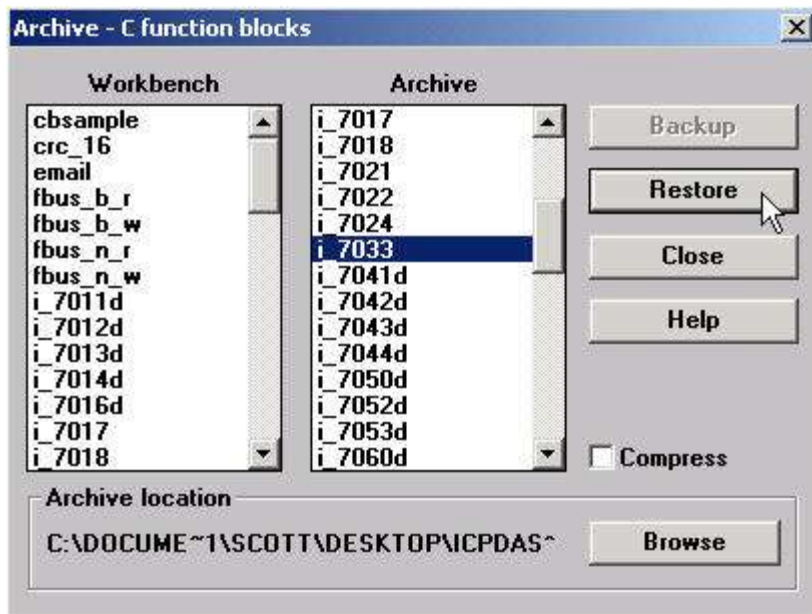

## Appendix A.3: 7-Segment LED Reference Table

The following table provides the reference definitions for programming the 7 LED indicators on the I-8xx7 & I-7188EGD/XGD PAC system.

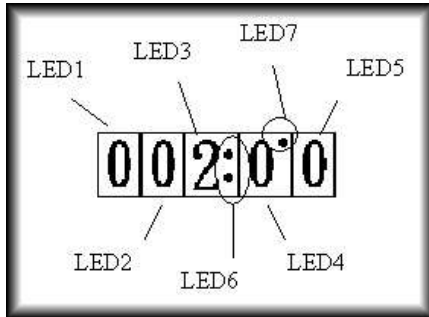

**LED 6:** Set to TRUE to display ":" (colon):

**LED 7:** Set to TRUE to display "." (period above LED 4)

**Display Table:** LED 1 through LED 5

Displayed Char.	Given Value	Displayed Char.	Given Value	Displayed Char.	Given Value
0	0	4.	20	r	40
1	1	5.	21	L	41
2	2	6.	22	n	42
3	3	7.	23	y	43
4	4	8.	24	U	44
5	5	9.	25	P	45
6	6	A.	26	o	46
7	7	b.	27	r.	47
8	8	C.	28	n.	48
9	9	d.	29	y.	49
A	10	E.	30	h.	50
b	11	F.	31	L.	51
C	12		32	U.	52
d	13		33	P.	53
E	14		34	o.	54
F	15		35	.	55
0.	16	H	36	.	56
1.	17	h	37	.	57
2.	18	H.	38	r	Others
3.	19	.	39		

# Appendix A.4: Function Blocks For The Controller

The following function blocks have been developed specifically for the I-8xx7, I-7188EG/XG, μPAC-7186EG & ISaGRAF WinCE PAC system. The Standard\_Function or Standard\_Function Block is supplied by ISaGRAF. The C\_Function or C\_Function Block is supplied by ICP DAS PAC Company.

## A4\_20\_TO

- I-8x17/iP-8x17   ■ I-8x37/iP-8x47   ■ I-7188EG/7186EG   ■ I-7188XG
- ISaGRAF WinCE PAC

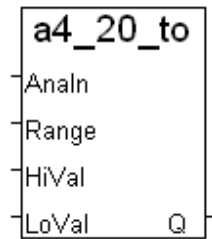

### Description: C\_Function

Convert Analog Input from 4 - 20 mA to User's Engineering Value ("Real" format)

#### Input Parameters:

- |               |         |  |
|---------------|---------|--|
| <b>Analn_</b> | Integer | the integer variable related to the Analog input board or module. The value is usually from -32768 to +32767 depending on the range setting of the IO board. |
| <b>Range_</b> | Integer | Range setting of the Analog input board or module.<br>16#6 : -20 to +20 mA,    16#7 : 4 to +20 mA<br>16#D : -20 to +20 mA,    16#1A : 0 to +20 mA,           |
| <b>HiVal_</b> | Real    | User's related High Eng. value when analog input signal is 20 mA   |
| <b>LoVal_</b> | Real    | User's related Low Eng. value when analog input signal is 4 mA.  |
- Ex:  
Convert I-8017H 's input signal from 4 - 20 mA to become 0 - 100 psi, please set HiVal\_ = 100.0 , LoVal\_ = 0.0 and Range\_ = 16#6 (depended on range setting of the related IO board)

#### Return:

- |           |      |   |
|-----------|------|---|
| <b>Q_</b> | Real | The Engineering value after conversion.<br>If given incorrect Range_ , returns 1.23E-20 |
|-----------|------|---|

#### Example:

Scale I-8017H 's current input with range setting as 6: (-20 to +20 mA) to user's engineering format of ( 0 to 100 psi). 4 mA means 0 psi , 20 mA means 100 psi

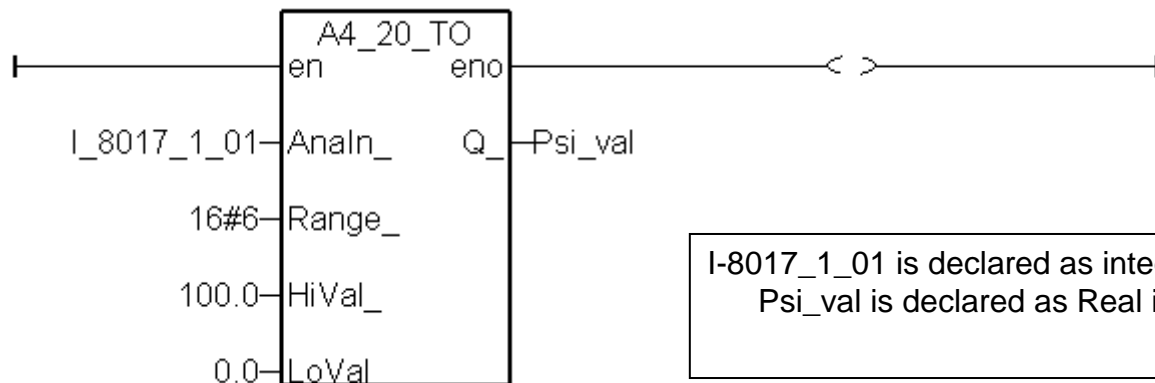

- Note:**
1. Please refer to similar functions: to\_A4\_20 , to\_V0\_10 , A4\_20\_to , V0\_10\_to
  2. When using A4\_20\_to, To\_A4\_20, To\_V0\_10, V0\_10\_to functions, user needs to upgrade the driver to the version listed below or latter version: i-7188EG: v2.16, i-7188XG: v2.14, i-8xx7:v3.18, so that the program can run well. (The older driver may cause the program cease after running a period of time.).

## ANA

- I-8x17/iP-8x17
- I-8x37/iP-8x47
- I-7188EG/7186EG
- I-7188XG
- ISaGRAF WinCE PAC

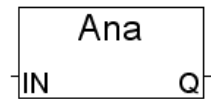

### Description : Standard\_Function

Convert any variable to an integer one

#### Input Parameters :

**IN** Any any non-integer analog value

#### Return :

**Q** Integer 0 if IN is FALSE / 1 if IN is TRUE  
Number of milliseconds for a timer  
Integer part for real analog  
Decimal number represented by a string

#### Example :

(\* FBD Example\*)

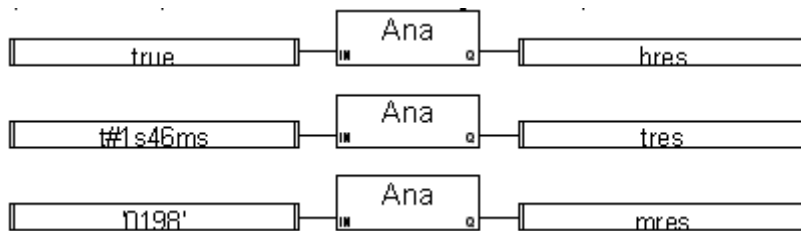

(\* ST equivalence : \*)

```
bres := ANA (true);          (* bres = 1 *)
tres := ANA (t#1s46ms);    (* tres = 1046 *)
mres := ANA ('0198');      (* mres = 198 *)
r1 := ANA (3.27);          (* r1 = 3 *)
```

(\* IL equivalence : \*)

```
LD      true
ANA
ST      bres
LD      t#1s46ms
ANA
ST      tres
LD      '0198'
ANA
ST      mres
```

## ARCREATE

- I-8x17/iP-8x17 □ I-8x37/iP-8x47 □ I-7188EG/7186EG □ I-7188XG
- ISaGRAF WinCE PAC

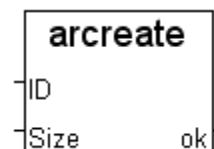

### Description : Standard\_Function

Creating a temporary Integer (Real) memory space for ISaGRAF program data storing

### Input Parameters :

<b>ID</b>	Integer	Set to 1 for ISaGRAF WinCE PAC, can not set as other number
<b>SIZE</b>	Integer	Could be (1 ~ 3,000,000) ISaGRAF WinCE PAC could set max. 3,000,000 of 32-bit Integer memory space. (Total are 3,000,000 x 4 = 12,000,000 bytes)

### Return :

<b>OK</b>	Integer	1: creation success; other: fail.
-----------	---------	-----------------------------------

### Note :

1. ISaGRAF WinCE PAC can use ARcreate only once in the program, see description below:  
Create this memory space in the first PLC Scan:

```
(* INIT initial as True, TMP_v type is Internal Integer *)  
IF INIT THEN  
    INIT := False;  
    TMP_v := ARcreate(1, 2000000);  
END_IF;
```

2. Please refer to Section: 11.3.10 for example & description.
3. If the PAC is W-8xx7/W-8xx6, the driver should be ver. 3.36 or later to support ARCREATE, ARREAD and ARWRITE function.

## ARRAY\_R

- I-8x17/iP-8x17 ■ I-8x37/iP-8x47 ■ I-7188EG/7186EG ■ I-7188XG
- ISaGRAF WinCE PAC

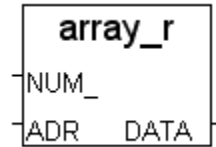

### Description : C\_Function

Read 1 byte from Byte Array (unsigned 8-bit)

### Input Parameters :

- NUM\_** Integer which array is read,  
I-8xx7 & I-7188EG/XG: (1 ~ 24) , ISaGRAF WinCE PAC: (1 ~ 48)
- ADR\_** Integer read which address in this array,  
I-8xx7 & I-7188EG/XG: (1 ~ 256), ISaGRAF WinCE PAC: (1 ~ 512)

### Return :

- DATA\_** Integer the read byte value (0~255)

### Example :

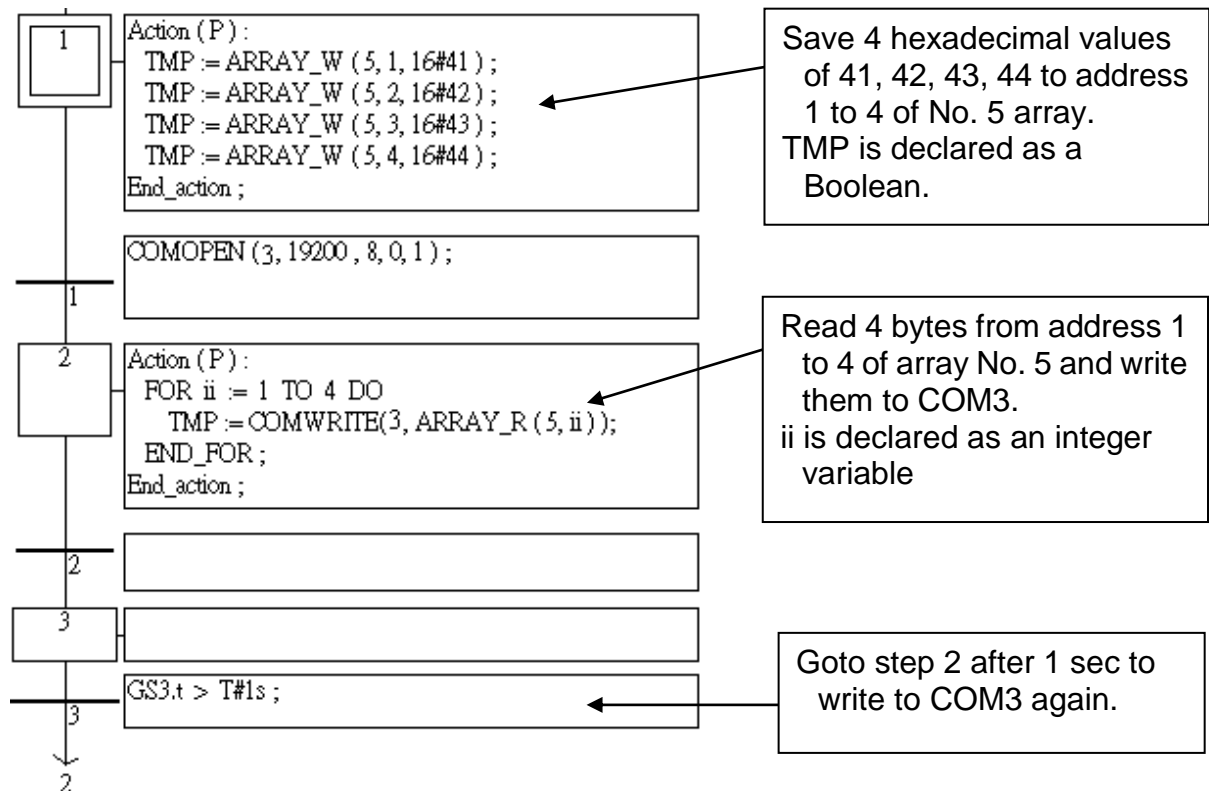

### Note:

The data stored in array are cleared after power off  
 For the W-8xx7: Recommend upgrade to ver. 3.36 or higher version

## ARRAY\_W

- I-8x17/iP-8x17 ■ I-8x37/iP-8x47 ■ I-7188EG/7186EG ■ I-7188XG
- ISaGRAF WinCE PAC

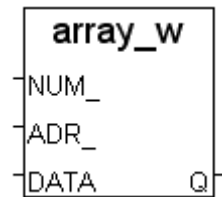

### Description : C\_Function

Save one byte to a byte array

### Input Parameters :

- |              |         |  |
|--------------|---------|--|
| <b>NUM_</b>  | Integer | Array ID to be operated, valid range values for:<br>I-8xx7 & I-7188EG/XG: (1 ~ 24); ISaGRAF WinCE PAC: (1 ~ 48).       |
| <b>ADR_</b>  | Integer | Address in the array where the byte is to be stored.<br>I-8xx7 & I-7188EG/XG: (1 ~ 256); ISaGRAF WinCE PAC: (1 ~ 512). |
| <b>DATA_</b> | Integer | The byte value to be saved to, valid range values from 0 to 255  |

### Return :

- |           |         |                                       |
|-----------|---------|---------------------------------------|
| <b>Q_</b> | Boolean | If OK, return TRUE; else return FALSE |
|-----------|---------|---------------------------------------|

**Example:** Please refer to the example of "ARRAY\_R".

### Note:

The data stored in array are cleared after power off.  
For the W-8xx7: Recommend upgrade to ver. 3.36 or higher version

## ARREAD

- I-8x17/iP-8x17 □ I-8x37/iP-8x47 □ I-7188EG/7186EG □ I-7188XG
- ISaGRAF WinCE PAC

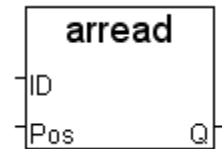

### Description : Standard\_Function

Read an Integer(32-bit signed) from user created temporary memory space

#### Input Parameters :

<b>ID</b>	Integer	Set to 1 for ISaGRAF WinCE PAC, can not set as other number.
<b>POS</b>	Integer	The position to be read, could be (1 ~ 3,000,000) If POS is larger than the number created by ARcreate, the return data will be wrong.

#### Return :

<b>Q</b>	Integer	The Integer has been read.
----------	---------	----------------------------

## ARWRITE

- I-8x17/iP-8x17 □ I-8x37/iP-8x47 □ I-7188EG/7186EG □ I-7188XG
- ISaGRAF WinCE PAC



### Description : Standard\_Function

Write an Integer to user created temporary memory space

#### Input Parameters :

<b>ID</b>	Integer	Set to 1 for ISaGRAF WinCE PAC, can not set as other number.
<b>POS</b>	Integer	The position want to write, could be (1 ~ 3,000,000) If POS is larger than the number created by ARcreate, data will not be written.
<b>IN</b>	Integer	The written Integer.

#### Return :

<b>OK</b>	Integer	1: success; other: fail.
-----------	---------	--------------------------

#### Note :

1. If user did not use ARcreate to create a memory space before using ARread & ARwrite, the return value will be wrong.
2. If user wants to read/write a Real value in the temporary memory space, please use Real\_Int & Int\_Real function to map between Integer & Real.  
(Please refer to the example of section 11.3.10 of the ISaGRAF User Manual)
3. If the PAC is W-8xx7/W-8xx6, the driver should be ver. 3.36 or later to support ARCREATE, ARREAD and ARWRITE function.



## ARY\_F\_R

- I-8x17/iP-8x17 ■ I-8x37/iP-8x47 ■ I-7188EG/7186EG ■ I-7188XG
- ISaGRAF WinCE PAC

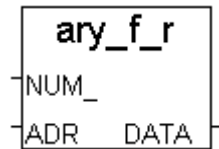

### Description : C\_Function

Read one float value (32-bit format) from an float array

#### Input Parameters :

- NUM\_ Integer** Array ID to be operated, valid range:  
For ISaGRAF WinCE PAC is from 1 to 18.  
For I-7188EG/XG & I-8xx7 is from 1 to 6.
- ADR\_ Integer** Address in the array where the Integer is to be stored, (1 ~ 256)

#### Return :

- DATA\_ Real** The returned Float value (32-bit float)

## ARY\_F\_W

- I-8x17/iP-8x17 ■ I-8x37/iP-8x47 ■ I-7188EG/7186EG ■ I-7188XG
- ISaGRAF WinCE PAC

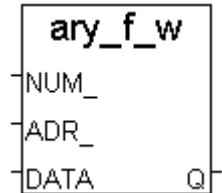

### Description : C\_Function

Save one float value (32-bit format) to a float array

#### Input Parameters :

- NUM\_ Integer** Array ID to be operated, valid range:  
For ISaGRAF WinCE PAC is from 1 to 18.  
For I-7188EG/XG & I-8xx7 is from 1 to 6.
- ADR\_ Integer** Address in the array where the integer is to be stored. (1 ~ 256)
- DATA\_ Real** The float value to be saved to (32-bit float)

#### Return :

- Q\_ Boolean** If OK, return TRUE, else return FALSE

#### Note:

1. The data stored in array are cleared after power off.
2. For I-7188EG/XG & I-8xx7, the float array and Integer array use the same memory.  
Please use them carefully. If use ARY\_F\_R to read the REAL value, but the value in the memory address is Integer data, the return value is not correct.
3. For using ARY\_F\_R and ARY\_F\_W, the driver must be the version listed below or higher version:
  - I-7188EG : since ver. 2.17
  - I-7188XG : since ver. 2.15
  - I-8xx7 : since ver. 3.19
  - W-8xx7 : Recommend upgrade to ver. 3.36 or higher version

## ARY\_N\_R

- I-8x17/iP-8x17 ■ I-8x37/iP-8x47 ■ I-7188EG/7186EG ■ I-7188XG
- ISaGRAF WinCE PAC

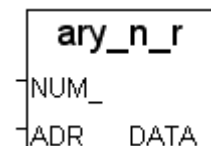

### Description : C\_Function

Read long integer (signed 32-bit) from Integer Array (signed 32-bit)

### Input Parameters :

- NUM\_** Integer Which array is read, valid range:  
I-8xx7 & I-7188EG/XG: (1 ~ 6); ISaGRAF WinCE PAC: (1 ~ 18);
- ADR\_** Integer Read which address in this array (1 ~ 256)

### Return :

- DATA\_** Integer The Integer been read

## ARY\_N\_W

- I-8x17/iP-8x17 ■ I-8x37/iP-8x47 ■ I-7188EG/7186EG ■ I-7188XG
- ISaGRAF WinCE PAC

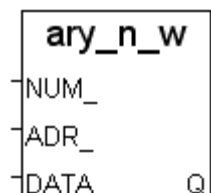

### Description : C\_Function

Write 1 long integer (signed 32-bit) to array

### Input Parameters :

- NUM\_** Integer Write to which array, valid range values:  
I-8xx7 & I-7188EG/XG: (1 ~ 6); ISaGRAF WinCE PAC: (1 ~ 18).
- ADR\_** Integer Write to which address in this array (1-256)
- DATA\_** Integer The Integer value to write

### Return :

- Q\_** Boolean True: ok; False: fail.

**Note:** 1. The Long Integer array use the same memory as short integer array. Be careful if using both of them at the same time.

Word Array(num,adr)	Integer Array(num,adr)
(1,1)	(1,1)
(1,2)	
(1,3)	(1,2)
(1,4)	
...	...
...	(6,256)
(12,255)	
(12,256)	...
...	
...	

2. The data stored in array are cleared after power off.

**Example:** Please refer to the example of "ARRAY\_R" .

## ARY\_W\_R

- I-8x17/iP-8x17 ■ I-8x37/iP-8x47 ■ I-7188EG/7186EG ■ I-7188XG
- ISaGRAF WinCE PAC

### Description : C\_Function

Read Short Integer (signed 16-bit) from array

### Input Parameters :

- NUM\_** Integer Which Short Integer array is read,  
I-8xx7 & I-7188EG/XG: (1 ~ 12);  
ISaGRAF WinCE PAC: (1 ~ 36).
- ADR\_** Integer Read which address in this array (1 ~ 256)

### Return :

- DATA\_** Integer The Short Integer been read (-32768 ~ +32767)

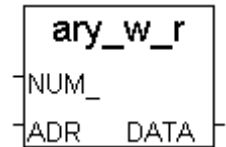

## ARY\_W\_W

- I-8x17/iP-8x17 ■ I-8x37/iP-8x47 ■ I-7188EG/7186EG ■ I-7188XG
- ISaGRAF WinCE PAC

### Description : C\_Function

Write 1 Short Integer (signed 16-bit) to array

### Input Parameters :

- NUM\_** Integer Write to which Short Integer array,  
I-8xx7 & I-7188EG/XG: (1 ~ 12);  
ISaGRAF WinCE PAC: (1 ~ 36).
- ADR\_** Integer Write to which address in this array (1-256).
- DATA\_** Integer The Short Integer value to write (-32768 ~ +32767)

### Return :

- Q\_** Boolean TRUE : ok; FALSE : fail.

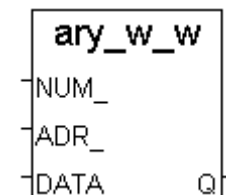

**Note:** 1. The Long Integer array use the same memory as the Short Integer array. Be careful if using both of them at the same time.

Word Array (num,adr)	Integer Array (num,adr)
(1,1)	(1,1)
(1,2)	
(1,3)	
(1,4)	
...	...
...	(6,256)
(12,255)	
(12,256)	...
...	
...	

2. The data stored in array are cleared after power off.

**Example:** Please refer to the example of "ARRAY\_R"

## BCD\_V

- I-8x17/iP-8x17 ■ I-8x37/iP-8x47 ■ I-7188EG/7186EG ■ I-7188XG
- ISaGRAF WinCE PAC

### Description : C\_Function

Convert BCD value to Decimal value

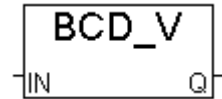

### Input Parameters :

**IN\_** Integer The BCD value

### Return :

**Q\_** Integer The decimal value, 0 ~ 99999999. EX:  
16#12345 → 12345  
18 → 12

## BIN2ENG

- I-8x17/iP-8x17 ■ I-8x37/iP-8x47 ■ I-7188EG/7186EG ■ I-7188XG
- ISaGRAF WinCE PAC

### Description : C\_Function

Convert 2's complement to Engineering format



### Input Parameters :

**IN\_** Integer The 2's complement to be converted

**HI\_2S\_** Integer Max. 2's complement value of In\_

**LO\_2S\_** Integer Min. 2's complement value of In\_

**HI\_EN\_** Integer Max. Engineering value of Out\_

**LO\_EN\_** Integer Min Engineering value of Out\_

### Return :

**OUT\_** Integer The converted Engineering format value

### EX:

HI\_2s\_ = 32767 , LO\_2s\_ = -32768, HI\_EN\_ = 1000, LO\_EN\_ = -1000

IN\_ = 16383 → OUT\_ = 500

IN\_ = -12345 → OUT\_ = -377

**Note:** HI\_2S\_ can not be the same value as LO\_2S\_, and both value must be wrote in the range of (-32768 ~ +32767).

## BIT\_WD

- I-8x17/iP-8x17 ■ I-8x37/iP-8x47 ■ I-7188EG/7186EG ■ I-7188XG
- ISaGRAF WinCE PAC

### Description : C\_Function

Convert 16 Boolean values to a Word value

#### Input Parameters :

**B1\_ ~ B16\_** Boolean The 16 Booleans to be converted

#### Return :

**VAL\_** Integer The converted Word value (-32768 ~ +32767)

EX: If B1\_ , B2\_ is TRUE , others is FALSE , the Word value is 3.  
If B1\_ , B8\_ is TRUE , others is FALSE , the Word value is 129.  
If all of B1\_ ~ B16 is TRUE , the Word value is -1.

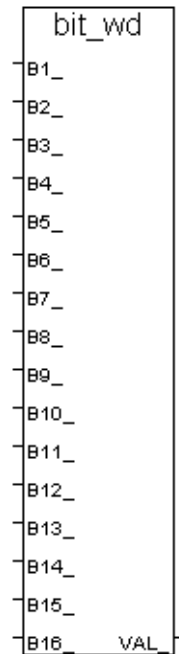

## BLINK

- I-8x17/iP-8x17 ■ I-8x37/iP-8x47 ■ I-7188EG/7186EG ■ I-7188XG
- ISaGRAF WinCE PAC

### Description : Standard\_Function Block

Generate an ON\_OFF blinking signal.

#### Input Parameters :

**RUN** Boolean Mode: TRUE = blinking / FALSE = reset the output to false  
**CYCLE** Timer Blinking period

#### Return :

**Q** Boolean Output ON\_OFF blinking signal



#### Timing diagram:

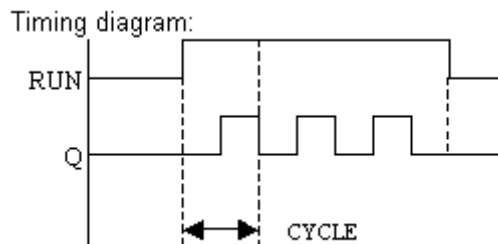

(Next page please)

**Note:**

BLINK Function Block could generate a Pulse True in a fixed interval. It could be used to some applications that need to do something every fixed period, such as:

(\* LD Program: \*)

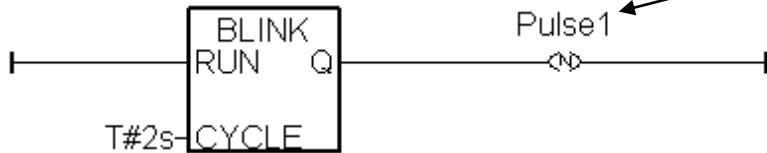

Pulse1 is declared as Boolean Internal. It will do something every 2s in this example.

(\* ST Program: \*)

```
IF Pulse1 THEN
  (* Do some thing *)
  (* ..... *)
END_IF;
```

If the time interval is smaller than 200ms or the PLC Scan Time becomes larger, the time precision will be low. For example, do something every 50ms. The 50ms is a smaller interval and the value is close to the PLC Scan Time. The result will become not so precise. User can change the program as below to improve the accuracy.

**ST Program:**

```
IF INIT THEN
  INIT := False;
  T1 := T#0s;
  T1_next := T1 + T#50ms;
  Tstart (T1);
END_IF;

IF T1 >= T1_next THEN
  IF T1 > T#22h THEN
    T1 := T#0s;
    T1_next := T#0s;
  END_IF;
  T1_next := T1_next + T#50ms;
  (*Do some thing *)
  (* ..... *)
END_IF;
```

INIT is declared as Boolean Internal Initial value is TRUE  
T1 & T1\_next is declared as Timer Internal.

## BOO

- I-8x17/iP-8x17
- I-8x37/iP-8x47
- I-7188EG/7186EG
- I-7188XG
- ISaGRAF WinCE PAC

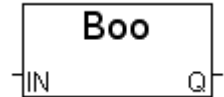

### Description : Standard\_Function

Convert any variable to a Boolean one

#### Input Parameters :

**IN** Any Any non-boolean value

#### Return :

**Q** Boolean TRUE for non-zero numerical value  
FALSE for zero numerical value  
TRUE for 'TRUE' message  
FALSE for 'FALSE' message

#### Example :

(\* FBD Example "Convert to Boolean" blocks \*)

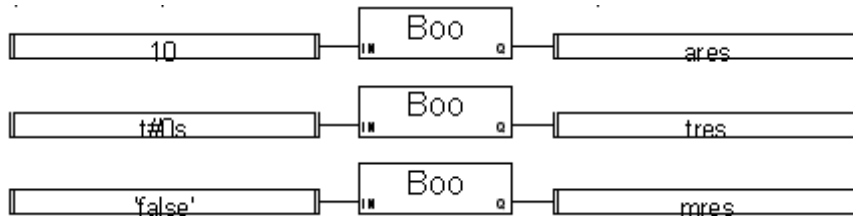

(\* ST Equivalence: \*)

```
ares := BOO (10);      (* ares is TRUE *)
tres := BOO (t#0s);   (* tres is FALSE *)
mres := BOO ('false'); (* mres is FALSE *)
```

(\* IL equivalence: \*)

```
LD    10
BOO
ST    ares
LD    t#0s
BOO
ST    tres
LD    'false'
BOO
ST    mres
```

## CJC

- I-8x17/iP-8x17 ■ I-8x37/iP-8x47 ■ I-7188EG/7186EG ■ I-7188XG
- ISaGRAF WinCE PAC

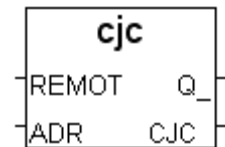

### Description : C\_Function Block

Read Cold-Junction Compensation (CJC) temperature of module I-7018 / 7019 & I-87018 / 87019

### Input Parameters :

**REMOTE\_** Boolean Must be a constant value, not a variable

If I-7018/7019 & I-87018/87019 are used as remote I/O,

REMOTE\_ is TRUE.

If I-87018/87019 is plugged in Main Control Unit,

REMOTE\_ is FALSE.

**ADR\_** Integer Must be a constant value, not a variable

If REMOTE\_ is TRUE, ADR\_ means the remote I/O module's address (1 ~ 255)

If REMOTE\_ is FALSE, ADR\_ means slot No., 0 ~ 7 (W-8xx7/8xx6 ADR\_ means slot No., 1 ~ 7)

### Return :

**Q\_** Boolean TRUE: work ok.

FALSE: communication is bad, the following return value has no meaning.

**CJC\_** Integer The Analog input value (2's complement format)

D3B4 ---> 0000 ---> 7FFF (hex.)

Val: -11340 ---> 0 ---> 32767 (dec.)

Temperature: -45 ---> 0 ---> +130 (degree Celsius)

### Note : (VERY IMPORTANT)

1. If I-87018 / 87019 is plugged in the Main Control Unit, please connect the 87018 / 87019 I/O board first, or the "CJC" function block will not work.
2. If I-7018 / 7019 and I-87018 / 87019 are used as RS-485 remote I/O, please use DCON utility to set format as 2's complement.
3. For the W-8xx7/8xx6 should use the driver version 3.21 or latter version.



## CJC\_STS

■ I-8x17/iP-8x17 ■ I-8x37/iP-8x47 ■ I-7188EG/7186EG ■ I-7188XG □ ISaGRAF WinCE PAC

### Description : C\_Function Block

Read/Write CJC compensation of the I-7018, I-7019, I-87018  
(CJC: Cold-Junction Compensation)

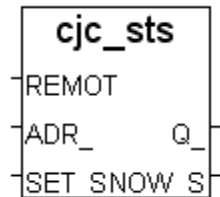

### Input Parameters :

- |                 |         |  |
|-----------------|---------|--|
| <b>REMOTE_</b>  | Boolean | Must be a constant value, not a variable<br>If I-7018/7019 and I-87018/87019 are used as remote I/O,<br>REMOTE_ is TRUE.<br>If I-87018/87019 is plugged in Main Control Unit,<br>REMOTE_ is FALSE. |
| <b>ADR_</b>     | Integer | Must be a constant value, not a variable<br>If REMOTE_ is TRUE,<br>ADR_ is the remote I/O module's address (1 ~ 255).<br>If REMOTE_ is FALSE,<br>ADR_ is the slot No., (0 ~ 7).                    |
| <b>SET_STS_</b> | Boolean | If SET_STS_ is FALSE, disable CJC compensation.<br>If SET_STS_ is TRUE, enable CJC compensation.   |

### Return :

- |                 |         |  |
|-----------------|---------|--|
| <b>Q_</b>       | Boolean | TRUE: work ok.<br>FALSE: communication is bad, the following return value has no meaning.              |
| <b>NOW_STS_</b> | Boolean | If NOW_STS_ is FALSE, disable CJC compensation now<br>If NOW_STS_ is TRUE, enable CJC compensation now |

### Note (VERY IMPORTANT):

1. If the I-87018/87019 is plugged in the Main Control Unit, please connect the 87018/ 87019 I/O board first, then "CJC" function block can work.
2. If the I-87018/87019 is used as a RS-485 Remote I/O, please operate the following steps before connecting them.
  - A. At I/O module side, please use "DCON Utility" to setup:
    - \*1. Set "address" to a unique No. (1~255)
    - \*2. Set proper "checksum disabled" or "checksum enabled" and set Analog Input module to be "2's complement".
    - \*3. Set communication parameter to "baud rate" and "8,N,1"
    - \*4. Set "Range Type" if using Analog board
  - B. At I-8xx7/I-7188EG/I-7188XG side:
    - \*1. Connect I/O complex equipment "bus7000B" and set its "baud rate" and "Checksum" equal to the "baud rate" & "Checksum" setting of the I/O modules.
    - \*2. I-8xx7 & 7188EG/XG can connect up to 64 remote I/O modules, W-8xx7 can up to 255.
    - \*3. Please use i\_7xxx function block or i\_87xxx Function Block when programming RS-485 Remote I/O module.

## CJC2

- I-8x17/iP-8x17 ■ I-8x37/iP-8x47 ■ I-7188EG/7186EG ■ I-7188XG
- ISaGRAF WinCE PAC

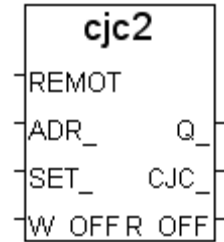

### Description : C\_Function Block

Read Cold-Junction Compensation (CJC) temperature of module I-7018/7019 & I-87018/87019 with Offset

### Input Parameters :

- |                  |         |   |
|------------------|---------|---|
| <b>REMOTE_</b>   | Boolean | Must be a constant value, not a variable.<br>If I-7018/7019 & I-87018/87019 are used as remote I/O, REMOTE_ is TRUE.<br>If I-87018/87019 is plugged in Main Control Unit, REMOTE_ is FALSE. |
| <b>ADR_</b>      | Integer | Must be a constant value, not a variable<br>If REMOTE_ is TRUE,<br>ADR_ is the remote I/O module's address (1 ~ 255).<br>If REMOTE_ is FALSE,<br>ADR_ is the slot No., (0 ~ 7).             |
| <b>SET_</b>      | Boolean | Start to set CJC temperature offset if TRUE   |
| <b>W_OFFSET_</b> | Integer | CJC temperature offset in decimal format, from -4096 to +4096, each count is 0.01 degree Celsius  |

### Return :

- |                 |         |   |
|-----------------|---------|---|
| <b>Q_</b>       | Boolean | TRUE: work ok.<br>FALSE: communication is bad, the following return value has no meaning.   |
| <b>CJC_</b>     | Integer | The Analog input value (2's complement format)<br>D3B4 ---> 0000 ---> 7FFF (hex.)<br>Val: -11340 ---> 0 ---> 32767 (dec.)<br>Temperature: -45 ---> 0 ---> +130 (degree Celsius) |
| <b>R_OFFSET</b> | Integer | Read CJC temperature offset   |

### Note (VERY IMPORTANT):

1. If the I-87018/87019 is plugged in the Main Control Unit, please connect the 87018/ 87019 I/O board first, then "CJC2" function block can work.
2. If the I-87018/87019 is used as a RS-485 Remote I/O, please operate the following steps before connecting them.
  - A. At I/O module side, please use "DCON Utility" to setup:
    - \*1. Set "address" to a unique No. (1~255)
    - \*2. Set proper "checksum disabled" or "checksum enabled" and set Analog Input module to be "2's complement".
    - \*3. Set communication parameter to "baud rate" and "8,N,1"
    - \*4. Set "Range Type" if using Analog board
  - B. At I-8xx7/I-7188EG/I-7188XG side:
    - \*1. Connect I/O complex equipment "bus7000B" and set its "baud rate" and "Checksum" equal to the "baud rate" & "Checksum" setting of the I/O modules.
    - \*2. I-8xx7 & 7188EG/XG can connect up to 64 remote I/O modules, W-8xx7 can up to 255.
    - \*3. Please use i\_7xxx function block or i\_87xxx Function Block when programming RS-485 Remote I/O module,

## COM\_STS

- I-8x17/iP-8x17 ■ I-8x37/iP-8x47 ■ I-7188EG/7186EG ■ I-7188XG
- ISaGRAF WinCE PAC

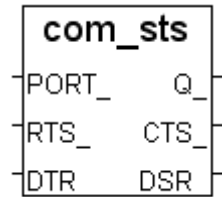

### Description : C\_Function Block

Set RTS, DTR and Get CTS, DSR of COM PORT

### Input Parameters :

<b>PORT_</b>	Integer	COM port. 3:COM3: 4:COM4; 5:COM5... I-8417/8817/8437/8837: Valid ComPort No.= 3, 4 & 5 I-7188XG & I-7188EG: Valid ComPort No.= 4
<b>RTS_</b>	Boolean	TRUE: set RTS active, FALSE: set RTS inactive
<b>DTR_</b>	Boolean	TRUE: set DTR active, FALSE: set DTR inactive

### Return :

<b>Q_</b>	Boolean	TRUE: Ok , FALSE: Fail
<b>CTS_</b>	Boolean	Get CTS status
<b>DSR_</b>	Boolean	Get DSR status

### Note :

1. Using Comopen( ) to open port.

## COMARY\_R

■ I-8x17/iP-8x17 ■ I-8x37/iP-8x47 ■ I-7188EG/7186EG ■ I-7188XG ■ ISaGRAF WinCE PAC

### Description : C\_Function

Read all bytes ready in the COM PORT buffer into a byte array  
(unsigned 8-bit)

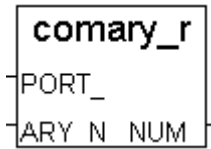

### Input Parameters :

**PORT\_** Integer Port number. I-8xx7:1, 3 ~ 20; I-7188EG:1~8; I-7188XG:2~8; W-8xx7:2, 3, or ...  
**ARY\_NO\_** Integer Byte array number (I-8xx7 & I-7188EG/XG:1~24; ISaGRAF WinCE PAC:1~48), to save bytes been read from COM

### Return :

**NUM\_** Integer The number of bytes been read from COM port (0~256)

**Note :** Serial communication data need time to transfer. When COMARY\_R is called, it will save the same number of bytes that have been received into the buffer at that time to the assigned array. The data are not received yet, of course are not saved into the array.

## COMARY\_W

■ I-8x17/iP-8x17 ■ I-8x37/iP-8x47 ■ I-7188EG/7186EG ■ I-7188XG  
■ ISaGRAF WinCE PAC

### Description : C\_Function

Write some bytes from one byte array to one COM PORT  
(unsigned 8-bit)

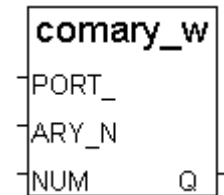

### Input Parameters :

**PORT\_** Integer Port number, I-8xx7:1, 3 ~ 20; I-7188EG:1~8; I-7188XG:2~8; W-8xx7:2, 3, or ...  
**ARY\_NO\_** Integer The byte array No. to write (I-8xx7 & I-7188EG/XG:1~24) , (ISaGRAF WinCE PAC:1~48)  
**NUM\_** Integer Number of bytes to write from the 1st unit of byte array (0~256)

### Return :

**Q\_** Boolean TRUE: ok

### Note:

- 1 Before using COM1 of I-8xx7 & I-7188EG, please set COM1 as a non-Modbus-RTU port (Please refer to Appendix C.1)
- 2 Before using COM2 or COM3 of W-8xx7, please set COM2/3 as a non-Modbus-RTU port (Please refer to "Getting started of W-8xx7")
- 3 I-8xx7:  
ComPort No. on slot 0: Com5 ~ Com8  
ComPort No. on slot 1: Com9 ~ Com12  
ComPort No. on slot 2: Com13 ~ Com16  
ComPort No. on slot 3: Com17 ~ Com20  
ComPort No. on slot 4 ~ 7 : not supported

### Example:

Please refer to Chapter 11 - Demo\_21, 22 & 23.  
Refer to Appendix A.4 : "ARRAY\_R" & "ARRAY\_W"

## COMAY\_NW

- I-8x17/iP-8x17 ■ I-8x37/iP-8x47 ■ I-7188EG/7186EG ■ I-7188XG
- ISaGRAF WinCE PAC

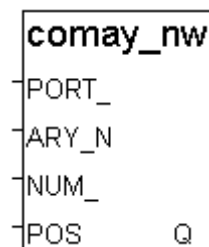

### Description : C\_Function

Write one Long Integer (signed 32 bit) array to COM PORT  
Each Long Integer is composed of 4 bytes, and the format is a signed Long.

Each Integer written is composed of 4 bytes in the below INTEL format.

[lowest byte] [ ] [ ] [highest byte]

For ex., if there are 3 Integers to write, the first one is 16#04030201 (67,305,985), the second one is 16#08070605 (134,678,021) and the last one is 16#FFFFFFFE (-2).

The 12 bytes been written will be [01] [02] [03] [04] [05] [06] [07] [08] [FE] [FF] [FF] [FF]

### Input Parameters :

- |                |         |  |
|----------------|---------|--|
| <b>PORT_</b>   | Integer | Port number, I-8xx7:1, 3 ~ 20; I-7188EG:1~8; I-7188XG:2~8; W-8xx7:2, 3, or ...   |
| <b>ARY_NO_</b> | Integer | The array No. to write (I-8xx7 & I-7188EG/XG:1~6) , (ISaGRAF WinCE PAC:1~18)   |
| <b>NUM_</b>    | Integer | Number of Integers to write (0~256)  |
| <b>POS_</b>    | Integer | Start position inside the array to write (1~256)<br>If POS_+NUM_ > 257, only (257~POS_) Long Integer will be written<br>Ex. If POS_=255, NUM_=3, only 2 integers written.<br>They are Pos. 255 & Pos. 256. |

### Return :

- |           |         |                                  |
|-----------|---------|----------------------------------|
| <b>Q_</b> | Boolean | TRUE means Ok, FALSE means fail. |
|-----------|---------|----------------------------------|

### Note :

1. If use COM1 of I-8xx7 & I-7188EG, please preset COM1 as a non-Modbus-RTU port. (Please refer to Appendix C.1)
2. If use COM2 or COM3 of W-8xx7, please preset them as non-Modbus-RTU ports. (Please refer to "The Getting started" of W-8xx7)
3. I-8xx7:
  - ComPort No. on slot 0: Com5 ~ Com8
  - ComPort No. on slot 1: Com9 ~ Com12
  - ComPort No. on slot 2: Com13 ~ Com16
  - ComPort No. on slot 3: Com17 ~ Com20
  - ComPort No. on slot 4 ~ 7 : do not support.
4. Integer array and word array use the same memory. Be careful if use both of them at the same time. (Refer to the description of Ary\_N\_W)

## COMAY\_WW

- I-8x17/iP-8x17 ■ I-8x37/iP-8x47 ■ I-7188EG/7186EG ■ I-7188XG
- ISaGRAF WinCE PAC

### Description : C\_Function

Write some Words (signed 16 bit) of a Word array to COM PORT

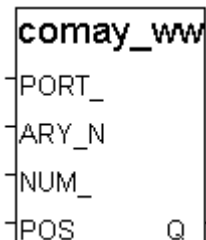

Each Word is composed of 2 bytes and as signed format (-32768 ~ +32767).

The word is wrote to COM PORT in the below INTEL format.

[low byte] [high byte]

Ex. if there is 3 words to write, the 1st one is 16#0403 (1,027),

the 2nd one is 16#0807 (2,055) and the last one is 16#FFFE (-2).

The 6 bytes been written will be [03] [04] [07] [08] [FE] [FF]

### Input Parameters :

<b>PORT_</b>	Integer	Port number, I-8xx7:1, 3 ~ 20; I-7188EG:1~8; I-7188XG:2~8; W-8xx7:2, 3, or ...
<b>ARY_NO_</b>	Integer	The word array No. to write (I-8xx7 & I-7188EG/XG:1~12); (ISaGRAF WinCE PAC:1~36)
<b>NUM_</b>	Integer	Number of Words to write
<b>POS_</b>	Integer	Start position inside the Word array to write (1~256) If POS_+NUM_ > 257, only (257~POS_) words will be written Ex: If POS_=255, NUM_=3, only 2 words will be written, They are Pos. 255 & Pos. 256.

### Return :

<b>Q_</b>	Boolean	TRUE: OK; False: fail.
-----------	---------	------------------------

### Note:

1. If use COM1 of I-8xx7 & I-7188EG, please preset COM1 as a non-Modbus-RTU port. (Please refer to Appendix C.1)
2. If use COM2 or COM3 of W-8xx7, please preset them as non-Modbus-RTU ports. (Please refer to "The Getting started" of W-8xx7)
3. I-8xx7:
  - ComPort No. on slot 0: Com5 ~ Com8
  - ComPort No. on slot 1: Com9 ~ Com12
  - ComPort No. on slot 2: Com13 ~ Com16
  - ComPort No. on slot 3: Com17 ~ Com20
  - ComPort No. on slot 4 ~ 7 : do not support.
4. Integer array and word array use the same memory. Be careful if using both of them at the same time. (Refer to the description of Ary\_W\_W)

## COMCLEAR

- I-8x17/iP-8x17 ■ I-8x37/iP-8x47 ■ I-7188EG/7186EG ■ I-7188XG
- ISaGRAF WinCE PAC

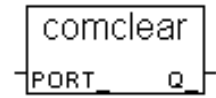

### Description : C\_Function

Clear the receiving buffer of COM PORT

### Input Parameters :

**PORT\_** Integer Port number, I-8xx7:1, 3 ~ 20; I-7188EG:1~8; I-7188XG:2~8; W-8xx7:2, 3, or ...

### Return :

**Q\_** Boolean TRUE: ok, False: fail.

## COMCLOSE

- I-8x17/iP-8x17 ■ I-8x37/iP-8x47 ■ I-7188EG/7186EG ■ I-7188XG
- ISaGRAF WinCE PAC



### Description : C\_Function

Close COM port

### Input Parameters :

**PORT\_** Integer Port number, I-8xx7:1, 3 ~ 20; I-7188EG:1~8; I-7188XG:2~8; W-8xx7:2, 3, or ...

### Return :

**Q\_** Boolean TRUE: ok; FALSE: fail.

### Note:

1. If use COM1 of I-8xx7 & I-7188EG, please preset COM1 as a non-Modbus-RTU port. (Please refer to Appendix C.1)
2. If use COM2 or COM3 of W-8xx7, please preset them as non-Modbus-RTU ports. (Please refer to "The Getting started" of W-8xx7)
3. I-8xx7:
  - ComPort No. on slot 0: Com5 ~ Com8
  - ComPort No. on slot 1: Com9 ~ Com12
  - ComPort No. on slot 2: Com13 ~ Com16
  - ComPort No. on slot 3: Com17 ~ Com20
  - ComPort No. on slot 4 ~ 7 : do not support.

### Example:

Please refer to the example of COMOPEN.

## COMOPEN

- I-8x17/iP-8x17 ■ I-8x37/iP-8x47 ■ I-7188EG/7186EG ■ I-7188XG
- ISaGRAF WinCE PAC

**Description : C\_Function**  
Open COM port

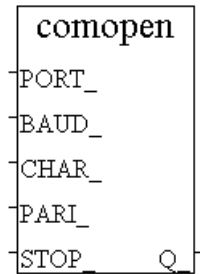

### Input Parameters :

<b>PORT_</b>	Integer	Port number, I-8xx7:1, 3 ~ 20; I-7188EG:1~8; I-7188XG:2~8; W-8xx7:2, 3, or ...
<b>BAUD_</b>	Integer	Baud rate, range: 300, 600, 1200, 2400, 4800, 9600, 19200, 38400, 57600, 115200
<b>CHAR_</b>	Integer	Character size, 7 or 8
<b>PARI_</b>	Integer	Parity, 0: none; 1: even; 2: odd; 3: Mark; 4: Space. (Parity of 3 & 4 is only for I-8xx7: COM3 to COM20, I-7188EG/XG: COM3 to COM8 & W-8xx7:COM2, or ...)
<b>STOP_</b>	Integer	Stop bit, 1 or 2

### Return :

**Q\_** Boolean TRUE: ok, FALSE: fail.

### Note:

1. If use COM1 of I-8xx7 & I-7188EG, please preset COM1 as a non-Modbus-RTU port.  
(Please refer to Appendix C.1)
2. If use COM2 or COM3 of W-8xx7, please preset them as non-Modbus-RTU ports.  
(Please refer to "The Getting started" of W-8xx7)
3. I-8xx7:
  - ComPort No. on slot 0: Com5 ~ Com8
  - ComPort No. on slot 1: Com9 ~ Com12
  - ComPort No. on slot 2: Com13 ~ Com16
  - ComPort No. on slot 3: Com17 ~ Com20
  - ComPort No. on slot 4 ~ 7 : do not support.

### Example:

Please refer to Chapter 11 - Demo\_21, 22 & 23.

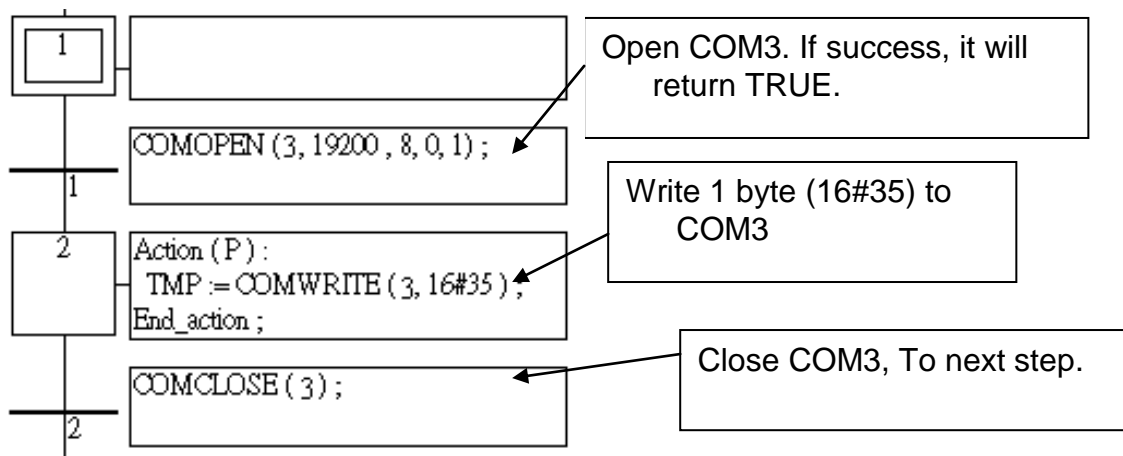



## COMOPEN2

- I-8x17/iP-8x17 □ I-8x37/iP-8x47 ■ I-7188EG/7186EG ■ I-7188XG
- ISaGRAF WinCE PAC

### Description : C\_Function

Open COM PORT with flow control (RS232 only)

### Input Parameters :

<b>PORT_</b>	Integer	Port number, I-7188EG/XG:3~8; W-8xx7:2, or ...
<b>BAUD_</b>	Integer	Baud rate, range: 300, 600, 1200, 2400, 4800, 9600, 19200, 38400, 57600, 115200
<b>CHAR_</b>	Integer	Character size, 7 or 8
<b>PARI_</b>	Integer	Parity, 0: none, 1: even, 2: odd, 3: mark, 4: space. (Parity of 3 & 4 is only for I-8xx7: COM3 to COM20, I-7188EG/XG: COM3 to COM8 & W-8xx7:COM2, or ...)
<b>STOP_</b>	Integer	Stop bit, 1 or 2
<b>FLOW_</b>	Boolean	True: hardware flow control (CTS / RTS) (7188EG/XG 3 ~ 5), False: software flow control (XON / XOF) (7188EG/XG 3 ~ 8)

### Return :

<b>Q_</b>	Boolean	TRUE: ok, FALSE: fail.
-----------	---------	------------------------

### Note:

If use COM2 of W-8xx7, please preset it as a non-Modbus-RTU port (Refer to “The Getting Started” of W-8xx7)

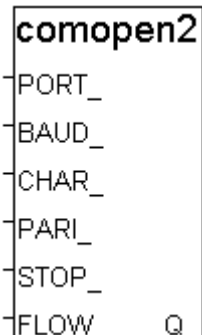

## COMREAD

- I-8x17/iP-8x17 ■ I-8x37/iP-8x47 ■ I-7188EG/7186EG ■ I-7188XG
- ISaGRAF WinCE PAC



### Description : C\_Function

Read 1 byte (unsigned 8-bit) from COM port

### Input Parameters :

**PORT\_** Integer Port number, I-8xx7:1, 3 ~ 20; I-7188EG:1~8; I-7188XG:2~8; W-8xx7:2, 3, or ...

### Return :

**Q\_** Integer The value of read byte (0~255)

### Note:

1. If use COM1 of I-8xx7 & I-7188EG, please preset COM1 as a non-Modbus-RTU port. (Refer to section of C.1)
2. If use COM2 or COM3 of W-8xx7, please preset them as non-Modbus-RTU ports. (Refer to "The Getting started" of W-8xx7)
3. I-8xx7:
  - ComPort No. on slot 0: Com5 ~ Com8
  - ComPort No. on slot 1: Com9 ~ Com12
  - ComPort No. on slot 2: Com13 ~ Com16
  - ComPort No. on slot 3: Com17 ~ Com20
  - ComPort No. on slot 4 ~ 7 : do not support.

**\* Before using COMREAD to read from COM, please use COMREADY to test if there is data from COM. If no data coming, use this function may cause Dead Lock.**

### Example:

Please refer to the example of "COMREADY".

## COMREADY

- I-8x17/iP-8x17 ■ I-8x37/iP-8x47 ■ I-7188EG/7186EG ■ I-7188XG
- ISaGRAF WinCE PAC



### Description : C\_Function

Test if any data coming from COM PORT

### Input Parameters :

**PORT\_** Integer Port number, I-8xx7:1, 3 ~ 20; I-7188EG:1~8; I-7188XG:2~8; W-8xx7:2, 3, or ...

### Return :

**Q\_** Boolean TRUE means there is data coming (Even just 1 byte)

### Note:

1. If use COM1 of I-8xx7 & I-7188EG, please preset COM1 as a non-Modbus-RTU port. (Refer to section of C.1)
2. If use COM2 or COM3 of W-8xx7, please preset them as non-Modbus-RTU ports. (Refer to "The Getting started" of W-8xx7)
3. I-8xx7:
  - ComPort No. on slot 0: Com5 ~ Com8
  - ComPort No. on slot 1: Com9 ~ Com12
  - ComPort No. on slot 2: Com13 ~ Com16
  - ComPort No. on slot 3: Com17 ~ Com20
  - ComPort No. on slot 4 ~ 7 : do not support.

**\* Before using COMREAD to read from COM, please use COMREADY to test if there is data from COM. If no data coming, use this function may cause Dead Lock.**

### Example:

Please refer to Chapter 11 - Demo\_21, 22 & 23.

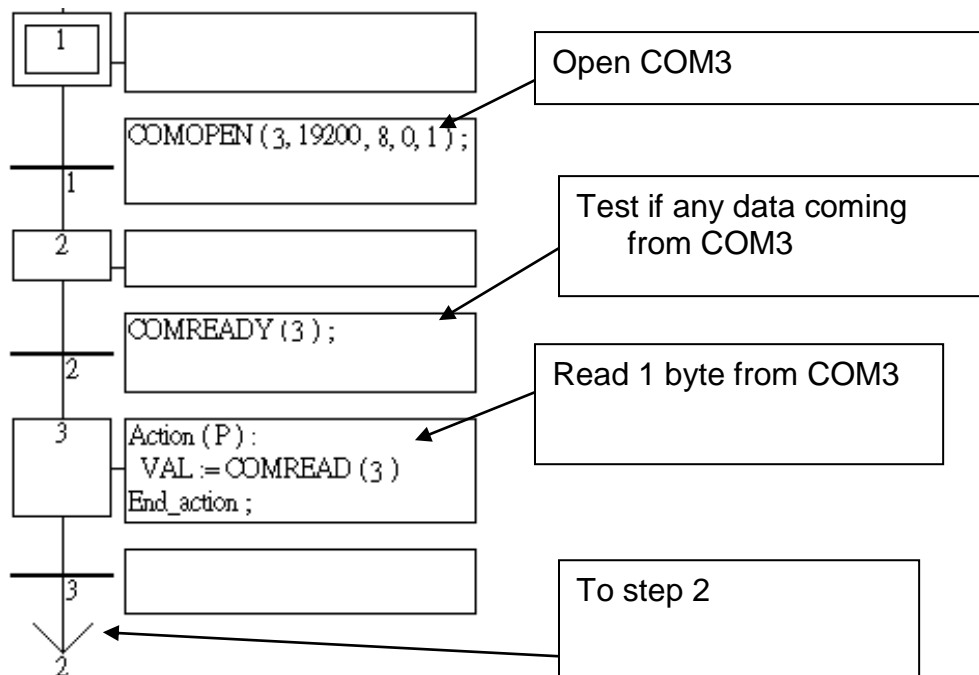

## COMSTR\_W

- I-8x17/iP-8x17
- I-8x37/iP-8x47
- I-7188EG/7186EG
- I-7188XG
- ISaGRAF WinCE PAC



### Description : C\_Function

Write a String to COM port

### Input Parameters :

- PORT\_** Integer Port number, I-8xx7:1, 3 ~ 20; I-7188EG:1~8; I-7188XG:2~8; W-8xx7:2, 3, or ...
- STR\_** Message The String to write (Max. length: 255).

### Return :

- Q\_** Boolean TRUE: ok, FALSE: fail.

### Note:

1. If use COM1 of I-8xx7 & I-7188EG, please preset COM1 as a non-Modbus-RTU port. (Refer to section of C.1)
2. If use COM2 or COM3 of W-8xx7, please preset them as non-Modbus-RTU ports. (Refer to "The Getting started" of W-8xx7)
3. I-8xx7:
  - ComPort No. on slot 0: Com5 ~ Com8
  - ComPort No. on slot 1: Com9 ~ Com12
  - ComPort No. on slot 2: Com13 ~ Com16
  - ComPort No. on slot 3: Com17 ~ Com20
  - ComPort No. on slot 4 ~ 7 : do not support.

### Example:

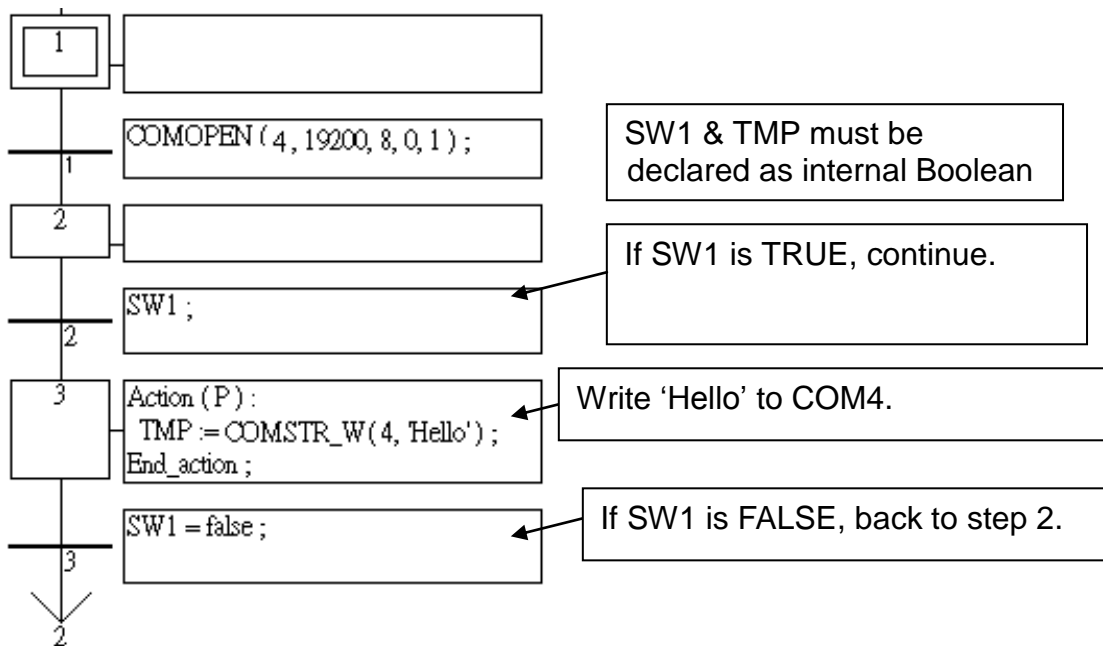

## COMWRITE

- I-8x17/iP-8x17 ■ I-8x37/iP-8x47 ■ I-7188EG/7186EG ■ I-7188XG
- ISaGRAF WinCE PAC

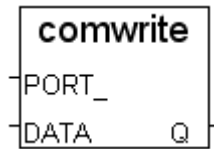

### Description : C\_Function

Write 1 byte (unsigned 8-bit) to COM port

### Input Parameters :

**PORT\_** Integer Port number, I-8xx7:1, 3 ~ 20; I-7188EG:1~8; I-7188XG:2~8; W-8xx7:2, 3, or ...

**DATA\_** Integer The byte to write (0 ~ 255)

### Return :

**Q\_** Boolean TRUE: ok, FALSE: fail.

### Note:

1. If use COM1 of I-8xx7 & I-7188EG, please preset COM1 as a non-Modbus-RTU port. (Refer to section of C.1)
2. If use COM2 or COM3 of W-8xx7, please preset them as non-Modbus-RTU ports. (Refer to "The Getting started" of W-8xx7)
3. I-8xx7:
  - ComPort No. on slot 0: Com5 ~ Com8
  - ComPort No. on slot 1: Com9 ~ Com12
  - ComPort No. on slot 2: Com13 ~ Com16
  - ComPort No. on slot 3: Com17 ~ Com20
  - ComPort No. on slot 4 ~ 7 : do not support.

### Example:

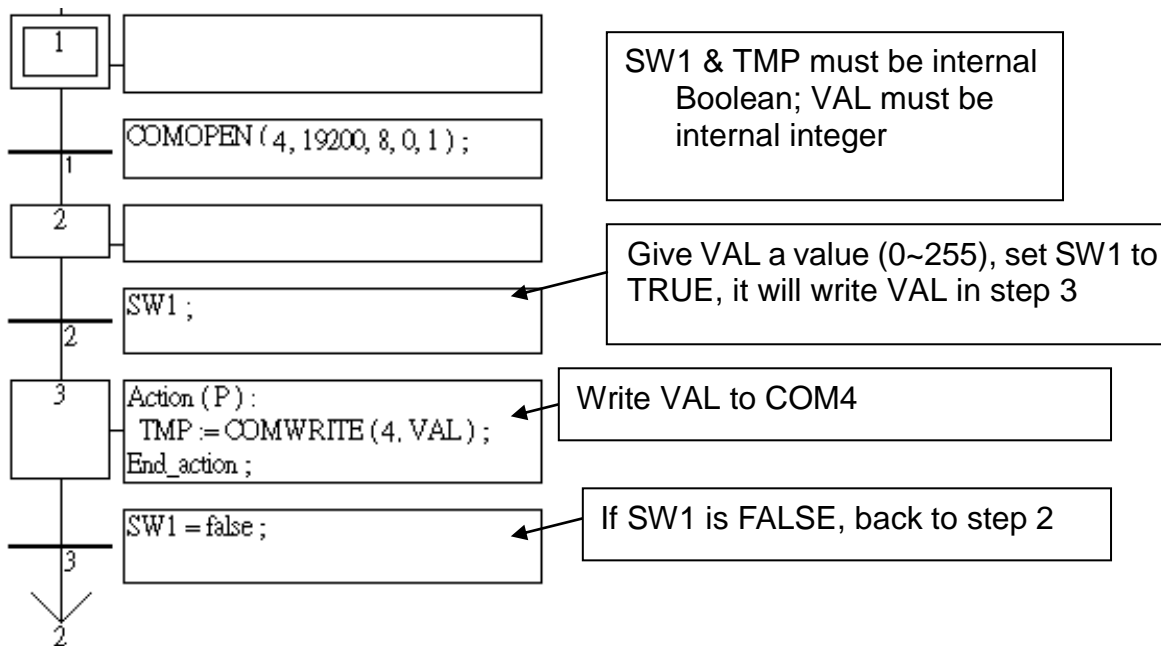

## CRC\_16

- I-8x17/iP-8x17 ■ I-8x37/iP-8x47 ■ I-7188EG/7186EG ■ I-7188XG
- ISaGRAF WinCE PAC

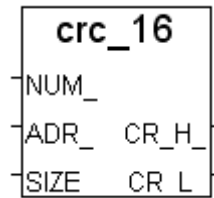

Use the algorithm of Section 5.3.

### Description : C\_Function Block

Calculate CRC\_16 checksum value from byte array

#### Input Parameters :

- |              |         |  |
|--------------|---------|--|
| <b>NUM_</b>  | Integer | The byte array number to be calculated,<br>Range: I-8xx7 & I-7188EG/XG: 1~24; Wincon-8xx7: 1~48; |
| <b>ADR_</b>  | Integer | Starting address to calculate in this array (1 ~ 256)  |
| <b>SIZE_</b> | Integer | Total byte count to calculate  |

#### Return :

- |              |         |                                       |
|--------------|---------|---------------------------------------|
| <b>CR_H_</b> | Integer | High byte of CRC-16 after calculation |
| <b>CR_L_</b> | Integer | Low byte of CRC-16 after calculation  |

#### Example:

TMP is declared to be internal Boolean. ii, CR\_H\_ & CR\_L\_ are internal integers, CRC16\_1 is FB instance with type of CRC\_16.

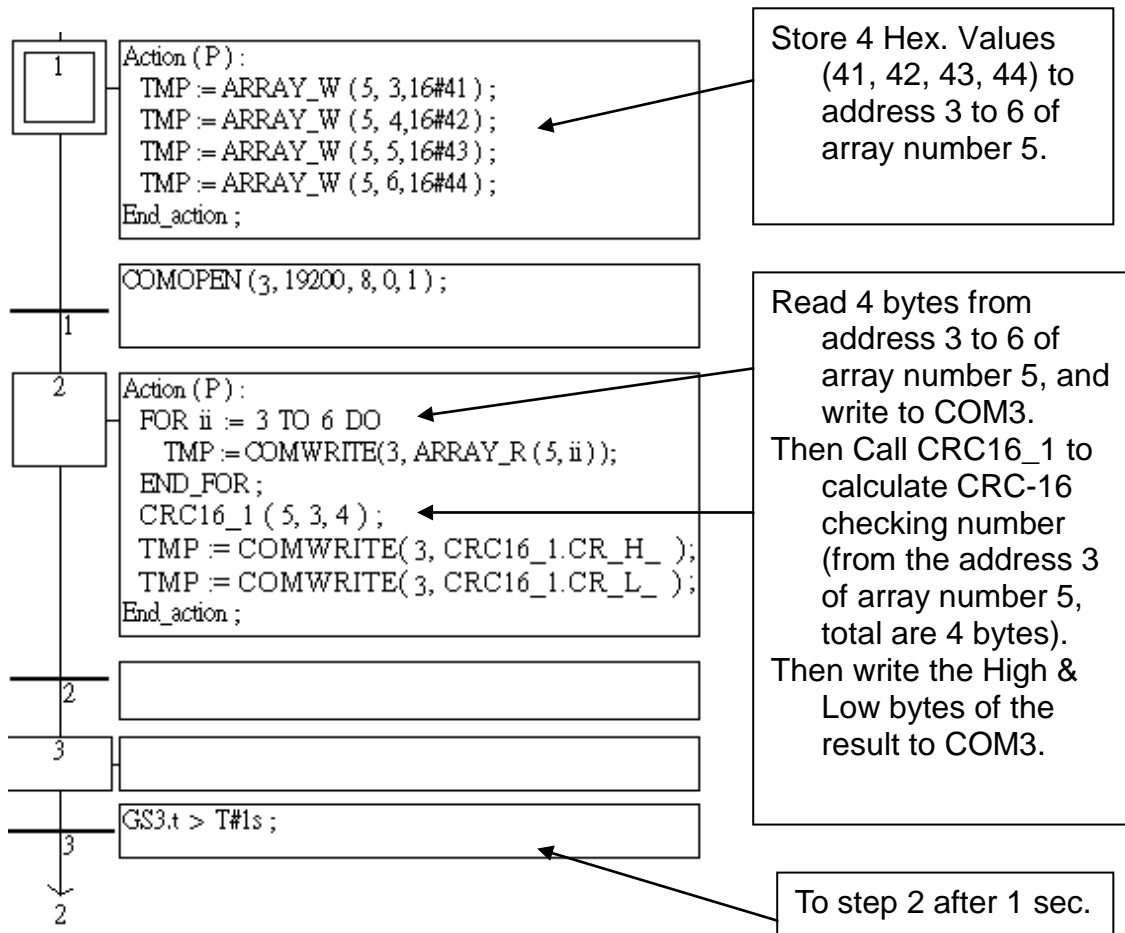

## DI\_CNT

- I-8x17/iP-8x17 ■ I-8x37/iP-8x47 ■ I-7188EG/7186EG ■ I-7188XG
- ISaGRAF WinCE PAC

### Description : C\_Function Block

Get parallel D/I counter at slot 0 of I-8xx7 & I-7188EG/XG, or slot 1 of W-8xx7, please refer to Section 3.8

#### Input Parameters:

**RS1\_ ~ RS8\_** Boolean Reset the associated D/I counter to 0 when rising from False to True

#### Return:

**Q\_** Boolean TRUE: work ok. FALSE: no parallel D/I modules is found at slot 0 (I-8xx7 & I-7188EG/XG) or slot 1 (W-8xx7).

**CN1\_ ~ CN8\_** Integer D/I Counter value of Ch.1 to Ch.8. (0 ~ 2,147,483,647), If Value is over 2,147,483,647, it restarts at 0.

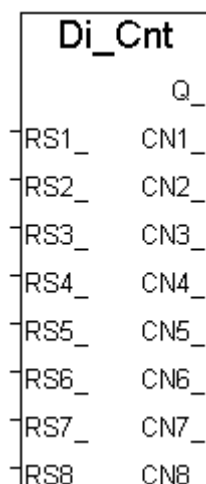

#### Note :

1. The related parallel D/I modules in I-8xx7 & I-7188EG/XG should be plugged at slot 0.
2. The related parallel D/I modules in W-8xx7/8xx6 should be plugged at slot 1.
3. Only Ch.1 to Ch.8 support Di\_Cnt.
4. I-7188EG/XG must plug an Xxxx card at slot 0 then using "Di\_Cnt" is possible.
5. The max frequency of counter input in I-8xx7 & I-7188EG/XG is up to 500 Hz with minimum pulse width of 1 ms.
6. The max frequency of counter input in W-8xx7 is up to 250 Hz with minimum pulse width of 2 ms.
7. Reset Counter channels: 8 , Reset the D/I counter when rising from False to True  
Counter value channels: 8 , valid value from 0 to 2,147,483,647 .

**Example:** W-8xx7: Wdemo\_22 , I-8xx7: demo\_63

## DT2MESAG

- I-8x17/iP-8x17 ■ I-8x37/iP-8x47 ■ I-7188EG/7186EG ■ I-7188XG
- ISaGRAF WinCE PAC

### Description : C\_Function

Convert Date & Time to Message

#### Input Parameters :

**DAY\_** Integer Day (1~31)  
**MONTH\_** Integer Month (1~12)  
**YEAR\_** Integer Year, Ex. 01,02  
**HOUR\_** Integer Hour (0~23)  
**MINUTE\_** Integer Minute (0~59)  
**SECOND\_** Integer Second (0~59)

#### Return :

**MESSAGE\_:** Message "day.month.year hours:minutes:seconds",  
Ex: "20.01.07 11:05:40"

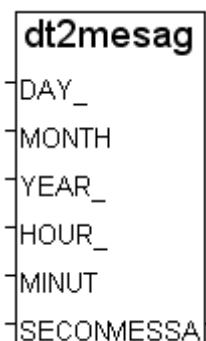

#### Note :

If input parameter is not correct, the return Message will be ". (Empty Message).

## EBUS\_B\_R

- I-8x17/iP-8x17 ■ I-8x37/iP-8x47 ■ I-7188EG/7186EG □ I-7188XG
- ISaGRAF WinCE PAC

### Description : C\_Function Block

Read a Boolean package from the Ebus device

#### Input Parameters:

**PACK\_** Integer Which package No. to read  
I-8xx7, I-7188EG/XG: 1 ~ 128  
ISaGRAF WinCE PAC: 1~256

#### Return :

**B1\_ ~ B8\_** Boolean The 8 Boolean values contained in the package

**Note:** Refer to Section 7.5

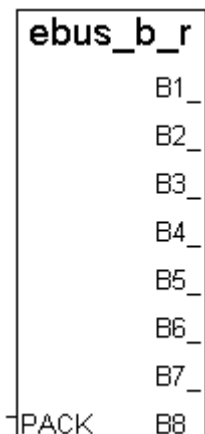

## EBUS\_B\_W

- I-8x17/iP-8x17 ■ I-8x37/iP-8x47 ■ I-7188EG/7186EG □ I-7188XG
- ISaGRAF WinCE PAC

### Description : C\_Function Block

Write a Boolean package to the Ebus device

#### Input Parameters:

**PACK\_** Integer Which package No. to write on  
I-8xx7, I-7188EG/XG: 1 ~ 128  
ISaGRAF WinCE PAC: 1~256

**B1\_ ~ B8\_** Boolean The 8 Boolean values contained in the package

#### Return :

**Q** Boolean Return TRUE always.

**Note:** Refer to Section 7.5

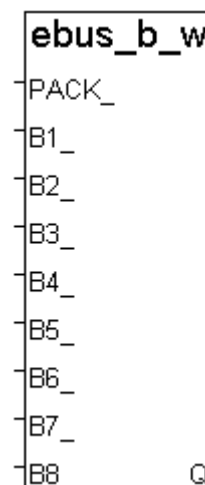



## EBUS\_F\_R

□ I-8x17/iP-8x17 ■ I-8x37/iP-8x47 ■ I-7188EG/7186EG □ I-7188XG  
■ ISaGRAF WinCE PAC

### Description : C\_Function Block

Read a Real package from the Ebus device

#### Input Parameters:

**PACK\_NO\_** Integer which package No. to read  
I-8xx7, I-7188EG/XG : 1 ~ 128  
ISaGRAF WinCE PAC : 1~256

#### Return :

**F1\_ ~ F8\_** Real The 8 Real values contained in the package  
If any wrong, return 1.23E-20.

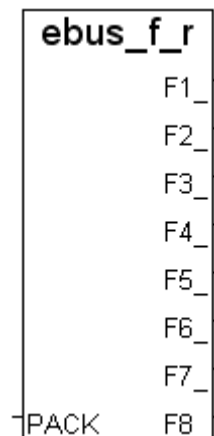

#### Note:

1. "EBUS\_F\_R" & "EBUS\_N\_R" use the same memory space.
2. Please **DO NOT** use INTEGER and REAL with the same package No., or it will return error. It may cause the error: "ERROR 115: EBUS\_F\_R Float error".

## EBUS\_F\_W

□ I-8x17/iP-8x17 ■ I-8x37/iP-8x47 ■ I-7188EG/7186EG □ I-7188XG  
■ ISaGRAF WinCE PAC

### Description : C\_Function Block

Write a Real package to the Ebus device

#### Input Parameters:

**PACK\_** Integer Which package No. to write on  
I-8xx7, I-7188EG/XG: 1 ~ 128  
ISaGRAF WinCE PAC: 1~256

**F1\_ ~ F8\_** Real The 8 Real values contained in the package

#### Return :

**Q** Boolean Return TRUE always.

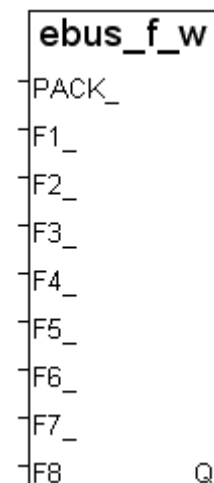

#### Note:

1. "EBUS\_F\_W" & "EBUS\_N\_W" use the same memory space.
2. Please **DO NOT** use INTEGER and REAL with the same package number, or it will return error. It may cause the error: " ERROR 115: EBUS\_F\_R float error".
3. For using EBUS\_F\_R and EBUS\_F\_W, the driver must be the version listed below or higher version:
  - I-7188EG : since ver. 2.17
  - I-7188XG : since ver. 2.15
  - I-8xx7 : since ver. 3.19
  - W-8xx7 : recommend upgrade to ver. 3.36 or higher version

## EBUS\_N\_R

- I-8x17/iP-8x17 ■ I-8x37/iP-8x47 ■ I-7188EG/7186EG □ I-7188XG
- ISaGRAF WinCE PAC

### Description : C\_Function Block

Read an Integer package from the Ebus device

#### Input Parameters:

**PACK\_** Integer Which package number to read.  
I-8xx7, I-7188EG/XG : 1 ~ 128  
ISaGRAF WinCE PAC : 1~256

#### Return :

**N1\_ ~ N8\_** Integer The 8 integer values contained in the package

**Note:** refer to Section 7.5.

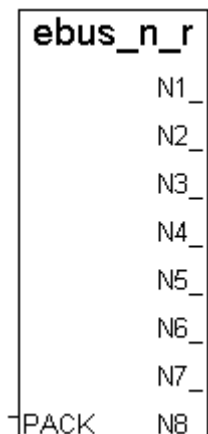

## EBUS\_N\_W

- I-8x17/iP-8x17 ■ I-8x37/iP-8x47 ■ I-7188EG/7186EG □ I-7188XG
- ISaGRAF WinCE PAC

### Description : C\_Function Block

Write an Integer package to the Ebus device,

#### Input Parameters:

**PACK\_** Integer Write which package No  
I-8xx7, I-7188EG/XG : 1 ~ 128  
ISaGRAF WinCE PAC : 1~256

**N1\_ ~ N8\_** Boolean The 8 integer values contained in the package

#### Return :

**Q** Boolean Return TRUE always.

**Note:** Refer to Section 7.5

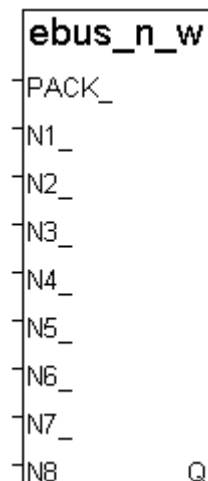

## EBUS\_STS

- I-8x17/iP-8x17 ■ I-8x37/iP-8x47 ■ I-7188EG/7186EG □ I-7188XG
- ISaGRAF WinCE PAC

### Description : C\_Function

Get package status of Ebus

#### Input Parameters:

**ID\_** Integer Which package type? (0~1)  
0: Boolean package, 1: Integer package

**PACK\_** Integer Which package No?  
I-8xx7, I-7188EG/XG: 1 ~ 128  
ISaGRAF WinCE PAC: 1~256

#### Return :

**Q\_** Boolean TRUE: Package is alive, FALSE: Package is dead  
Reasons may cause the package dead: Ebus\_m controller did not enable the package number, communication breakdown, the controller for sending that package is dead, Ebus\_m controller is dead, and so on.

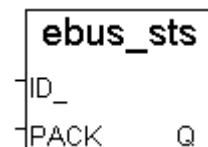

## EEP\_B\_R

- I-8x17/iP-8x17 ■ I-8x37/iP-8x47 ■ I-7188EG/7186EG ■ I-7188XG
- ISaGRAF WinCE PAC

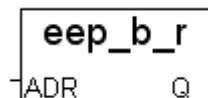

### Description : C\_Function

Read a Boolean from EEPROM

### Input Parameters :

**ADR\_** Integer Which address to read  
I-8xx7 & I-7188EG/XG: (1 ~ 256) ,  
ISaGRAF WinCE PAC: (1 ~ 1024)  
μPAC-7186EG, μPAC -5xx7, iP-8xx7, VP-2117: (1 ~ 1024)

### Return :

**Q\_** Boolean The Boolean returned.

## EEP\_B\_W

- I-8x17/iP-8x17 ■ I-8x37/iP-8x47 ■ I-7188EG/7186EG ■ I-7188XG
- ISaGRAF WinCE PAC

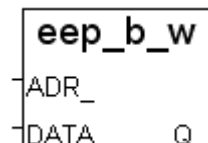

### Description : C\_Function

Write 1 Boolean to EEPROM

### Input Parameters :

**ADR\_** Integer The address be write to  
I-8xx7 & I-7188EG/XG: (1 ~ 256) ,  
ISaGRAF WinCE PAC: (1 ~ 1024)  
μPAC-7186EG, μPAC-5xx7, iP-8xx7, VP-2117: (1 ~ 1024)

**DATA\_** Boolean The Boolean to be write

### Return :

**Q\_** Boolean TRUE: ok.

### Note:

1. There is no operation limitation for reading from EEPROM.
2. There is some operation limitation for writing to EEPROM. (Refer to Section 10.2)
3. Before writing to EEPROM, user must use EEP\_EN to remove the EEPROM write protection.
4. To read/write EEPROM will consume lots of CPU time, and increase the PLC Scan Time a lot. Please use these functions very carefully.

**Example:** Refer to demo\_17.

## EEP\_BY\_R

■ I-8x17/iP-8x17 ■ I-8x37/iP-8x47 ■ I-7188EG/7186EG ■ I-7188XG ■ ISaGRAF WinCE PAC

### Description : C\_Function

Read one Byte (unsigned 8-bit) from EEPROM



### Input Parameters :

**ADR\_** Integer The address to read from  
I-8xx7 & I-7188EG/XG: (1 ~ 1512);  
ISaGRAF WinCE PAC: (1 ~ 6144);  
µPAC-7186EG, µPAC-5xx7, iP-8xx7, VP-2117, W-8xx7: (1 ~ 14272)

### Return :

**Q\_** Integer The byte returned (0~255)

## EEP\_BY\_W

■ I-8x17/iP-8x17 ■ I-8x37/iP-8x47 ■ I-7188EG/7186EG ■ I-7188XG ■ ISaGRAF WinCE PAC

### Description : C\_Function

Write one Byte (unsigned 8-bit) to EEPROM

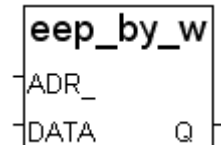

### Input Parameters :

**ADR\_** Integer The address be write to  
I-8xx7 & I-7188EG/XG: (1 ~ 1512);  
ISaGRAF WinCE PAC: (1 ~ 6144);  
µPAC-7186EG, µPAC-5xx7, iP-8xx7, VP-2117, W-8xx7: (1 ~ 14272)

**DATA\_** Integer The byte to be write (0 ~ 255)

### Return :

**Q\_** Boolean TRUE: ok.

## EEP\_EN

■ I-8x17/iP-8x17 ■ I-8x37/iP-8x47 ■ I-7188EG/7186EG ■ I-7188XG ■ ISaGRAF WinCE PAC

### Description : C\_Function

Remove the EEPROM write protection

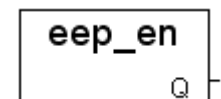

### Return :

**Q\_** Boolean TRUE: ok.

### Note :

1. EEP\_BY\_R, EEP\_BY\_W, EEP\_WD\_R, EEP\_WD\_W, EEP\_N\_R, EEP\_N\_W, EEP\_F\_R & EEP\_F\_W functions use the same memory space, please be very careful when using them. The address numbers listed below use the same memory space:

Byte	4n-3, 4n-2, 4n-1, 4n	(* n = 1, 2, ... *)
Word	2n-1, 2n	
Integer, Real	n	

2. There is some operation limitation for writing to EEPROM. (Refer to Section 10.2)
3. Before writing to EEPROM, user must use EEP\_EN to remove the EEPROM write protection.
4. To read/write EEPROM will consume lots of CPU time, and increase the PLC Scan Time a lot. Please use these functions very carefully.

**Example:** Please refer to Chapter 11: demo\_17.

## EEP\_F\_R

- I-8x17/iP-8x17
- I-8x37/iP-8x47
- I-7188EG/7186EG
- I-7188XG
- ISaGRAF WinCE PAC



### Description : C\_Function

Read one Real from EEPROM

### Input Parameters :

**ADR\_** Integer Address to read (use the same EEPROM address as EEP\_N\_R)  
Range: I-8xx7 & I-7188EG/XG: (1 ~ 378);  
ISaGRAF WinCE PAC: (1 ~ 1536);  
µPAC-7186EG, µPAC-5xx7, iP-8xx7, VP-2117, W-8xx7: (1 ~ 3568).

### Return :

**Q\_** Real The Real returned. If ADR\_ is not in the range, Q\_ = 1.23E-20.  
If the value stored in EEPROM is not a REAL, Q\_ will be wrong,  
sometimes got the error: "ERROR 114: EEP\_F\_R float error".

### Important :

1. "EEP\_F\_R" & "EEP\_N\_R" use the same EEPROM address
2. Please **DO NOT** use INTEGER and REAL in the same EEPROM address, it will return error.  
It may cause the error: " ERROR 114: EEP\_F\_R float error".
3. To read/write EEPROM will consume lots of CPU time, especially the WRITE operation.  
Please use these functions very carefully.

### Note :

1. This function can be used even without calling the EEP\_EN function.
2. EEP\_BY\_R, EEP\_BY\_W, EEP\_WD\_R, EEP\_WD\_W, EEP\_N\_R, EEP\_N\_W, EEP\_F\_R & EEP\_F\_W functions use the same memory space. Please be very careful when using them.  
Ex: ADR\_ 2 of EEP\_N\_R use 4 bytes. It is the same memory space with the ADR\_ 3, 4 of EEP\_WD\_R and the ADR\_ 5, 6, 7, 8 of EEP\_BY\_R.
3. W-8xx7/8xx6 use the 16<sup>th</sup> ~ 31<sup>st</sup> segments of EEPROM to store Boolean (64 bytes per segment), 32<sup>nd</sup> ~ 254<sup>th</sup> segments to store Byte, Word and Long. The 0<sup>th</sup> ~ 15<sup>th</sup> segments are no use. The 255<sup>th</sup> segment is reserved.
4. For using EEP\_F\_R and EEP\_F\_W, the driver must be the version listed below or higher version:
  - I-7188EG : since ver. 2.17
  - I-7188XG : since ver. 2.15
  - I-8xx7 : since ver. 3.19
  - W-8xx7 : recommend upgrade to ver. 3.36 or higher version

## EEP\_F\_W

- I-8x17/iP-8x17 ■ I-8x37/iP-8x47 ■ I-7188EG/7186EG ■ I-7188XG
- ISaGRAF WinCE PAC

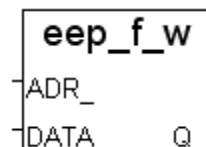

### Description : C\_Function

Write one Real to EEPROM

### Input Parameters :

- |              |         |  |
|--------------|---------|--|
| <b>ADR_</b>  | Integer | Address be write to (use the same EEPROM address as EEP_N_W)<br>Range: I-8xx7 & I-7188EG/XG: (1 ~ 378);<br>ISaGRAF WinCE PAC: (1 ~ 1536);<br>μPAC-7186EG, μPAC-5xx7, iP-8xx7, VP-2117, W-8xx7: (1 ~ 3568). |
| <b>DATA_</b> | Real    | The written Real   |

### Return :

- |           |         |                        |
|-----------|---------|------------------------|
| <b>Q_</b> | Boolean | TRUE: ok, FALSE: fail. |
|-----------|---------|------------------------|

### Important :

1. "EEP\_F\_W" & "EEP\_N\_W" use the same EEPROM address
2. Please **DO NOT** use INTEGER and REAL in the same EEPROM address, it will return error.  
It may cause the error: " ERROR 114: EEP\_F\_R float error"
3. To read/write EEPROM will consume lots of CPU time, especially the WRITE operation.  
Please use the functions very carefully.

### Note :

1. User must use EEP\_EN to remove the EEPROM write protection before writing to EEPROM.
2. If you are using this function with the EEP\_WD\_R, EEP\_WD\_W, EEP\_BY\_R, and EEP\_BY\_W functions simultaneously, you must be careful to arrange the ADR\_ because they all occupy the same memory area. For example, ADR\_2 of EEP\_N\_R occupies 4 bytes, and it uses the same memory area as ADR\_3 and ADR\_4 of EEP\_WD\_R and the same address of ADR\_5, 6, 7, and 8 of EEP\_BY\_R.
3. The EEP\_B\_W, EEP\_BY\_W, EEP\_WD\_W and EEP\_N\_W functions should not be used to write to the EEPROM more than 100,000 times. Over writing will damage the EEPROM.
4. Before "write", call EEP\_EN() to remove the EEPROM write portection.
5. After "write", you may call EEP\_PR() to protect the EEPROM.
6. W-8xx7/8xx6 use the 16<sup>th</sup> ~ 31<sup>st</sup> segments of EEPROM to store Boolean (64 bytes per segment), 32<sup>nd</sup> ~ 254<sup>th</sup> segments to store Byte, Word and Long. The 0<sup>th</sup> – 15<sup>th</sup> segments are no use. The 255<sup>th</sup> segment is reserved.
7. For using EEP\_F\_R and EEP\_F\_W, the driver must be the version listed below or higher version:

I-7188EG : since ver. 2.17

I-7188XG : since ver. 2.15

I-8xx7 : since ver. 3.19

W-8xx7 : suggest upgrade to ver. 3.36 or higher version

## EEP\_N\_R

- I-8x17/iP-8x17 ■ I-8x37/iP-8x47 ■ I-7188EG/7186EG ■ I-7188XG
- ISaGRAF WinCE PAC

### Description : C\_Function

read a signed 32-bit integer value from the EEPROM

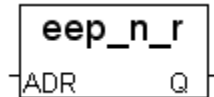

### Input Parameters :

**ADR\_** Integer Address in the EEPROM where the 32-bit Integer value is stored.  
Range: I-8xx7 & I-7188EG/XG: (1 ~ 378);  
ISaGRAF WinCE PAC: (1 ~ 1536);  
 $\mu$ PAC-7186EG,  $\mu$ PAC-5xx7, iP-8xx7, VP-2117, W-8xx7: (1 ~ 3568).

### Return :

**Q\_** Integer The signed 32-bit Integer value returned

### Note:

1. If you are using this function with the EEP\_WD\_R, EEP\_WD\_W, EEP\_BY\_R, and EEP\_BY\_W functions simultaneously, you must be careful to arrange the ADR\_ because they all occupy the same memory area.

Byte	$4n-3, 4n-2, 4n-1, 4n$	(* n = 1, 2, ... *)
Word	$2n-1, 2n$	
Integer, Real	n	

2. There is no number of times limitation for reading from EEPROM. User can use EEP\_N\_R to read from EEPROM whatever using or not using EEP\_EN to remove the protection of EEPROM
3. There is number of times limitation for writing to EEPROM. (Refer to Section 10.2)

**Example:** Please refer to Chapter 11: demo\_17

## EEP\_N\_W

- I-8x17/iP-8x17 ■ I-8x37/iP-8x47 ■ I-7188EG/7186EG ■ I-7188XG
- ISaGRAF WinCE PAC

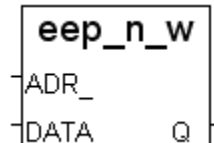

### Description : C\_Function

Write a signed 32-bit Integer value to the EEPROM

### Input Parameters :

**ADR\_** Integer Address in EEPROM where the 32-bit Integer value will be written to  
Range: I-8xx7 & I-7188EG/XG: (1 ~ 378);  
ISaGRAF WinCE PAC: (1 ~ 1536);  
 $\mu$ PAC-7186EG,  $\mu$ PAC-5xx7, iP-8xx7, VP-2117, W-8xx7: (1 ~ 3568).

**DATA\_** Integer The 32-bit Integer value to be written to

### Return :

**Q\_** Boolean TRUE: ok.

### Note:

1. If you are using this function with the EEP\_WD\_R, EEP\_WD\_W, EEP\_BY\_R, and EEP\_BY\_W functions simultaneously, you must be careful to arrange the ADR\_ because they all occupy the same memory area.

Byte	4n-3, 4n-2, 4n-1, 4n	(* n = 1, 2, ... *)
Word	2n-1, 2n	
Integer, Real	n	

2. There is number of times limitation for writing to EEPROM. (Refer to Section 10.2)
3. Before writing, please call EEP\_EN to remove the EEPROM write protection.
4. To read/write EEPROM will consume lots of CPU time, and may increase the PLC Scan time a lot. Please use the functions very carefully.

**Example:** Please refer to demo\_17 of Chapter 11.

## EEP\_PR

- I-8x17/iP-8x17 ■ I-8x37/iP-8x47 ■ I-7188EG/7186EG ■ I-7188XG
- ISaGRAF WinCE PAC

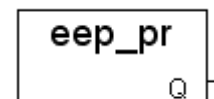

### Description : C\_Function

Protect EEPROM, write operation is not allowed

### Return :

**Q\_** Boolean TRUE: ok

### Note :

- \* There is number of times limitation for writing to EEPROM. (Refer to Section 10.2)
- \* Before writing, call EEP\_EN to remove the EEPROM write protection.

**Example:** Please refer to demo\_17 of Chapter 11.



## EEP\_WD\_R

- I-8x17/iP-8x17 ■ I-8x37/iP-8x47 ■ I-7188EG/7186EG ■ I-7188XG
- ISaGRAF WinCE PAC

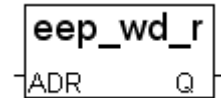

### Description : C\_Function

Read a Word (signed 16-bit Integer) value from the EEPROM

### Input Parameters :

**ADR\_** Integer Address in the EEPROM where the word value is stored  
I-8xx7 & I-7188EG/XG: (1 ~ 756);  
ISaGRAF WinCE PAC: (1 ~ 3072);  
μPAC-7186EG, μPAC-5xx7, iP-8xx7, VP-2117, W-8xx7: (1 ~ 7136).

### Return :

**Q\_** Integer The returned Word value (-32768 ~ +32767)

## EEP\_WD\_W

- I-8x17/iP-8x17 ■ I-8x37/iP-8x47 ■ I-7188EG/7186EG ■ I-7188XG
- ISaGRAF WinCE PAC

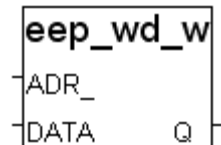

### Description : C\_Function

Write a Word (signed 16-bit Integer) value to the EEPROM

### Input Parameters :

**ADR\_** Integer Address in the EEPROM where the Word value is to be written to.  
I-8xx7 & I-7188EG/XG: (1 ~ 756);  
ISaGRAF WinCE PAC: (1 ~ 3072)  
μPAC-7186EG, μPAC-5xx7, iP-8xx7, VP-2117, W-8xx7: (1 ~ 7136).

**DATA\_** Integer The word value to be written to (-32768 ~ 32767)

### Return :

**Q\_** Boolean TRUE: ok.

### Note:

1. If you are using this function with the EEP\_WD\_R, EEP\_WD\_W, EEP\_BY\_R, and EEP\_BY\_W functions simultaneously, you must be careful to arrange the ADR\_ because they all occupy the same memory area.

Byte	4n-3, 4n-2, 4n-1, 4n	(* n = 1, 2, ... *)
Word	2n-1, 2n	
Integer	n	

2. There is number of times limitation for writing to EEPROM. (Refer to Section 10.2)
3. Before writing, please call EEP\_EN to remove the EEPROM write protection.
4. To read/write EEPROM will consume lots of CPU time, and may increase the PLC Scan time a lot. Please use the functions very carefully.

**Example:** Please refer to demo\_17 of Chapter 11.

## F\_APPEND

- I-8x17/iP-8x17 □ I-8x37/iP-8x47 □ I-7188EG/7186EG □ I-7188XG
- ISaGRAF WinCE PAC

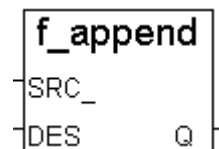

### Description : C\_Function

Append one file to the other file

#### Input Parameters :

**SRC\_** Message File path of source file. Ex: '\Micro\_SD\data.txt'  
**DES\_** Message File path of destination file. Ex: '\Micro\_SD\data1.txt'

#### Return :

**Q\_** Boolean True: Ok, False: Fail

#### Note:

1. If one of these two files is not found, return FALSE.
2. Source and destination file should be closed, not opened.
3. Please refer to ISaGRAF standard function F\_wopen , F\_ropen , F\_close , F\_eof , Fa\_read , Fa\_write (F\_wopen: Open existing file for Read & Write)
4. Please refer to ICP DAS functions for ISaGRAF: F\_creat, F\_copy, F\_append, F\_dir, F\_end, F\_seek, F\_writ\_b, F\_writ\_f, F\_writ\_s, F\_writ\_w
5. To do the file operation in the \Micro\_SD and \System\_disk of WP-8xx7, WP-5xx7 and VP-2xW7 (or \System\_disk2 and \System\_disk of XP-8xx7-CE6 and XP-8xx7-Atom-CE6) will consume much more CPU time. To do the file operation in RAM Disk, such as in \Temp\, will be better, but it will lost the file content after turning off the controller.

## F\_CLOSE

- I-8x17/iP-8x17 □ I-8x37/iP-8x47 □ I-7188EG/7186EG □ I-7188XG
- ISaGRAF WinCE PAC

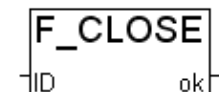

### Description : Standard\_Function

Close a Binary file opened with the function of F\_ROPEN, F\_WOPEN or F\_CREAT.

#### Input Parameters :

**ID** Integer The file number returned by F\_ROPEN, F\_WOPEN or F\_CREAT.

#### Return :

**OK** Boolean Return status  
TRUE: file closed ok; FALSE: file closed fail.

#### Example :

```
(* ST Program: *)
file_id := F_ROPEN('\Micro_SD\data.bin');
ok := F_CLOSE(file_id);

(* IL Equivalence: *)
LD      '\Micro_SD\data.bin'
F_ROPEN
ST      file_id
F_CLOSE      (* file_id is already in the current IL result *)
ST      ok
```

## F\_COPY

- I-8x17/iP-8x17 □ I-8x37/iP-8x47 □ I-7188EG/7186EG □ I-7188XG
- ISaGRAF WinCE PAC

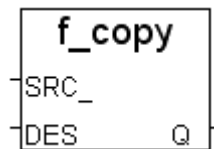

### Description : C\_Function

Copy one file to another one

### Input Parameters :

- |             |         |   |
|-------------|---------|---|
| <b>SRC_</b> | Message | File path & name of source file. Ex: '\Micro_SD\data.txt'       |
| <b>DES_</b> | Message | File path & name of destination file. Ex: '\Micro_SD\data1.txt' |

### Return :

- |           |         |                       |
|-----------|---------|-----------------------|
| <b>Q_</b> | Boolean | True: Ok, False: Fail |
|-----------|---------|-----------------------|

### Note:

1. Copy the SRC\_ file to the DES\_ file.
2. SRC\_ file and DES\_ file should be closed, but not opened.
3. If there is an old DES\_ file existing, it will be replaced by new contents.

## F\_CREAT

- I-8x17/iP-8x17 □ I-8x37/iP-8x47 □ I-7188EG/7186EG □ I-7188XG
- ISaGRAF WinCE PAC

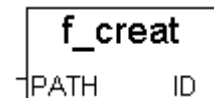

### Description : C\_Function

Create an empty file for reading & writing.

### Input Parameters :

- |              |         |  |
|--------------|---------|--|
| <b>Path_</b> | Message | File path & name. Ex: '\Micro_SD\data.txt' |
|--------------|---------|--|

### Return :

- |            |         |   |
|------------|---------|---|
| <b>ID_</b> | Integer | File ID returned. If error happens, it returns 0. |
|------------|---------|---|

### Note:

1. If file exists already, it will be destroyed.
2. For reading an existing file, please use the ISaGRAF standard function – “F\_ROPEN( )”
3. For writing an existing file, please use the ISaGRAF standard function – “F\_WOPEN( )”
4. Please refer to ISaGRAF standard functions: F\_wopen, F\_ropen, F\_close, F\_eof, Fa\_read, Fa\_write
5. Please refer to ICP DAS functions for ISaGRAF: F\_creat, F\_copy, F\_append, F\_dir, F\_end, F\_seek, F\_writ\_b, F\_writ\_f, F\_writ\_s, F\_writ\_w.
6. To do the file operation in the \Micro\_SD and \System\_disk of WP-8xx7, WP-5xx7 and VP-2xW7 (or \System\_disk2 and \System\_disk of XP-8xx7-CE6 and XP-8xx7-Atom-CE6) will consume much more CPU time. To do the file operation in RAM Disk, such as in \Temp\, will be better, but it will lost the file after turning off the controller.

**Example:** Wpdmo\_11 in WP-8xx7 CD-ROM:\napdos\isagraf\wp-8xx7\demo\ .

## F\_DELETE

□ I-8x17/iP-8x17 □ I-8x37/iP-8x47 □ I-7188EG/7186EG □ I-7188XG ■ ISaGRAF WinCE PAC

### Description : C\_Function

Delete a file

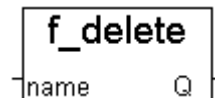

### Input Parameters :

**Name\_** Message File name. Ex: 'Micro\_SD\data.txt'

### Return :

**Q\_** Boolean True: Ok, False: fail

## F\_DIR

□ I-8x17/iP-8x17 □ I-8x37/iP-8x47 □ I-7188EG/7186EG □ I-7188XG ■ ISaGRAF WinCE PAC

### Description : C\_Function

Create a new directory

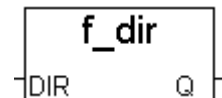

### Input Parameters :

**Dir\_** Message Directory name. Ex: '\DATA21'

### Return :

**Q\_** Boolean True: Ok, False: fail (Ex: Directory already exists)

### Example:

(\* init is declared as an internal Boolean variable with initial value = True \*)  
(\* tmp is declared as an internal Boolean variable \*)

```
if INIT then
  INIT := False ;
  TMP := f_dir('\DATA21') ;
End_if ;
```

## F\_END

□ I-8x17/iP-8x17 □ I-8x37/iP-8x47 □ I-7188EG/7186EG □ I-7188XG ■ ISaGRAF WinCE PAC

### Description : C\_Function

Move file position to End-Of-File

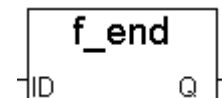

### Input Parameters :

**ID\_** Integer File ID No., (returned by F\_ROPEN , F\_WOPEN or F\_CREAT)

### Return :

**Q\_** Boolean True: Ok, False: Fail

### Note:

1. Please use F\_SEEK to move to a specified file position
2. Please refer to ISaGRAF standard functions: F\_wopen, F\_ropen, F\_close, F\_eof, Fa\_read, Fa\_write
3. Please refer to ICP DAS functions for ISaGRAF: F\_creat, F\_copy, F\_append, F\_dir, F\_end, F\_seek, F\_writ\_b, F\_writ\_f, F\_writ\_s, F\_writ\_w
4. To do the file operation in the \Micro\_SD and \System\_disk of WP-8xx7, WP-5xx7 and VP-2xW7 (or \System\_disk2 and \System\_disk of XP-8xx7-CE6 and XP-8xx7-Atom-CE6) will consume much more CPU time. To do the file operation in RAM Disk, such as in \Temp\, will be better, but it will lost the file after turning off the controller.

## F\_EOF

□ I-8x17/iP-8x17 □ I-8x37/iP-8x47 □ I-7188EG/7186EG □ I-7188XG ■ ISaGRAF WinCE PAC

### Description : Standard\_Function

Test if End Of File has been reached

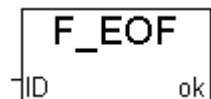

### Input Parameters :

**ID\_** Integer File ID No., (returned by F\_ROPEN , F\_WOPEN or F\_CREAT)

### Return :

**OK** Boolean True: reach End Of File, False: not yet

## F\_EXIST

□ I-8x17/iP-8x17 □ I-8x37/iP-8x47 □ I-7188EG/7186EG □ I-7188XG ■ ISaGRAF WinCE PAC

### Description : C\_Function

Test if a directory or a file exists.

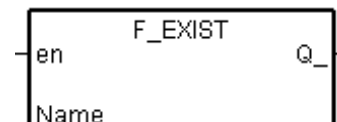

### Call:

**Name\_ message directory path name or file name.**  
For ex '\Micro\_SD\Dir2' , '\Micro\_SD\DTAT1.txt'

### Return:

**Q\_ boolean TRUE: exist , FASLE: not found.**

### Example:

(\* init is declared as an internal boolean variable with initial value = True \*)

(\* tmp is declared as an internal boolean variable \*)

```
if init then
  init := False ;
  tmp := f_exist('\Micro_SD\Dir2'); (* find a directory or a file *)
  if tmp = False then
    (* not found then create it *)
    tmp := f_dir('\Micro_SD\Dir2') ; (* create a directory *)
  end_if ;
end_if;
```

### Note:

1. Please refer to ISaGRAF standard function F\_wopen , F\_ropen , F\_close , F\_end , Fa\_read , Fa\_write.
2. Please refer to F\_creat , F\_copy , F\_append , F\_dir , F\_end , F\_seek , F\_writ\_b , F\_writ\_f , F\_writ\_s , F\_writ\_w.

## F\_READ\_B

□ I-8x17/iP-8x17 □ I-8x37/iP-8x47 □ I-7188EG/7186EG □ I-7188XG ■ ISaGRAF WinCE PAC

### Description : C\_Function

Read one Byte from current position of an open file



### Input Parameters :

**ID\_** Integer File ID No., (returned by F\_ROPEN( ), F\_CREAT( ) or F\_WOPEN( ))

### Return :

**Q\_** Integer The returned Byte (0 ~ 255)

## F\_READ\_F

□ I-8x17/iP-8x17 □ I-8x37/iP-8x47 □ I-7188EG/7186EG □ I-7188XG

■ ISaGRAF WinCE PAC

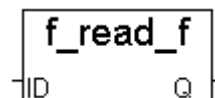

### Description : C\_Function

Read one Real (32-bit Float) value from current position of an open file

### Input Parameters :

**ID\_** Integer File ID No., (returned by F\_ROPEN , F\_WOPEN or F\_CREAT)

### Return :

**Q\_** Real The returned Real value (32-bit Float format)  
If the value is not 32-bit Float format, the returned value will be error.  
It may cause: "ERROR 117: F\_READ\_ error".

### Note:

1. Please use the ISaGRAF standard function –“FA\_READ” & “FA\_WRITE” to read/write the Long Integer (signed 32-Bit).
2. Please use the ISaGRAF standard function –“FM\_READ”, “FM\_WRITE” or “F\_writ\_s” to read/write String.
3. Refer to the usage of other ISaGRAF standard functions – F\_wopen, F\_ropen, F\_close, F\_eof, Fa\_read, Fa\_write.
4. Refer to the usage of ICP DAS functions for ISaGRAF – F\_creat, F\_copy, F\_append, F\_dir, F\_end, F\_seek, F\_writ\_b, F\_writ\_f, F\_writ\_s, F\_writ\_w.
5. To do the file operation in the \Micro\_SD and \System\_disk of WP-8xx7, WP-5xx7 and VP-2xW7 (or \System\_disk2 and \System\_disk of XP-8xx7-CE6 and XP-8xx7-Atom-CE6) will consume much more CPU time. To do the file operation in RAM Disk, such as in \Temp\, will be better, but it will lost the file after turning off the controller.

**Example:** Refer to WP-8xx7 CD:\napdos\isagraf\wp-8xx7\demo\ “wpdmo\_01” & “wpdmo\_02

## F\_READ\_W

- I-8x17/iP-8x17 □ I-8x37/iP-8x47 □ I-7188EG/7186EG □ I-7188XG
- ISaGRAF WinCE PAC

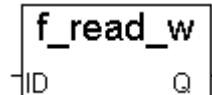

### Description : C\_Function

Read one Word (signed 16-bit Integer) from current position of an open file.

### Input Parameters :

**ID\_** Integer File ID No., (returned by F\_ROPEN , F\_WOPEN or F\_CREAT)

### Return :

**Q\_** Integer The returned word (-32768 ~ +32767)

## F\_ROPEN

- I-8x17/iP-8x17 □ I-8x37/iP-8x47 □ I-7188EG/7186EG □ I-7188XG
- ISaGRAF WinCE PAC



### Description : Standard\_Function

Open a Binary file in read mode.

### Input Parameters :

**Path\_** Message File name  
It may include the access path to the file using the \ or / symbol to specify a directory. To ease application portability, / or \ is equivalent.

### Return :

**ID\_** Integer File number  
0: error occurs or file does not exist.

### Example :

```
(* ST program: *)
file_id := F_ROPEN(' \Micro_SD\data.bin ');
error := (file_id=0);
```

```
(* IL Equivalence: *)
LD      '\Micro_SD\data.bin'
F_ROPEN
ST      file_id
EQ      0
ST      error
```

**Note:** To do the file operation in the \Micro\_SD and \System\_disk of WP-8xx7, WP-5xx7 and VP-2xW7 (or \System\_disk2 and \System\_disk of XP-8xx7-CE6 and XP-8xx7-Atom-CE6) will consume much more CPU time. To do the file operation in RAM Disk, such as in \Temp\, will be better, but it will lost the file after turning off the controller.

## F\_SEEK

- I-8x17/iP-8x17 □ I-8x37/iP-8x47 □ I-7188EG □ I-7188XG
- ISaGRAF WinCE PAC

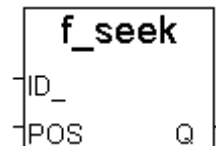

### Description : C\_Function

Move file position to a new position.....

#### Input Parameters :

**ID\_** Integer File ID No., (returned by F\_ROPEN , F\_WOPEN or F\_CREAT)  
**POS\_** Integer Position, unit is Byte (1 to ...)

#### Return :

**Q\_** Boolean True: ok. False: fail

## F\_TRIG

- I-8x17/iP-8x17 □ I-8x37/iP-8x47 □ I-7188EG/7186EG □ I-7188XG
- ISaGRAF WinCE PAC

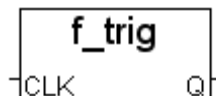

### Description : Standard\_Function

Detect a falling edge of a Boolean variable

#### Input Parameters :

**CLK\_** Boolean Any Boolean variable

#### Return :

**Q\_** Boolean TRUE: if CLK change from TRUE to FALSE  
FALSE: all other cases

#### Example :

(\* FBD Program \*)

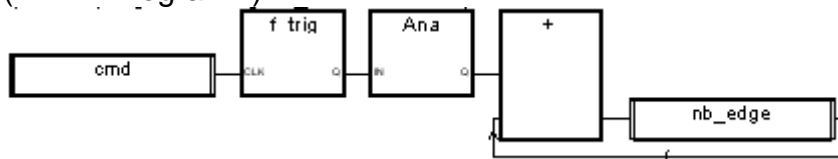

(\* ST Equivalence: We suppose F\_TRIG1 is an instance F\_TRIG block \*)

F\_TRIG1(cmd);

nb\_edge := ANA(F\_TRIG1.Q) + nb\_edge;

(\* IL Equivalence: \*)

LD cmd

ST F\_TRIG1.clk

CAL F\_TRIG1

LD F\_TRIG1.Q

ANA

ADD nb\_edge

ST nb\_edge



## F\_WOPEN

- I-8x17/iP-8x17 □ I-8x37/iP-8x47 □ I-7188EG/7186EG □ I-7188XG
- ISaGRAF WinCE PAC

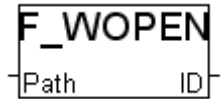

### Description : Standard\_Function

Open a Binary file in Write mode, then the file can be read/write.

### Input Parameters :

<b>Path</b>	Message	File name
-------------	---------	-----------

It may include the access path to the file using the \ or / symbol to specify a directory. To ease application portability, / or \ is equivalent.

### Return :

<b>ID</b>	Integer	File number
-----------	---------	-------------

0: error occurs. If file exists already, it will be overwritten.

### Example :

```
(* ST Program: *)
file_id := F_WOPEN('\Micro_SD\hello.dat');
error := (file_id=0);
```

```
(* IL Equivalence: *)
LD      '\Micro_SD\hello.dat'
F_WOPEN
ST      file_id
EQ      0
ST      error
```

**Note:** To do the file operation in the \Micro\_SD and \System\_disk of WP-8xx7, WP-5xx7 and VP-2xW7 (or \System\_disk2 and \System\_disk of XP-8xx7-CE6 and XP-8xx7-Atom-CE6) will consume much more CPU time. To do the file operation in RAM Disk, such as in \Temp\, will be better, but it will lost the file after turning off the controller.

## F\_WRIT\_B

- I-8x17/iP-8x17 □ I-8x37/iP-8x47 □ I-7188EG/7186EG □ I-7188XG
- ISaGRAF WinCE PAC

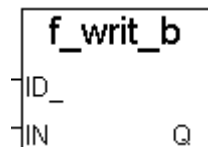

### Description : C\_Function

Write one Byte to current position of an open file

### Input Parameters :

<b>ID_</b>	Integer	File ID No., (returned by F_ROPEN , F_WOPEN or F_CREAT)
<b>IN_</b>	Integer	Byte value to write (0 ~ 255), if value > 255 or <0, the lowest byte is written

### Return :

<b>Q_</b>	Boolean	True: ok. False: fail
-----------	---------	-----------------------

### Note:

1. Using ISaGRAF standard function –“FA\_READ” & “FA\_WRITE” to read/write Long Integer (signed 32-bit)
2. Using ISaGRAF standard function –“FM\_READ” & “FM\_WRITE” or “F\_writ\_s” to read/write String.
3. Refer to the usage of ISaGRAF standard function – F\_wopen, F\_ropen, F\_close, F\_eof, Fa\_read, Fa\_write.
4. Refer to the ICP DAS functions for ISaGRAF – F\_creat, F\_copy, F\_append, F\_dir, F\_end, F\_seek, F\_writ\_b, F\_writ\_f, F\_writ\_s, F\_writ\_w.
5. To do the file operation in the \Micro\_SD and \System\_disk of WP-8xx7, WP-5xx7 and VP-2xW7 (or \System\_disk2 and \System\_disk of XP-8xx7-CE6 and XP-8xx7-Atom-CE6) will consume much more CPU time. To do the file operation in RAM Disk, such as in \Temp\, will be better, but it will lost the file after turning off the controller.

**Example:** Refer to WP-8xx7 CD:\napdos\isagraf\wp-8xx7\demo\ “wpdmo\_01” & “wpdmo\_02”

## F\_WRIT\_F

- I-8x17/iP-8x17 □ I-8x37/iP-8x47 □ I-7188EG/7186EG □ I-7188XG
- ISaGRAF WinCE PAC

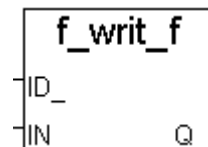

### Description : C\_Function

Write one Float value (32-bit format) to current position of an open file

### Input Parameters :

<b>ID_</b>	Integer	File ID No., (returned by F_ROPEN , F_WOPEN or F_CREAT)
<b>IN_</b>	Real	Float value to write (32-bit format)

### Return :

<b>Q_</b>	Boolean	True: ok. False: fail
-----------	---------	-----------------------

## F\_WRIT\_S

- I-8x17/iP-8x17 □ I-8x37/iP-8x47 □ I-7188EG/7186EG □ I-7188XG
- ISaGRAF WinCE PAC

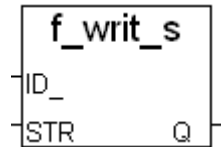

### Description : C\_Function

Write one String to current position of a file without <CR> <LF> at the end

### Input Parameters :

- |             |         |   |
|-------------|---------|---|
| <b>ID_</b>  | Integer | File ID No. (returned by F_ROPEN , F_WOPEN or F_CREAT ) |
| <b>STR_</b> | Message | Message (String) to write                               |

### Return :

- |           |         |                       |
|-----------|---------|-----------------------|
| <b>Q_</b> | Boolean | True: ok. False: fail |
|-----------|---------|-----------------------|

### Note:

1. “**FM\_write**” writes <CR> <LF> at the end of the message, but “**F\_writ\_s**” doesn’t.
2. Using ISaGRAF Standard Function –“**FA\_READ**” & “**FA\_WRITE**” to R/W Long Integer (signed 32-bit).
3. Using ISaGRAF Standard Function –“**FM\_READ**” or “**FM\_WRITE**” to R/W Message (String).
4. Refer to the usage of ISaGRAF standard function – F\_wopen, F\_ropen, F\_close, F\_eof, Fa\_read, Fa\_write.
5. Refer to the ICP DAS functions for ISaGARF – F\_creat, F\_copy, F\_append, F\_dir, F\_end, F\_seek, F\_writ\_b, F\_writ\_f, F\_writ\_s, F\_writ\_w.
6. To do the file operation in the \Micro\_SD and \System\_disk of WP-8xx7, WP-5xx7 and VP-2xW7 (or \System\_disk2 and \System\_disk of XP-8xx7-CE6 and XP-8xx7-Atom-CE6) will consume much more CPU time. To do the file operation in RAM Disk, such as in \Temp\, will be better, but it will lost the file after turning off the controller.

### Example:

Please refer to WP-8xx7 CD:\napdos\isagraf\wp-8xx7\demo\ “wpdmo\_01” & “wpdmo\_02”

## F\_WRIT\_W

- I-8x17/iP-8x17 □ I-8x37/iP-8x47 □ I-7188EG/7186EG □ I-7188XG
- ISaGRAF WinCE PAC

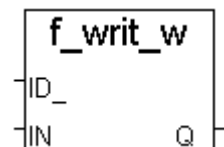

### Description : C\_Function

Write one Word value (signed 16-bit Integer) to current position of an open file.

### Input Parameters :

- |            |         |   |
|------------|---------|---|
| <b>ID_</b> | Integer | File ID No., (returned by F_ROPEN , F_WOPEN or F_CREAT) |
| <b>IN_</b> | Integer | Word to write (-32768 ~ +32767)                         |

### Return :

- |           |         |                       |
|-----------|---------|-----------------------|
| <b>Q_</b> | Boolean | True: ok. False: fail |
|-----------|---------|-----------------------|

## FA\_READ

- I-8x17/iP-8x17 □ I-8x37/iP-8x47 □ I-7188EG/7186EG □ I-7188XG
- ISaGRAF WinCE PAC

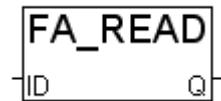

### Description : Standard\_Function

Read one Integer value (32-bit signed) from a Binary file.

### Input Parameters :

**ID** Integer File ID No. (returned by F\_ROPEN, F\_WOPEN or F\_CREAT)

### Return :

**Q** Integer Integer value read from file

### Example :

```
(* ST Program: *)
file_id := F_ROPEN('\Micro_SD\data.dat');
vinc := FA_READ(file_id);
delta_tim := tmr(FA_READ(file_id));
ok := F_CLOSE(file_id);
```

```
(* IL Equivalence: *)
LD '\Micro_SD\data.dat'
F_ROPEN
ST file_id
LD file_id
FA_READ (* read vinc *)
ST vinc
LD file_id
FA_READ (* read timer: delta_tim *)
TMR (* convert into a timer *)
ST delta_tim
LD file_id
F_CLOSE
ST ok
```

**Note:** To do the file operation in the \Micro\_SD and \System\_disk of WP-8xx7, WP-5xx7 and VP-2xW7 (or \System\_disk2 and \System\_disk of XP-8xx7-CE6 and XP-8xx7-Atom-CE6) will consume much more CPU time. To do the file operation in RAM Disk, such as in \Temp\, will be better, but it will lost the file after turning off the controller.

## FA\_WRITE

- I-8x17/iP-8x17 □ I-8x37/iP-8x47 □ I-7188EG/7186EG □ I-7188XG
- ISaGRAF WinCE PAC

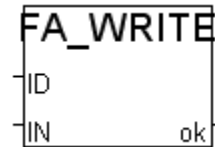

### Description : Standard\_Function

Write one Integer value (32-bit signed) to a Binary file.

### Input Parameters :

<b>ID</b>	Integer	File ID No. (returned by F_ROPEN, F_WOPEN or F_CREAT).
<b>IN</b>	Integer	Integer value be write to file

### Return :

<b>OK</b>	Boolean	execution status. TRUE: ok
-----------	---------	----------------------------

### Example :

```
(* ST Program: *)
file_id := F_WOPEN('\Micro_SD\data.dat');
nb_written := 0;
nb_written := nb_written + ana(FA_WRITE(file_id,vstart));
ok := F_CLOSE(file_id);
IF ( nb_written <> 4) THEN
  ERROR := ERR_FILE;
END_IF;
```

(\* IL Equivalence: Please refer to the menu of ISaGRAF Projects: Help/language Reference\*)

**Note:** To do the file operation in the \Micro\_SD and \System\_disk of WP-8xx7, WP-5xx7 and VP-2xW7 (or \System\_disk2 and \System\_disk of XP-8xx7-CE6 and XP-8xx7-Atom-CE6) will consume much more CPU time. To do the file operation in RAM Disk, such as in \Temp\, will be better, but it will lost the file after turning off the controller.

## FBUS\_B\_R

- I-8x17/iP-8x17 ■ I-8x37/iP-8x47 ■ I-7188EG/7186EG ■ I-7188XG
- ISaGRAF WinCE PAC

### Description : C\_Function Block

Read a Boolean package from the Fbus device

### Input Parameters :

**PACK\_** Integer Which package No. to read (1 ~ 128)

### Return :

**B1\_ ~ B8\_** Boolean The 8 Boolean values contained in the package

**Example:** Please refer to Chapter 7 or demo\_11a & demo\_11b

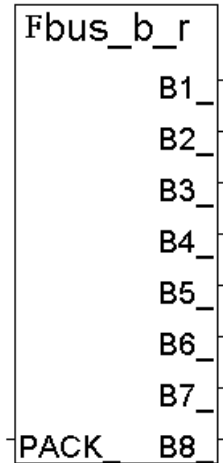

## FBUS\_B\_W

- I-8x17/iP-8x17 ■ I-8x37/iP-8x47 ■ I-7188EG/7186EG ■ I-7188XG
- ISaGRAF WinCE PAC

### Description : C\_Function Block

Write a Boolean package to the Fbus device

### Input Parameters :

**PACK\_** Integer Write which package No., 1 ~ 128

**B1\_ ~ B8\_** Boolean the 8 Boolean values in the package to write

### Return :

**Q\_** Boolean Return TRUE only.

**Example:** Please refer to Chapter 7 or demo\_11a & demo\_11b

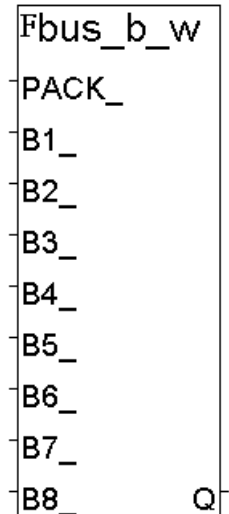

## FBUS\_F\_R

- I-8x17/iP-8x17 ■ I-8x37/iP-8x47 ■ I-7188EG/7186EG ■ I-7188XG
- ISaGRAF WinCE PAC

### Description : C\_Function Block

Read an Real package from the Fbus device

### Input Parameters :

**PACK\_NO\_** Integer Read which package No. 1 ~ 128

### Return :

**F1\_ ~ F8\_** Real The 8 Real values contained in the package  
If error, return 1.23E-20.

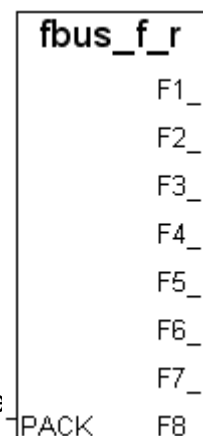

### Important :

1. "FBUS\_F\_R" use the same memory area as "FBUS\_N\_R".
2. Please **DO NOT** use Integer and Real data in the same package number, the data may be error. It may cause: "ERROR 116: FBUS\_F\_R float error".
3. Please use "FBUS\_N\_R" & "FBUS\_N\_W" to transfer Integer value.

**Example:** Please refer to Chapter 7 or demo\_11a & demo\_11b

## FBUS\_F\_W

- I-8x17/iP-8x17 ■ I-8x37/iP-8x47 ■ I-7188EG/7186EG ■ I-7188XG
- ISaGRAF WinCE PAC

### Description : C\_Function Block

Write a Real package to the Fbus device

### Input Parameters :

**PACK\_NO\_** Integer Write which package No., 1 ~ 128

**F1\_ ~ F8\_** Real The 8 Real values in the package to write

### Return :

**Q\_** Boolean Return TRUE only.

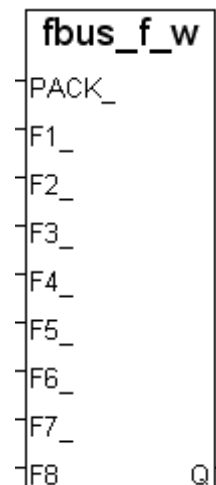

### Important :

1. "FBUS\_F\_W" use the same memory area as "FBUS\_N\_W".
2. Please **DO NOT** use Integer and Real data in the same package number, the data may be error. It may cause: "ERROR 116: FBUS\_F\_R float error".
3. Please use "FBUS\_N\_R" & "FBUS\_N\_W" to transfer Integer value.
4. For using FBUS\_F\_R and FBUS\_F\_W, the driver must be the version listed below or higher version:

I-7188EG : since ver. 2.17

I-7188XG : since ver. 2.15

I-8xx7 : since ver. 3.19

**Example:** Please refer to Chapter 7 or demo\_11a & demo\_11b

## FBUS\_N\_R

- I-8x17/iP-8x17 ■ I-8x37/iP-8x47 ■ I-7188EG/7186EG ■ I-7188XG
- ISaGRAF WinCE PAC

### Description : C\_Function Block

Read an Integer package (signed 32-bit) from the Fbus device

### Input Parameters :

**PACK\_** Integer Read which package No., 1 ~ 128

### Return :

**N1\_ ~ N8\_** Integer The 8 Integer values contained in the package

**Example:** Please refer to Chapter 7 or demo\_11a & demo\_11b

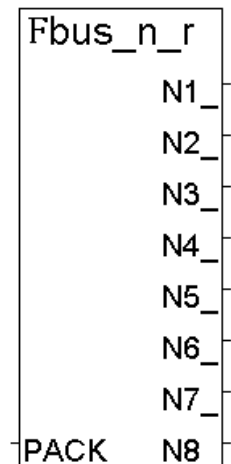

## FBUS\_N\_W

- I-8x17/iP-8x17 ■ I-8x37/iP-8x47 ■ I-7188EG/7186EG ■ I-7188XG
- ISaGRAF WinCE PAC

### Description : C\_Function Block

Write an Integer package (signed 32-bit) to the Fbus device

### Input Parameters :

**PACK\_** Integer Write which package No., 1 ~ 128

**N1\_ ~ N8\_** Boolean The 8 Integer values contained in the package

### Return :

**Q\_** Boolean Return TRUE always.

**Example:** Please refer to Chapter 7 or demo\_11a & demo\_11b

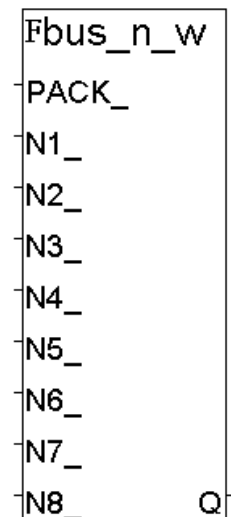

## FBUS\_STS

- I-8x17/iP-8x17 ■ I-8x37/iP-8x47 ■ I-7188EG/7186EG ■ I-7188XG
- ISaGRAF WinCE PAC

### Description : C\_Function Block

Get package status of Fbus

### Input Parameters :

**ID\_** Integer What to get? 0: Boolean package, 1: Integer package

**PACK\_** Integer Which package No. to get? (1-128)

### Return :

**Q\_** Boolean TRUE: package is alive; FALSE: package is dead.  
The reasons may cause package dead:  
Fbus\_m controller didn't enable the package number,  
communication break, the controller for sending that package is  
dead, Fbus\_m controller is dead, or other...

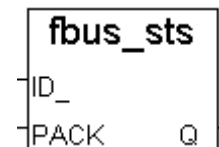



## FM\_READ

- I-8x17/iP-8x17 □ I-8x37/iP-8x47 □ I-7188EG/7186EG □ I-7188XG
- ISaGRAF WinCE PAC

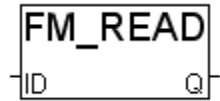

### Description : Standard\_Function

Read Message variables from a Binary file.

### Input Parameters :

**ID** Integer File ID No. (returned by F\_ROPEN, F\_WOPEN or F\_CREAT)

### Return :

**Q** Message The returned message

### Example :

```
(* ST Program: *)
file_id := F_ROPEN('\Micro_SD\m1.txt');
status1 := FM_READ(file_id);
ok := F_CLOSE(file_id);
```

```
(* IL Equivalence: *)
LD      '\Micro_SD\m1.txt'
F_ROPEN
ST      file_id
FM_READ      (* read status1 *)
ST      status1
LD      file_id
F_CLOSE
ST      ok
```

**Note:** To do the file operation in the \Micro\_SD and \System\_disk of WP-8xx7, WP-5xx7 and VP-2xW7 (or \System\_disk2 and \System\_disk of XP-8xx7-CE6 and XP-8xx7-Atom-CE6) will consume much more CPU time. To do the file operation in RAM Disk, such as in \Temp\, will be better, but it will lost the file after turning off the controller.

## FM\_WRITE

- I-8x17/iP-8x17 □ I-8x37/iP-8x47 □ I-7188EG/7186EG □ I-7188XG
- ISaGRAF WinCE PAC

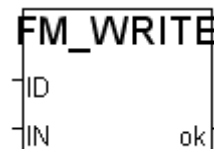

### Description : Standard\_Function

Write Message into a Binary file.

### Input Parameters :

<b>ID</b>	Integer	File ID No. (returned by F_ROPEN, F_WOPEN or F_CREAT)
<b>IN</b>	Message	The message to be write into the file

### Return :

<b>OK</b>	Boolean	Execution status. TRUE: ok.
-----------	---------	-----------------------------

### Example :

(\* ST Program: \*)

```
file_id := F_WOPEN('\Micro_SD\m1.txt ');  
ok := FM_WRITE(file_id,'First message');  
ok := FM_WRITE(file_id,'Last message');  
ok := F_CLOSE(file_id);
```

(\* IL Eauivalence: \*)

```
LD 'trace.txt'  
F_WOPEN  
ST file_id  
FM_WRITE 'First message'          (* write the first message *)  
ST ok  
LD file_id  
FM_WRITE 'Last message'          (*write the second message *)  
ST ok  
LD file_id  
F_CLOSE  
ST ok
```

**Note:** To do the file operation in the \Micro\_SD and \System\_disk of WP-8xx7, WP-5xx7 and VP-2xW7 (or \System\_disk2 and \System\_disk of XP-8xx7-CE6 and XP-8xx7-Atom-CE6) will consume much more CPU time. To do the file operation in RAM Disk, such as in \Temp\, will be better, but it will lost the file after turning off the controller.

## FR\_B

- I-8x17/iP-8x17 □ I-8x37/iP-8x47 □ I-7188EG/7186EG □ I-7188XG
- ISaGRAF WinCE PAC

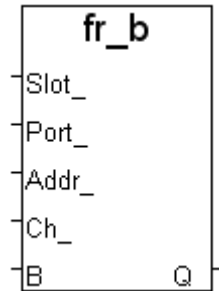

### Description : C\_Function

Set ISaGRAF Boolean variables as an FRNET I/O.

(RECOMMEND TO USE OTHER BETTER FUNCTION-BLOCKS –  
“FR\_16di” and “FR\_16do” , please refer to Chapter 23)

### Input Parameters :

<b>Slot_</b>	Integer	Slot No. that the related i-8172 is plugged in (1-7)
<b>Port_</b>	Integer	Port No. used in the i-8072 ( 0 or 1 )
<b>Addr_</b>	Integer	Module address , D/O ( 0 - 7 ) , D/I ( 8 - 15 )
<b>Ch_</b>	Integer	Channel number been used (1 - 16)
<b>B_</b>	Boolean	Boolean variable name

### Return :

<b>Q_</b>	Boolean	True: Ok. False: parameter error.
-----------	---------	-----------------------------------

### Note :

1. Please connect i-8172 in Wincon's slot 1 to 7, and then connecting FRNET I/O modules from its Port0 or Port1.
2. Fr\_B & Fr\_B\_A should be called in the first PLC scan. They don't work in the 2nd or other PLC scan.
3. FRNET D/O module doesn't support communication state detection. However FRNET D/I module support it.
4. Every FRNET Output module has a 'RESET' dip on its Dip switch or a special Jumper. User may set it to 'ON' position (or enable it), this will reset the output channels to OFF state when the communication is break between i-8172 and FRNET D/O module.  
For example, set 8th Dip to ON of FR-2057 means enable it.
5. You may visit below web site for more information:  
<http://www.icpdas.com/faq/isagraf.htm> 'FAQ048' &  
[http://www.icpdas.com/products/Remote\\_IO/frnet/frnet\\_list.htm](http://www.icpdas.com/products/Remote_IO/frnet/frnet_list.htm)

**Example :** Please refer to 'FAQ082' at <http://www.icpdas.com/faq/isagraf.htm> , and the Example file: Wdemo\_70.

## Fr\_B\_A

- I-8xx7   ■ iPAC-8447/8847   □ I-7188EG/7186EG   □ I-7188XG
- ISaGRAF WinCE PAC

### Description : C\_Function

Set ISaGRAF Boolean "variable array" as several FRNet I/O(s)  
(Please refer to Section 2.6 for the information about "Variable array")  
(RECOMMEND TO USE OTHER BETTER FUNCTION-BLOCKS –  
"FR\_16di" and "FR\_16do", please refer to Chapter 23)

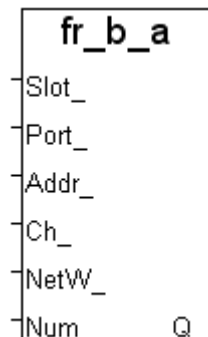

### Input Parameters :

<b>Slot_</b>	Integer	Slot No. that the related i-8172 is plugged in (1~7)
<b>Port_</b>	Integer	Port No. used in the i-8072 ( 0 or 1 )
<b>Addr_</b>	Integer	Starting module address, D/O (0~7), D/I (8~15)
<b>Ch_</b>	Integer	Starting Channel number (1~16)
<b>NetW_</b>	Integer	Network address No. for the 1st element of the related "Variable Array": 1~8191
<b>Num_</b>	Integer	Amount of Boolean in the "Variable Array" to set as FRNet IOs. Valid range: 1~255. Ex: Bi[0..15] has size of 16, You may set NUM_ as 1 to 16. ABC[0..127] has size of 128, you may set NUM_ as 1 to 128.

### Return :

**Q\_**      Boolean    True: Ok.    False: parameter error.

### Note :

1. Please connect i-8172 in Wincon's slot 1 to 7, and then connecting FRNET I/O modules from its Port0 or Port1.
2. Fr\_B , Fr\_B\_A should be called in the first PLC scan. They don't work in the 2nd or other PLC scan.
3. FRNET D/O module doesn't support communication state detection. However FRNET D/I module support it.
4. Every FRNET Output module has a 'RESET' dip on its Dip switch or a special Jumper. User may set it to 'ON' position (or enable it), this will reset the output channels to OFF state when the communication is break between i-8172 and FRNET D/O module.  
For example, set 8th Dip to ON of FR-2057 means enable it.
5. To declare a "Variable Array" for ISaGRAF version 3.4 (or 3.5), please edit the "isa.ini" file in the ISaGRAF sub-directory "C:\ISAWIN\EXE\". And then when you open the ISaGRAF workbench, there will be a "DIM" area in the Dictionary Declaration Windows for you to assign the size of the "variable array".  
Edit c:\isawin\exe\isa.ini file, add these 2 lines at the beginning of the file content:  
[DEBUG]  
arrays=1
6. You may visit below web site for more information:  
<http://www.icpdas.com/faq/isagraf.htm> 'FAQ082' &  
[http://www.icpdas.com/products/Remote\\_IO/frnet/frnet\\_list.htm](http://www.icpdas.com/products/Remote_IO/frnet/frnet_list.htm)

**Example :** Please refer to 'FAQ082' at <http://www.icpdas.com/faq/isagraf.htm> , and the Example file: Wdemo\_70.

## GET\_INFO

■ I-8x17/iP-8x17 ■ I-8x37/iP-8x47 ■ I-7188EG/7186EG ■ I-7188XG ■ ISaGRAF WinCE PAC

### Description : C\_Function

Get the controller information.



### Input Parameters :

**TYPE\_** Integer      What information to get?

### Return :

**DATA\_** Integer      Returned information value.

**Table :** The following is the meaning of "TYPE\_" V.S. "DATA\_"

TYPE_		DATA_
1	Get the controller ID (slave No.)	1 - 255
2	reserved for the future	0
3	reserved for the future	0
4	reserved for the future	0

## GET\_SN

■ I-8x17/iP-8x17 ■ I-8x37/iP-8x47 ■ I-7188EG/7186EG ■ I-7188XG ■ ISaGRAF WinCE PAC

### Description : C\_Function Block

Get hardware unique serial No. Total is 8 Integer.

### Return :

**SN\_1\_~SN\_8\_** Integer      The returned serial No.  
8 bytes (-128 to +127)

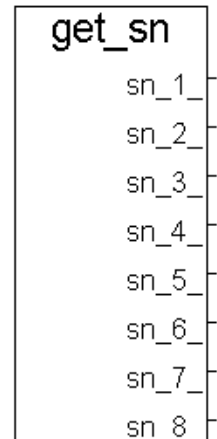

## GET\_VER

- I-8x17/iP-8x17 ■ I-8x37/iP-8x47 ■ I-7188EG/7186EG ■ I-7188XG
- ISaGRAF WinCE PAC

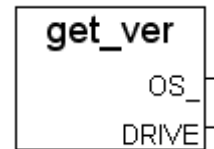

### Description : C\_Function Block

Get the version information of hardware driver

(Used for I-8xx7: v2.19, I-7188EG: v1.10, I-7188XG: v1.08 or higher version)

### Return :

<b>OS_</b>	Message	The OS version should be updated (length: 48) Ex: "Must use 8n020704.img"
<b>DRIVER_</b>	message	The current Driver version (length: 48) Ex: "I-8xx7 : isa.exe - 2.19 , Dec.09,2002"

## GETCTS

- I-8x17/iP-8x17 □ I-8x37/iP-8x47 ■ I-7188EG/7186EG ■ I-7188XG
- ISaGRAF WinCE PAC



### Description : C\_Function Block

Get CTS state of a COM port.

### Input Parameters :

<b>PORT_</b>	Integer	3:COM3, 4:COM4, 5:COM5
--------------	---------	------------------------

### Return :

<b>Q_</b>	Boolean	TRUE: enable, FALSE: disable.
-----------	---------	-------------------------------

## I\_DICNT

■ I-8x17/iP-8x17 ■ I-8x37/iP-8x47 ■ I-7188EG/7186EG ■ I-7188XG ■ ISaGRAF WinCE PAC

### Description : C\_Function Block

Get the 4 DI Counters of extension DI modules link with COM3/4 of the I-8xx7 controller or COM2 of the I-7188XG/EG controller or COM3 of the W-8xx7 controller.

### Input Parameters :

<b>ADR_</b>	Integer	The address of the I/O module(1~255), must be a constant value, not a variable.
<b>ST_CN_</b>	Integer	Starting Channel number (1~13), must be a constant value, not a variable. Ex: The I-87052 has 8 DI. If ST_CN_ set as 5, CN1_ get the Ch.5' counter value. CN2_ get Ch.6's, CN3_ get Ch.7's, CN4_ get Ch.8's value.
<b>RS1_ ~ RS4_</b>	Boolean	Reset the associated D/I counter when rising from False to True.

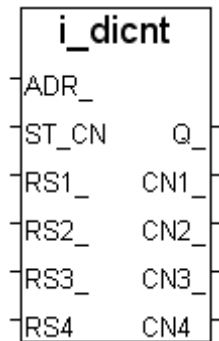

### Return :

<b>Q_</b>	Boolean	TRUE: work ok, FALSE: fail. "If Q_ is FALSE, it means communication is bad, the following return value has no meaning"
<b>CN1_ ~ CN4_</b>	Integer	The DI Counter value of channel No. starting from ST_CN_.

### \*\*The modules listed below have DI counters (Max to 100 Hz) :

"I\_DICNT" support: i-87051 , 87052 , 87053 , 87054 , 87055 , 87058 , 87063  
i-7041, 7044, 7050 , 7051, 7052 , 7053 , 7055, 7058, 7060 , 7063 , 7065

"I\_DICNT2" support: i-87040

Counter input channels: 4, valid value: 0 ~ 65535 (Max to 100 Hz)

Reset Counter channels: 4, Reset the D/I counter to 0 when rising from False to True.

### Note :

- I-DiCnt function block valid for version: I-8xx7:2.18 , I-7188EG:1.10 , I-7188XG:1.08 , W-8x37:3.20C or higher version.
- For remote I-87040 module (32 D/I) please use "i\_DiCnt2" function block.

### VERY IMPORTANT:

If the I-87018/87019 is used as a RS-485 Remote I/O, please operate the following steps before connecting them.

- At I/O module side, please use "DCON Utility" to setup:
  - Set "address" to a unique No. (1~255)
  - Set proper "checksum disabled" or "checksum enabled" and set Analog Input module to be "2's complement".
  - Set communication parameter to "baud rate" and "8, N, 1"
  - Set "Range Type" if using Analog board
- At I-8xx7/I-7188EG/I-7188XG side:
  - Connect I/O complex equipment "bus7000B" and set its "baud rate" and "Checksum" equal to the "baud rate" & "Checksum" setting of the I/O modules.
  - I-8xx7 & 7188EG/XG can connect up to 64 remote I/O modules, W-8xx7 can up to 255.
  - Please use i\_7xxx function block or i\_87xxx Function Block when programming RS-485 Remote I/O module.

## I\_DICNT2

■ I-8x17/iP-8x17 ■ I-8x37/iP-8x47 ■ I-7188EG/7186EG ■ I-7188XG ■ ISaGRAF WinCE PAC

### Description : C\_Function Block

Get the 4 DI Counters of extension DI modules link with COM3/4 of the I-8xx7 controller or COM2 of the I-7188XG/EG controller or COM3 of the W-8xx7 controller.

### Input Parameters:

<b>ADR_</b>	Integer	The address of the I-8740 module(1~255), must be a constant value, not a variable.
<b>ST_CN_</b>	Integer	Starting Channel number (1~29), must be a constant value, not a variable. Ex: The I-87040 has 32 DI. If ST_CN_ set as 15, CN1_ get the Ch.15' counter value. CN2_ get Ch.16's, CN3_ get Ch.17's, CN4_ get Ch.18's value.
<b>RS1_~RS4_</b>	Boolean	Reset the associated D/I counter when rising from False to True.

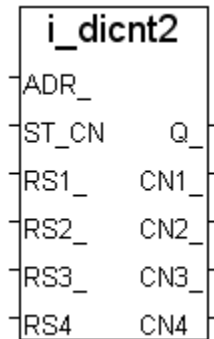

### Return :

<b>Q_</b>	Boolean	TRUE: work ok, FALSE: fail. "If Q_ is FALSE, it means communication is bad, the following return value has no meaning"
<b>CN1_~CN4_</b>	Integer	The DI Counter value of channel No. starting from ST_CN_.

### \*\*The modules listed below have DI counters (Max to 100 Hz) :

"I\_DICNT" support: i-87051 , 87052 , 87053 , 87054 , 87055 , 87058 , 87063  
i-7041, 7044, 7050 , 7051, 7052 , 7053 , 7055, 7058, 7060 , 7063 , 7065

"I\_DICNT2" support: i-87040

Counter input channels: 4, valid value: 0 ~ 65535 (Max to 100 Hz)

Reset Counter channels: 4, Reset the D/I counter to 0 when rising from False to True.

### Note :

1. I-DiCnt function block valid for version: I-8xx7:2.18 , I-7188EG:1.10 , I-7188XG:1.08 , W-8x37:3.20C or higher version.
2. For remote I-87040 module (32 D/I) please use "i\_DiCnt2" function block.

### VERY IMPORTANT:

If the I-87018/87019 is used as a RS-485 Remote I/O, please operate the following steps before connecting them.

A. At I/O module side, please use "DCON Utility" to setup:

1. Set "address" to a unique No. (1~255)
2. Set proper "checksum disabled" or "checksum enabled" and set Analog Input module to be "2's complement".
3. Set communication parameter to "baud rate" and "8, N, 1"
4. Set "Range Type" if using Analog board

B. At I-8xx7/I-7188EG/I-7188XG side:

1. Connect I/O complex equipment "bus7000B" and set its "baud rate" and "Checksum" equal to the "baud rate" & "Checksum" setting of the I/O modules.
2. I-8xx7 & 7188EG/XG can connect up to 64 remote I/O modules, W-8xx7 can up to 255.
3. Please use i\_7xxx function block or i\_87xxx Function Block when programming RS-485 Remote I/O module.



## I\_RESET

- I-8x17/iP-8x17 ■ I-8x37/iP-8x47 ■ I-7188EG/7186EG ■ I-7188XG
- ISaGRAF WinCE PAC

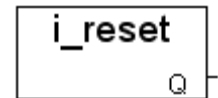

### Description : C\_Function

Reset the controller

### Return :

**Q\_** Boolean The return value has no meaning since the controller will reset

### Note : Please use this function very careful.

1. If the controller is always reset, please refer to section 1.3.7 to delete the project inside the I-8xx7 controller.
2. For I-8417/8817/8437/8837, I-7188EG, I-7188XG:  
**If the controller is reset always**, please refer to Section 1.3.7 of "User's Manual Of The I-8417/8817/8437/8837" for deleting the project inside the controller.
3. For W-8xx7/8xx6 (Wincon ISaGRAF version):  
**If the controller is reset always**, unplug the CF card and restart WinCon power, plug on CF card again, then delete the file - "\Micro\_SD\ISaGRAF\ISA11". After that, restart WinCon controller power again.

### Example :

```
(* OK1 is declared as Boolean input, TMP as Boolean internal *)  
if OK1=TRUE then  
  TMP := i_reset();  
end_if;
```

## I7000\_EN

- I-8x17/iP-8x17 ■ I-8x37/iP-8x47 ■ I-7188EG/7186EG ■ I-7188XG
- ISaGRAF WinCE PAC

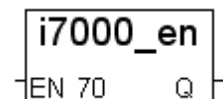

### Description : C\_Function

Enable / Disable "Bus7000"

### Input Parameters :

**EN\_7000\_** Boolean TRUE: enable, FALSE: disable

### Return :

**Q\_** Boolean always return TRUE.

### Note :

1. Default status is "Enable".
2. Only work when I/O complex equipment - "Bus7000" or "Bus7000B" is connected.

## I8KE\_B

- I-8x17/iP-8x17 □ I-8x37/iP-8x47 □ I-7188EG/7186EG □ I-7188XG
- ISaGRAF WinCE PAC

### Description : C\_Function

Set ISaGRAF Boolean variable as an I-8KE4/8-MTCP Ethernet I/O

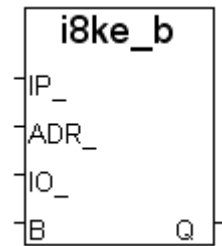

### Input Parameters :

<b>IP_</b>	Message	IP address of the related I-8KE4/8-MTCP, Ex: '192.168.100.123'
<b>ADR_</b>	Integer	Modbus address of i-8KE4/8-MTCP DI/DO, 0~267.
<b>IO_</b>	Boolean	True: input, False: output
<b>B_</b>	Boolean	The Boolean variable name

### Return :

**Q\_** : Boolean      True: Ok.      False: parameter error.

### Note :

1. For detail information, please refer to Chapter 22 or <http://www.icpdas.com/faq/isagraf.htm> 'FAQ042' and [http://www.icpdas.com/products/PAC/i-8000/i-8KE4\\_8KE8\\_MTCP.htm](http://www.icpdas.com/products/PAC/i-8000/i-8KE4_8KE8_MTCP.htm)
2. i-8KE\_B , i8KE\_N , i8KE\_F , i-8KE\_B\_A , i8KE\_N\_A , i-8KE\_F\_A should be called in the first PLC scan. They don't work in the 2nd & other PLC scan.

**Demo Program:** Wdemo\_30 & Wdemo\_31 at <http://www.icpdas.com/faq/isagraf.htm> 'FAQ042'

## I8KE\_B\_A

- I-8x17/iP-8x17 □ I-8x37/iP-8x47 □ I-7188EG/7186EG □ I-7188XG
- ISaGRAF WinCE PAC

### Description : C\_Function

Set ISaGRAF Boolean 'Variable Array' as several i-8KE4/8-MTCP Ethernet I/O(s)  
(Please refer to Section 2.6: Variable Array)

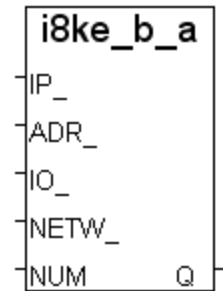

### Input Parameters :

<b>IP_</b>	Message	IP address of the related i-8KE4/8-MTCP, Ex: '192.168.100.123'
<b>ADR_</b>	Integer	Modbus address of i-8KE4/8-MTCP DI/DO, 0~267
<b>IO_</b>	Boolean	True: input, False: output
<b>NetW_</b>	Integer	Network address No. for the 1st element of "Variable Array". 1~8191
<b>Num_</b>	Integer	Amount of Boolean in the "Variable Array" to set as Ethernet IO Valid range: 1~255. ( ADR_ + Num_ ) cannot be larger than 264. Ex: Bi[0..15] has size of 16, NUM_ could be (1 ~ 16). ABC[0..7] has size of 8, NUM_ could be (1 ~ 8).

### Return :

<b>Q_</b>	Boolean	True: Ok. False: parameter error.
-----------	---------	-----------------------------------

### Note :

- For detail information, please refer to Chapter 22 or <http://www.icpdas.com/faq/isagraf.htm> 'FAQ042' & [http://www.icpdas.com/products/PAC/i-8000/i-8KE4\\_8KE8\\_MTCP.htm](http://www.icpdas.com/products/PAC/i-8000/i-8KE4_8KE8_MTCP.htm)
- i8KE\_B , i8KE\_N , i8KE\_F , i8KE\_B\_A , i8KE\_N\_A , i8KE\_F\_A should be called in the first PLC scan. They don't work in the 2nd & other PLC scan.
- To declare a "Variable Array" for ISaGRAF version 3.4 (or 3.5), please edit the "isa.ini" file in the ISaGRAF sub-directory "C:\ISAWIN\EXE\". And then when you open the ISaGRAF workbench, there will be a "DIM" area in the Dictionary Declaration Windows for you to assign the size of the "variable array".  
Edit c:\isawin\exe\isa.ini file, add these 2 lines at the beginning of the file content:  
[DEBUG]  
arrays=1

### Demo Program: Wdemo\_30 & Wdemo\_31

Please refer to <http://www.icpdas.com/faq/isagraf.htm> 'FAQ042'

## I8KE\_F

- I-8x17/iP-8x17 □ I-8x37/iP-8x47 □ I-7188EG/7186EG □ I-7188XG
- ISaGRAF WinCE PAC

### Description : C\_Function

Set ISaGRAF REAL variable as an I-8KE4/8-MTCP Ethernet I/O, and scaling to Real type

### Input Parameters :

- IP\_** Message IP address of the related I-8KE4/8-MTCP, Ex: '192.168.100.123'
- ADR\_** Integer Modbus address of I-8KE4/8-MTCP AI/AO: 0~127
- IO\_** Boolean True: input , False: output
- F\_** REAL REAL variable name

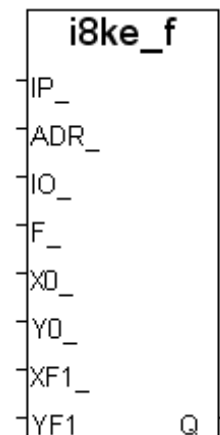

----- For scaling, if no scaling, please set below parameters as ( 0 , 0 , 0.0 , 0.0 ) -----

- X0\_** Integer original value of the analog Input/Output board. X0\_ **DO NOT equal to** Y0\_. Valid range:  $-32768 \leq X0_ \leq +32767$
- Y0\_** Integer Original value of the analog Input/Output board. X0\_ **DO NOT equal to** Y0\_. Valid range:  $-32768 \leq Y0_ \leq +32767$
- XF1\_** REAL Engineering value after scaling, XF1\_ **DO NOT equal to** YF1\_ .
- YF1\_** REAL Engineering value after scaling, XF1\_ **DO NOT equal to** YF1\_ .

### Return :

- Q\_** Boolean True: Ok. False: parameter error.

### Example :

Ex 1: I-8017h set range\_type as '+/- 10 V' (i-8017h's input value is -32768 to +32767). User may want to scale ( 0 , 10 V) to become engineering value of ( 0 , 1000 Psi). Please set ( X0\_ , Y0\_ ) = ( 0 , +32767 ) , ( XF1\_ , YF1\_ ) = ( 0.0 , 1000.0 )

Ex 2: I-8024 set range\_type as '0 to 20 mA' (i-8024's output value is 0 to +32767). User may want to scale ( 4 , 20 mA) to become engineering value of ( 0 , 3000 rpm). Please set ( X0\_ , Y0\_ ) = ( 6553 , +32767 ) , ( XF1\_ , YF1\_ ) = ( 0.0 , 3000.0 )

### Note :

- For detail information, please refer to Chapter 22 or <http://www.icpdas.com/faq/isagraf.htm> 'FAQ042' & [http://www.icpdas.com/products/PAC/i-8000/i-8KE4\\_8KE8\\_MTCP.htm](http://www.icpdas.com/products/PAC/i-8000/i-8KE4_8KE8_MTCP.htm)
- i8KE\_B , i8KE\_N , i8KE\_F , i8KE\_B\_A , i8KE\_N\_A , i8KE\_F\_A should be called in the first PLC scan. They don't work in the 2nd & other PLC scan.

### Demo Program: Wdemo\_30 & Wdemo\_31

Please refer to <http://www.icpdas.com/faq/isagraf.htm> 'FAQ042'

## I8KE\_F\_A

- I-8x17/iP-8x17 □ I-8x37/iP-8x47 □ I-7188EG/7186EG □ I-7188XG
- ISaGRAF WinCE PAC

### Description : C\_Function

Set ISaGRAF REAL 'Variable Array' as several i-8KE4/8-MTCP Ethernet I/O(s), and scaling to Real type (Please refer to Section: 2.6: 'Variable Array')

### Input Parameters :

- IP\_** Message IP address of the related I-8KE4/8-MTCP,  
Ex: '192.168.100.123'
- ADR\_** Integer Modbus address of I-8KE4/8-MTCP AI/AO: 0~127
- IO\_** Boolean True: input , False: output
- NetW\_** Integer Network address No. for the 1st element of "Variable Array".  
1~8191
- Num\_** Integer Amount of Real in the "Variable Array" to set as Ethernet IO  
Valid range: 1~255. ( ADR\_ + Num\_ ) cannot be larger than 128.  
Ex: R1[0..31] has size of 32, NUM\_ could be (1 ~ 32).  
R3[0..7] has size of 8, NUM\_ could be (1 ~ 8).

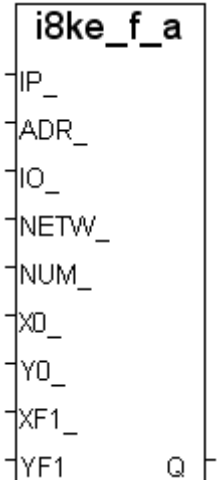

----- For scaling, if no scaling, please set below parameters as ( 0 , 0 , 0.0 , 0.0 ) -----

- X0\_** Integer original value of the analog Input/Output board. X0\_ **DO NOT equal to** Y0\_.  
Valid range: -32768 <= X0\_ <= +32767
- Y0\_** Integer original value of the analog Input/Output board. X0\_ **DO NOT equal to** Y0\_.  
Valid range: -32768 <= Y0\_ <= +32767
- XF1\_** REAL Engineering value after scaling, XF1\_ **DO NOT equal to** YF1\_ .
- YF1\_** REAL Engineering value after scaling, XF1\_ **DO NOT equal to** YF1\_ .

### Return :

- Q\_** Boolean True: Ok. False: parameter error.

### Example :

Ex : I-87024 set range\_type as '4 to 20 mA' (i-87024's output value is 0 to +32767). User may want to scale ( 4 , 20 mA) to become engineering value of ( 0 , 5000 rpm ). Please set ( X0\_ , Y0\_ ) = ( 0 , +32767 ) , ( XF1\_ , YF1\_ ) = ( 0.0 , 5000.0 )

### Note :

- For detail information, please refer to Chapter 22 or <http://www.icpdas.com/faq/isagraf.htm> 'FAQ042' & [http://www.icpdas.com/products/PAC/i-8000/i-8KE4\\_8KE8\\_MTCP.htm](http://www.icpdas.com/products/PAC/i-8000/i-8KE4_8KE8_MTCP.htm)
- i8KE\_B , i8KE\_N , i8KE\_F , i8KE\_B\_A , i8KE\_N\_A , i8KE\_F\_A should be called in the first PLC scan. They don't work in the 2nd & other PLC scan.
- To declare a "Variable Array" for ISaGRAF version 3.4 (or 3.5), please edit the "isa.ini" file in the ISaGRAF sub-directory "C:\ISAWIN\EXE\". And then when you open the ISaGRAF workbench, there will be a "DIM" area in the Dictionary Declaration Windows for you to assign the size of the "variable array".  
Edit c:\isawin\exe\isa.ini file, add these 2 lines at the beginning of the file content:

```
[DEBUG]
arrays=1
```

### Demo Program: Wdemo\_30 & Wdemo\_31.

Please refer to <http://www.icpdas.com/faq/isagraf.htm> 'FAQ042'

## I8KE\_N

- I-8x17/iP-8x17 □ I-8x37/iP-8x47 □ I-7188EG/7186EG □ I-7188XG
- ISaGRAF WinCE PAC

### Description : C\_Function

Set ISaGRAF Integer 'Variable Array' as an I-8KE4/8-MTCP Ethernet I/O(s) and scaling to Integer type.

### Input Parameters :

- IP\_** Message IP address of the related I-8KE4/8-MTCP, Ex: '192.168.100.123'
- ADR\_** Integer Modbus address of I-8KE4/8-MTCP AI/AO: 0~127
- IO\_** Boolean True: input , False: output
- F\_** REAL REAL variable name

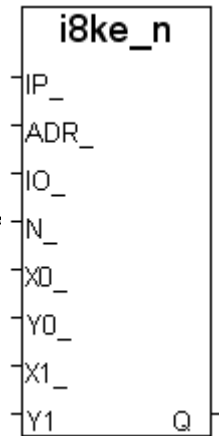

----- For scaling, if no scaling, please set below parameters as ( 0 , 0 , 0.0 , 0.0 ) -----

- X0\_** Integer original value of the analog Input/Output board. X0\_ **DO NOT equal to** Y0\_. Valid range:  $-32768 \leq X0_ \leq +32767$
- Y0\_** Integer original value of the analog Input/Output board. X0\_ **DO NOT equal to** Y0\_. Valid range:  $-32768 \leq Y0_ \leq +32767$
- X1\_** Integer Engineering value after scaling. X1\_ **DO NOT equal to** Y1\_. Valid range:  $-30000 \leq X1_ \leq +30000$
- Y1\_** Integer Engineering value after scaling. X1\_ **DO NOT equal to** Y1\_. Valid range:  $-30000 \leq Y1_ \leq +30000$

### Return :

- Q\_** Boolean True: Ok. False: parameter error.

### Example :

- Ex 1: i-8017h set range\_type as '+/- 10 V' (i-8017h's input value is -32768 to +32767). User may want to scale ( 0 , 10 V) to become engineering value of ( 0 , 1000 Psi). Please set ( X0\_ , Y0\_ ) = ( 0 , +32767 ) , ( X1\_ , Y1\_ ) = ( 0 , 1000 )
- Ex 2: i-8024 set range\_type as '0 to 20 mA' (i-8024's output value is 0 to +32767). User may want to scale ( 4 , 20 mA) to become engineering value of ( 0 , 3000 rpm). Please set ( X0\_ , Y0\_ ) = ( 6553 , +32767 ) , ( X1\_ , Y1\_ ) = ( 0 , 3000 )

### Note :

1. For detail information, please refer to Chapter 22 or:  
<http://www.icpdas.com/faq/isagraf.htm> 'FAQ042' &  
[http://www.icpdas.com/products/PAC/i-8000/i-8KE4\\_8KE8\\_MTCP.htm](http://www.icpdas.com/products/PAC/i-8000/i-8KE4_8KE8_MTCP.htm)
2. i8KE\_B , i8KE\_N , i8KE\_F , i8KE\_B\_A , i8KE\_N\_A , i8KE\_F\_A should be called in the first PLC scan. They don't work in the 2nd & other PLC scan.

**Demo Program:** Wdemo\_30 & Wdemo\_31.

Please refer to <http://www.icpdas.com/faq/isagraf.htm> 'FAQ042'

## I8KE\_N\_A

- I-8x17/iP-8x17 □ I-8x37/iP-8x47 □ I-7188EG/7186EG □ I-7188XG
- ISaGRAF WinCE PAC

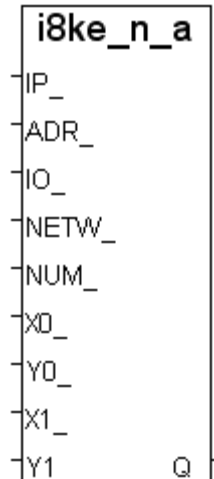

### Description : C\_Function

Set ISaGRAF Integer 'Variable Array' as several i-8KE4/8-MTCP Ethernet I/O(s), and scaling to Integer type.  
(Please refer to Section 2.6: 'Variable Array')

### Input Parameters :

- |              |         |  |
|--------------|---------|--|
| <b>IP_</b>   | Message | IP address of the related I-8KE4/8-MTCP,<br>Ex: '192.168.100.123'  |
| <b>ADR_</b>  | Integer | Modbus address of I-8KE4/8-MTCP AI/AO: 0~127   |
| <b>IO_</b>   | Boolean | True: input , False: output  |
| <b>NetW_</b> | Integer | Network address No. for the 1st element of "Variable Array". 1~8191  |
| <b>Num_</b>  | Integer | Amount of Integer in the "Variable Array" to set as Ethernet IO<br>Valid range: 1~255. ( ADR_ + Num_ ) cannot be larger than 128.<br>Ex: ENG1[0..63] has size of 64, NUM_ could be (1 ~ 64).<br>Ai[0..7] has size of 8, NUM_ could be (1 ~ 8). |

----- For scaling, if no scaling, please set below parameters as ( 0 , 0 , 0.0 , 0.0 ) -----

- |            |         |  |
|------------|---------|--|
| <b>X0_</b> | Integer | original value of the analog Input/Output board. X0_ <b>DO NOT equal to</b> Y0_.<br>Valid range: -32768 <= X0_ <= +32767 |
| <b>Y0_</b> | Integer | original value of the analog Input/Output board. X0_ <b>DO NOT equal to</b> Y0_.<br>Valid range: -32768 <= Y0_ <= +32767 |
| <b>X1_</b> | REAL    | Engineering value after scaling. X1_ <b>DO NOT equal to</b> Y1_ .<br>Valid range: -30000 <= X1_ <= +30000                |
| <b>Y1_</b> | REAL    | Engineering value after scaling. X1_ <b>DO NOT equal to</b> Y1_ .<br>Valid range: -30000 <= Y1_ <= +30000                |

### Return :

**Q\_** Boolean True: Ok. False: parameter error.

### Example :

I-87018R set range\_type as 'Thermo-Couple K-type: -270 to +1372 degree celsius' (i-87018R's input value is -6448 to +32767). User may want to scale ( -270 , +1372 degree) to become engineering value of ( -2700 , +13720 ). Please set ( X0\_ , Y0\_ ) = ( -6448 , +32767 ) , ( X1\_ , Y1\_ ) = ( -2700 , +13720 )

### Note :

- For detail information, please refer to Chapter 22 or <http://www.icpdas.com/faq/isagraf.htm> 'FAQ042' & [http://www.icpdas.com/products/PAC/i-8000/i-8KE4\\_8KE8\\_MTCP.htm](http://www.icpdas.com/products/PAC/i-8000/i-8KE4_8KE8_MTCP.htm)
- i8KE\_B , i8KE\_N , i8KE\_F , i8KE\_B\_A , i8KE\_N\_A , i8KE\_F\_A should be called in the first PLC scan. They don't work in the 2nd & other PLC scan.
- To declare a "Variable Array" for ISaGRAF version 3.4 (or 3.5), please edit the "isa.ini" file in the ISaGRAF sub-directory "C:\ISAWIN\EXE\". And then when you open the ISaGRAF workbench, there will be a "DIM" area in the Dictionary Declaration Windows for you to assign the size of the "variable array".

Edit c:\isawin\exe\isa.ini file, add these 2 lines at the beginning of the file content:

```
[DEBUG]
arrays=1
```

**Demo Program:** Wdemo\_30 & Wdemo\_31.

Please refer to <http://www.icpdas.com/faq/isagraf.htm> 'FAQ042'

## INP10LED

- I-8x17/iP-8x17 ■ I-8x37/iP-8x47 □ I-7188EG/7186EG □ I-7188XG
- ISaGRAF WinCE PAC

### Description : C\_Function

Input a decimal Integer from the S\_MMI

#### Input Parameters :

<b>RUN_</b>	Boolean	When "TRUE", process & display value to SMMI
<b>VAL_I_</b>	Integer	Initial value displayed on S-MMI (0 ~ 99999)
<b>NUM_</b>	Integer	Number of digits to display (1 ~ 5)
<b>U1_</b>	Boolean	When it rising from "false" to "true", add 1 to current displayed digit.
<b>D1_</b>	Boolean	When it rising from "false" to "true", subtract 1 from current displayed digit.
<b>L1_</b>	Boolean	When it rising from "false" to "true", shift left 1 position from current displayed digit
<b>R1_</b>	Boolean	When it rising from "false" to "true", shift right 1 position from current displayed digit

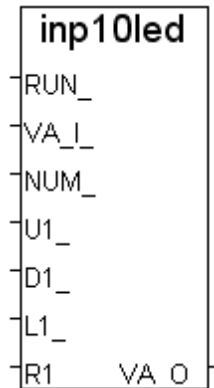

#### Return :

**VAL\_O\_** Integer The displayed Integer value after operation

**Example:** Please refer to demo\_08 & demo\_11a.

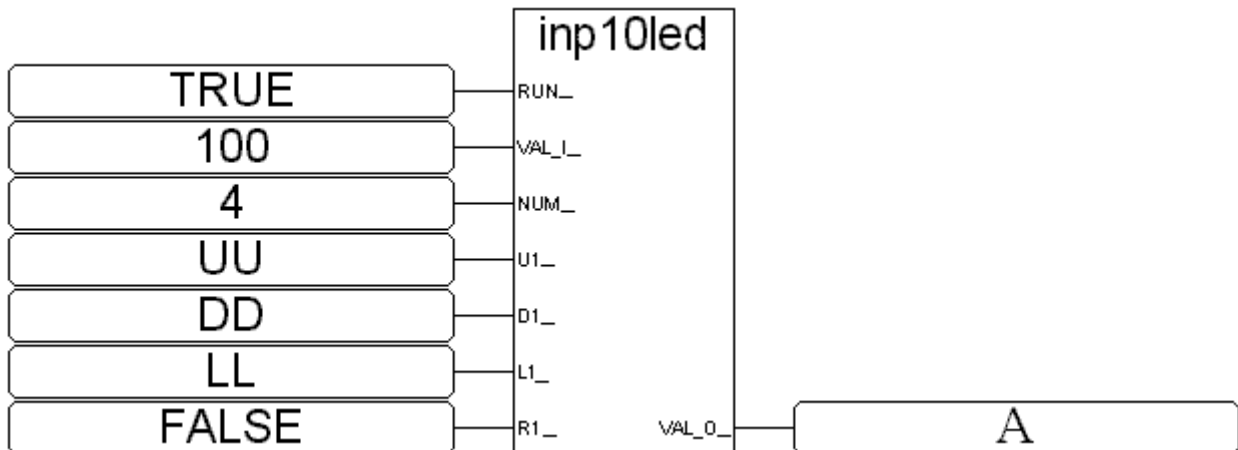

#### ST Equivalence:

```
A := INP10LED(TRUE,100,4,UU,DD,LL,FALSE);
```

(\* A is declared as an integer variable \*)

(\* UU,DD,LL are declared as input boolean variables, can be linked to "push4key" board \*)



## INP16LED

- I-8x17/iP-8x17 ■ I-8x37/iP-8x47 □ I-7188EG/7186EG □ I-7188XG
- ISaGRAF WinCE PAC

### Description : C\_Function

Input a hexadecimal Integer from the S\_MMI

### Input Parameters :

<b>RUN_</b>	Boolean	When "TRUE", process & display value to SMMI
<b>VAL_I_</b>	Integer	Initial value displayed on S-MMI (0 ~ 16#FFFFFF)
<b>NUM_</b>	Integer	Number of digits to display (1 ~ 5)
<b>U1_</b>	Boolean	When it rising from "false" to "true", add 1 to current displayed digit.
<b>D1_</b>	Boolean	When it rising from "false" to "true", subtract 1 from current displayed digit.
<b>L1_</b>	Boolean	When it rising from "false" to "true", shift left 1 position from current displayed digit
<b>R1_</b>	Boolean	When it rising from "false" to "true", shift right 1 position from current displayed digit

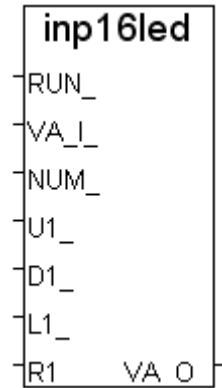

### Return :

**VAL\_O\_** Integer The displayed Integer value after operation

### Example:

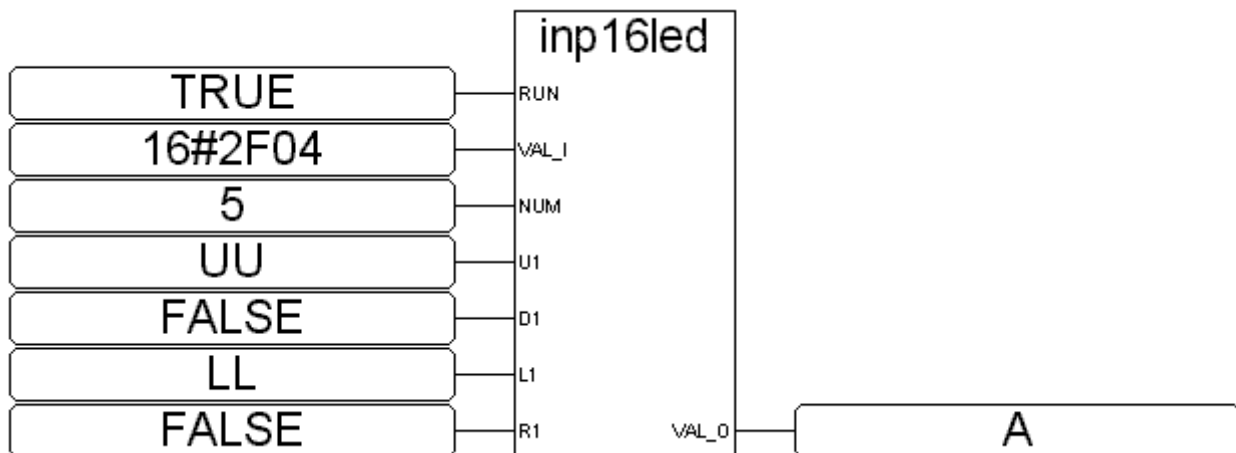

### ST equivalence:

```
A := INP16LED(TRUE,16#2F04,4,UU,FALSE,LL,FALSE);
(* A is declared as an integer variable *)
(* UU,LL are declared as boolean variables,can be linked to "push4key" board *)
```

## INT\_REAL

- I-8x17/iP-8x17 ■ I-8x37/iP-8x47 ■ I-7188EG/7186EG ■ I-7188XG
- ISaGRAF WinCE PAC

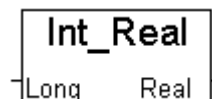

### Description : C\_Function

Map a Long Integer to a Real value.

The algorithm in C language is `Real_ = *((float *)&Long_);`

### Input Parameters :

**Long\_** Integer The 32-bit Integer to map

### Return :

**Real\_** Real The Real value after mapping

### Note:

1. "Real\_Int" can be used to map a Real value to a Long Integer.
2. If you just want to convert one Integer value to Real value, Ex: 32 → 32.0 , please use "REAL()" function.

## VERY IMPORTANT:

The "int\_real(L1)" may cause controller un-stable if the parameter "L1" is not generated by a previous "L1 := real\_int(R1)" command (Refer to **section 10.6**).

## INT\_STR3

- I-8x17/iP-8x17 ■ I-8x37/iP-8x47 ■ I-7188EG/7186EG ■ I-7188XG
- ISaGRAF WinCE PAC

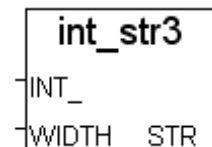

### Description : C\_Function

Convert an Integer value to a String with fixed digit number.

### Input Parameters :

**INT\_** Integer The Integer to be converted.

**WIDTH\_** Integer Max number of digit to show, 1 ~ 13

### Return :

**STR\_** Message The returned String (max. length: 13).

Ex. if **WIDTH\_ = 4**

12 ---> ' 12'

123456 ---> '\*\*\*\*\*'

## LONG\_WD

- I-8x17/iP-8x17 ■ I-8x37/iP-8x47 ■ I-7188EG/7186EG ■ I-7188XG
- ISaGRAF WinCE PAC

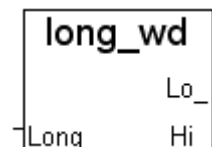

### Description : C\_Function Block

Convert one Long Integer (signed 32-bit) to two Words (signed 16-bit)

### Input Parameters :

**LONG\_** Integer The 32-bit Integer to be converted.

### Return :

**LO\_** Integer The low Word value after the conversion, (-32768 ~ +32767)

**HI\_** Integer The high Word value after the conversion, (-32768 ~ +32767)

## MAIL\_SET

□ I-8xx7 ■ iPAC-8447/8847 □ I-7188EG/XG ■ uPAC-7186EG ■ ISaGRAF WinCE PAC

### Description : C\_Function

Set email receiver , mail server and sender.

Please refer to Chapter 12 and

[www.icpdas.com](http://www.icpdas.com) – FAQ – Software – ISaGRAF – 067 , 071 , 072 , 076 ~ 080

## MAIL\_SND

□ I-8xx7 ■ iPAC-8447/8847 □ I-7188EG/XG ■ uPAC-7186EG ■ ISaGRAF WinCE PAC

### Description : C\_Function

Send an Email via ethernet port.

Please refer to Chapter 12 and

[www.icpdas.com](http://www.icpdas.com) – FAQ – Software – ISaGRAF – 067 , 071 , 072 , 076 ~ 080

## MBUS\_B\_R

■ I-8x17/iP-8x17 ■ I-8x37/iP-8x47 ■ I-7188EG/7186EG ■ I-7188XG  
■ ISaGRAF WinCE PAC

### Description : C\_Function Block

Read 8 bits (Booleans) from the Modbus device

Use the Modbus function code ---- 1

### Input Parameters :

<b>SLAVE_</b>	Integer	Slave No (Net-ID) of the Modbus device. It must be a constant, not a variable Modbus Device ID = remainder of SLAVE_ / 1000 COM port used by ISaGRAF Controller= quotient of SLAVE_ / 1000 I-8xx7 : (1:COM1, 3:COM3, 4:COM4, 5:COM5) I-7188EG/7186EG : (1:COM1, 2:COM2, 3:COM3) I-7188XG : (2:COM2, 3:COM3) W-8xx7/8xx6 : (2:COM2, 3:COM3, 4:COM5 ... 14:COM14) Ex: SLAVE_ = 3001, then use COM3, and the Device ID is 1.
<b>ADDR_</b>	Integer	The starting Modbus address to read (0~65535) It must be a constant, not a variable

### Return :

<b>Q_</b>	Boolean	Ok. return TRUE, else return FALSE
<b>B1_ ~ B8_</b>	Boolean	The 8 Boolean values that have been read

**Note:** The total number of (MBUS\_B\_R + MBUS\_BR1) that can be used in one ISaGRAF project is up to 64 for I-8xx7 or I-7188EG/XG controller.  
For ISaGRAF WinCE PAC, the total number is up to 256 for each COM Port.

**Example:** Please refer to Chapter 8.

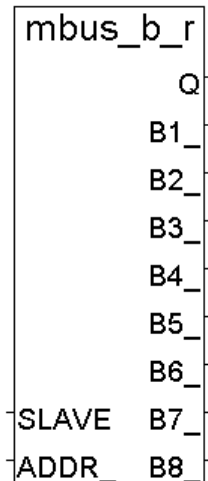

## MBUS\_B\_W

- I-8x17/iP-8x17 ■ I-8x37/iP-8x47 ■ I-7188EG/7186EG ■ I-7188XG
- ISaGRAF WinCE PAC

### Description : C\_Function Block

Write 1 to 4 bits (Booleans) to the Modbus device

Use Modbus function code 5 when NUM\_W = 1

Use Modbus function code 15 when NUM\_W = 2 to 4

### Input Parameters :

<b>SLAVE_</b>	Integer	Slave No (Net-ID) of the Modbus device. It must be a constant, not a variable Modbus Device ID = remainder of SLAVE_ / 1000 COM port used by ISaGRAF Controller= quotient of SLAVE_ / 1000 I-8xx7 : (1:COM1, 3:COM3, 4:COM4, 5:COM5) I-7188EG/7186EG : (1:COM1, 2:COM2, 3:COM3) I-7188XG : (2:COM2, 3:COM3) W-8xx7/8xx6 : (2:COM2, 3:COM3, 4:COM5 ... 14:COM14) Ex: SLAVE_ = 3001, then use COM3, and the Device ID is 1.
<b>ADDR_</b>	Integer	The starting Modbus address to write (0~65535). It must be a constant, not a variable
<b>NUM_W_</b>	Integer	The number of Booleans to write (1 to 4). It must be a constant, not a variable
<b>ACTION_</b>	Boolean	Set true to write, set FALSE to do nothing
<b>B1_ ~ B4_</b>	Boolean	Boolean to write

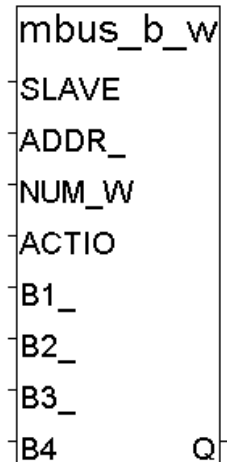

### Return :

<b>Q_</b>	Boolean	Ok, return TRUE, else return FALSE
-----------	---------	------------------------------------

**Note:** The total number of (MBUS\_B\_W) that can be used in one ISaGRAF project is up to 64 for I-8xx7 or I-7188EG/XG controller.  
For ISaGRAF WinCE PAC, the total number is up to 256 for each COM Port.

**Example:** Please refer to Chapter 8.

## MBUS\_BR1

- I-8x17/iP-8x17 ■ I-8x37/iP-8x47 ■ I-7188EG/7186EG ■ I-7188XG
- ISaGRAF WinCE PAC

### Description : C\_Function Block

Read 8 bits (Booleans) from the Modbus device with a period time

Using Modbus function code 1

### Input Parameters :

- |                |         |   |
|----------------|---------|---|
| <b>SLAVE_</b>  | Integer | Slave No (Net-ID) of the Modbus device.<br>It must be a constant, not a variable<br>Modbus Device ID = remainder of SLAVE_ / 1000<br>COM port used by ISaGRAF Controller= quotient of SLAVE_ / 1000<br>I-8xx7 : (1:COM1, 3:COM3, 4:COM4, 5:COM5)<br>I-7188EG/7186EG : (1:COM1, 2:COM2, 3:COM3)<br>I-7188XG : (2:COM2, 3:COM3)<br>W-8xx7/8xx6 : (2:COM2, 3:COM3, 4:COM5 ... 14:COM14)<br>Ex: SLAVE_ = 3001, then use COM3, and the Device ID is 1. |
| <b>ADDR_</b>   | Integer | The starting Modbus address to read (0~65535).<br>It must be a constant, not a variable   |
| <b>PERIOD_</b> | Integer | The period to read (1~600), unit: second  |

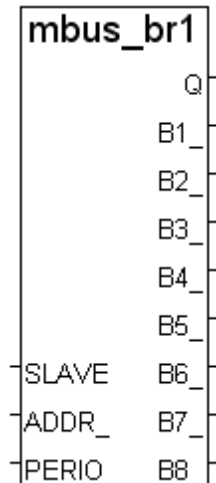

### Return :

- |                |         |  |
|----------------|---------|--|
| <b>Q_</b>      | Boolean | Ok, return TRUE, else return FALSE       |
| <b>B1_~B8_</b> | Boolean | The 8 Boolean values that have been read |

**Note:** The total number of (MBUS\_B\_R + MBUS\_BR1) that can be used in one ISaGRAF project is up to 64 for I-8xx7 or I-7188EG/XG controller.  
For ISaGRAF WinCE PAC, the total number is up to 256 for each COM Port.

## MBUS\_N\_R

- I-8x17/iP-8x17 ■ I-8x37/iP-8x47 ■ I-7188EG/7186EG ■ I-7188XG
- ISaGRAF WinCE PAC

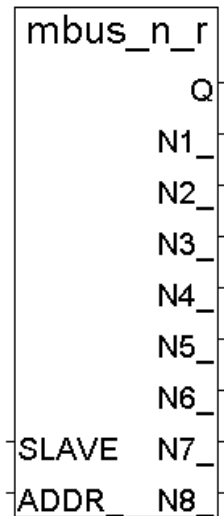

### Description : C\_Function Block

Read 8 Words (signed 16-bit) from the Modbus device

Using Modbus function code 3

### Input Parameters :

**SLAVE\_** Integer Slave No (Net-ID) of the Modbus device.

It must be a constant, not a variable

Modbus Device ID = remainder of SLAVE\_ /

1000

COM port used by ISaGRAF Controller= quotient of SLAVE\_ / 1000

I-8xx7 : (1:COM1, 3:COM3, 4:COM4, 5:COM5)

I-7188EG/7186EG : (1:COM1, 2:COM2, 3:COM3)

I-7188XG : (2:COM2, 3:COM3)

W-8xx7/8xx6 : (2:COM2, 3:COM3, 4:COM5 ... 14:COM14)

Ex: SLAVE\_ = 3001, then use COM3, and the Device ID is 1.

**ADDR\_** Integer The starting Modbus address to read (0~65535).

It must be a constant, not a variable

### Return :

**Q\_** Boolean Ok, return TRUE, else return FALSE

**N1\_ ~ N8\_** Integer The 8 words values that have been read (-32768 ~ 32767)

**Note:** The total number of (MBUS\_N\_R) that can be used in one ISaGRAF project is up to 64 for I-8xx7 or I-7188EG/XG controller.  
For ISaGRAF WinCE PAC, the total number is up to 256 for each COM Port.

**Example:** Please refer to Chapter 8.

## MBUS\_N\_W

■ I-8x17/iP-8x17 ■ I-8x37/iP-8x47 ■ I-7188EG/7186EG ■ I-7188XG ■ ISaGRAF WinCE PAC

### Description : C\_Function Block

Write 1 to 4 Word (signed 16-bit) to the Modbus device

Use Modbus function code 6 when NUM\_W = 1

Use Modbus function code 16 when NUM\_W = 2 to 4

### Input Parameters :

<b>SLAVE_</b> Integer	Slave No (Net-ID) of the Modbus device. It must be a constant, not a variable Modbus Device ID = remainder of SLAVE_ / 1000 COM port used by ISaGRAF Controller= quotient of SLAVE_ / 1000 I-8xx7 : (1:COM1, 3:COM3, 4:COM4, 5:COM5) I-7188EG/7186EG : (1:COM1, 2:COM2, 3:COM3) I-7188XG : (2:COM2, 3:COM3) W-8xx7/8xx6 : (2:COM2, 3:COM3, 4:COM5 ... 14:COM14) Ex: SLAVE_ = 3001, then use COM3, and the Device ID is 1.
<b>ADDR_</b> Integer	The starting Modbus address to write (0~65535). It must be a constant, not a variable
<b>NUM_W_</b> Integer	The number of Words to write (1 to 4). It must be a constant, not a variable
<b>ACTION_</b> Boolean	Set true to write, set FALSE to do nothing
<b>N1_ ~ N4_</b> Integer	words to write(-32768 ~ 32767)

### Return :

**Q\_** Boolean Ok, return TRUE, else return FALS

**Note:** The total number of (MBUS\_N\_W) that can be used in one ISaGRAF project is up to 64 for I-8xx7 or I-7188EG/XG controller.  
For ISaGRAF WinCE PAC, the total number is up to 256 for each COM Port.

**Example:** Please refer to Chapter 8.

**Note:** There is one new "Mbus12w" function block for writing 1 to 12 words. The driver should be the following to support it.

I-7188EG:	(V3.15 or later)
I-7188XG:	(V3.14 or later)
iP-8xx7:	(V1.10 or later)
VP-2117:	(V1.02 or later)
WP-8xx7/8xx6:	(V1.37 or later)
VP-2xW7/2 xW6:	(V1.29 or later)
XP-8xx7-CE6/ XP-8xx6-CE6:	(V1.17 or later)
XP-8xx7-Atom-CE6/ XP-8xx6-Atom -CE6:	(V1.01 or later)
WP-5147/5147-OD:	(V1.01 or later)

## MBUS\_NR1

- I-8x17/iP-8x17 ■ I-8x37/iP-8x47 ■ I-7188EG/7186EG ■ I-7188XG
- ISaGRAF WinCE PAC

### Description : C\_Function Block

Read 8 Words (signed 16-bit) from the Modbus device with a period time

Using Modbus function code 3

### Input Parameters :

- |                |         |   |
|----------------|---------|---|
| <b>SLAVE_</b>  | Integer | Slave No (Net-ID) of the Modbus device.<br>It must be a constant, not a variable<br>Modbus Device ID = remainder of SLAVE_ / 1000<br>COM port used by ISaGRAF Controller= quotient of SLAVE_ / 1000<br>I-8xx7 : (1:COM1, 3:COM3, 4:COM4, 5:COM5)<br>I-7188EG/7186EG : (1:COM1, 2:COM2, 3:COM3)<br>I-7188XG : (2:COM2, 3:COM3)<br>W-8xx7/8xx6 : (2:COM2, 3:COM3, 4:COM5 ... 14:COM14)<br>Ex: SLAVE_ = 3001, then use COM3, and the Device ID is 1. |
| <b>ADDR_</b>   | Integer | The starting Modbus address to read (0~65535).<br>It must be a constant, not a variable   |
| <b>PERIOD_</b> | Integer | The period to read (1~600), unit: second  |

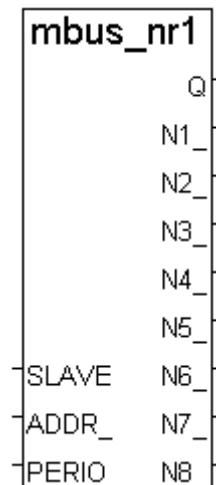

### Return :

- |                  |         |   |
|------------------|---------|---|
| <b>Q_</b>        | Boolean | Ok, return TRUE, else return FALSE                      |
| <b>B1_ ~ B8_</b> | Boolean | The 8 words values that have been read (-32768 ~ 32767) |

**Note:** The total number of (MBUS\_N\_R + MBUS\_NR1 + MBUS\_R + MBUS\_R1) that can be used in one ISaGRAF project is up to 64 for I-8xx7 or I-7188EG/XG controller. For ISaGRAF WinCE PAC, the total number is up to 256 for each COM Port.

**Example:** Please refer to Chapter 8.



## MBUS\_R

- I-8x17/iP-8x17 ■ I-8x37/iP-8x47 ■ I-7188EG/7186EG ■ I-7188XG
- ISaGRAF WinCE PAC

### Description : C\_Function Block

Read data from the Modbus device

- \* Using Modbus function code 1 or 2 or 3 or 4
- \* Please refer to [FAQ-096](#) and [FAQ-101](#) to use Mbus24R, Mbus24R1, Mbus\_XR, Mbus\_XR1 in the ISaGRAF WinCE PAC.

### Input Parameters :

<b>SLAVE_</b>	Integer	Slave No (Net-ID) of the Modbus device. It must be a constant, not a variable Modbus Device ID = remainder of SLAVE_ / 1000 COM port used by ISaGRAF Controller= quotient of SLAVE_ / 1000 I-8xx7 : (1:COM1, 3:COM3, 4:COM4, 5:COM5) I-7188EG/7186EG : (1:COM1, 2:COM2, 3:COM3) I-7188XG : (2:COM2, 3:COM3) W-8xx7/8xx6 : (2:COM2, 3:COM3, 4:COM5 ... 14:COM14) Ex: SLAVE_ = 3001, then use COM3, and the Device ID is 1.
<b>ADDR_</b>	Integer	The starting Modbus address to read (0~65535). It must be a constant, not a variable
<b>CODE_</b>	Integer	The Modbus function code to use, 1 – 4 It must be a constant, not a variable
<b>NUM_</b>	Integer	If CODE_=1 or 2, it's to request how many bits? 1~192 If CODE_=3 or 4, it's to request how many words? 1~12 It must be a constant, not a variable

### Return :

<b>Q_</b>	Boolean	Ok, return TRUE, else return FALSE
<b>N1_~N12_</b>	Integer	The returned Bit or Word <b>If CODE_=1 or 2</b> , N1_ return Bit 1 to 16, N2_ return Bit 17 to 32, ... N12_ return Bit 177 to 192. <b>If CODE_=3 or 4</b> , N1_ to N12_ return Word 1 to 12 (value between -32768 to 32767).

**Note:** The total number of (MBUS\_N\_R + MBUS\_NR1 + MBUS\_R + MBUS\_R1) that can be used in one ISaGRAF project is up to 64 for I-8xx7or I-7188EG/XG controller. For ISaGRAF WinCE PAC, the total number is up to 256 for each COM Port.

**Example:** Please refer to Chapter 8.

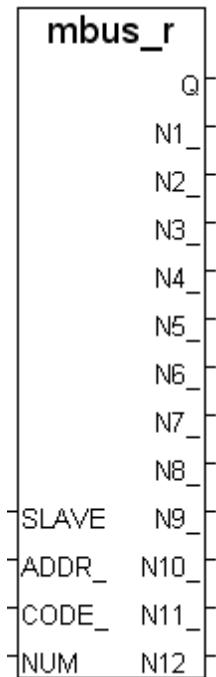

## MBUS\_R1

- I-8x17/iP-8x17 ■ I-8x37/iP-8x47 ■ I-7188EG/7186EG ■ I-7188XG
- ISaGRAF WinCE PAC

### Description : C\_Function Block

Read data from the Modbus device with a period time

- \* Using Modbus function code 1 or 2 or 3 or 4
- \* Please refer to [FAQ-096](#) and [FAQ-101](#) to use Mbus24R, Mbus24R1, Mbus\_XR, Mbus\_XR1 in the ISaGRAF WinCE PAC.

### Input Parameters :

<b>SLAVE_</b>	Integer	Slave No (Net-ID) of the Modbus device. It must be a constant, not a variable Modbus Device ID = remainder of SLAVE_ / 1000 COM port used by ISaGRAF Controller= quotient of SLAVE_ / 1000 I-8xx7 : (1:COM1, 3:COM3, 4:COM4, 5:COM5) I-7188EG/7186EG : (1:COM1, 2:COM2, 3:COM3) I-7188XG : (2:COM2, 3:COM3) W-8xx7/8xx6 : (2:COM2, 3:COM3, 4:COM5 ... 14:COM14) Ex: SLAVE_ = 3001, then use COM3, and the Device ID is 1.
<b>ADDR_</b>	Integer	The starting Modbus address to read (0~65535). It must be a constant, not a variable
<b>CODE_</b>	Integer	The Modbus function code to use, 1~4 It must be a constant, not a variable
<b>NUM_</b>	Integer	If CODE_=1 or 2, it's to request how many bits. 1~192 If CODE_=3 or 4, it's to request how many words. 1~12 It must be a constant, not a variable
<b>PERIOD_</b>	Integer	The period to read (1~600), unit: second.

### Return :

<b>Q_</b>	Boolean	Ok, return TRUE, else return FALSE
<b>N1_ ~ N12_</b>	Integer	the returned bit or word <b>If CODE_ = 1 or 2</b> , N1_ return Bit 1 to 16, N2_ return Bit 17 to 32, ... N12_ return Bit 177 to 192. <b>If CODE_ = 3 or 4</b> , N1_ to N12_ return Word 1 to 12 (value between -32768 to 32767).

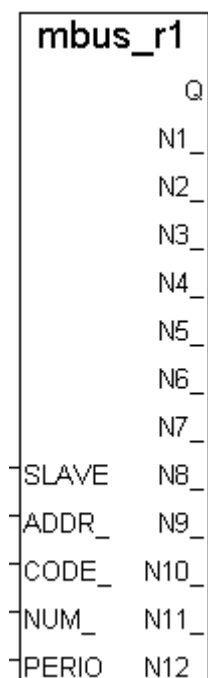

**Note:** The total number of (MBUS\_N\_R + MBUS\_NR1 + MBUS\_R + MBUS\_R1) that can be used in one ISaGRAF project is up to 64 for I-8xx7or I-7188EG/XG controller. For ISaGRAF WinCE PAC, the total number is up to 256 for each COM Port.

**Example:** Please refer to Chapter 8.

## MBUS\_WB

- I-8x17/iP-8x17 ■ I-8x37/iP-8x47 ■ I-7188EG/7186EG ■ I-7188XG
- ISaGRAF WinCE PAC

### Description : C\_Function Block

Write 1~16 Boolean values to Modbus device

Using Modbus function code 15

### Input Parameters :

<b>SLAVE_</b> Integer	Slave No (Net-ID) of the Modbus device. It must be a constant, not a variable Modbus Device ID = remainder of SLAVE_ / 1000 COM port used by ISaGRAF Controller= quotient of SLAVE_ / 1000 I-8xx7 : (1:COM1, 3:COM3, 4:COM4, 5:COM5) I-7188EG/7186EG : (1:COM1, 2:COM2, 3:COM3) I-7188XG : (2:COM2, 3:COM3) W-8xx7/8xx6 : (2:COM2, 3:COM3, 4:COM5 ... 14:COM14) Ex: SLAVE_ = 3001, then use COM3, and the Device ID is 1.
<b>ADDR_</b> Integer	The starting Modbus address to write (0~65535). It must be a constant, not a variable
<b>NUM_W_</b> Integer	The number of Booleans to write (1 ~ 16). It must be a constant, not a variable
<b>ACTION_</b> Boolean	Set true to write, set FALSE to do nothing
<b>B1_~B16_</b> Boolean	Booleans to write (-32768 ~ 32767)

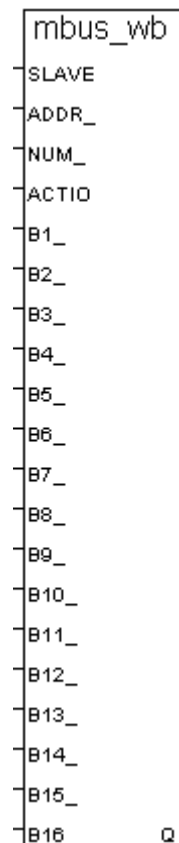

### Return :

<b>Q_</b> Boolean	Ok, return TRUE, else return FALSE
-------------------	------------------------------------

**Note:** The total number of (MBUS\_B\_W + MBUS\_WB) that can be used in one ISaGRAF project is up to 64 for I-8xx7 or I-7188EG/XG controller.  
For ISaGRAF WinCE PAC, the total number is up to 256 for each COM Port.

## MI\_BOO

■ I-8x17/iP-8x17 ■ I-8x37/iP-8x47 ■ I-7188EG/7186EG ■ I-7188XG ■ ISaGRAF WinCE PAC

### Description : C\_Function

Display a Boolean value on MMICON



### Input Parameters :

<b>X_</b>	Integer	X position, 1-30
<b>Y_</b>	Integer	Y position, 1-8
<b>BOO_</b>	Boolean	Boolean value to display. TRUE display "ON", FALSE display "OFF"

### Return :

<b>Q_</b>	Boolean	Ok, return TRUE, else return FALSE
-----------	---------	------------------------------------

**Example:** Please refer to Chapter 16 & demo\_38, demo\_39

## MI\_INP\_N

■ I-8x17/iP-8x17 ■ I-8x37/iP-8x47 ■ I-7188EG/7186EG ■ I-7188XG ■ ISaGRAF WinCE PAC

### Description : C\_Function

Input an Integer value from MMICON

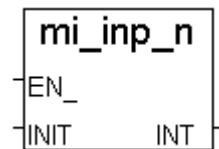

### Input Parameters :

<b>EN_</b>	Boolean	TRUE: enable
<b>INIT_</b>	Integer	Initial value to input

### Return :

<b>INT_</b>	Integer	The Integer value been inputted. If EN_ is FALSE, it returns 0.
-------------	---------	---

### Note :

MI\_INP\_N & MI\_INP\_S can be used only at one place in the project. Called at 2 or more places will work failed.

**Example:** Please refer to Chapter 16 & demo\_38, demo\_39

## MI\_INP\_S

- I-8x17/iP-8x17 ■ I-8x37/iP-8x47 ■ I-7188EG/7186EG ■ I-7188XG
- ISaGRAF WinCE PAC

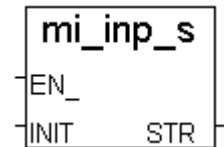

### Description : C\_Function

Input a String from MMICON

### Input Parameters :

<b>EN_</b>	Boolean	TRUE: enable
<b>INIT_</b>	Message	Initial string value to input

### Return :

<b>STR_</b>	Message	The String been inputted. If EN_ is FALSE, it returns "" (empty String)
-------------	---------	---

### Note:

MI\_INP\_N & MI\_INP\_S can be used only at one place in the project. Called at 2 or more places will work failed.

**Example:** Please refer to Chapter 16 & demo\_38, demo\_39

## MI\_INT

- I-8x17/iP-8x17 ■ I-8x37/iP-8x47 ■ I-7188EG/7186EG ■ I-7188XG
- ISaGRAF WinCE PAC

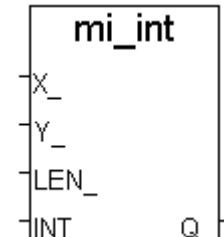

### Description : C\_Function

Display an Integer value on MMICON

### Input Parameters :

<b>X_</b>	Integer	X position, 1-30
<b>Y_</b>	Integer	Y position, 1-8
<b>LEN_</b>	Integer	Max number of digits to display (1~11).
<b>INT_</b>	Integer	Integer value to display. If the length is over LEN_, it display '*****'.

### Return :

<b>Q_</b>	Boolean	Ok, return TRUE, else return FALSE
-----------	---------	------------------------------------

**Example:** Please refer to Chapter 16 & demo\_38, demo\_39

## MI\_REAL

- I-8x17/iP-8x17 ■ I-8x37/iP-8x47 ■ I-7188EG/7186EG ■ I-7188XG
- ISaGRAF WinCE PAC

### Description : C\_Function

Display a Real value on MMICON

#### Input Parameters :

<b>X_</b>	Integer	X position, 1~30
<b>Y_</b>	Integer	Y position, 1~8
<b>LEN_</b>	Integer	Max number of digits to display, 1~13
<b>LEN1_</b>	Integer	Number of digit after '.' (0~4) and less than LEN_.
		Ex. if LEN_=7, LEN1_=2, "123.4567" will be displayed as " 123.45"
<b>REAL_</b>	Real	Real value to display, if the length is over LEN_, it display '*****'.

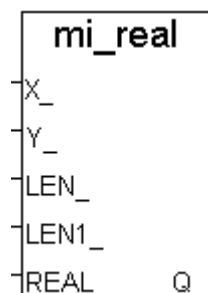

#### Return :

<b>Q_</b>	Boolean	Ok, return TRUE, else return FALSE
-----------	---------	------------------------------------

#### Note:

If abs. of the real value  $\geq 1,000,000$  or (  $> 0$  &  $< 0.0001$  ), please give LEN\_ as 13 to display.  
Ex. -123,456,789, please set LEN\_ to 13 and it is displayed as -1.23457e+008.  
And 0.0000123456, please set LEN\_ to 13 and it is displayed as 1.23456e-005

**Example:** Please refer to Chapter 16 & demo\_38, demo\_39

## MI\_STR

- I-8x17/iP-8x17 ■ I-8x37/iP-8x47 ■ I-7188EG/7186EG ■ I-7188XG
- ISaGRAF WinCE PAC

### Description : C\_Function

Display a String on MMICON

#### Input Parameters :

<b>X_</b>	Integer	X position, 1~30
<b>Y_</b>	Integer	Y position, 1~8
<b>LEN_</b>	Integer	Max number of characters to display, 1~240
<b>STR_</b>	Message	The String to display. If the number of characters exceeds LEN_, only the first LEN_ of char. will be displayed
<b>PASSWD_</b>	Boolean	TRUE: display as password, all char. are replaced as '*'. FALSE: displayed as String.

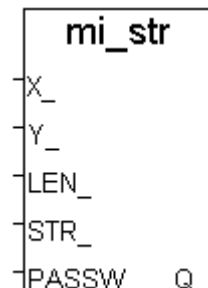

#### Return :

<b>Q_</b>	Boolean	Ok, return TRUE, else return FALSE
-----------	---------	------------------------------------

**Example:** Please refer to Chapter 16 & demo\_38, demo\_39

## MSG\_F

- I-8x17/iP-8x17 ■ I-8x37/iP-8x47 ■ I-7188EG/7186EG ■ I-7188XG
- ISaGRAF WinCE PAC

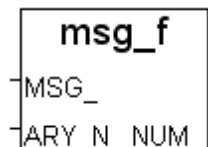

### Description : C\_Function

Extract some Real values (floating point value) from a String (Message).  
These extracted Real values are stored in the Float array.

### Input Parameters :

- |                |         |  |
|----------------|---------|--|
| <b>MSG_</b>    | Message | The Message (String) to be extracted. (The length of a String is 1 to 255 bytes (characters))  |
| <b>ARY_NO_</b> | Integer | The Float array No. to store these extracted Real values.<br>I-8xx7, I-718xEG/XG: 1 ~ 6 (The Float array & Integer array use the same memory. Please use them carefully.)<br>W-8xx7/8xx6: 1 ~ 18 |

### Return :

- |             |         |  |
|-------------|---------|--|
| <b>NUM_</b> | Integer | The total number of Real values been extracted. (0 ~ 128)<br>If returns -1, it means format error. |
|-------------|---------|--|

### Note :

1. The Real value been extracted can be Read / Write by using "ARY\_F\_R" and "ARY\_F\_W" functions
2. The delimiter between Real values in the String should be "SPACE" character or "Comma" or "TAB" or "ENTER" or "NEW LINE" characters.
3. If the related Value in the String is not correct Real format, for example - ' 1.23 , 2.45A , 3.0 , 2+3 ' , the 2nd & 4th value are not correct Real format, this function returns -1.
4. For using MSG\_F and MSG\_N, the driver must be the version listed below or higher version:
  - I-7188EG : since ver. 2.17
  - I-7188XG : since ver. 2.15
  - I-8xx7 : since ver. 3.19
  - W-8xx7 : recommend upgrade to ver. 3.36 or higher version

### Example:

- (1.) If given MSG\_ = '2.3 , -567.002 +0.0025 1 , 1.4E-5' and ARY\_NO\_ = 1 , it will return NUM\_ as 5. The five REAL values are stored in Float array No.1 's address 1 to 5 respectively. addr.1 = 2.3 , addr.2 = -567.002 , addr.3 = 0.0025 , addr.4 = 1.0 , addr.5 = 1.4E-5
- (2.) If given MSG\_ = '4.01 , -8.09 , +-3.45' and ARY\_NO\_ = 2 , it will return NUM\_ as -1. Because the 3rd value +-3.45 is not a correct REAL format

### Demo program:

1. wpdmo\_52.pia at WP-8xx7 CD-ROM:\napdos\isagraf\ wp-8xx7\demo\
2. wpdmo\_52.pia at ftp://ftp.icpdas.com/pub/cd/winpac-8xx7/napdos/isagraf/ wp-8xx7/demo/

## MSG\_N

- I-8x17/iP-8x17 ■ I-8x37/iP-8x47 ■ I-7188EG/7186EG ■ I-7188XG
- ISaGRAF WinCE PAC

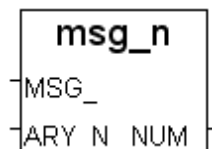

### Description : C\_Function

Extract some Integer values from a String (Message).  
These extracted Integer values are stored in the Integer array.

### Input Parameters :

<b>MSG_</b>	Message	The Message (String) to be extracted. (The length of a String is 1 to 255 bytes (characters).)
<b>ARY_NO_</b>	Integer	The Integer array No. to store these extracted Integer values I-8xx7, I-718xEG/XG: 1 ~ 6 (the Float array & Integer array use the same memory. Please use them carefully.) W-8xx7/8xx6: 1 ~ 18

### Return :

<b>NUM_</b>	Integer	The total number of Integer values been extracted. (0 ~ 128) If returns -1, it means format error.
-------------	---------	---

### Note :

1. The Integer value been extracted can be Read / Write by using "ARY\_N\_R" and "ARY\_N\_W" functions.
2. The delimiter between Integer values in the String should be "SPACE" character or "Comma" or "TAB" or "ENTER" or "NEW LINE" characters.
3. If the related value in the String is not correct Integer format, for example - ' 123 , -8G , 3' , the 2nd value is not correct Integer format, this function will return -1
4. For using MSG\_F and MSG\_N, the driver must be the version listed below or higher version:
  - I-7188EG : since ver. 2.17
  - I-7188XG : since ver. 2.15
  - I-8xx7 : since ver. 3.19
  - W-8xx7 : recommend upgrade to ver. 3.36 or higher version

### Example:

- (1.) If given MSG\_ = '3 , -567 +02' and ARY\_NO\_ = 1 , it will return NUM\_ as 3. The three Integer values are stored in Integer array No.1 's address 1 to 3 respectively. addr.1 = 3 , addr.2 = -567 , addr.3 = 2
- (2.) If given MSG\_ = '401 , 3A , +-345' and ARY\_NO\_ = 2 , it will return NUM\_ as -1. Because the 2nd value 3A and the 3rd value +-345 are not correct Integer format

### Demo Program :

1. wpdmo\_53.pia at WP-8xx7 CD-ROM:\napdos\isagraf\wp-8xx7\demo\
2. wpdmo\_53.pia at ftp://ftp.icpdas.com/pub/cd/ winpac-8xx7/napdos/isagraf/wp-8xx7/demo/



## MSGARY\_R

- I-8x17/iP-8x17 □ I-8x37/iP-8x47 □ I-7188EG/7186EG □ I-7188XG
- ISaGRAF WinCE PAC



### Description : C\_Function

Read a String from the Message array

### Input Parameters :

**ADDR\_** Integer Address to read from, 1 ~ 1024

### Return :

**MSG\_** Message The String returned (The length is between 0 to 255)

**Example:** Please refer to Chapter 11 & the wdemo\_06 of Wincon-8xx7.

## MSGARY\_W

- I-8x17/iP-8x17 □ I-8x37/iP-8x47 □ I-7188EG/7186EG □ I-7188XG
- ISaGRAF WinCE PAC

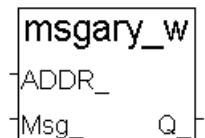

### Description : C\_Function

Write a String to the Message array

### Input Parameters :

**ADDR\_** Integer Address to write to, 1 ~ 1024

**Msg\_** Message The String to write (The length is between 0 to 255)

### Return :

**Q\_** Boolean True: ok, False: fail.

**Example:** Please refer to Chapter 11 & the wpdmo\_06 of Wincon-8xx7.

## PID\_AL

■ I-8x17/iP-8x17 ■ I-8x37/iP-8x47 ■ I-7188EG/7186EG ■ I-7188XG ■ ISaGRAF WinCE PAC

### Description : C\_Function Block

#### Example:

Please refer to Chapter 11 - Demo\_18, and ICP DAS CD-ROM:

\Napos\ISaGRAF\8000\English\_Manu\PID\_AL.Complex PID algorithm implementation.htm  
or wpdmo\_08 in WP-8xx7 CD-ROM:\napdos\isagraf\wincon\demo\ or  
<ftp://ftp.icpdas.com/pub/cd/winpac-8xx7/napdos/isagraf/wp-8xx7/demo/>

PID\_AL is a function provided by CJ International (copyright). CJ's description is listed below:

Author : EDS  
Product : ISaGRAF V3  
Date : 26 aug 96  
File : PID\_AL.Complex PID algorithm implementation.htm  
Subject : Complex PID algorithm implementation  
Keywords: PID - PID\_AL

A pid is a process regulator. Using the Feed Back concept, an output is regulated according to the difference between what it is really and what it should be.

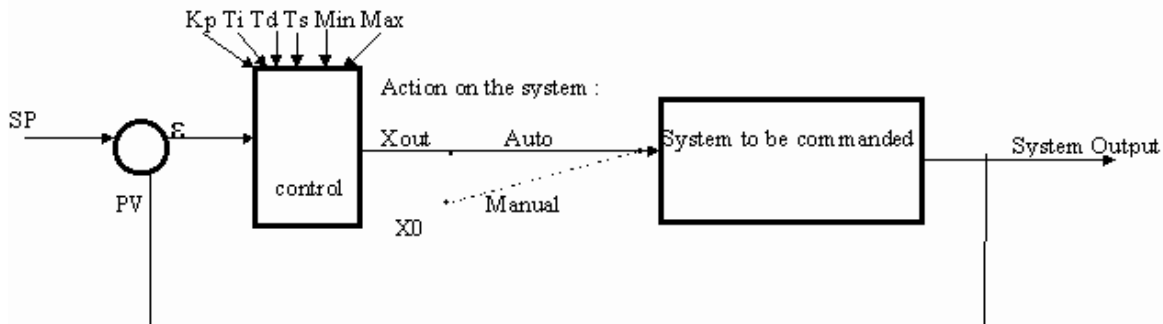

PV is the output. At the entry the error  $e$  is calculated as the difference  $SP - PV$ . The control calculates the action to do on the system to keep the regulation.

System to command : for the simulation, it is a second order system that has been simulated.

On the contrary, on a non regulated system we have :

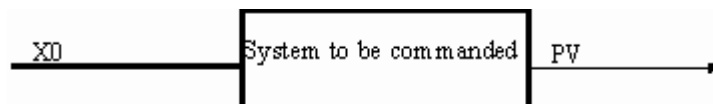

Major points of the PID described here :

SP is the set point : value wanted at the output.

X0 (open loop case, in manual mode) is the non regulated value entering the system.

Xout (close loop case with regulation) is the regulated value entering the system.

CJ PID-A1 description

call: - Auto:automatic or manual mode

Pv :Process output value

Sp :Set point value

X0 :Adjustment value: In manual mode, output pid controller equal to X0

Kp :Proportionality constant

Ti :Integral time constant

Td :derivative time constant

Ts :Sampling period

Min, Max : range of accepted values of Xout

return: - Xout : Command

prototype: - PID (Auto,Pv,Sp,X0,Kp,Ti,Td,Ts, Min, Max);

command := PID.Xout;

notes: - automatic mode must be set to false at init

- The implemented model is :

$$u(t) = Kp(A(t) + \frac{1}{Ti} \int_0^t A(t)d(t) + Td \frac{dA(t)}{dt})$$

Theoretical Continue formula

$$u(k) = Kp(A(k) + \frac{Ts}{Ti}I(k) + \frac{Td}{Ts}[A(k) - A(k-1)])$$

Implemented Discret formula

$$I(k) = I(k-1) + A(k)Ts$$

---

Copyright CJ International 1996.

## PLC\_mode

- I-8x17/iP-8x17 □ I-8x37/iP-8x47 □ I-7188EG/7186EG □ I-7188XG
- ISaGRAF WinCE PAC

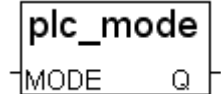

### Description : C\_Function

Change Wincon PLC speed

### Input Parameters :

**MODE\_** Integer Can be 0 , 1, 2, or 3  
0: Fast Mode, default setting, the minimum PLC scan time is 4 ms  
1: Slow Mode, the minimum PLC scan time is about 6 to 7 ms  
2: Slower Mode, the minimum PLC scan time is about 9 to 11 ms  
3 or other value: Slowest Mode, the minimum PLC scan time is about 19 to 21 ms

### Return :

**Q\_** Boolean Return TRUE always

### Note :

1. The "PLC\_mode" is supported since driver of version 3.24B
2. The system's default setting is "Fast Mode"
3. User may call "PLC\_mode( )" in the first PLC scan to change the PLC speed.
4. The reason to slow down the PLC speed is to improve the speed performance of other HMI program running with ISaGRAF driver at the same time. Ex: running Indusoft with ISaGRAF in the same Wincon.

### Example :

```
(* TMP is declared as Boolean internal variable *)
(* INIT is declared as Boolean internal variable and init at TRUE *)
if INIT then
  INIT := False ; (*Only do it once in the 1st PLC scan*)
  TMP := PLC_mode(2) ; (*Set PLC speed to 2:slower mode*)
end_if ;
```

The PWM functions listed below are C\_Function, please refer to User manual Section 3.7 for detail information and examples.

## **PWM\_DIS**

■ I-8x17/iP-8x17 ■ I-8x37/iP-8x47 ■ I-7188EG/7186EG ■ I-7188XG ■ ISaGRAF WinCE PAC  
Function            Disable PWM output

## **PWM\_EN**

■ I-8x17/iP-8x17 ■ I-8x37/iP-8x47 ■ I-7188EG/7186EG ■ I-7188XG ■ ISaGRAF WinCE PAC  
Function            Enable PWM input.

## **PWM\_EN2**

■ I-8x17/iP-8x17 ■ I-8x37/iP-8x47 ■ I-7188EG/7186EG ■ I-7188XG ■ ISaGRAF WinCE PAC  
Function            Enable PWM output to output some pulse

## **PWM\_OFF**

■ I-8x17/iP-8x17 ■ I-8x37/iP-8x47 ■ I-7188EG/7186EG ■ I-7188XG ■ ISaGRAF WinCE PAC  
Function            Set parallel D/O to False immediately

## **PWM\_ON**

■ I-8x17/iP-8x17 ■ I-8x37/iP-8x47 ■ I-7188EG/7186EG ■ I-7188XG ■ ISaGRAF WinCE PAC  
Function            Set parallel D/O to TRUE immediately

## **PWM\_SET**

■ I-8x17/iP-8x17 ■ I-8x37/iP-8x47 ■ I-7188EG/7186EG ■ I-7188XG ■ ISaGRAF WinCE PAC  
Function            Dynamical change the ON\_, OFF\_ & NUM\_ setting

## **PWM\_STS**

■ I-8x17/iP-8x17 ■ I-8x37/iP-8x47 ■ I-7188EG/7186EG ■ I-7188XG ■ ISaGRAF WinCE PAC  
Function            Get PWM status

## **PWM\_STS2**

■ I-8x17/iP-8x17 ■ I-8x37/iP-8x47 ■ I-7188EG/7186EG ■ I-7188XG ■ ISaGRAF WinCE PAC  
Function            Get the pulse number which has been output by “pwm\_en2” or “pwm\_en”

## R\_MB\_ADR

■ I-8x17/iP-8x17 ■ I-8x37/iP-8x47 ■ I-7188EG/7186EG ■ I-7188XG ■ ISaGRAF WinCE PAC

### Description : C\_Function

Read Boolean or Integer variable by using Modbus address

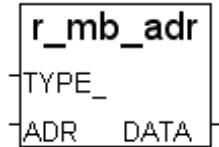

### Input Parameters :

**TYPE\_** Integer 0: Boolean variable; 1: Integer variable  
**ADR\_** Integer The Modbus address to read,  
Valid range: 1~4095 for I-8xx7 & I-7188xG; 1~8191 for Wincon.

### Return :

**DATA\_** Integer The read Integer value (if TYPE\_ is Boolean, 0: False, 1: True)

### Note :

1. Please use R\_MB\_REL function to read "REAL" variable.
2. If no variable defined with the given Modbus address, this function returns 0.
3. If TYPE\_ is given as Integer however the related variable is "Boolean" typed, the returned value is (0: False, 1: True)
4. If TYPE\_ is given as Integer however the related variable is "Real" typed, the related 32-bit is copied to DATA\_. User can use "int\_real" function to map this 32-bit Integer to a Real value. (It is better to use "R\_MB\_REL" to read "Real" variable)
5. If TYPE\_ is given as Boolean however the related variable is not "Boolean" typed, returns 0.
6. If Long Integer value (32-bit Integer) is to be delivered to HMI via Modbus protocol, it should occupy 2 Modbus address Number. Please refer to Section 4.2 of "User's Manual Of The ISaGRAF PAC".
7. "**R\_MB\_ADR(1,9994)**" and "**R\_MB\_ADR(1,9995)**" are special usage for sending email with attached file via Ethernet communication. Please refer to Chapter 12.
8. "**R\_MB\_ADR(1,9998)**" and "**R\_MB\_ADR(1,9999)**" are special usage for detecting controller fault. Please refer to section 10.6

## R\_MB\_REL

■ I-8x17/iP-8x17 ■ I-8x37/iP-8x47 ■ I-7188EG/7186EG ■ I-7188XG ■ ISaGRAF WinCE PAC

### Description : C\_Function

Read Real variable by using Modbus address

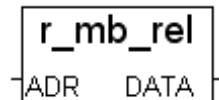

### Input Parameters :

**ADR\_** Integer The Modbus address to read,  
Valid range: 1~4095 for I-8xx7 & I-7188xG, 1~8191 for Wincon

### Return :

**DATA\_** Real The read Real value

### Note :

1. Please make sure the related variable is typed of "Real". If it is "Integer", please use "R\_MB\_ADR" function.
2. If the related variable type is not "Analog" (Real or Integer), this function returns 1.23E-20
3. If no variable defined with the given Modbus address, this function returns 1.23E-20
4. If Real value is to be delivered to HMI via Modbus protocol, it should occupy 2 Modbus address No. Please refer to Section 4.2 of "User's Manual Of The ISaGRAF PAC".
5. If the related variable type is not "Real", it may cause Local Fault of No.103. Please refer to Section 10.6.

## R\_TRIG

■ I-8x17/iP-8x17 ■ I-8x37/iP-8x47 ■ I-7188EG/7186EG ■ I-7188XG ■ ISaGRAF WinCE PAC

### Description : Standard\_Function

Detect a rising edge of a Boolean variable.

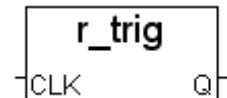

### Input Parameters :

**CLK** Boolean Any Boolean variable

### Return :

**Q** Boolean TRUE: CLK rises from FALSE to TRUE  
FALSE: all other cases

### Example :

(\* FBD Program \*)

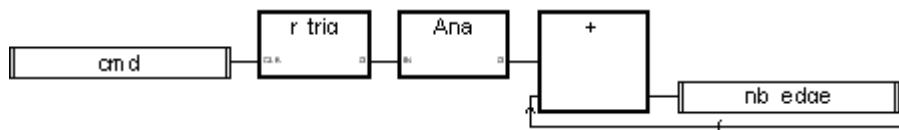

(\* ST Equivalence: We suppose R\_TRIG1 is an instance of R\_TRIG block. \*)

```
R_TRIG1(cmd);  
nb_edge := ANA(R_TRIG1.Q) + nb_edge;
```

(\* IL Equivalence: \*)

```
LD      cmd  
ST      R_TRIG1.clk  
CAL     R_TRIG1  
LD      R_TRIG1.Q  
ANA  
ADD     nb_edge  
ST      nb_edge
```

The following RDN functions are Redundant related functions, please refer to The ISaGRAF User Manual Chapter 20 for detail information and examples.

### RDN\_A

- I-8x17/iP-8x17 □ I-8x37/iP-8x47 □ I-7188EG/7186EG □ I-7188XG
- ISaGRAF WinCE PAC

C\_Function            Set a "Variable Array" as Redundant synchronous data.

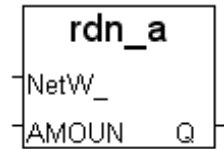

### RDN\_B

- I-8x17/iP-8x17 □ I-8x37/iP-8x47 □ I-7188EG/7186EG □ I-7188XG
- ISaGRAF WinCE PAC

C\_Function            Set a Boolean variable as Redundant synchronous data.

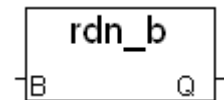

### RDN\_F

- I-8x17/iP-8x17 □ I-8x37/iP-8x47 □ I-7188EG/7186EG □ I-7188XG
- ISaGRAF WinCE PAC

C\_Function            Set a Real variable as Redundant synchronous data.

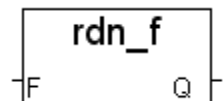

### RDN\_N

- I-8x17/iP-8x17 □ I-8x37/iP-8x47 □ I-7188EG/7186EG □ I-7188XG
- ISaGRAF WinCE PAC

C\_Function            Set an Integer variable as Redundant synchronous data.

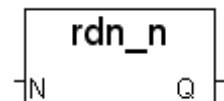

### RDN\_T

- I-8x17/iP-8x17 □ I-8x37/iP-8x47 □ I-7188EG/7186EG □ I-7188XG
- ISaGRAF WinCE PAC

C\_Function            Set a Timer variable as Redundant synchronous data.

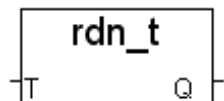

### Note:

1. The ISaGRAF program for the 2 redundant Wincon controllers is the same project.
2. All I-7K & I-87K remote IO function blocks should be located on the top of the ISaGRAF project.
3. Before using RDN\_functions, please make sure the "rdn" of "IO complex equipment" is well connected in the ISaGRAF IO connection window.
4. RDN\_B, RDN\_F, RDN\_N, RDN\_T, RDN\_A must be called only in the 1st PLC scan.
5. Max number of synchronous bytes is 6000 bytes. Boolean: 1 byte; Integer & Real & Timer is 4 bytes.
6. Please refer to Chapter 20 for more information.



## REAL

■ I-8x17/iP-8x17 ■ I-8x37/iP-8x47 ■ I-7188EG/7186EG ■ I-7188XG ■ ISaGRAF WinCE PAC

### Description : Standard\_Function

Convert any variable to a REAL one.

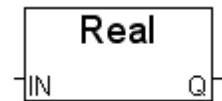

### Input Parameters :

**IN** Any Any non-Real analog value (no message)

### Return :

**Q** Real If IN is FALSE, return 0.0; if IN is TRUE, return 1.0.  
If IN is a Timer, it return the number of millisecond.  
If IN is an analog Integer, it return the equivalent number.

### Example :

(\* FBD Program \*)

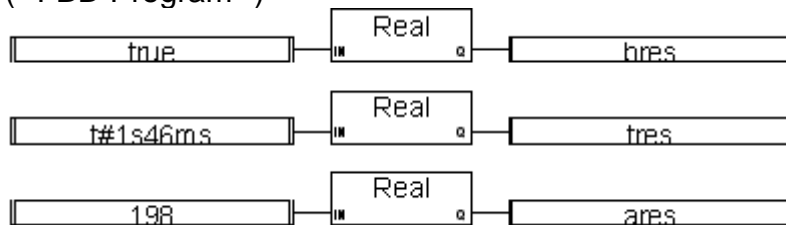

(\* ST Equivalence: \*)

bres := REAL (true); (\* bres is 1.0 \*)  
tres := REAL (t#1s46ms); (\* tres is 1046.0 \*)  
ares := REAL (198); (\* ares is 198.0 \*)

(\* IL Equivalence: \*)

```
LD      true
REAL
ST      bres
LD      t#1s46ms
REAL
ST      tres
LD      198
REAL
ST      ares
```

## REA\_STR2

■ I-8x17/iP-8x17 ■ I-8x37/iP-8x47 ■ I-7188EG/7186EG ■ I-7188XG ■ ISaGRAF WinCE PAC

### Description : C\_Function

Convert a Real value to a String with fixed digit number

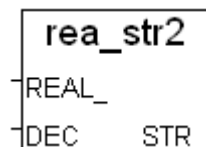

### Input Parameters:

<b>REAL_</b>	Real	The Real value to convert
<b>DEC_</b>	Integer	The digit number after the dot "." symbol (0 ~ 5)

### Return:

<b>STR_</b>	Message	The String returned (Max. length is 13). Ex: DEC_ = 2 1.234 ---> '1.23' 123456.0 ---> '123456.00' 0.00001234 ---> '0.00'
-------------	---------	--

**Note:** Converting a String to a Real please use "STR\_REAL".

**Example:** Please refer to Chapter 16 and demo\_38, demo\_39

## REAL\_INT

■ I-8x17/iP-8x17 ■ I-8x37/iP-8x47 ■ I-7188EG/7186EG ■ I-7188XG ■ ISaGRAF WinCE PAC

### Description : C\_Function

Map a Real value to a Long Integer.

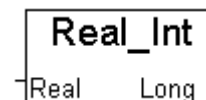

### Input Parameters:

<b>Real_</b>	Real	The Real value to map
--------------	------	-----------------------

### Return:

<b>Long_</b>	Integer	The 32-bit Integer after mapping
--------------	---------	----------------------------------

### Note:

1. Mapping an Integer to a Real please use "Int\_Real".
2. Converting a Real to an Integer please use ANA( ), Ex: -76.345 → -76

## REAL\_STR

■ I-8x17/iP-8x17 ■ I-8x37/iP-8x47 ■ I-7188EG/7186EG ■ I-7188XG ■ ISaGRAF WinCE PAC

### Description : C\_Function

Convert a Real value to a String.

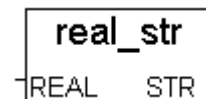

### Input Parameters :

<b>REAL_</b>	Real	The Real value to convert
--------------	------	---------------------------

### Return :

<b>STR_</b>	Message	The returned String (Max. length is 13),. 1.234 ---> '1.234' 123456789.0 ---> '1.23457E+008' 0.00001234 ---> '1.234E-005'
-------------	---------	--

## RETAIN\_A

- I-8x17/iP-8x17 ■ I-8x37/iP-8x47 ■ I-7188EG/7186EG ■ I-7188XG
- ISaGRAF WinCE PAC

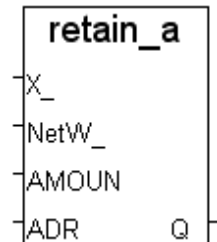

### Description : C\_Function

Set a "Variable array" to be as "retained variable" by using its 1st element's Network address No.

\* Please refer to Chapter 10 for detail information.

\* ISaGRAF controllers support "Retained Variable" function since the following driver version:

Target 1: I-8417/8817/8437/8837 + S-256 or S-512 (Retained variable), since driver Ver 3.13  
iP-8xx7 or  $\mu$ PAC-7186EG + X607 (or X608)

Target 2: I-7188EG + X607 or X608 (Retained variable), since driver Ver 2.11

Target 3: I-7188XG + X607 or X608 (Retained variable), since driver Ver 2.09

Target 4: W-8xx7/8xx6 + S-256 or S-512 (Retained variable), since driver Ver 3.26  
WP-8xx7, VP-2Xw7, XP-8xx7-CE6, XP-8xx7-Atom-CE6

### Input Parameters :

<b>X_</b>	Message	'B' or 'b': Boolean, 'N' or 'n': Integer, 'F' or 'f': Real, 'T' or 't': Timer
<b>NetW_</b>	Integer	Network address No. for the 1st element of the "Variable Array". Target 1/2/3 : 1~4095 , Target 4: 1~8191
<b>Amount_</b>	Integer	the size of the "Variable Array", Valid range: 1~255, Ex: CNT[0..15] has size of 16, ABC[0..7] has size of 8.
<b>ADR_</b>	Integer	The retained address inside the retained memory for this variable. Target 1/2/3: Boolean & Timer: 1~256; Integer & Real: 1~1024. Target 4: Boolean (1 ~ 2048), Timer (1 ~ 1024), Integer and Real (1 ~ 4096)

### Return :

<b>Q_</b>	Boolean	True: ok; False: error (ex: cannot find retained variable)
-----------	---------	--

### Note :

- Before using Retain\_X, Retain\_A, Retain\_N, Retain\_B, Retain\_F & Retain\_T functions, please make sure that the device (listed below) of "IO complex equipment" in the ISaGRAF IO connection window is well connected.
  - I-7188EG/XG: "X607\_608"
  - I-8417/8817/8437/8837 & W-8037/8337/8737: "S256\_512"
- To declare a "Variable Array" for ISaGRAF version 3.4 (or 3.5), please edit the "isa.ini" file in the ISaGRAF sub-directory "C:\ISAWIN\EXE\". And then when you open the ISaGRAF workbench, there will be a "DIM" area in the Dictionary Declaration Windows for you to assign the size of the "variable array".  
Edit c:\isawin\exe\isa.ini file, add these 2 lines at the beginning of the file content:  
[DEBUG]  
arrays=1
- Before using "Retain\_A", please assign a network address number to "network address" column in the ISaGRAF dictionary window. Please **DO NOT** check the "Retain" box. Ex: Assign "Network Address"= 1A (Hex., Decimal 26) to Integer "variable array": CNT[0..7].
- Please make sure the retain memory (7188EG/XG: X607/X608, I-8xx7 & W-8xx7: S-256/S-512) is well plugged in the controller.
- The WP-8xx7, VP-2xW7, XP-8xx7-CE6, XP-8xx7-Atom-CE6, iP-8xx7 and VP-2117 have already built-in a battery backup memory for retain variables.
- If the PAC is WP-5xx7, please refer to [FAQ-155](#).

## RETAIN\_B

- I-8x17/iP-8x17 ■ I-8x37/iP-8x47 ■ I-7188EG/7186EG ■ I-7188XG
- ISaGRAF WinCE PAC

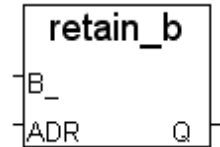

### Description : C\_Function

Set a Boolean variable to be as "Retained Variable"

- \* Please refer to Chapter 10 for detail information.
- \* ISaGRAF controllers support "Retained Variable" function since the following driver version:
  - Target 1: I-8417/8817/8437/8837 + S-256 or S-512 (Retained variable), since driver Ver 3.13 iP-8xx7 or µPAC-7186EG + X607 (or X608)
  - Target 2: I-7188EG + X607 or X608 (Retained variable), since driver Ver 2.11
  - Target 3: I-7188XG + X607 or X608 (Retained variable), since driver Ver 2.09
  - Target 4: W-8xx7/8xx6 + S-256 or S-512 (Retained variable), since driver Ver 3.26 WP-8xx7, VP-2Xw7, XP-8xx7-CE6, XP-8xx7-Atom-CE6

### Input Parameters:

<b>B_</b>	Boolean	B_ should be a Boolean variable name, not a constant value.
<b>ADR_</b>	Integer	The retained address inside the retained memory for this Boolean variable. Target 1 & 2 & 3: 1 ~ 256; Target 4: 1 ~ 2048

### Return:

<b>Q_</b>	Boolean	True: ok; False: error (ex: cannot find retained variable)
-----------	---------	--

### Note:

- Before using Retain\_X, Retain\_A, Retain\_N, Retain\_B, Retain\_F & Retain\_T functions, please make sure that the device (listed below) of "IO complex equipment" in the ISaGRAF IO connection window is well connected.
  - I-7188EG/XG: "X607\_608"
  - I-8417/8817/8437/8837 & W-8037/8337/8737: "S256\_512"
- To declare a "Variable Array" for ISaGRAF version 3.4 (or 3.5), please edit the "isa.ini" file in the ISaGRAF sub-directory "C:\ISAWIN\EXE\". And then when you open the ISaGRAF workbench, there will be a "DIM" area in the Dictionary Declaration Windows for you to assign the size of the "variable array".  
Edit c:\isawin\exe\isa.ini file, add these 2 lines at the beginning of the file content:

```
[DEBUG]
arrays=1
```
- Before using "Retain\_A", please assign a network address number to "network address" column in the ISaGRAF dictionary window. Please **DO NOT** check the "Retain" box. Ex: Assign "Network Address"= 1A (Hex., Decimal 26) to Integer "variable array": CNT[0..7].
- Please make sure the retain memory (7188EG/XG: X607/X608, I-8xx7 & W-8xx7: S-256/S-512) is well plugged in the controller.
- The WP-8xx7, VP-2xW 7, XP-8xx7-CE6, XP-8xx7-Atom-CE6, iP-8xx7 and VP-2117 have already built-in a battery backup memory for retain variables.
- If the PAC is WP-5xx7, please refer to [FAQ-155](#).

## RETAIN\_F

- I-8x17/iP-8x17 ■ I-8x37/iP-8x47 ■ I-7188EG/7186EG ■ I-7188XG
- ISaGRAF WinCE PAC

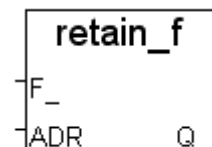

### Description : C\_Function

Set a Real variable to be as "Retained Variable"

- \* Please refer to Chapter 10 for detail information.
- \* ISaGRAF controllers support "Retained Variable" function since the following driver version:
  - Target 1: I-8417/8817/8437/8837 + S-256 or S-512 (Retained variable), since driver Ver 3.13  
iP-8xx7 or μPAC-7186EG + X607 (or X608)
  - Target 2: I-7188EG + X607 or X608 (Retained variable), since driver Ver 2.11
  - Target 3: I-7188XG + X607 or X608 (Retained variable), since driver Ver 2.09
  - Target 4: W-8xx7/8xx6 + S-256 or S-512 (Retained variable), since driver Ver 3.26  
WP-8xx7, VP-2Xw7, XP-8xx7-CE6, XP-8xx7-Atom-CE6

### Input Parameters :

<b>F_</b>	Real	F_ should be a Real variable name, not a constant value.
<b>ADR_</b>	Integer	The retained address inside the retained memory for this Real variable. Target 1 & 2 & 3: 1~1024; Target 4: 1 ~ 4096

### Return :

<b>Q_</b>	Boolean	True: ok; False: error (ex: cannot find retained variable)
-----------	---------	--

### Note :

- Before using Retain\_X, Retain\_A, Retain\_N, Retain\_B, Retain\_F & Retain\_T functions, please make sure that the device (listed below) of "IO complex equipment" in the ISaGRAF IO connection window is well connected.
  - I-7188EG/XG: "X607\_608"
  - I-8417/8817/8437/8837 & W-8037/8337/8737: "S256\_512"
- To declare a "Variable Array" for ISaGRAF version 3.4 (or 3.5), please edit the "isa.ini" file in the ISaGRAF sub-directory "C:\ISAWIN\EXE\". And then when you open the ISaGRAF workbench, there will be a "DIM" area in the Dictionary Declaration Windows for you to assign the size of the "variable array".  
Edit c:\isawin\exe\isa.ini file, add these 2 lines at the beginning of the file content:  
[DEBUG]  
arrays=1
- Before using "Retain\_A", please assign a network address number to "network address" column in the ISaGRAF dictionary window. Please **DO NOT** check the "Retain" box. Ex: Assign "Network Address"= 1A (Hex., Decimal 26) to Integer "variable array": CNT[0..7].
- Please make sure the retain memory (7188EG/XG: X607/X608, I-8xx7 & W-8xx7: S-256/S-512) is well plugged in the controller.
- The WP-8xx7, VP-2xW 7, XP-8xx7-CE6, XP-8xx7-Atom-CE6, iP-8xx7 and VP-2117 have already built-in a battery backup memory for retain variables.
- If the PAC is WP-5xx7, please refer to [FAQ-155](#).

## RETAIN\_N

- I-8x17/iP-8x17 ■ I-8x37/iP-8x47 ■ I-7188EG/7186EG ■ I-7188XG
- ISaGRAF WinCE PAC

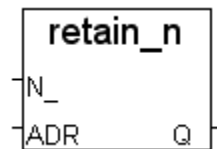

### Description : C\_Function

Set an Integer variable to be as "Retained Variable"

- \* Please refer to Chapter 10 for detail information.
- \* ISaGRAF controllers support "Retained Variable" function since the following driver version:
  - Target 1: I-8417/8817/8437/8837 + S-256 or S-512 (Retained variable), since driver Ver 3.13  
iP-8xx7 or μPAC-7186EG + X607 (or X608)
  - Target 2: I-7188EG + X607 or X608 (Retained variable), since driver Ver 2.11
  - Target 3: I-7188XG + X607 or X608 (Retained variable), since driver Ver 2.09
  - Target 4: W-8xx7/8xx6 + S-256 or S-512 (Retained variable), since driver Ver 3.26  
WP-8xx7, VP-2Xw7, XP-8xx7-CE6, XP-8xx7-Atom-CE6

### Input Parameters :

<b>N_</b>	Integer	N_ should be an Integer variable name, not a constant value.
<b>ADR_</b>	Integer	The retained address inside the retained memory for this Integer variable. Target 1 & 2 & 3: 1~1024; Target 4: 1 ~ 4096

### Return :

<b>Q_</b>	Boolean	True: ok; False: error (ex: cannot find retained variable)
-----------	---------	--

### Note :

- Before using Retain\_X, Retain\_A, Retain\_N, Retain\_B, Retain\_F & Retain\_T functions, please make sure that the device (listed below) of "IO complex equipment" in the ISaGRAF IO connection window is well connected.
  - I-7188EG/XG: "X607\_608"
  - I-8417/8817/8437/8837 & W-8037/8337/8737: "S256\_512"
- To declare a "Variable Array" for ISaGRAF version 3.4 (or 3.5), please edit the "isa.ini" file in the ISaGRAF sub-directory "C:\ISAWIN\EXE\". And then when you open the ISaGRAF workbench, there will be a "DIM" area in the Dictionary Declaration Windows for you to assign the size of the "variable array".  
Edit c:\isawin\exe\isa.ini file, add these 2 lines at the beginning of the file content:  
[DEBUG]  
arrays=1
- Before using "Retain\_A", please assign a network address number to "network address" column in the ISaGRAF dictionary window. Please **DO NOT** check the "Retain" box. Ex: Assign "Network Address"= 1A (Hex., Decimal 26) to Integer "variable array": CNT[0..7].
- Please make sure the retain memory (7188EG/XG: X607/X608, I-8xx7 & W-8xx7: S-256/S-512) is well plugged in the controller.
- The WP-8xx7, VP-2xW 7, XP-8xx7-CE6, XP-8xx7-Atom-CE6, iP-8xx7 and VP-2117 have already built-in a battery backup memory for retain variables.
- If the PAC is WP-5xx7, please refer to [FAQ-155](#).

## RETAIN\_T

- I-8x17/iP-8x17 ■ I-8x37/iP-8x47 ■ I-7188EG/7186EG ■ I-7188XG
- ISaGRAF WinCE PAC

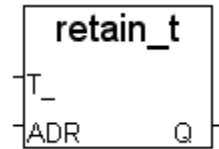

### Description : C\_Function

Set a Timer variable to be as "Retained Variable"

- \* Please refer to Chapter 10 for detail information.
- \* ISaGRAF controllers support "Retained Variable" function since the following driver version:
  - Target 1: I-8417/8817/8437/8837 + S-256 or S-512 (Retained variable), since driver Ver 3.13  
iP-8xx7 or μPAC-7186EG + X607 (or X608)
  - Target 2: I-7188EG + X607 or X608 (Retained variable), since driver Ver 2.11
  - Target 3: I-7188XG + X607 or X608 (Retained variable), since driver Ver 2.09
  - Target 4: W-8xx7/8xx6 + S-256 or S-512 (Retained variable), since driver Ver 3.26  
WP-8xx7, VP-2Xw7, XP-8xx7-CE6, XP-8xx7-Atom-CE6

### Input Parameters :

<b>T_</b>	Timer	T_ should be a Timer variable name, not a constant value.
<b>ADR_</b>	Integer	The retained address inside the retained memory for this Timer variable. Target 1 & 2 & 3: 1 ~ 256; Target 4: 1 ~ 1024

### Return :

<b>Q_</b>	Boolean	True: ok; False: error (ex: cannot find retained variable)
-----------	---------	--

### Note :

- Before using Retain\_X, Retain\_A, Retain\_N, Retain\_B, Retain\_F & Retain\_T functions, please make sure that the device (listed below) of "IO complex equipment" in the ISaGRAF IO connection window is well connected.
  - I-7188EG/XG: "X607\_608"
  - I-8417/8817/8437/8837 & W-8037/8337/8737: "S256\_512"
- To declare a "Variable Array" for ISaGRAF version 3.4 (or 3.5), please edit the "isa.ini" file in the ISaGRAF sub-directory "C:\ISAWIN\EXE\". And then when you open the ISaGRAF workbench, there will be a "DIM" area in the Dictionary Declaration Windows for you to assign the size of the "variable array".  
Edit c:\isawin\exe\isa.ini file, add these 2 lines at the beginning of the file content:  
[DEBUG]  
arrays=1
- Before using "Retain\_A", please assign a network address number to "network address" column in the ISaGRAF dictionary window. Please **DO NOT** check the "Retain" box. Ex: Assign "Network Address"= 1A (Hex., Decimal 26) to Integer "variable array": CNT[0..7].
- Please make sure the retain memory (7188EG/XG: X607/X608, I-8xx7 & W-8xx7: S-256/S-512) is well plugged in the controller.
- The WP-8xx7, VP-2xW 7, XP-8xx7-CE6, XP-8xx7-Atom-CE6, iP-8xx7 and VP-2117 have already built-in a battery backup memory for retain variables.
- If the PAC is WP-5xx7, please refer to [FAQ-155](#).

## RETAIN\_X

- I-8x17/iP-8x17 ■ I-8x37/iP-8x47 ■ I-7188EG/7186EG ■ I-7188XG
- ISaGRAF WinCE PAC

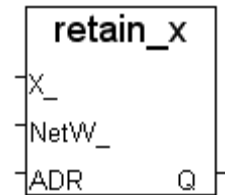

### Description : C\_Function

Set a variable to be as "Retained Variable" by using its Network address number.

- \* Please refer to Chapter 10 for detail information.
- \* ISaGRAF controllers support "Retained Variable" function since the following driver version:
  - Target 1: I-8417/8817/8437/8837 + S-256 or S-512 (Retained variable), since driver Ver 3.13  
iP-8xx7 or μPAC-7186EG + X607 (or X608)
  - Target 2: I-7188EG + X607 or X608 (Retained variable), since driver Ver 2.11
  - Target 3: I-7188XG + X607 or X608 (Retained variable), since driver Ver 2.09
  - Target 4: W-8xx7/8xx6 + S-256 or S-512 (Retained variable), since driver Ver 3.26  
WP-8xx7, VP-2Xw7, XP-8xx7-CE6, XP-8xx7-Atom-CE6

### Input Parameters :

<b>X_</b>	Message	'B' or 'b': Boolean, 'N' or 'n' : Integer, 'F' or 'f' : Real, 'T' or 't' : Timer
<b>NetW_</b>	Integer	By using its Network address No. Target 1/2/3 : 1 ~ 4095; Target 4: 1 ~ 8191
<b>ADR_</b>	Integer	The retained address inside the retained memory for this variable. Target 1/2/3 : Boolean and Timer (1 ~ 256), Integer and Real (1 ~ 1024); Target 4: Boolean (1 ~ 2048), Timer (1 ~ 1024) , Integer and Real (1 ~ 4096)

### Return :

<b>Q_</b>	Boolean	True: ok; False: error (ex: cannot find retained variable)
-----------	---------	--

### Note :

- Before using Retain\_X, Retain\_A, Retain\_N, Retain\_B, Retain\_F & Retain\_T functions, please make sure that the device (listed below) of "IO complex equipment" in the ISaGRAF IO connection window is well connected.
  - I-7188EG/XG: "X607\_608"
  - I-8417/8817/8437/8837 & W-8037/8337/8737: "S256\_512"
- To declare a "Variable Array" for ISaGRAF version 3.4 (or 3.5), please edit the "isa.ini" file in the ISaGRAF sub-directory "C:\ISAWIN\EXE\". And then when you open the ISaGRAF workbench, there will be a "DIM" area in the Dictionary Declaration Windows for you to assign the size of the "variable array".  
Edit c:\isawin\exe\isa.ini file, add these 2 lines at the beginning of the file content:

```
[DEBUG]
arrays=1
```
- Before using "Retain\_A", please assign a network address number to "network address" column in the ISaGRAF dictionary window. Please **DO NOT** check the "Retain" box. Ex: Assign "Network Address"= 1A (Hex., Decimal 26) to Integer "variable array": CNT[0..7].
- Please make sure the retain memory (7188EG/XG: X607/X608, I-8xx7 & W-8xx7: S-256/S-512) is well plugged in the controller.
- The WP-8xx7, VP-2xW 7, XP-8xx7-CE6, XP-8xx7-Atom-CE6, iP-8xx7 and VP-2117 have already built-in a battery backup memory for retain variables.
- If the PAC is WP-5xx7, please refer to [FAQ-155](#).



## S\_B\_R

- I-8x17/iP-8x17 ■ I-8x37/iP-8x47 ■ I-7188EG/7186EG ■ I-7188XG
- ISaGRAF WinCE PAC



### Description: C\_Function

Read one Boolean from the volatile SRAM

### Input Parameters:

**ADR\_** Integer The address to read, one Boolean occupy 1 byte.

S256: 1 ~ 249,856 (1 ~ 16#3D000)

S512: 1 ~ 512,000 (1 ~ 16#7D000)

X607: 1 ~ 118,784 (1 ~ 16#1D000)

X608: 1 ~ 512,000 (1 ~ 16#7D000)

### Return:

**BOO\_** Boolean The Boolean value been read, 0=FALSE, not 0 = TRUE

## S\_B\_W

- I-8x17/iP-8x17 ■ I-8x37/iP-8x47 ■ I-7188EG/7186EG ■ I-7188XG
- ISaGRAF WinCE PAC

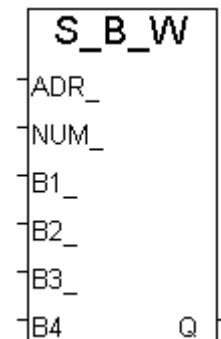

### Description : C\_Function

Write up to 4 Booleans to the volatile SRAM

### Input Parameters :

**ADR\_** Integer The starting address to write, 1 Boolean occupy 1 byte.

S256: 1 ~ 249,856 (1 ~ 16#3D000)

S512: 1 ~ 512,000 (1 ~ 16#7D000)

X607: 1 ~ 118,784 (1 ~ 16#1D000)

X608: 1 ~ 512,000 (1 ~ 16#7D000)

**NUM\_** Integer How many Boolean to write, 0 ~ 4

**B1\_~B4\_** Boolean The Boolean value to write

### Return :

**Q\_** Boolean Ok: TRUE, fail: FALSE  
The Boolean value will be stored is FALSE=0, TRUE=1

**Example :** demo\_40, demo\_41, demo\_42, demo\_44

Please refer to Section 10.3.

## S\_BY\_R

- I-8x17/iP-8x17 ■ I-8x37/iP-8x47 ■ I-7188EG/7186EG ■ I-7188XG
- ISaGRAF WinCE PAC

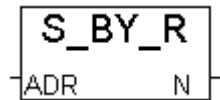

### Description : C\_Function

Read one Byte from the volatile SRAM

### Input Parameters :

**ADR\_** Integer The address to read, one Byte occupy 1 byte.

S256: 1 ~ 249,856 (1 ~ 16#3D000)

S512: 1 ~ 512,000 (1 ~ 16#7D000)

X607: 1 ~ 118,784 (1 ~ 16#1D000)

X608: 1 ~ 512,000 (1 ~ 16#7D000)

### Return :

**N\_** Integer The Byte value been read, 0 ~ 255

## S\_BY\_W

- I-8x17/iP-8x17 ■ I-8x37/iP-8x47 ■ I-7188EG/7186EG ■ I-7188XG
- ISaGRAF WinCE PAC

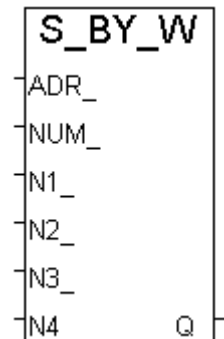

### Description : C\_Function

Write up to 4 Bytes to the volatile SRAM

### Input Parameters :

**ADR\_** Integer The starting address to write, 1 Byte occupy 1 byte.

S256: 1 ~ 249,856 (1 ~ 16#3D000)

S512: 1 ~ 512,000 (1 ~ 16#7D000)

X607: 1 ~ 118,784 (1 ~ 16#1D000)

X608: 1 ~ 512,000 (1 ~ 16#7D000)

**NUM\_** Integer How many Byte to write, 0 ~ 4

**N1\_~N4\_** Boolean The Byte value to write, 0~255

### Return :

**Q\_** Boolean Ok: TRUE, fail: FALSE

**Example :** demo\_40, demo\_41, demo\_42, demo\_44

Please refer to Section 10.3.

## S\_DL\_DIS

■ I-8x17/iP-8x17 ■ I-8x37/iP-8x47 ■ I-7188EG/7186EG ■ I-7188XG  
□ ISaGRAF WinCE PAC

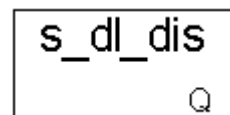

### Description : C\_Function

Disable the download permission, so that PC can not download data to the SRAM

### Return :

Q\_ Boolean Ok: TRUE, fail: FALSE

## S\_DL\_EN

■ I-8x17/iP-8x17 ■ I-8x37/iP-8x47 ■ I-7188EG/7186EG ■ I-7188XG  
□ ISaGRAF WinCE PAC

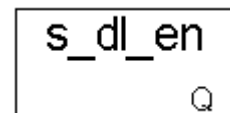

### Description : C\_Function

Enable the download permission for PC to download data to the volatile SRAM

### Return :

Q\_ Boolean Ok: TRUE, fail: FALSE

### Note:

The default setting is "Disable". S\_DL\_EN should be called, then PC can download data to the volatile SRAM.

## S\_DL\_RST

■ I-8x17/iP-8x17 ■ I-8x37/iP-8x47 ■ I-7188EG/7186EG ■ I-7188XG □ ISaGRAF WinCE PAC

### Description : C\_Function

Reset the Download Status to "-1:No action" for the volatile SRAM.

### Return :

Q\_ Boolean Ok: TRUE, fail: FALSE

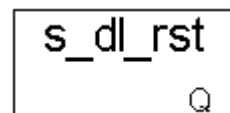

## S\_DL\_STS

■ I-8x17/iP-8x17 ■ I-8x37/iP-8x47 ■ I-7188EG/7186EG ■ I-7188XG □ ISaGRAF WinCE PAC

### Description: C\_Function

Get PC's download status for the volatile SRAM

### Return:

STS\_ Integer

- 1: no action
- 1: PC is downloading data to the SRAM now
- 2: download accomplished
- 3: PC request to download, but download never been accomplished (e.g. the communication problem).

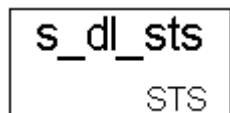

**Note:** S\_DL\_RST can be called to reset the status to -1 (reset to "No action")

**Example:** demo\_40, demo\_41, demo\_42, demo\_44  
Please refer to Section 10.3.

## S\_FL\_AVL

■ I-8x17/iP-8x17 ■ I-8x37/iP-8x47 ■ I-7188EG/7186EG ■ I-7188XG  
□ ISaGRAF WinCE PAC

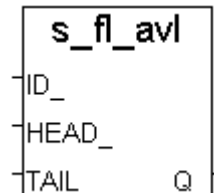

### Description : C\_Function

Set one file's current available byte No. for the volatile SRAM

### Input Parameters :

<b>ID_</b>	Integer	File identifier No. (1 ~ 8)
<b>HEAD_</b>	Integer	The current available starting byte No.
<b>TAIL_</b>	Integer	The current available ending byte No.

(HEAD\_, TAIL\_) must resides inside the area of the associate file (Please refer to "S\_FL\_INI"), or Q\_ will return FALSE

S256: 1 - 249856 (1 - 16#3D000)

S512: 1 - 512000 (1 - 16#7D000)

X607: 1 - 118784 (1 - 16#1D000)

X608: 1 - 512000 (1 - 16#7D000)

Ex:

A file with ID\_ = 1 resides at byte number of 1 ~ 20000, it can store up to 20000 bytes.

1. If setting one of HEAD\_ or TAIL\_ to -1, it means no data of the file is available. When you load this file from PC, its size is 0 byte.
2. If setting HEAD\_=1, TAIL\_=1000, the current available data of the file will be at 1 ~ 1000 inside the volatile SRAM. It means when you load this file from PC, its size is 1000 bytes.
3. If setting HEAD\_=10001, TAIL\_=5000, the current available data of the file will be at 10001 ~ 20000 and then continued with 1 ~ 5000 inside the volatile SRAM. It means when you load this file from PC, its size is 15000 bytes.
4. If setting HEAD\_=1000, TAIL\_=1000, it means no data of the file is available. When you load this file from PC, its size is 0 byte.

### Return :

**Q\_** Boolean TRUE: ok, FALSE: fail.

**Note:** S\_FL\_INI should be called once before S\_FL\_AVL is called

**Example :** demo\_40, demo\_41, demo\_42, demo\_44, demo\_71 (Chapter 11.3.7)  
Please refer to Chapter 10.3.

## S\_FL\_INI

■ I-8x17/iP-8x17 ■ I-8x37/iP-8x47 ■ I-7188EG/7186EG ■ I-7188XG □ ISaGRAF WinCE PAC

### Description : C\_Function

Initiate one file's name & location for the volatile SRAM

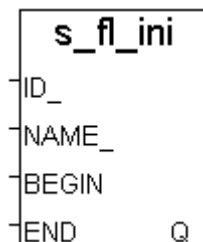

### Input Parameters :

**ID\_** Integer File identifier No. (1 ~ 8)  
**NAME\_** Message File name; Max. 8 char.(for name) + Max. 3 char.(for extension).

Valid char. are A ~ Z, a ~ z, \_ , 0 ~ 9, and the 1st should be A ~ Z or a ~ z. Ex: "data1.txt", "A1234567.bin".

**BEGIN\_** Integer The begin byte No. of the file. BEGIN\_ must less than END\_.

**END\_** Integer The end byte No. of the file. BEGIN\_ must less than END\_.

S256: 1 ~ 249,856

S512: 1 ~ 512,000

X607: 1 ~ 118,784

X608: 1 ~ 512,000

Ex, BEGIN\_=101, END\_=5000 :

the file resides at 101 ~ 5000 inside the SRAM.

### Return:

**Q\_** Boolean TRUE: ok, FALSE: fail

## S\_FL\_RST

■ I-8x17/iP-8x17 ■ I-8x37/iP-8x47 ■ I-7188EG/7186EG ■ I-7188XG □ ISaGRAF WinCE PAC

### Description : C\_Function

Reset the status of file to "Not been load by PC yet" for the volatile SRAM.

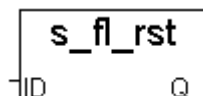

### Input Parameters:

**ID\_** Integer File identifier No. (1 ~ 8)

### Return:

**Q\_** Boolean TRUE: ok, FALSE: fail

### Note:

1. S\_FL\_INI should be called first.
2. S\_FL\_RST can be called to reset the status to -1 (reset to "Not been load by PC yet").

**Example :** demo\_40, demo\_41, demo\_42, demo\_44, demo\_71 (Chapter 11.3.7)

Please refer to Chapter 10.3.

## S\_FL\_STS

■ I-8x17/iP-8x17 ■ I-8x37/iP-8x47 ■ I-7188EG/7186EG ■ I-7188XG □ ISaGRAF WinCE PAC

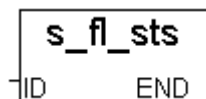

### Description : C\_Function

Get file's status and the end byte No. that has been load by PC for the volatile SRAM.

### Input Parameters:

**ID\_** Integer File identifier No. (1 ~ 8)

### Return:

**END\_** Integer The end byte No. that has been load by PC  
Not been load: -1  
S256: 1 ~ 249,856  
S512: 1 ~ 512,000  
X607: 1 ~ 118,784  
X608: 1 ~ 512,000

For ex.,

A file with ID\_ = 1 is located at byte No.: 1 ~ 20000, it can store up to 20000 bytes. And its current available data is setting at 1001 ~ 10000 inside the volatile SRAM.

1. If returned END\_ is -1, it means PC hasn't loaded the data yet.
2. If returned END\_ is 10000 (Normally the value is equal to the current available ending byte No.), it means PC has loaded the data from 1001 ~ 10000.
3. If returned END\_ is 8000, it means PC has loaded data from 1001 ~ 8000.

### Note:

1. S\_FL\_INI should be called first.
2. S\_FL\_RST can be called to reset the status to -1 (reset to "PC hasn't load it yet")

**Example :** demo\_40, demo\_41, demo\_42, demo\_44, demo\_71 (Chapter 11.3.7)  
Please refer to Section 10.3.

## S\_M\_R

■ I-8x17/iP-8x17 ■ I-8x37/iP-8x47 ■ I-7188EG/7186EG ■ I-7188XG □ ISaGRAF WinCE PAC

### Description : C\_Function

Read one String from the volatile backup SRAM

#### Input Parameters:

<b>ADR_</b>	Integer	The address to read from S256: 1 ~ 249,856 (1 ~ 16#3D000) S512: 1 ~ 512,000 (1 ~ 16#7D000) X607: 1 ~ 118,784 (1 ~ 16#1D000) X608: 1 ~ 512,000 (1 ~ 16#7D000)
<b>LEN_</b>	Integer	Max length of the String to read, 0 ~ 255

#### Return:

<b>STR_</b>	Message	The String been read
-------------	---------	----------------------

**Ex:** If the data inside the SRAM are 16#31, 16#32, 16#33, 16#34, 16#35, 0, 16#37, 16#38, ...

LEN_=0	---->	STR_= " (Null string)
LEN_=3	---->	STR_= '123'
LEN_=5	---->	STR_= '12345'
LEN_=6	---->	STR_= '12345'
LEN_=7	---->	STR_= '12345'
LEN_=100	---->	STR_= '12345'

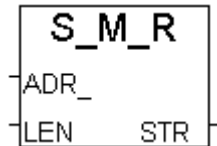

## S\_M\_W

■ I-8x17/iP-8x17 ■ I-8x37/iP-8x47 ■ I-7188EG/7186EG ■ I-7188XG □ ISaGRAF WinCE PAC

### Description : C\_Function

Write one String to the volatile backup SRAM

#### Input Parameters:

<b>ADR_</b>	Integer	The address to write from. S256: 1 ~ 249,856 (1 ~ 16#3D000) S512: 1 ~ 512,000 (1 ~ 16#7D000) X607: 1 ~ 118,784 (1 ~ 16#1D000) X608: 1 ~ 512,000 (1 ~ 16#7D000)
<b>LEN_</b>	Integer	The length of the String to write, 0 ~ 255
<b>STR_</b>	Message	The string to write.

#### Example:

LEN_=0 , STR='12345'	---->	No data can be write into
LEN_=1 , STR='12345'	---->	16#31 (write 1 byte)
LEN_=3 , STR='12345'	---->	16#31, 16#32, 16#33 (write 3 bytes)
LEN_=7 , STR='12345'	---->	16#31, 16#32, 16#33, 16#34, 16#35, 0, 0 (write 7 bytes)
LEN_=100 , STR='12345'	-->	16#31, 16#32, 16#33, 16#34, 16#35, 0, 0, 0, ... (write 100 bytes)

#### Return :

<b>Q_</b>	Boolean	Ok: TRUE, Fail: FALSE
-----------	---------	-----------------------

**Example :** demo\_40, demo\_41, demo\_42, demo\_44, demo\_71 (Chapter 11.3.7)  
Please refer to Section 10.3.

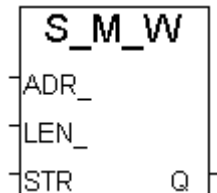

## S\_MB\_ADR

■ I-8x17/iP-8x17 ■ I-8x37/iP-8x47 ■ I-7188EG/7186EG ■ I-7188XG □ ISaGRAF WinCE PAC

### Description : C\_Function

Assign Modbus network address to "Variable Array" (refer to Sec.2.6.1)



### Target:

Target 1: I-8417/8817/8437/8837, I-7188EG, I-7188XG

Target 2: Wincon-8xx7

### Input Parameters:

<b>ADDR_</b>	Integer	The beginning Modbus Network Address No. which is assigned to this "Variable Array" in the dictionary windows. Target 1: 1~4095; Target 2: 1~8191.
<b>AMOUNT_</b>	Integer	The size of the "Variable Array". Valid range: 1~255. Ex: CNT[0..15] has size of 16, ABC[0..7] has size of 8.
<b>INTERVAL_</b>	Integer	0 : sequence Modbus address (e.g. 10, 11, 12, 13 ...) 1 : sequence odd/even Modbus address (ex. 4, 6, 8 ... or 1, 3, 5, 7 ...)

### Return:

<b>Q_</b>	Boolean	True: Ok; False: ADDR_ or AMOUNT_ or INTERVAL_ is error.
-----------	---------	--

### Note:

- This function should be called in the **1st** PLC scan cycle. It doesn't work in other PLC scan cycle.
- The beginning Modbus Network Address of the "Variable Array" should be assigned in the ISaGRAF Dictionary windows. For example, assign Network address No. = 21 to "Variable Array" of L[0..9]
- To declare a "Variable Array" for ISaGRAF version 3.4 (or 3.5), please edit the "isa.ini" file in the ISaGRAF sub-directory "C:\ISAWIN\EXE\". And then when you open the ISaGRAF workbench, there will be a "DIM" area in the Dictionary Declaration Windows for you to assign the size of the "variable array".  
Edit c:\isawin\exe\isa.ini file, add these 2 lines at the very beginning of the file content:  
[DEBUG]  
arrays=1
- To view or control the value of "Variable array" when debug for the controller program, please use "Spy list" and insert the array variable name. For example, insert L[0], L[1]. Please refer to Chapter 9.12 of the "User's Manual of ISaGRAF PAC" for "Spy list"
- Please declare and use "Variable Array" carefully. Don't declare the size too large, just declare the size you need, or it will consume lots of memory. And DON'T use the index that bigger than you declare. For example, if you declare **CNT[0..9]**, DO NOT use as below, or the program will have error at run time.  
For index := **0 to 10** do  
  A := A + CNT[index] ;  
End\_For ;  
(\* the **CNT[10]** **doesn't** exist in this example \*)
- Please assign the Modbus Network address carefully, do not conflict with other variables.
- For more information about 'Redundancy' & 'Variable Array' of controller, please refer to the manual or website listed below.
  - Wincon-8xx7 CD-ROM: \napdos\isagraf\wincon\english\_manu\
  - ftp://ftp.icpdas.com/pub/cd/wincon\_isagraf/napdos/isagraf/wincon/english\_manu/



## S\_MV

■ I-8x17/iP-8x17 ■ I-8x37/iP-8x47 ■ I-7188EG/7186EG ■ I-7188XG □ ISaGRAF WinCE PAC

### Description : C\_Function

Copy some Bytes inside the volatile SRAM .

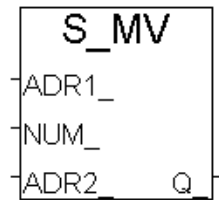

### Input Parameters :

**ADR1\_** Integer The starting position of the destination  
S256: 1 - 249856 (1 - 16#3D000)  
S512: 1 - 512000 (1 - 16#7D000)  
X607: 1 - 118784 (1 - 16#1D000)  
X608: 1 - 512000 (1 - 16#7D000)

**NUM\_** Integer How many Bytes to copy, 0~512,000

**ADR2\_** Integer The starting position to copy from

### Return :

**Q\_** Boolean Ok: TRUE; fail: FALSE.

## S\_N\_R

■ I-8x17/iP-8x17 ■ I-8x37/iP-8x47 ■ I-7188EG/7186EG ■ I-7188XG □ ISaGRAF WinCE PAC

### Description : C\_Function

Read one Integer from the volatile SRAM

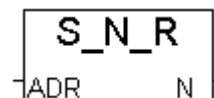

### Input Parameters :

**ADR\_** Integer The starting position to read from, one Integer occupy 4 bytes.  
S256: 1 ~ 249,856 (1 ~ 16#3D000)  
S512: 1 ~ 512,000 (1 ~ 16#7D000)  
X607: 1 ~ 118,784 (1 ~ 16#1D000)  
X608: 1 ~ 512,000 (1 ~ 16#7D000)

### Return :

**N\_** Integer The Integer been read

**Note :** The integer written in the SRAM is [Lowest byte] [2nd byte] [3rd byte] [High byte].  
Ex: An integer of 16#01020304 will be saved in the SRAM as [04] [03] [02] [01].

## S\_N\_W

■ I-8x17/iP-8x17 ■ I-8x37/iP-8x47 ■ I-7188EG/7186EG ■ I-7188XG  
□ ISaGRAF WinCE PAC

### Description : C\_Function

Write one Integer to the volatile SRAM

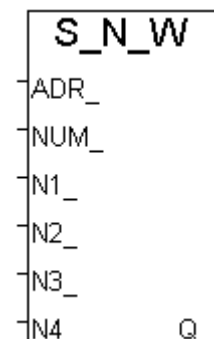

### Input Parameters :

**ADR\_** Integer The starting position to write, one Integer occupy 4 bytes.  
S256: 1 ~ 249,856 (1 ~ 16#3D000)  
S512: 1 ~ 512,000 (1 ~ 16#7D000)  
X607: 1 ~ 118,784 (1 ~ 16#1D000)  
X608: 1 ~ 512,000 (1 ~ 16#7D000)

**NUM\_** Integer How many Integers to write, 0 ~ 4

**N1\_~N4\_** Integer The Integer value (32-bit, signed) to write

**Note :** The Integer written in the SRAM is [Lowest byte] [2nd byte] [3rd byte] [High byte].  
Ex: An Integer of 16#01020304 will be saved in the SRAM as [04] [03] [02] [01].

### Return :

**Q\_** Boolean Ok: TRUE; fail: FALSE.

## S\_R\_R

■ I-8x17/iP-8x17 ■ I-8x37/iP-8x47 ■ I-7188EG/7186EG ■ I-7188XG □ ISaGRAF WinCE PAC

### Description : C\_Function

Read one Real value from the volatile SRAM

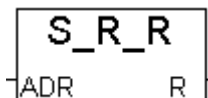

### Input Parameters :

**ADR\_** Integer The address to read, one Real value occupy 4 bytes.  
S256: 1 ~ 249,856 (1 ~ 16#3D000)  
S512: 1 ~ 512,000 (1 ~ 16#7D000)  
X607: 1 ~ 118,784 (1 ~ 16#1D000)  
X608: 1 ~ 512,000 (1 ~ 16#7D000)

### Return :

**R\_** Real the Real value been read (32-bit float)

### Note :

1. The Real value written in the SRAM is [Lowest byte] [2nd byte] [3rd byte] [High byte].  
Ex: Real Value of 1.23 is consists of 4 bytes --> 16#A4 , 16#70 , 16#9D , 16#3F
2. If the data stored in the volatile SRAM is not Real type but use the S\_R\_R to read, it may cause Local Fault No.102. (please refer to Section 10.6)

## S\_R\_W

■ I-8x17/iP-8x17 ■ I-8x37/iP-8x47 ■ I-7188EG/7186EG ■ I-7188XG  
□ ISaGRAF WinCE PAC

### Description : C\_Function

Write one Real value to the volatile SRAM

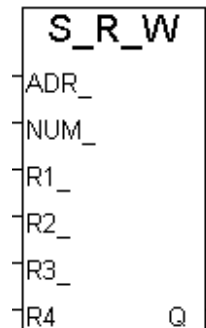

### Input Parameters :

**ADR\_** Integer The starting position to write, one Real value occupy 4 bytes.  
S256: 1 ~ 249,856 (1 ~ 16#3D000)  
S512: 1 ~ 512,000 (1 ~ 16#7D000)  
X607: 1 ~ 118,784 (1 ~ 16#1D000)  
X608: 1 ~ 512,000 (1 ~ 16#7D000)

**NUM\_** Integer How many Real to write, 0 ~ 4

**R1\_~R4\_** Real The Real value to write

**Note :** The Real value written in the SRAM is [Lowest byte] [2nd byte] [3rd byte] [High byte].  
Ex: Real Value of 1.23 is consists of 4 bytes --> 16#A4 , 16#70 , 16#9D , 16#3F

### Return :

**Q\_** Boolean Ok: TRUE, fail: FALSE

## S\_WD\_R

■ I-8x17/iP-8x17 ■ I-8x37/iP-8x47 ■ I-7188EG/7186EG ■ I-7188XG □ ISaGRAF WinCE PAC

### Description : C\_Function

Read one Word value from the volatile SRAM

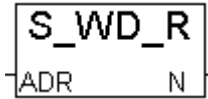

### Input Parameters :

**ADR\_** Integer The address to read, one Word value occupy 2 bytes.  
S256: 1 ~ 249,856 (1 ~ 16#3D000)  
S512: 1 ~ 512,000 (1 ~ 16#7D000)  
X607: 1 ~ 118,784 (1 ~ 16#1D000)  
X608: 1 ~ 512,000 (1 ~ 16#7D000)

### Return :

**N\_** Integer The Word value been read, -32768 ~ +32767

**Note:** The Word value written in the SRAM is [Low byte] [High byte].  
Ex: Word Value of 16#0102 is consists of [02] [01]

## S\_WD\_W

■ I-8x17/iP-8x17 ■ I-8x37/iP-8x47 ■ I-7188EG/7186EG ■ I-7188XG  
□ ISaGRAF WinCE PAC

### Description : C\_Function

Write one Word value to the volatile SRAM

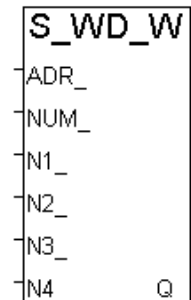

### Input Parameters :

**ADR\_** Integer The starting position to write, one Word value occupy 2 bytes.  
S256: 1 ~ 249,856 (1 ~ 16#3D000)  
S512: 1 ~ 512,000 (1 ~ 16#7D000)  
X607: 1 ~ 118,784 (1 ~ 16#1D000)  
X608: 1 ~ 512,000 (1 ~ 16#7D000)

**NUM\_** Integer How many Words to wrote, 0 ~ 4

**N1\_~N4\_** Integer The Word value to write, -32768 ~ 32767

**Note:** The Word value written in the SRAM is [Low byte] [High byte].  
Ex: Word Value of 16#0102 is consists of 2 bytes --> [02] [01]

### Return :

**Q\_** Boolean Ok: TRUE, fail: FALSE

## SET\_LED

■ I-8x17/iP-8x17 ■ I-8x37/iP-8x47 ■ I-7188EG/7186EG ■ I-7188XG □ ISaGRAF WinCE PAC

### Description : C\_Function

Display Message to the S-MMI controller

### Input Parameters :

<b>RUN_</b>	Boolean	TRUE: display; FALSE: not display.
<b>FLASH_</b>	Integer	Set 1 for related position to flash.
	Ex:	Set to 11 (000011), the position 6 & 7 will blink.
		Set to 100001 (0100001), the position 2 & 7 will blink.
<b>CLK_</b>	Timer	The blinking period in ms, if < 50ms will act like 50ms
<b>LED1_</b>	Integer	The Message to display in position 1
<b>LED2_</b>	Integer	The Message to display in position 2
<b>LED3_</b>	Integer	The Message to display in position 3
<b>LED4_</b>	Integer	The Message to display in position 4
<b>LED5_</b>	Integer	The Message to display in position 5
<b>LED6_</b>	Boolean	To display position 6 if TRUE
<b>LED7_</b>	Boolean	To display position 7 if TRUE

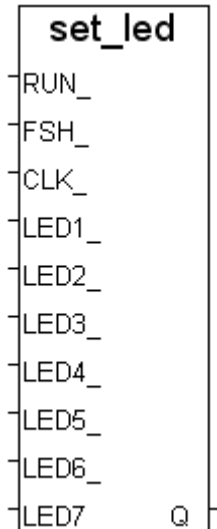

### Return :

**Q\_** Boolean Always true, no meaning.

\* Please refer to appendix A.3 for the symbol table.

### Example

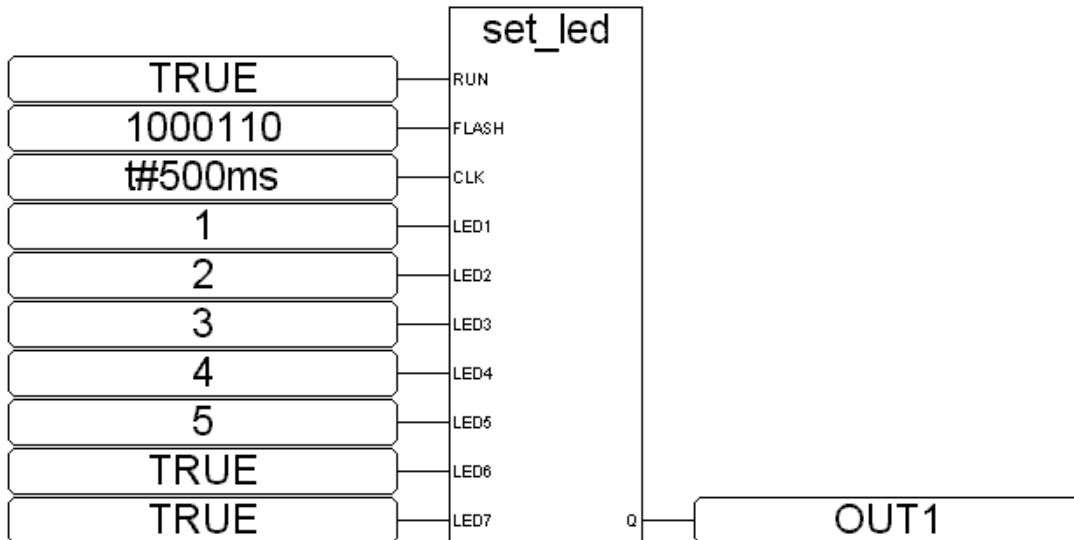

### ST Equivalence:

```
TMP := SET_LED(TRUE,1000110,t#500ms,1,2,3,4,5,TRUE,TRUE);
(* TMP should be declared as Boolean variable *)
```

## SETRTS

□ I-8x17/iP-8x17 □ I-8x37/iP-8x47 ■ I-7188EG/7186EG ■ I-7188XG □ ISaGRAF WinCE PAC

### Description : C\_Function

Set the RTS of COM PORT, available for COM number: 3 ~ 5

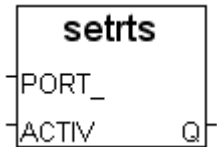

### Input Parameters:

PORT\_ Integer The COM to set RTS. 3:COM3, 4:COM4, 5:COM5  
ACTIVE\_ Boolean TRUE: set RTS active; FALSE: set RTS inactive

### Return :

Q\_ Boolean TRUE: OK, FALSE: fail

## SMS\_GET

■ I-8x17/iP-8x17 ■ I-8x37/iP-8x47 ■ I-7188EG/7186EG ■ I-7188XG  
■ ISaGRAF WinCE PAC

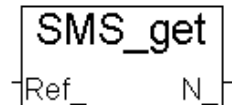

### Description : C\_Function

Get Message date and time from controller's date & time (Refer to Chapter 17)

### Input Parameters :

REF\_ Integer What to get? 1 ~ 7  
1: year, ( N\_ = 2000 ~ 2099 )  
2: month, ( N\_ = 1 ~ 12 )  
3: day, ( N\_ = 1 ~ 31 )  
4: week day, ( N\_ = 1 ~ 7, 7 means Sunday. )  
5: time, ( N\_ = 0 ~ 23 )  
6: minute, ( N\_ = 0 ~ 59 )  
7: second, ( N\_ = 0 ~ 59 )  
Others: return N\_ = -1 (means error)

### Return :

N\_ Integer Return associated data with Ref\_.  
If return -1, it may be "No message" or Ref\_ out of range of 1 ~ 7.

## SMS\_GETS

■ I-8x17/iP-8x17 ■ I-8x37/iP-8x47 ■ I-7188EG/7186EG ■ I-7188XG  
■ ISaGRAF WinCE PAC

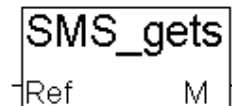

### Description : C\_Function

Get Message data and other information (Refer to Chapter 17)

### Input Parameters :

REF\_ Integer What to get? 1 ~ 3  
1: message data  
2: get phone No. of sender  
3: get date & time in string format  
Others: return M\_ = 'error'

**Return :**

**M\_** Message Return associated data with Ref\_. If return 'error', it may be "No message" or Ref\_ out of range of 1 ~ 3.

**Note:**

1. SMS\_gets & SMS\_get can be called to get Message and the related information.
2. After SMS\_gets(1) is called (get message data), the message buffer will reset to "No message". So if the other information are need, please call SMS\_get(1~7) & SMS\_gets(2) & SMS\_gets(3) before calling SMS\_gets(1).

**Example:** demo\_43, demo\_43a

**SMS\_SEND**

- I-8x17/iP-8x17 ■ I-8x37/iP-8x47 ■ I-7188EG/7186EG ■ I-7188XG
- ISaGRAF WinCE PAC

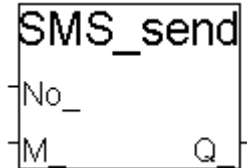

**Description : C\_Function**

Trigger the controller to send a new Message (Refer to Chapter 17)

**Input Parameters :**

**No\_** Message To which phone No. Ex. '+886920119135', max length is 31 digits  
**M\_** Message The Message content to send

**Return :**

**Q\_** Boolean True: ok; False: wrong phone number or fail to send.

**SMS\_STS**

- I-8x17/iP-8x17 ■ I-8x37/iP-8x47 ■ I-7188EG/7186EG ■ I-7188XG
- ISaGRAF WinCE PAC

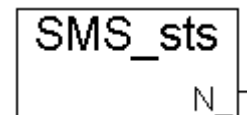

**Description : C\_Function**

Get Message Sending status. (Refer to Chapter 17)

**Return :**

**N\_** Integer The sending status code  
0 : Waiting for a new sending request  
1 : Busy. (One message is processing now)  
21: The message is sent successfully  
-1 : SMS system is not available (Check GSM Modem & SIM card)  
-2 : Timeout, no response. (It May be no such a phone No.)

**Note:**

1. Please call SMS\_sts to get the "Message Sending status" before calling SMS\_send. SMS\_send only works when status is not "1:busy".
2. A successfully SMS\_send request will reset the "Message sending status" to "1:busy", and after that, by the time, it will set to the associate status. For ex. "21:successfully sent".

**Example:** demo\_43, demo\_43a

## SMS\_TEST

- I-8x17/iP-8x17 ■ I-8x37/iP-8x47 ■ I-7188EG/7186EG ■ I-7188XG
- ISaGRAF WinCE PAC

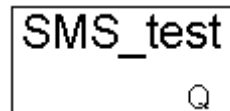

### Description : C\_Function

Test if message coming or not (Please refer to Chapter 17)

### Return :

**Q\_** Boolean TRUE: A message is coming, FALSE: no message

### Note:

1. SMS\_gets & SMS\_get can be called to get message
2. After SMS\_gets(1) is called (get message data), the message buffer will reset to "No message". So if the message's related information are need, please call SMS\_get(1~7) & SMS\_gets(2) & SMS\_gets(3) before calling SMS\_gets(1)

**Example :** demo\_43 , demo\_43a

## STR\_REAL

- I-8x17/iP-8x17 ■ I-8x37/iP-8x47 ■ I-7188EG/7186EG ■ I-7188XG ■ ISaGRAF WinCE PAC



### Description : C\_Function

Convert a string to a Real value

### Input Parameters :

**STR\_** Message The String to convert, Ex: '-0.2345' , ' +2.13E10' , ' 15.2345E-2'

### Return :

**REAL\_** Real The Real value after conversion  
If it returns "1.23E-20", it means the setting for STR\_ is wrong.  
Ex: If STR\_ = ' 123.AB' or '23-45.17' or '1.2.345',  
REAL\_ will return 1.23E-20.

### Note:

"REAL\_STR" & "REA\_STR2" could be called to convert Real value to String.

**Example:** Please refer to Chapter 16 & demo\_38, demo\_39



## SYSDAT\_R

- I-8x17/iP-8x17 ■ I-8x37/iP-8x47 ■ I-7188EG/7186EG ■ I-7188XG
- ISaGRAF WinCE PAC

### Description : C\_Function Block

Read system year, month, day and date

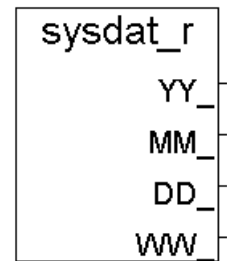

### Return :

<b>YY_</b>	Integer	Year, e.g. 2002, 2003, 2010
<b>MM_</b>	Integer	Month, 1 ~ 12
<b>DD_</b>	Integer	Date in month, 1 ~ 31
<b>WW_</b>	Integer	Day of week, 1 ~ 7, 7 indicate Sunday, etc.

**Example:** Please refer to demo\_03.

Y1, M1, D1 & W1 are declared as Integer variables.

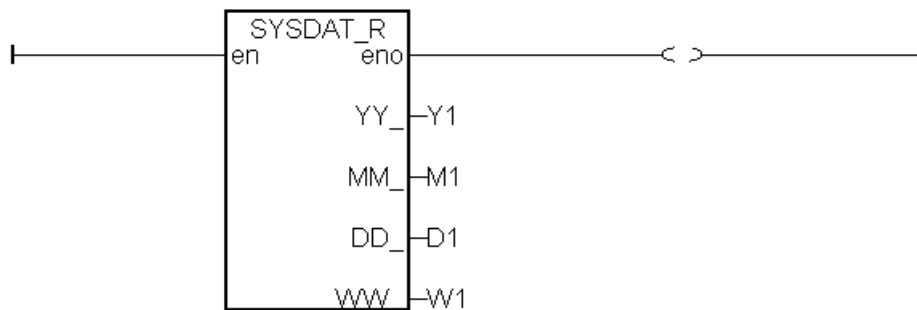

### ST Equivalence:

```
DAT_R1(); (* call DAT_R1 *)
Y1 := DAT_R1.YY_; (* get year *)
M1 := DAT_R1.MM_; (* get month *)
D1 := DAT_R1.DD_; (* get date *)
W1 := DAT_R1.WW_; (* get day of week *)
(*DAT_R1 is declared as FB instance of SYSDAT_R *)
```

## SYSDAT\_W

- I-8x17/iP-8x17
- I-8x37/iP-8x47
- I-7188EG/7186EG
- I-7188XG
- ISaGRAF WinCE PAC

### Description : C\_Function Block

Set new system year, month and day

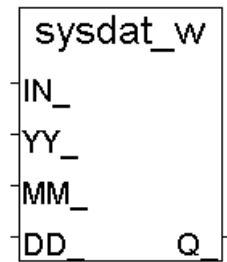

### Input Parameters:

<b>IN_</b>	Boolean	Set new system date when rising from FALSE to TRUE
<b>YY_</b>	Integer	Year, e.g. 2002, 2003, 2010
<b>MM_</b>	Integer	Month, 1 ~ 12
<b>DD_</b>	Integer	Date, 1 ~ 31

### Return :

<b>Q_</b>	Boolean	Ok returns TRUE
-----------	---------	-----------------

**Example:** Please refer to demo\_03.

SW1 is declared as Boolean variable. Y1, M1 & D1 are declared as Integer variable.

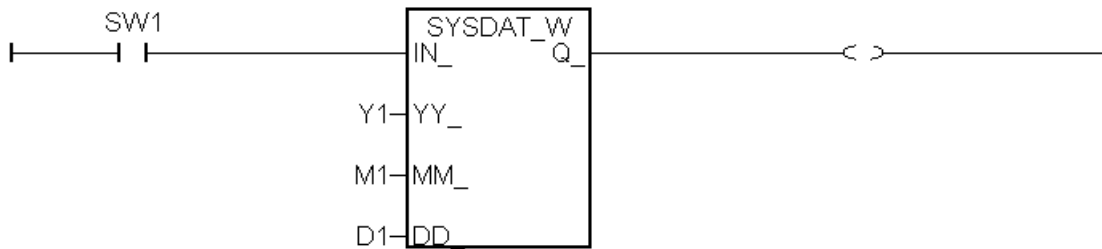

### ST Equivalence:

```
DAT_W1( SW1, Y1, M1, D1);      (* call DAT_W1 *)
OUT1 := DAT_W1.Q_ ;          (* get return value Q_ *)
(* DAT_W1 is declared as FB instance of SYSDAT_W*)
(* OUT1 is declared as Boolean variable*)
```

## SYSTIM\_R

- I-8x17/iP-8x17
- I-8x37/iP-8x47
- I-7188EG/7186EG
- I-7188XG
- ISaGRAF WinCE PAC

### Description : C\_Function Block

Read system hour, minute and second.

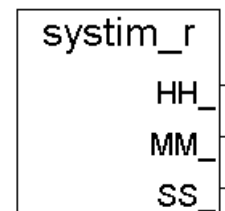

### Return :

<b>HH_</b>	Integer	Hour, 0 ~ 23
<b>MM_</b>	Integer	Minute, 0 ~ 59
<b>SS_</b>	Integer	Second, 0 ~ 59

**Example:** Please refer to demo\_03 & demo\_15b.

H1, M1 & S1 are declared as Integer variables.

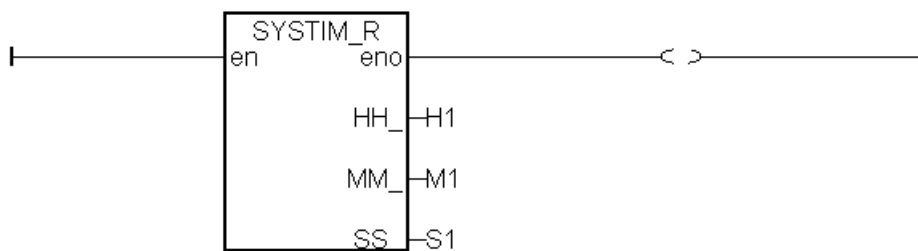

### ST Equivalence:

```
(* TIM_R1 is declared as FB instance SYSTIM_R*)
TIM_R1( );                               (* call TIM_R1 *)
H1 := TIM_R1.HH_ ;                       (* get hour *)
M1 := TIM_R1.MM_ ;                       (* get minute *)
S1 := TIM_R1.SS_ ;                       (* get second *)
```

## SYSTM\_W

- I-8x17/iP-8x17
- I-8x37/iP-8x47
- I-7188EG/7186EG
- I-7188XG
- ISaGRAF WinCE PAC

### Description : C\_Function Block

Set new system hour, minute and second.

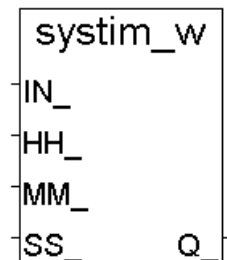

### Input Parameters :

- |            |         |  |
|------------|---------|--|
| <b>IN_</b> | Boolean | Set new system time when rising from FALSE to TRUE |
| <b>HH_</b> | Integer | Hour, 0 ~ 23                                       |
| <b>MM_</b> | Integer | Minute, 0 ~ 59                                     |
| <b>SS_</b> | Integer | Second, 0 ~ 59                                     |

### Return :

- |           |         |                    |
|-----------|---------|--------------------|
| <b>Q_</b> | Boolean | If OK returns TRUE |
|-----------|---------|--------------------|

**Example:** Please refer to demo\_03.

SW1 is declared as Boolean variable. H1, M1 & S1 are declared as Integer variable.

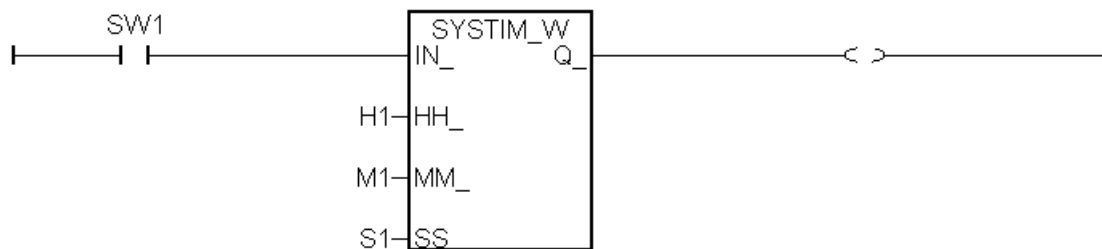

### ST Equivalence:

```
TIM_W1( Sw1,2000,7,5);      (* call TIM_W1 *)
OUT1 := TIM_W1.Q_ ;        (* get the returned value Q_ *)
(* TIM_W1 is declared as FB instance of SYSTM_W*)
(* OUT1 is declared as Boolean variable*)
```

## TCP\_RECV

□ I-8x17/iP-8x17 □ I-8x37/iP-8x47 □ I-7188EG/7186EG □ I-7188XG ■ ISaGRAF WinCE PAC

### Description : C\_Function

TCP Client receive message from remote PC or device's TCP/IP server (via Ethernet) (Please refer to Section 19.3)

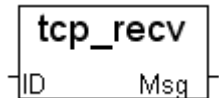

### Input Parameters :

**ID\_** Integer The related "Tcp\_Clie" connecting number, 1 ~ 4.  
The related "ip address" and "port No." is defined in IO connection: "Tcp\_clie".

### Return :

**MSG\_** Message The received Message.  
If Msg\_ = " (empty Message), it means no Message coming.

### Note :

1. Please connect "tcp\_clie" (TCP\_Client) in the IO connection windows before using "tcp\_recv" & "tcp\_send"
2. The receiving buffer size is 4096 bytes. If the receiving buffer is full, the oldest message will be dropped to release space for receiving new coming data.

**Example :** Wpdmo\_33 & Wpdmo\_34 (WP-8xx7 CD\_ROM:\napdos\isagraf\wp-8xx7\demo\)

## TCP\_SEND

□ I-8x17/iP-8x17 □ I-8x37/iP-8x47 □ I-7188EG □ I-7188XG  
■ ISaGRAF WinCE PAC (ver 3.30)

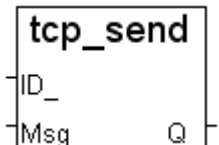

### Description : C\_Function

TCP Client send Message to remote PCs or device's TCP/IP server (via Ethernet) (Please refer to Section 19.3)

### Input Parameters :

**ID\_** Integer The related "Tcp\_Clie" connecting number, 1 ~ 4.  
The related "ip address" and "port No." is defined in IO connection: "Tcp\_clie".

**Msg\_** Message The message to send

### Return :

**Q\_** Boolean True: send OK; False: parameter error (Ex, set ID\_ to 8) or the setting of the related "Tcp\_Clie" connection in IO connection window is error.

### Note :

1. Please connect "tcp\_clie" (TCP\_Client) in the IO connection windows before using "tcp\_recv" & "tcp\_send"
2. The sending buffer for Wincon is 4096 bytes. That means max. 4096 bytes in one PLC scan can be sent to remote IP. If sending buffer is full, the oldest message will be dropped to release space for new "tcp\_send( )" request.
3. The controller driver will send only one message out each PLC scan when there is message in the sending buffer. For example, if there are 100 messages in the sending buffer, the controller will send over these 100 messages in 100 PLC scan cycle. However if set "Send\_Time\_Gap" of "Tcp\_clie" to a larger value, for example 100 (ms), each message will be sent out one by one every 100 ms later.

**Example:** Wpdmo\_33 & Wpdmo\_34 (WP-8xx7 CD\_ROM:\napdos\isagraf\wp-8xx7\demo\)

## TIME\_STR

■ I-8x17/iP-8x17 ■ I-8x37/iP-8x47 ■ I-7188EG/7186EG ■ I-7188XG ■ ISaGRAF WinCE PAC

### Description : C\_Function

Convert Date & Time to String format

#### Input Parameters :

<b>YEAR_</b>	Integer	Year, 2000 ~
<b>MON_</b>	Integer	Month, 1 ~ 12
<b>MDAY_</b>	Integer	Date, 1 ~ 31
<b>WDAY_</b>	Integer	Day of week, 1 ~ 7 (Monday ~ Sunday)
<b>HOUR_</b>	Integer	Hour, 0 ~ 23
<b>MIN_</b>	Integer	Minute, 0 ~ 59
<b>SEC_</b>	Integer	Second, 0 ~ 59

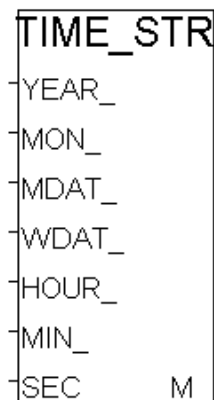

#### Return :

**M\_** Message Length is 24 Characters. Ex: 'Feb/18/2003,13:25:45,Tue'

#### Note:

1. Please use sysdat\_r & systim\_r to get date & time of the controller.
2. If giving wrong input parameters, it will returned M\_ = " (empty String). Ex: MON\_=14.

## TMR

■ I-8x17/iP-8x17 ■ I-8x37/iP-8x47 ■ I-7188EG/7186EG ■ I-7188XG ■ ISaGRAF WinCE PAC

### Description : Standard Function

Convert any Analog variable to a Timer one

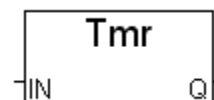

#### Input Parameters :

**IN\_** Int-Real Any non-timer value  
Only the Integer part of IN if it is a Real. Unit: millisecond.

#### Return :

**Q\_** Timer The Timer value of IN

**Example:** (\* FBD example with "Convert to Timer" blocks \*)

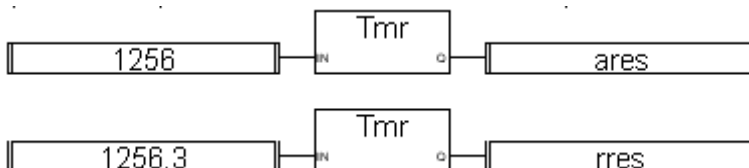

(\* ST equivalence: \*)

ares := TMR (1256); (\* ares := t#1s256ms \*)  
res := TMR (1256.3); (\* rres := t#1s256ms \*)

(\* IL equivalence: \*)

LD 1256  
TMR  
ST ares  
LD 1256.3  
TMR  
ST rres

## TO\_A4\_20

■ I-8x17/iP-8x17 ■ I-8x37/iP-8x47 ■ I-7188EG ■ I-7188XG ■ ISaGRAF WinCE P...

### Description : C\_Function

Convert User's Engineering Value ("Real" format) to Variable's AO value (Analog output signal is 4 to 20mA, Integer format)

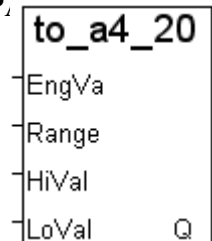

### Input Parameters :

<b>EngVal_</b>	Real	The Engineering value to be converted.
<b>Range_</b>	Integer	Range setting of the Analog output board or module. 16#0 : 0 ~ 20 mA 16#1 : 4 ~ 20 mA 16#30 : 0 ~ 20 mA 16#31 : 4 ~ 20 mA
<b>HiVal_</b>	Real	User's related High Eng. value when analog output signal is 20 mA
<b>LoVal_</b>	Real	User's related Low Eng. value when analog output signal is 4 mA

EX: Convert 0 - 100 psi to become I-8024's AO value, please set HiVal\_ = 100.0 , LoVal\_ = 0.0 & Range\_=16#30 (depends on the range setting of the related IO board).

### Return :

<b>Q_</b>	Integer	The AO value after conversion (value is usually in 0 to +32767, depends on which Range setting of the IO board). If given incorrect Range_ or (HiVal_ = LoVal_), returns -1.
-----------	---------	---

### Example :

1. Convert (0 - 100) psi to become (6554 - 32767) (if the range setting of the analog output board is 16#30 : 0 - 20mA)
2. Convert (0 - 100) psi to become (0 - 32767) (if the range setting of the analog output board is 16#31 : 4 - 20mA)
3. Scale ( 0 to 3000 rpm) to I-8024's current output with range setting of 30: (0 to 20 mA).  
0 rpm should output as 4 mA , 3000 rpm outputs as 20 mA.

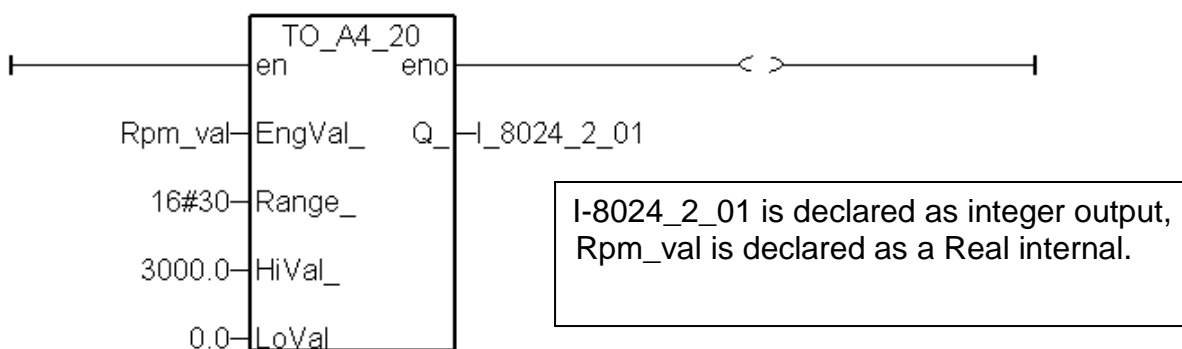

- Note:**
1. The related range setting of Analog output board or module should be set as mA range.  
Ex: (-20 , +20mA) , (0 , 20mA) , (4 , 20mA) ... mA
  2. When using A4\_20\_to, To\_A4\_20, To\_V0\_10, V0\_10\_to functions, user needs to upgrade the driver to the version listed below or latter version: i-7188EG: v2.16, i-7188XG: v2.14, i-8xx7:v3.18, so that the program can run well. (The older driver may cause the program cease after running a period of time.).

## TO\_V0\_10

■ I-8x17/iP-8x17 ■ I-8x37/iP-8x47 ■ I-7188EG/7186EG ■ I-7188XG ■ ISaGRAF WinCE PAC

### Description : C\_Function

Convert User's Engineering Value ("Real" format) to Variable's AO value (Analog output signal is 0 to 10V, Integer format)

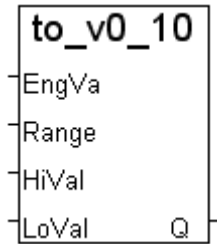

### Input Parameters :

<b>EngVal_</b>	Real	The Engineering value to be converted.
<b>Range_</b>	Integer	Range setting of the Analog output board or module. 16#2 : 0 ~ 10 V 16#32 : 0 ~ 10 V 16#33 : -10 ~ 10 V 16#34 : 0 ~ 5 V 16#35 : -5 ~ +5 V
<b>HiVal_</b>	Real	User's related High Eng. value when Analog output signal is 10 V
<b>LoVal_</b>	Real	User's related Low Eng. value when Analog output signal is 0 V

Ex: Convert 0 - 100 psi to become I-8024's AO value, please set HiVal\_ = 100.0 , LoVal\_ = 0.0 and Range\_=16#33 (depends on the range setting of the related IO board).

### Return :

<b>Q_</b>	Integer	The AO value after conversion Value is usually in (0 ~ +32767), depends on which Range setting of the IO board. If given incorrect Range_ or (HiVal_ = LoVal_ ) , returns -1.
-----------	---------	---

### Example :

1. Convert (0 - 100) psi to become (0 - 32767) (if the range setting of the analog output board is 16#32 : 0 ~ 10V)
2. Convert (0 - 100) psi to become (0 - 32767) (if the range setting of the analog output board is 16#33 : -10 ~ +10V)

Note: The related range setting of Analog output board or module should be set as Voltage range. for ex, (0 , 10 V) , (-10 , 10 V)

- Note:**
1. The related range setting of Analog output board or module should be set as Voltage range. E: (0 , 10 V) , (-10 , 10 V) etc.
  2. When using A4\_20\_to, To\_A4\_20, To\_V0\_10, V0\_10\_to functions, user needs to upgrade the driver to the version listed below or latter version: i-7188EG: v2.16, i-7188XG: v2.14, i-8xx7:v3.18, so that the program can run well. (The older driver may cause the program cease after running a period of time.).



# TOF

■ I-8x17/iP-8x17 ■ I-8x37/iP-8x47 ■ I-7188EG/7186EG ■ I-7188XG ■ ISaGRAF WinCE PAC

**Description : Standard Function**  
OFF-Delay control

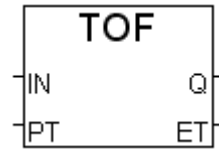

### Input Parameters :

<b>IN</b>	Boolean	To control the input of OFF-delay. If it's on the Rising edge, output Q to ON (set to TRUE). If it's on the Falling edge, start the ET OFF-delay timer.
<b>PT</b>	Timer	Setting of the delay time, When ET Timer count to the setting time of PT, Q will be OFF (set to False).

### Return :

<b>Q</b>	Boolean	Output
<b>ET</b>	Timer	The elapsed time since TOF was active.

### Timing Diagram: (OFF-delay)

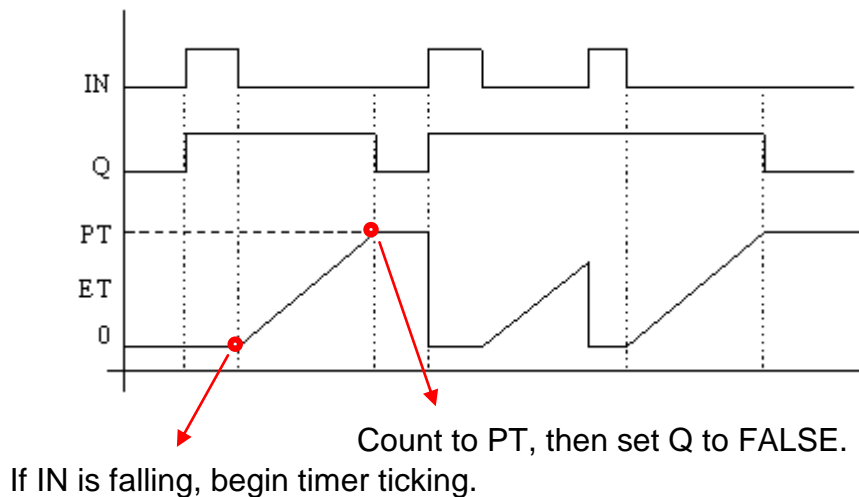

# TON

■ I-8x17/iP-8x17 ■ I-8x37/iP-8x47 ■ I-7188EG/7186EG ■ I-7188XG ■ ISaGRAF WinCE PAC

**Description : Standard Function**  
ON-Delay control

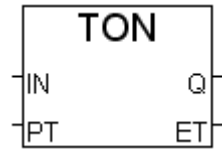

## Input Parameters :

<b>IN</b>	Boolean	To control the input of ON-delay. If it's on the Rising edge, start the ET ON-delay timer. If it's on the Falling edge, stop timer and set Q to FALSE.
<b>PT</b>	Timer	Set the delay time

## Return :

<b>Q</b>	Boolean	Output
<b>ET</b>	Timer	The elapsed time since TON was active

## Timing Diagram: (ON-delay)

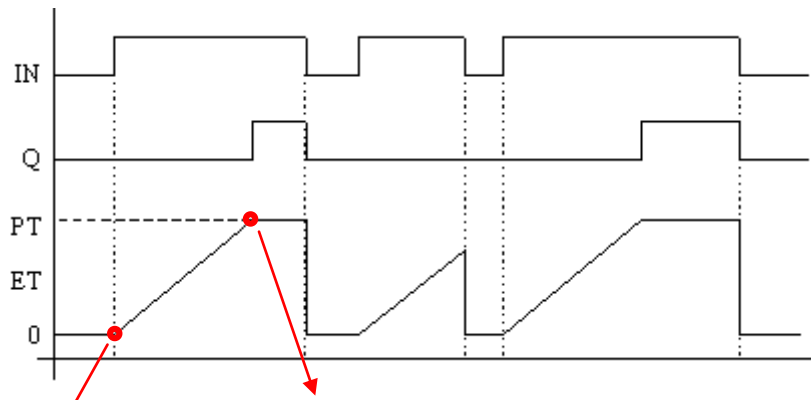

Count to PT, then set Q to TRUE.

If IN is Rising, begin timer ticking.

## TP

■ I-8x17/iP-8x17 ■ I-8x37/iP-8x47 ■ I-7188EG/7186EG ■ I-7188XG ■ ISaGRAF WinCE PAC

### Description : Standard Function

Set output to ON for an interval time (Pulse timer).



### Input Parameters :

<b>IN</b>	Boolean	To control the input of TP If IN is rising, output Q to ON and start ET timer. If IN is falling, stop the timer and reset the timer. <b>Note:</b> The rising / falling of IN is work only when Q is OFF, and the change of IN is not effect when the timer is active.
<b>PT</b>	Timer	Set the time interval (How long that Q will ON).

### Return :

<b>Q</b>	Boolean	Output
<b>ET</b>	Timer	The elapsed time since TP was active

### Timing Diagram: (Pulse Timer)

The change of IN is not effect when the timer is active.

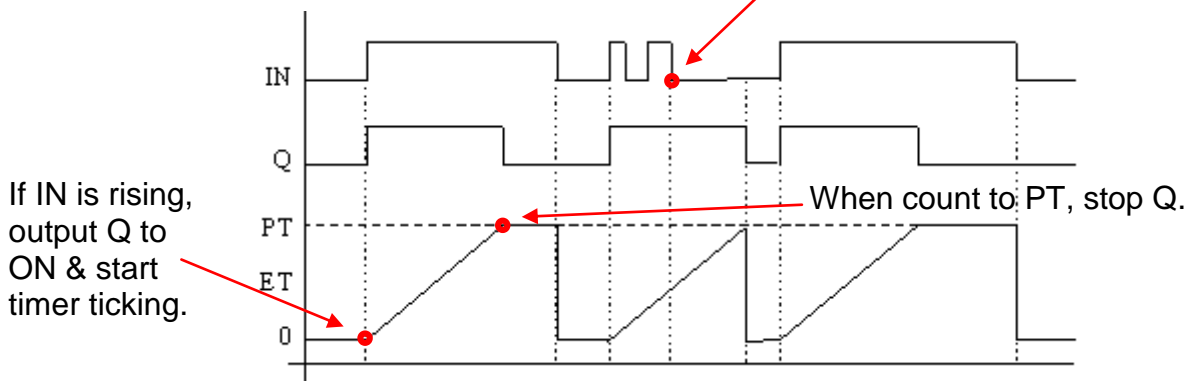

## TWIN\_LED

■ I-8x17/iP-8x17 ■ I-8x37/iP-8x47 ■ I-7188EG/7186EG ■ I-7188XG  
□ ISaGRAF WinCE PAC

### Description : C\_Function

Show 2 screen values to the S-MMI.

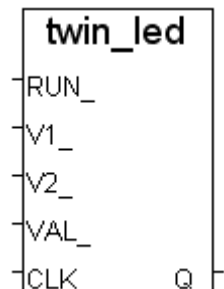

### Input Parameters :

<b>RUN_</b>	Boolean	To show only in RUN_ is TRUE.
<b>V1_</b>	Integer	The value displayed on the left 2 digits of the 1st screen, 0 ~ 99.
<b>V2_</b>	Integer	The value displayed on the right 2 digits of the 1st screen, 0 ~ 99.
<b>VAL_</b>	Integer	The value displayed on the 2nd screen, -99999 ~ 99999
<b>CLK_</b>	Timer	The blinking period of these 2 screens

### Return :

<b>Q_</b>	Boolean	Always TRUE
-----------	---------	-------------

**Example:** Please refer to demo\_10.

## UDP\_RECV

- I-8x17/iP-8x17 ■ I-8x37/iP-8x47 ■ I-7188EG/7186EG □ I-7188XG
- ISaGRAF WinCE PAC

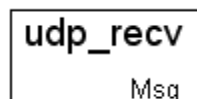

### Description : C\_Function

Receive Message from remote UDP/IP connection (via Ethernet) (Refer to Section 19.2)

### Return :

**Msg\_** Message The received Message. If Msg\_ = " (Empty message), it indicates there is no Message coming

### Note :

1. The receiving buffer size of UDP for W-8xx7 is 8192 bytes including the 1 byte ending symbol of each String. The receiving buffer size for I-7188EG & I-8x37 is 2048 bytes.
2. If there coming too many Strings at the same time and the receiving buffer cannot handle in time, the new coming String will replace the earliest coming String.

### Example :

Wpdmo19 & Wpdmo19a (WP-8xx7 CD\_ROM:\napdos\isagraf\wp-8xx7\demo\  
[www.icpdas.com](http://www.icpdas.com) > FAQ > Software > ISaGRAF > 065

## UDP\_SEND

- I-8x17/iP-8x17 ■ I-8x37/iP-8x47 ■ I-7188EG/7186EG □ I-7188XG
- ISaGRAF WinCE PAC

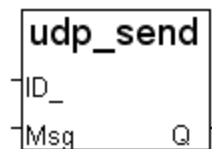

### Description : C\_Function

Send Message to remote UDP/IP connection (via Ethernet) (Refer to Section 19.2)

### Input Parameters :

**ID\_** Integer The related connection to send, 1~4. The related "ip address" and "port No." is defined in "udp\_ip" of I/O connection window.

**Msg\_** Message The Message to send.

### Return :

**Q\_** Boolean True: OK;  
False: the sending buffer is full or parameter error(Ex: ID\_ = 8).

### Note :

1. The sending buffer size of UDP for W-8xx7 is 2048 bytes including the 1 byte ending symbol. It means W-8xx7 can send out max to 2048 bytes in each ISaGRAF PLC Scan.
2. Do not send a lot of messages frequently because of the "Send\_Time\_Gap" parameter in the I/O connection "udp\_ip". When there are too many messages, the sending buffer will full, and the udp\_send( ) will return FALSE that means the buffer is full and cannot put in more Message . The controller driver sends only one message out each PLC scan relating to each UDP connection.

### Example :

Wpdmo19 & Wpdmo19a (WP-8xx7 CD\_ROM:\napdos\isagraf\wp-8xx7\demo\  
[www.icpdas.com](http://www.icpdas.com) > FAQ > Software > ISaGRAF > 065

## V\_BCD

■ I-8x17/iP-8x17 ■ I-8x37/iP-8x47 ■ I-7188EG/7186EG ■ I-7188XG ■ ISaGRAF WinCE PAC

### Description : C\_Function

Convert value to BCD value.

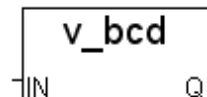

### Input Parameters :

**IN\_** Integer Decimal value to be converted, valid range: 0 ~ 99999999

### Return :

**Q\_** Integer BCD value ex: 12345 → 16#12345  
16 → 22 (16#16)

## V0\_10\_TO

■ I-8x17/iP-8x17 ■ I-8x37/iP-8x47 ■ I-7188EG/7186EG ■ I-7188XG

■ ISaGRAF WinCE PAC

### Description : C\_Function

Convert Analog Input from 0-10 V to User's Engineering Value ("Real" format), Ex: Convert the Analog input of I-8017H to 0-100 psi or 0-3000 rpm.

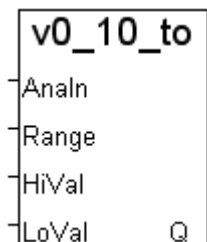

### Input Parameters :

**Analn\_** Integer The Integer variable related to the Analog input board or module. Valid range: -32768 ~ +32767, depends on the range setting of the IO module.

**Range\_** Integer The range setting of Analog Input IO card or module.

16#0 : -15mV ~ +15 mV  
16#1 : -50mV ~ +50 mV  
16#2 : -100mV ~ +100 mV  
16#3 : -500mV ~ +500 mV  
16#4 : -1 ~ +1 V  
16#5 : -2.5 ~ +2.5 V  
16#7 : -1.25 ~ +1.25 V  
16#8 : -10 ~ +10 V  
16#9 : -5 ~ +5 V  
16#A : -1 ~ +1 V  
16#B : -500mV ~ +500 mV  
16#C : -150mV ~ +150 mV

**HiVal\_** Real User's related High Eng. value when Analog input signal is 10 V

**LoVal\_** Real User's related Low Eng. value when Analog input signal is 0 V

Ex: Convert I-8017H's Input signal from 0 - 10 V to 0 - 100 psi, please set HiVal\_ = 100.0 , LoVal\_ = 0.0 & Range\_ = 16#5 or 16#7 or 16#8 or 16#9 (depends on the range setting of the related IO board).

### Return :

**Q\_** Real The User Engineering value after conversion.  
If given incorrect Range\_ , returns 1.23E-20.

**Note:** 1. The related range setting of Analog Input card or module must be Voltage.

Ex: (-10 , +10V) , (-5 , +5V) , (-1 , 1 V) , etc Voltage range.

2. When using A4\_20\_to, To\_A4\_20, To\_V0\_10, V0\_10\_to functions, user needs to upgrade the driver to the version listed below or latter version: i-7188EG: v2.16, i-7188XG: v2.14, i-8xx7:v3.18, so that the program can run well. (The older driver may cause the program cease after running a period of time.).

## VAL\_HEX

■ I-8x17/iP-8x17 ■ I-8x37/iP-8x47 ■ I-7188EG/7186EG ■ I-7188XG ■ ISaGRAF WinCE PAC

### Description : C\_Function

Convert an Integer to a fixed-length hex-message.



### Input Parameters :

<b>VAL_</b>	Integer	The Integer to be converted
<b>DIGIT_</b>	Integer	Number of digits for HEX_ message. Valid value: 1 ~ 8. Given others will do nothing and force HEX_ to " (Empty Message).

### Return :

<b>HEX_</b>	Message	The hex-message after conversion.
-------------	---------	-----------------------------------

### Example:

val_hex(100,3)	--->	'064'
val_hex(192,4)	--->	'00C0'
val_hex(4589,2)	--->	'ED' ( '11ED', DIGIT_ is 2, force '11' truncated)
val_hex(4589,9)	--->	' ' (DIGIT_ > 8, output ' ')
val_hex(-2,8)	--->	'FFFFFFFFE'

## VAL10LED

■ I-8x17/iP-8x17 ■ I-8x37/iP-8x47 ■ I-7188EG/7186EG ■ I-7188XG □ ISaGRAF WinCE PAC

### Description : C\_Function

Display a decimal Integer on S-MMI

### Input Parameters :

<b>RUN_</b>	Boolean	If TRUE, display it
<b>FLASH_</b>	Boolean	If TRUE, blink it
<b>CLK_</b>	Timer	The blinking period
<b>VAL_I_</b>	Integer	The Integer to display, -9999 ~ +99999

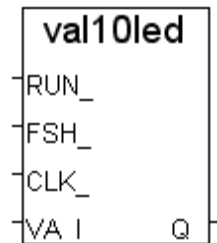

### Return :

<b>Q_</b>	Boolean	Return TRUE always
-----------	---------	--------------------

**Example:** Please refer to demo\_07 & demo\_11b.

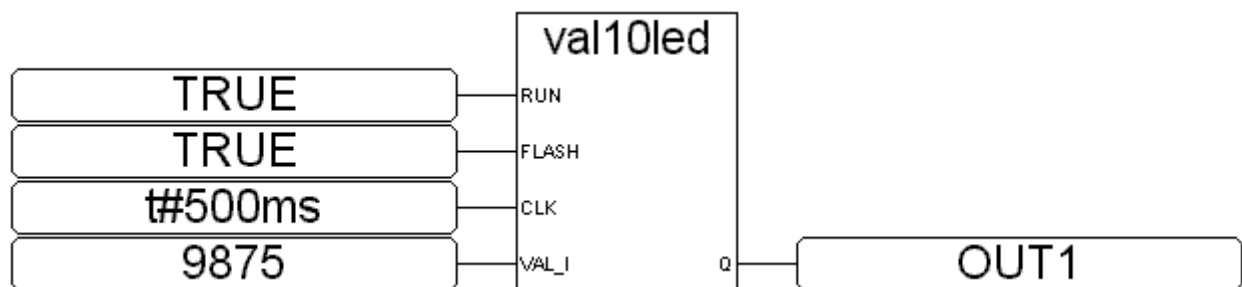

### ST Equivalence:

```
TMP := VAL10LED(TRUE,TRUE,t#500ms,9875);  
(* TMP is declared as Boolean variable *)
```

## VAL16LED

■ I-8x17/iP-8x17 ■ I-8x37/iP-8x47 ■ I-7188EG/7186EG ■ I-7188XG □ ISaGRAF WinCE PAC

### Description : C\_Function

Display a hexadecimal Integer on S-MMI

### Input Parameters :

<b>RUN_</b>	Boolean	If TRUE, display it
<b>FLASH_</b>	Boolean	If TRUE, blink it
<b>CLK_</b>	Timer	The blinking period
<b>VAL_I_</b>	Integer	The value to display, 16#0 ~ 16#FFFFFF

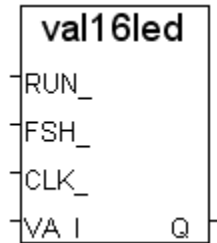

### Return :

<b>Q_</b>	Boolean	Return TRUE always
-----------	---------	--------------------

### Example:

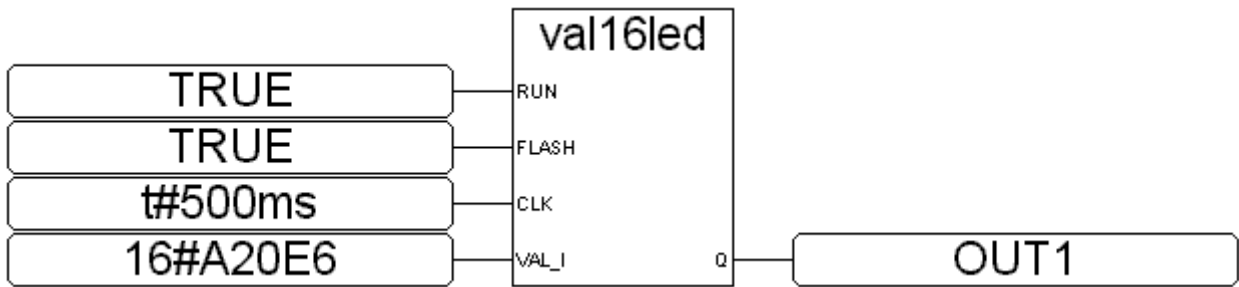

### ST Equivalence:

```
TMP := VAL10LED(TRUE,FALSE,t#500ms,16#A20E6);  
(*TMP is declared as Boolean variable*)
```



## W\_MB\_ADR

■ I-8x17/iP-8x17 ■ I-8x37/iP-8x47 ■ I-7188EG/7186EG ■ I-7188XG ■ ISaGRAF WinCE PAC

### Description : C\_Function

Write Boolean or Integer variable by using Modbus network address

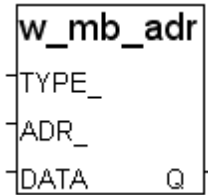

### Input Parameters :

**TYPE\_** Integer 0: Boolean variable, 1: Integer variable  
**ADR\_** Integer The Modbus address to write to,  
Valid range for Wincon: 1~8191; others: 1~4095.  
**DATA\_** Integer The Integer to write (For Boolean, 0:False, 1:True.)

### Return :

**Q\_** Boolean TRUE : ok; FALSE: fail.

### Note :

1. Please use W\_MB\_REL function to write "REAL" variable.
2. If no variable defined with the given Modbus address, no write action.
3. If TYPE\_ is given as Integer however the related variable is "Real" typed, the related 32-bit is written. It is better to use "W\_MB\_REL" to write Real variable.
4. If TYPE\_ is given as Integer however the related variable is "Boolean" typed, no write action.
5. If TYPE\_ is given as Boolean however the related variable is not "Boolean" typed, no write action.
6. If Long Integer value (32-bit integer) is to be delivered to HMI via Modbus protocol, it should occupy 2 Modbus address number. Please refer to Section 4.2 of "User's Manual Of The ISaGRAF PAC".

## W\_MB\_REL

■ I-8x17/iP-8x17 ■ I-8x37/iP-8x47 ■ I-7188EG/7186EG ■ I-7188XG ■ ISaGRAF WinCE PAC

### Description : C\_Function

Write REAL variable by using its network address number

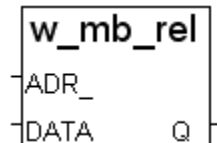

### Input Parameters :

**ADR\_** Integer The Modbus address to write to,  
Valid range for Wincon: 1~8191, others: 1~4095  
**DATA\_** Real The REAL to write

### Return :

**Q\_** Boolean TRUE : ok, FALSE : fail

### Note :

1. Please check the related variable is "Real" type. If it is "Integer", please use "W\_MB\_ADR" function.
2. If the given TYPE\_ is not "Analog" (Real or Integer), no write action.
3. If no variable defined with the given Modbus address, no write action.
4. If REAL value is to be delivered to HMI via Modbus protocol, it should occupy 2 Modbus address number. Please refer to Section 4.2 of "User's Manual Of The ISaGRAF PAC".

## WD\_BIT

■ I-8x17/iP-8x17 ■ I-8x37/iP-8x47 ■ I-7188EG/7186EG ■ I-7188XG ■ ISaGRAF WinCE PAC

### Description : C\_Function Block

Convert a Word value (signed 16-bit) to 16 Boolean values

#### Input Parameters :

**VAL\_** Integer The Word to be converted.  
(only the lowest 16-bit are used)

#### Return :

**ENO\_** Boolean Reserved; no usage.  
**B1\_ ~ B16\_** Boolean The 16 Boolean values after conversion  
Ex: If VAL\_ is 4, B3\_ will be TRUE  
and others will be FALSE.

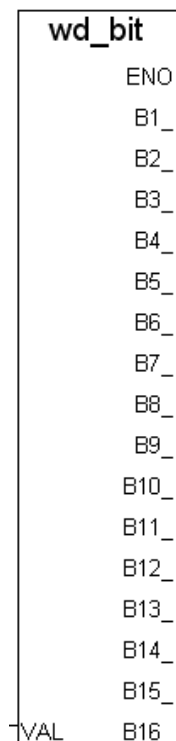

## WD\_LONG

■ I-8x17/iP-8x17 ■ I-8x37/iP-8x47 ■ I-7188EG/7186EG ■ I-7188XG ■ ISaGRAF WinCE PAC

### Description : C\_Function

Convert two Words (signed 16-bit) to one Long Integer (signed 32-bit)

#### Input Parameters :

**Lo\_** Integer Low Word to be converted (only the lowest 16-bit is used)  
**Hi\_** Integer High Word to be converted (only the lowest 16-bit is used)

#### Return :

**Long\_** Integer The 32-bit Integer composed by Lo\_ and Hi\_ word

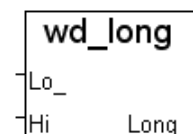

#### Example:

Lo_	Hi_	---	Long_
-32768 (8000)	-1 (FFFF)	---	-32768 (FFFF 8000)
-1 (FFFF)	-1 (FFFF)	---	-1 (FFFF FFFF)
-32768 (8000)	0 (0000)	---	+32768 (0000 8000)
100 (0064)	4103 (1007)	---	+ 268 894 308 (1007 0064)

# Appendix B : Setting The IP, Mask & Gateway In The I-8x37/iP-8x47, I-7188EG & μPAC-7186EG

This document describe the proper way to set the IP address, address mask and gateway address of the I-8x37/iP-8x47, I-7188EG & μPAC-7186EG controllers.

For the setting of WinCon-8xx7/8xx6, please refer to "Getting Started Manual" delivered with Wincon or at [http://www.icpdas.com/products/PAC/i-8000/getting\\_started\\_manual.htm](http://www.icpdas.com/products/PAC/i-8000/getting_started_manual.htm) .

\*\*\*\*\*  
EACH I-8x37/iP-8x47, I-7188EG & μPAC-7186EG USES TCP/IP PORT NO. 502 TO TALK TO THE HMI AND ISAGRAF WORKBENCH. A MAXIMUM NUMBER OF 4 PCS CAN TALK TO THE I-8x37/iP-8x47, I-7188EG & μPAC-7186EG THROUGH MODBUS TCP/IP PROTOCOL.  
\*\*\*\*\*

### The setting steps for I-7188EG & μPAC-7186EG controller:

1. Create a file folder named "7188" in your hard drive. For example: "c:\7188".
2. Copy \Napdos\ISaGRAF\7188EG\Driver\7188xw.exe, 7188xw.ini, from the CD\_ROM into your "7188" folder.
3. Run "\7188\7188xw.exe" (For Windows NT, Windows 2000 & Windows XP)
4. Link from COM1/COM2 of your PC to COM1 of the I-7188EG/μPAC-7186EG by a RS232 cable (CA0910).

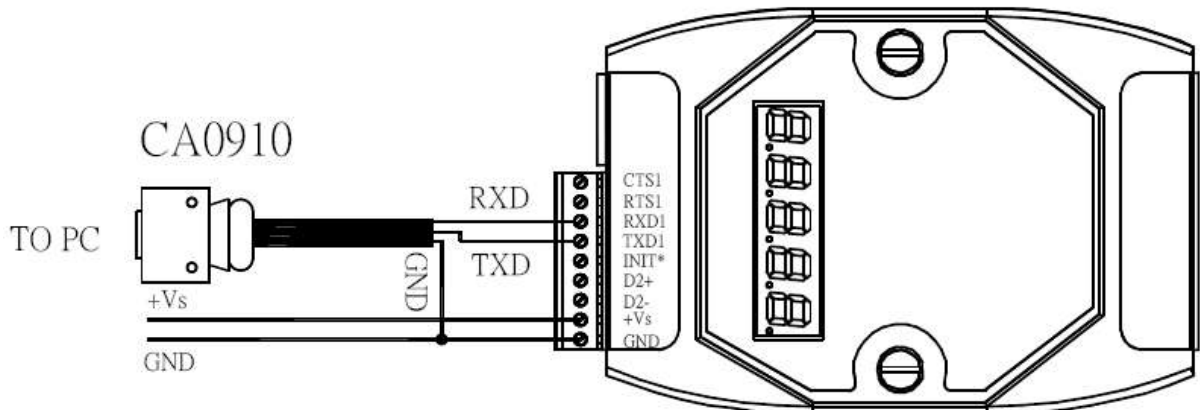

If your computer has no COM1/COM2 or you use other COM (like COM5) to link the I-7188, you can change the "C number" in the first line of "7188xw.ini" file.

EX: Using computer's COM5 to link to I-7188

```

C1 B115200 P0 D8 S1
F
Xautoexec.bat Xisa7188e.exe
w25
    
```



```

C5 B115200 P0 D8 S1
F
Xautoexec.bat Xisa7188e.exe
w25
    
```

5. Power off the I-7188EG/ $\mu$ PAC-7186EG, connect pin "INIT\*" to "GND", then power it up.
6. If the connection is Ok, "i7188E>" messages will appear on the 7188xw screen.
7. Type "ip" to see the current IP address of the I-7188EG
8. Type "ip xxx.xxx.xxx.xxx" to set to a new IP address.  
Ex: i7188E> ip 192.168.1.200
9. Type "mask" to see the current address mask of the I-7188EG.
10. Type "mask xxx.xxx.xxx.xxx" to set to a new address mask.  
Ex: i7188E> mask 255.255.255.0
11. Type "gateway" to see the current gateway address.  
i7188E> gateway
12. Type "gateway xxx.xxx.xxx.xxx" to set to a new gateway address.  
i7188E> gateway 192.168.1.1
13. Press ALT\_X to exit "7188xw", or COM1/COM2 of the PC will be occupied.
14. Remove the connection between "INIT" - "GND", recycle the power of the I-7188EG/ $\mu$ PAC-7186EG controller.

```
i7188E>ip
IP=192.168.255.1
i7188E>ip 192.168.1.200
Set IP=192.168.1.200
[ReadBack]IP=192.168.1.200
i7188E>mask
MASK=255.255.0.0
i7188E>mask 255.255.255.0
Set MASK=255.255.255.0
[ReadBack]MASK=255.255.255.0
i7188E>gateway
Gateway=192.168.0.1
i7188E>gateway 192.168.1.1
Set GATEWAY=192.168.1.1
[ReadBack]Gateway=192.168.1.1
i7188E>_
```

**The setting steps for I-8x37/iP-8x47 controller:**

1. Create a file folder named "8000" in your hard drive. For example, "c:\8000".
2. Copy CD-ROM: \Napdos\ISaGRAF\8000\Driver\...\7188xw.exe, 7188xw.ini from the CD\_ROM into your "8000" folder.
3. Run "\8000\7188xw.exe" in your hard drive. A "7188xw" screen will appear.
4. Link from COM1 or COM2 of PC to COM1 of the I-8437 / 8837 controller by a RS232 cable.

If you use other COM port (ex.COM5), please modify the first line of "7188xw.ini".

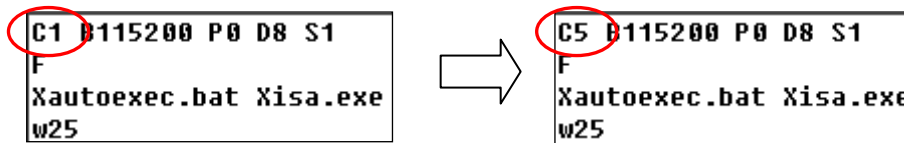

5. Power off the I-8x37/iP-8x47 controller, connect pin "INIT" to "INIT COM", then power it up.
6. If the connection is Ok, messages will appear on the 7188xw screen.

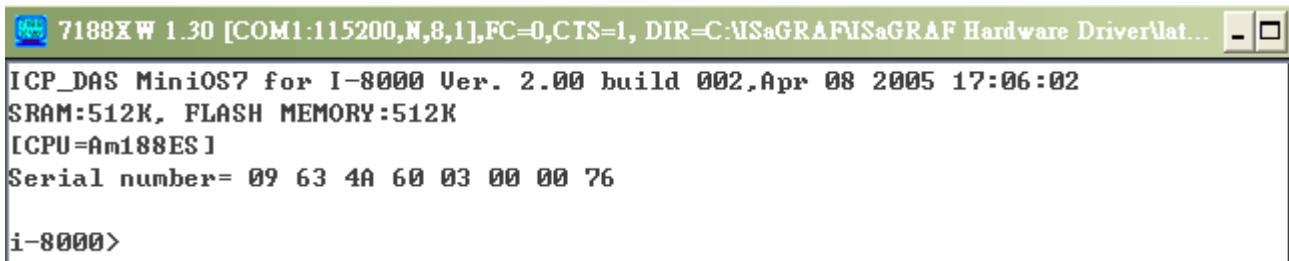

7. Use dos command (ipconfig) to search out the setup of network.

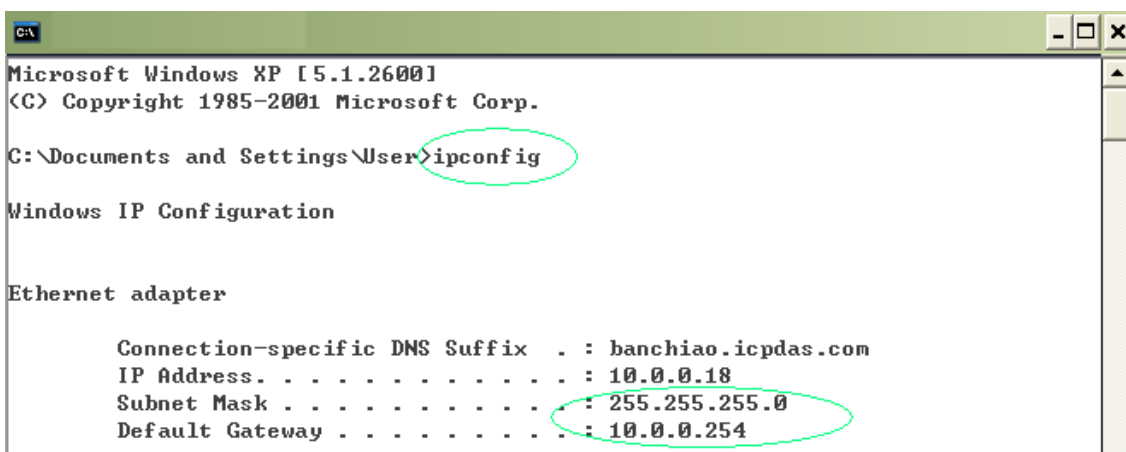

★ Please according as your computer to following setup (IP/MASK/GATEWAY)

8. Type "ip" to see the current IP address of the I-8x37/iP-8x47.  
Type "**ip 10.0.0.xxx**" to setup a new IP address

```
7188X W 1.30 [COM1:115200,N,8,1],FC=0,CTS=1, DIR=C:\ISaGRAF\ISaGRAF Hardware Driver\lat...
7188x for WIN32 version 1.30 (2005/11/29)[By ICPDAS. Tim Tsai.]
[Begin Key Thread...][Current set: Use COM1 115200,N,8,1
AutoRun:
Autodownload files: autoexec.bat isa.exe
Current work directory="C:\ISaGRAF\ISaGRAF Hardware Driver\latest_8k\latest_8k\3
.16"
original baudrate = 115200!
now baudrate = 115200!

i-8000>ip
IP=10.0.0.123
i-8000>ip 10.0.0.123
Set IP=10.0.0.123
[ReadBack]IP=10.0.0.123
i-8000>
```

9. Type "mask" to see the current address mask of the I-8x37/iP-8x47.  
Type "**mask 255.255.255.0**" to setup a new address mask.

```
i-8000>mask
MASK=255.255.255.0
i-8000>mask 255.255.255.0
Set MASK=255.255.255.0
[ReadBack]MASK=255.255.255.0
i-8000>
```

10. Type "gateway" to see the current gateway address.  
Type "**gateway 10.0.0.254**" to setup a new gateway address.

```
i-8000>gateway
Gateway=10.0.0.254
i-8000>gateway 10.0.0.254
Set GATEWAY=10.0.0.254
[ReadBack]Gateway=10.0.0.254
i-8000>
```

11. Press **ALT\_X** to exit "7188xw", or COM1/COM2 of the PC will be occupied.
12. Remove the connection between "INIT" - "INIT COM", recycle the power of I-8x37/iP-8x47 controller.

# Appendix C : Update The I-8417/8817/8437/8837 Controller to New Hardware Driver

The ISaGRAF embedded driver is firmware burned into the flash memory of the I-8417 / 8817 / 8437 / 8837 controller. It can be easily upgraded by the user.

For updating driver of the I-7188EG/XG,  $\mu$ PAC-7186EG and ISaGRAF WinCE PAC, please refer to the "Getting Started" Manual in their respective folder of CD\_ROM : Napdos\ISaGRAF\ or at [http://www.icpdas.com/products/PAC/i-8000/getting\\_started\\_manual.htm](http://www.icpdas.com/products/PAC/i-8000/getting_started_manual.htm) .

Our newly released driver can be obtained from the following websites:

**Note:** The file name will be different (\*.img file) for different version.

<http://www.icpdas.com/products/PAC/i-8000/isagraf.htm> or

<http://www.icpdas.com/products/PAC/i-8000/isagraf-link.htm> (please extract the zip file).

## Warning:

The copyright of the firmware and the ISaGRAF embedded driver belongs to ICP DAS CO., LTD. Only the I-8417/8817/8437/8837, I-7188EG/XG,  $\mu$ PAC-7186EG & ISaGRAF WinCE PAC have registered a legal ISaGRAF Target license. To burn an ISaGRAF embedded driver into other controllers is absolutely illegal and may be punished by law.

**Note:** Make sure of your current OS & driver version before you upgrade it.

## To Know The Current Driver Version: (We use driver 3.16 as an example)

1. Create a file folder named "8000" in your hard drive .For example, "**c:\8000**".
2. Copy Napdos\ISaGRAF\8000\Driver\40m\3.16\Napdos\ISaGRAF\8000\Driver\40m\3.16\
  - ① **7188xw.exe**, ② **7188xw.f4**, ③ **7188xw.ini**, ④ **8k050408.img**, ⑤ **autoexec.bat**,
  - ⑥ **isa.exe**, ⑦ **isa\_data.exe** from the CD\_ROM into your "**8000**" folder.
3. Run "\8000\7188xw.exe" in your hard drive. A "7188xw" screen will appear. (F1: help).
4. Link COM1 or COM2 of your PC to COM1 of the controller through a RS232 cable.  
If you use other COM port (ex.COM5), please modify the first line of "7188xw.ini".

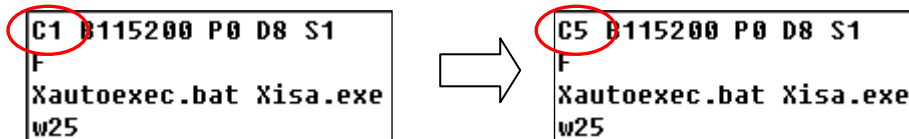

5. Power off I-8X417/8X37, connect pin "INIT" to "INIT COM" and then power it up.
6. If the connection is Ok, "i-8000>" messages will appear on the 7188xw screen.

```
7188XW 1.30 [COM1:115200,N,8,1],FC=0,CTS=1, DIR=C:\MSaGRAF\ISaGRAF Hardware Driver\lat...
ICP_DAS MiniOS7 for I-8000 Ver. 2.00 build 002.Apr 08 2005 17:06:02
SRAM:512K, FLASH MEMORY:512K
[CPU=Am188ES]
Serial number= 09 63 4A 60 03 00 00 76
i-8000>
```

7. Type "ver" to see the current OS version & date.
8. Type "isa \*p=" to see the current driver version No. & setting of the controller.

```

i-8000>ver
ICP_DAS MiniOS7 for I-8000 Ver. 2.00 build 002, Apr 08 2005 17:06:02
SRAM:512K, FLASH MEMORY:512K
[CPU=Am188ES]
Serial number= 09 63 4A 60 03 00 00 76

i-8000>isa *p=
Driver : I-8xx7 : isa.exe - 3.16, Oct.25,2006
MiniOS7 : Must use 8k050408.img
isa_data.exe - 1.8, Oct.25,2006
NED-ID : 1
COM1 is Modbus RTU slave port,19200,8,N,1
COM3 is Modbus RTU slave port,19200,8,N,1
Use 'isa *f=1' to free COM1, 'isa *f=0' to set COM1 as Modbus RTU

<C>Copyright:ICP DAS CO., LTD. Taiwan Id:84517297_

```

### To Upgrade An ISaGRAF Embedded Driver:

9. Power off the controller, connect pin "INIT" to "INIT COM" and then power it up.
10. Press "**F4**" to auto download the following files and reboot system.  
(isa\_data.exe, autoexec.bat, isa.exe, 8k050408.img)

```

i-8000>del /y
Total File number is 2, do you really want to delete(y/n)?

i-8000>LOAD
File will save to 8000:0000
StartAddr-->7000:FFFF
Press ALT_E to download file!
Load file:isa_data.exe [crc=E70F,0000]
Send file info. total 287 blocks
Block 287
Transfer time is: 12.844000 seconds

```



 Wait about 60 sec. to update ISaGRAF system & DO NOT REMOVE THE POWER

```
i-8000>bios1
MiniOs7 for 8000 Ver 2.00.002, date=04/08/2005
Checking CRC-16...OK.
Update the OS code. Please wait the message <<Write Finished>>
Erase Flash [F000]
Write Flash
[FF]
<<Write Finished>>OK
Wait WDT reset system...
ICP_DAS MiniOS7 for I-8000 Ver. 2.00 build 002, Apr 08 2005 17:06:02
SRAM:512K, FLASH MEMORY:512K
[CPU=RDC 8820-D]
Serial number= 5A 5A 5A 5A 5A 5A 5A 5A
```

11. Type "dir" to make sure "autoexec.bat" and "isa.exe" are well burned

```
i-8000>DIR
0)autoexec.bat 05/21/2003 06:40:00 22[00016]8002:0000-8003:0006
1)isa.exe 10/25/2006 10:28:00 180678[2C1C6]8005:0006-AC21:000C
Total File number is 2 Free space=277956 bytes
```

12. Press ALT+X to exit "7188xw".

13. Remove the connection between "INIT" - "INIT COM", recycle the power of the controller.

# Appendix C.1: Setting I-8xx7 & I-7188EG's COM1 As None-Modbus-Slave port

COM1 of the I-8417/8817/8437/8837, I-7188EG or  $\mu$ PAC-7186EG supports Modbus RTU Slave protocol by default. User may change it to a None-Modbus-Slave port for other usage. For example, user may write his own defined protocol on COM1 or use COM1 as a Modbus Master port.

**Note :** For **7188XG**, COM1 is for Modbus RTU Slave protocol **ONLY, can't be free.**

**Steps:** \*\* We use I-7188EG as an example. (The description in the parentheses is for I-8000.)

1. Create a file folder named "7188" in your hard drive. Ex: "c:\7188". (**I-8000:** Ex. "c:\8000")
2. Copy \Napdos\ISaGRAF\7188EG\Driver\7188xw.exe, 7188xw.ini, from the CD\_ROM into your "7188" folder. (**I-8000:** please copy to "8000" folder)
3. Run "\7188\7188xw.exe". (For Windows NT, Windows 2000 & Windows XP)
4. Link from COM1 of your PC to COM1 of the I-7188EG/ $\mu$ PAC-7186EG by a RS232 cable.

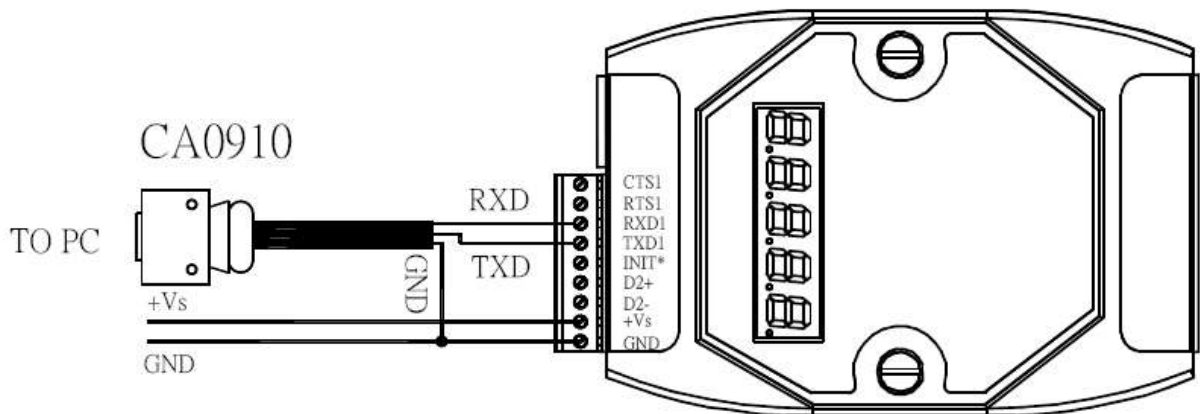

If your computer has no COM1/COM2 or you use other COM (like COM5) to link the I-7188, you can change the "C number" in the first line of "7188xw.ini" file.

EX: Using computer's COM5 to link to I-7188

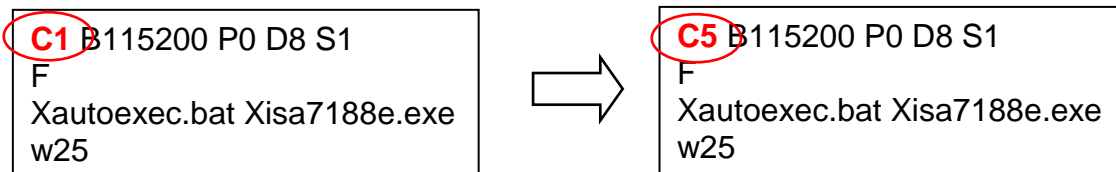

5. Power off 7188EG/7186EG, connect pin "INIT\*" to "GND", then power up. (**I-8000:** connect "INIT" & "INIT COM")
6. If the connection is Ok, "i7188E>" messages will appear on the screen. (**I-8000:** "i-8000>" )

7. Type "isa7188e \*f=1" to free COM1 (set COM1 as none-Modbus-Slave port)

```
i7188E> isa7188e *f=1    (for I-7188EG)
i7188E> isa7186e *f=1    (for μPAC-7186EG)
i-8000> isa *f=1        (for I-8000)
```

8. Press ALT\_X to exit "7188xw", or COM1/COM2 of the PC will be occupied.

9. Remove the connection between "INIT" - "GND", recycle the power of the controller.  
(**I-8000**: remove the connection of "INIT"–"INIT COM" )

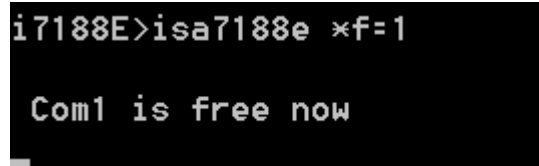

```
i7188E>isa7188e *f=1
Com1 is free now
```

### Important Note:

If user wants COM1 to be back to a Modbus RTU Slave port again, follow the same steps as above & then type "isa7188e \*f=0" as below

```
Ex1:  I-7188E> isa7188e *f=0    (for I-7188EG)
Ex2:  I-7188E> isa7186e *f=0    (for μPAC-7186EG)
Ex3:  I-8000> isa *f=0          (for I-8000)
```

## Appendix D : Table of The Analog IO Value

### I-87013, I-7013, I-7033, I-7015, M-7015, M-7033, I-87015

Range Type Code (Hex)	RTD Type	Data Format	Max Value	Min Value
20 (Default)	Platinum 100 a = 0.00385 -100 ~ 100 °C	Temperature (Celsius)	+100.0	-100.0
		Decimal Value	+32767	-32768
		2's complement HEX	7FFF	8000
		Ohms	+138.50	+060.60
21	Platinum 100 a = 0.00385 0 ~ 100 °C	Temperature (Celsius)	+100.0	+0.0
		Decimal Value	+32767	+0
		2's complement HEX	7FFF	0000
		Ohms	+138.50	+100.00
22	Platinum 100 a = 0.00385 0 ~ 200 °C	Temperature (Celsius)	+200.0	+0.0
		Decimal Value	+32767	+0
		2's complement HEX	7FFF	0000
		Ohms	+175.84	+100.00
23	Platinum 100 a = 0.00385 0 ~ 600 °C	Temperature (Celsius)	+600.0	+0.0
		Decimal Value	+32767	+0
		2's complement HEX	7FFF	0000
		Ohms	+313.59	+100.00
24	Platinum 100 a = 0.003916 -100 ~ 100 °C	Temperature (Celsius)	+100.0	-100.0
		Decimal Value	+32767	-32768
		2's complement HEX	7FFF	8000
		Ohms	+139.16	+060.60
25	Platinum 100 a = 0.003916 0 ~ 100 °C	Temperature (Celsius)	+100.0	+0.0
		Decimal Value	+32767	+0
		2's complement HEX	7FFF	0000
		Ohms	+139.16	+100.00
26	Platinum 100 a = 0.003916 0 ~ 200 °C	Temperature (Celsius)	+200.0	+0.0
		Decimal Value	+32767	+0
		2's complement HEX	7FFF	0000
		Ohms	+177.14	+100.00
27	Platinum 100 a = 0.003916 0 ~ 600 °C	Temperature (Celsius)	+600.0	+0.0
		Decimal Value	+32767	+0
		2's complement HEX	7FFF	0000
		Ohms	+317.28	+100.00

Range Type Code (Hex)	RTD Type	Data Format	Max Value	Min Value
28	Nickel 120 -80 ~ 100 °C	Temperature (Celsius)	+100.0	-80.0
		Decimal Value	+32767	-26214
		2's complement HEX	7FFF	999A
		Ohms	+200.64	+066.60
29	Nickel 120 0 ~ 100 °C	Temperature (Celsius)	+100.0	+0.0
		Decimal Value	+32767	+0
		2's complement HEX	7FFF	0000
		Ohms	+200.64	+120.60
2A	Platinum 1000 a = 0.00385 -200 ~ 600 °C	Temperature (Celsius)	+600.0	-200.0
		Decimal Value	+32767	-10922
		2's complement HEX	7FFF	D556
		Ohms	+3137.1	+0185.2
2B*	Cu 100 a = 0.00421 -20 ~ +150 °C	Temperature (Celsius)	+150.0	-20.0
		Decimal Value	+32767	-4369
		2's complement HEX	7FFF	EEEE
		Ohms	+163.17	+091.56
2C*	Cu 100 a = 0.00427 0 ~ 200 °C	Temperature (Celsius)	+200.0	0.0
		Decimal Value	+32767	0
		2's complement HEX	7FFF	0
		Ohms	+167.75	+090.34
2D*	Cu 1000 a = 0.00421 -20 ~ 150 °C	Temperature (Celsius)	+150.0	-20.0
		Decimal Value	+32767	-4369
		2's complement HEX	7FFF	EEEE
		Ohms	+1631.7	+0915.6
2E	Platinum 100 a = 0.00385 -200 ~ 200 °C	Temperature (Celsius)	+200.0	-200.0
		Decimal Value	+32767	-32768
		2's complement HEX	7FFF	8000
		Ohms	+175.84	+018.49
2F	Platinum 100 a = 0.003916 -200 ~ 200 °C	Temperature (Celsius)	+200.0	-200.0
		Decimal Value	+32767	-32768
		2's complement HEX	7FFF	8000
		Ohms	+177.14	+017.14
80	Platinum 100 a = 0.00385 -200 ~ 600 °C	Temperature (Celsius)	+600.0	-200.0
		Decimal Value	+32767	-10922
		2's complement HEX	7FFF	D556
		Ohms	+313.59	+018.49

Range Type Code (Hex)	RTD Type	Data Format	Max Value	Min Value
81	Platinum 100 a = 0.003916 -200 ~ 600 °C	Temperature (Celsius)	+600.0	-200.0
		Decimal Value	+32767	-10922
		2's complement HEX	7FFF	D556
		Ohms	+317.28	+017.14

\* Range Type Code 2B, 2C and 2D are only supported by I-7015, M-7015 & I-87015.

\* I-87015, I-7015 & M-7015: Each channel can be configured to different range ID.

## I-8017H(8-ch), I-8017HS(16-ch)

---

Range Type Code (Hex)	Data Format	Max value	Min value
05	Input Range	+2.5 V	-2.5 V
	Decimal Value	+32767	-32768
	2's Complement HEX	7FFF	8000
06*	Input Range	+20.0 mA	-20.0 mA
	Decimal Value	+32767	-32768
	2's Complement HEX	7FFF	8000
07	Input Range	+1.25 V	-1.25 V
	Decimal Value	+32767	-32768
	2's Complement HEX	7FFF	8000
08 (Default)	Input Range	+10.0 V	-10.0 V
	Decimal Value	+32767	-32768
	2's Complement HEX	7FFF	8000
09	Input Range	+5.0 V	-5.0 V
	Decimal Value	+32767	-32768
	2's Complement HEX	7FFF	8000

\* I-8017H: Each channel can be configured to different range ID.

\* Using Code 06, module needs to connect with an additional 125Ω resistor in each current input channel.

## I-87017, I-87017R, I-7017, I-7017R, M-7017, M-7017R

Range Type Code (Hex)	Data Format	Max value	Min value
08 (Default)	Input Range	+10.0 V	-10.0 V
	Decimal Value	+32767	-32768
	2's Complement HEX	7FFF	8000
09	Input Range	+5.0 V	-5.0 V
	Decimal Value	+32767	-32768
	2's Complement HEX	7FFF	8000
0A	Input Range	+1.0 V	-1.0 V
	Decimal Value	+32767	-32768
	2's Complement HEX	7FFF	8000
0B	Input Range	+500.0 mV	-500.0 mV
	Decimal Value	+32767	-32768
	2's Complement HEX	7FFF	8000
0C	Input Range	+150.0 mV	-150.0 mV
	Decimal Value	+32767	-32768
	2's Complement HEX	7FFF	8000
0D*	Input Range (with 125 ohms resistor)	+20.0 mA	-20.0 mA
	Decimal Value	+32767	-32768
	2's Complement HEX	7FFF	8000

\* Using Code 0D, module needs to connect with an additional 125Ω resistor in each current input channel.



## I-7017RC, M-7017RC, I-87017RC

---

Range Type Code (Hex)	Data Format	Max value	Min value
7	Input Range	+20.0 mA	+4.0 mA
	Decimal Value	+32767	0
	2's Complement HEX	7FFF	0
D	Input Range	+20.0 mA	-20.0 mA
	Decimal Value	+32767	-32768
	2's Complement HEX	7FFF	8000
1A	Input Range	+20.0 mA	0 mA
	Decimal Value	+32767	0
	2's Complement HEX	7FFF	0

\* I-7017RC, M-7017RC & I-87017RC modules do not need an additional resistor when using them to measure current.

# I-87018Z, I-87018R, I-87018, I-87019R, I-7018Z, I-7018R, I-7018, M-7018, M-7018R, I-7019R, M-7019R (1)

Range Type Code (Hex)	Data Format	Max value	Min value
00	Input Range	-15.0 mV	-15.0 mV
	Decimal Value	+32767	-32768
	2's Complement HEX	7FFF	8000
01	Input Range	+50.0 mV	-50.0 mV
	Decimal Value	+32767	-32768
	2's Complement HEX	7FFF	8000
02	Input Range	+100.0 mV	-100.0 mV
	Decimal Value	+32767	-32768
	2's Complement HEX	7FFF	8000
03	Input Range	+500.0 mV	-500.0 mV
	Decimal Value	+32767	-32768
	2's Complement HEX	7FFF	8000
04	Input Range	+1.0 V	-1.0 V
	Decimal Value	+32767	-32768
	2's Complement HEX	7FFF	8000
05 (Default)	Input Range	+2.5V	-2.5V
	Decimal Value	+100.00	-100.00
	2's Complement HEX	7FFF	8000
06*	Input Range	+20.0 mA	-20.0 mA
	Decimal Value	+32767	-32768
	2's Complement HEX	7FFF	8000

\* I-7019, I-7019R, M-7019, M-7019R & I-87019R measure current (Code 6) by jumper setting, but the other Modules need to add an additional 125Ω resistor for measuring current.

\* I-87018Z & I-7018Z: 10 Channels, each channel can be configured to different Type Code.

➤ **I-87018Z & I-7018Z** also support the types listed below:

Range Type Code (Hex)	Data Format	Max value	Min value
7	Input Range	+20.0 mA	+4.0 mA
	Decimal Value	+32767	0
	2's Complement HEX	7FFF	0
1A	Input Range	+20.0 mA	0 mA
	Decimal Value	+32767	0
	2's Complement HEX	7FFF	0

# I-87018Z, I-87018R, I-87018, I-87019R, I-7018Z, I-7018R, I-7018, M-7018, M-7018R, I-7019R, M-7019R (2)

Range Type Code (Hex)	Thermocouple Type	Data Format	Max Value	Min Value
0E	J Type -210 ~ 760 °C	Temperature (Celsius)	+760.0	-210.0
		Decimal Value	+32767	-9054
		2's Complement HEX	7FFF	DCA2
0F	K Type -270 ~ 1372 °C	Temperature (Celsius)	+1372.0	-270.0
		Decimal Value	+32767	-6448
		2's Complement HEX	7FFF	E6D0
10	T Type -270 ~ 400 °C	Temperature (Celsius)	+400.0	-270.0
		Decimal Value	+32767	-22118
		2's Complement HEX	7FFF	A99A
11	E Type -270 ~ 1000 °C	Temperature (Celsius)	+1000.0	-270.0
		Decimal Value	+32767	-8847
		2's Complement HEX	7FFF	DD71
12	R Type 0 ~ 1768 °C	Temperature (Celsius)	+1768.0	+0.0
		Decimal Value	+32767	+0
		2's Complement HEX	7FFF	0000
13	S Type 0 ~ 1768 °C	Temperature (Celsius)	+1768.0	+0.0
		Decimal Value	+32767	+0
		2's Complement HEX	7FFF	0000
14	B Type 0 ~ 1820 °C	Temperature (Celsius)	+1820.0	+0.0
		Decimal Value	+32767	+0
		2's Complement HEX	7FFF	0000
15	N Type -270 ~ 1300 °C	Temperature (Celsius)	+1300.0	-270.0
		Decimal Value	+32767	-6805
		2's Complement HEX	7FFF	E56B
16	C Type 0 ~ 2320 °C	Temperature (Celsius)	+2320.0	+0.0
		Decimal Value	+32767	+0
		2's Complement HEX	7FFF	0000
17	L Type -200 ~ 800 °C	Temperature (Celsius)	+800.0	-200.0
		Decimal Value	+32767	-8192
		2's Complement HEX	7FFF	E000
18	M Type -200 ~ 100 °C	Temperature (Celsius)	+100.0	-200.0
		Decimal Value	+16384	-32768
		2's Complement HEX	4000	8000

- **I-87018Z & I-7018Z** also support the types listed below:

Range Type Code (Hex)	Thermocouple Type	Data Format	Max Value	Min Value
19	L Type DIN43710 -200 ~ 900°C	Temperature (Celsius)	+900.0	-200.0
		Decimal Value	+32767	-7281
		2's Complement HEX	7FFF	E38F

- **I-7019, I-7019R, M-7019, M-7019R & I-87019R** also support the types:

Range Type Code (Hex)	Data Format	Max value	Min value	
08 (Default)	Input Range	+10.0 V	-10.0 V	
	Decimal Value	+32767	-32768	
	2's Complement HEX	7FFF	8000	
09	Input Range	+5.0 V	-5.0 V	
	Decimal Value	+32767	-32768	
	2's Complement HEX	7FFF	8000	
0A	Input Range	+1.0 V	-1.0 V	
	Decimal Value	+32767	-32768	
	2's Complement HEX	7FFF	8000	
0B	Input Range	+500.0 mV	-500.0 mV	
	Decimal Value	+32767	-32768	
	2's Complement HEX	7FFF	8000	
0C	Input Range	+150.0 mV	-150.0 mV	
	Decimal Value	+32767	-32768	
	2's Complement HEX	7FFF	8000	
0D*	Input Range (with 125 ohms resistor)	+20.0 mA	-20.0 mA	
	Decimal Value	+32767	-32768	
	2's Complement HEX	7FFF	8000	
19	L Type DIN43710 -200 ~ 900°C	Temperature (Celsius)	+900.0	-200.0
		Decimal Value	+32767	-7281
		2's Complement HEX	7FFF	E38F

- \* I-7019, I-7019R, M-7019, M-7019R & I-87019R: each channel can be configured to different Type Code.
- \* I-7019, I-7019R, M-7019, M-7019R & I-87019R can measure Code 0D current by jumper, they don't need to add an additional 125Ω resistor.

## I-7021

---

Range Type Code (Hex)	Data Format	Max Value	Min Value
30	Output Range	+20.0 mA	+0.0 mA
	Decimal Value	+32767	+0
	2's complement HEX	7FFF	0000
31	Output Range	+20.0 mA	+4.0 mA
	Decimal Value	+32767	+0
	2's complement HEX	7FFF	0000
32 (Default)	Output Range	+10.0 V	+0.0 V
	Decimal Value	+32767	+0
	2's complement HEX	7FFF	0000

## I-7022

---

Range Type Code (Hex)	Data Format	Max Value	Min Value
0	Output Range	+20.0 mA	+0.0 mA
	Decimal Value	+32767	+0
	2's complement HEX	7FFF	0000
1	Output Range	+20.0 mA	+4.0 mA
	Decimal Value	+32767	+0
	2's complement HEX	7FFF	0000
2 (Default)	Output Range	+10.0 V	+0.0 V
	Decimal Value	+32767	+0
	2's complement HEX	7FFF	0000

# I-7005, M-7005, I-87005

Range Type Code (Hex)	Thermistor Type	Data Format	Max Value	Min Value
60	PreCon Type III 10K @ 25 °C -35 ~ 115 °C	Temperature(Fahrenheit)	+240.00 °F	-030.00 °F
		2's complement HEX	7FFF	E000
		Ohms	+000539.4	+173600.0
61	Fenwell U 2K @ 25 °C -50 ~ 150 °C	Temperature(Celsius)	+150.00 °C	-050.00 °C
		2's complement HEX	7FFF	D556
		Ohms	+000037.2	+134020.0
62	Fenwell U 2K @ 25 °C 0 ~ 150 °C	Temperature(Celsius)	+150.00 °C	+000.00 °C
		2's complement HEX	7FFF	0000
		Ohms	+000037.2	+006530.0
63	YSI L Mix 100 @ 25 °C -80 ~ 100 °C	Temperature(Celsius)	+100.00 °C	-080.00 °C
		2's complement HEX	7FFF	999A
		Ohms	+000014.3	+014470.0
64	YSI L Mix 300 @ 25 °C -80 ~ 100 °C	Temperature(Celsius)	+100.00 °C	-080.00 °C
		2's complement HEX	7FFF	999A
		Ohms	+000035.8	+067660.0
65	YSI L Mix 1000 @ 25 °C -70 ~ 100 °C	Temperature(Celsius)	+100.00 °C	-070.00 °C
		2's complement HEX	7FFF	A667
		Ohms	+000106.4	+132600.0
66	YSI B Mix 2252 @ 25 °C -50 ~ 150 °C	Temperature(Celsius)	+150.00 °C	-050.00 °C
		2's complement HEX	7FFF	D556
		Ohms	+000041.8	+151000.0
67	YSI B Mix 3000 @ 25 °C -40 ~ 150 °C	Temperature(Celsius)	+150.00 °C	-040.00 °C
		2's complement HEX	7FFF	DDDE
		Ohms	+000055.6	+101000.0
68	YSI B Mix 5000 @ 25 °C -40 ~ 150 °C	Temperature(Celsius)	+150.00 °C	-040.00 °C
		2's complement HEX	7FFF	DDDE
		Ohms	+000092.7	+168300.0
69	YSI B Mix 6000 @ 25 °C -30 ~ 150 °C	Temperature(Celsius)	+150.00 °C	-030.00 °C
		2's complement HEX	7FFF	E667
		Ohms	+000111.5	+106200.0

Range Type Code (Hex)	Thermistor Type	Data Format	Max Value	Min Value
6A	YSI B Mix 10K @ 25 °C -30 ~ 150 °C	Temperature(Celsius)	+150.00 °C	-030.00 °C
		2's complement HEX	7FFF	E667
		Ohms	+000185.9	+177000.0
6B	YSI H Mix 10K @ 25 °C -30 ~ 150 °C	Temperature(Celsius)	+150.00 °C	-030.00 °C
		2's complement HEX	7FFF	E667
		Ohms	+000237.0	+135200.0
6C	YSI H Mix 30K @ 25 °C -10 ~ 200 °C	Temperature(Celsius)	+200.00 °C	-010.00 °C
		2's complement HEX	7FFF	F99A
		Ohms	+000186.7	+158000.0
70 ~ 77	User-defined -50 ~ 150 °C	Temperature(Celsius)	+150.00 °C	-050.00 °C
		2's complement HEX	7FFF	D556
		Ohms	+000000.0	+000000.0

- \* When using the User-defined Type, if the resistor is larger than 180000 ohms, it will be recognized as "lower than the standard range".
- \* Please refer to the Section 1.11 of the "I-7005/M-7005 User's Manual".

## I-8024

---

Range Type Code (Hex)	Data Format	Max Value	Min Value
30	Output Range	+20.0 mA	+0.0 mA
	Decimal Value	+32767	+0
33	Output Range	+10.0 V	-10.0 V
	Decimal Value	+32767	-32768

\* Each channel can be configured to different Range Type Code.

## I-87024, I-7024

---

Range Type Code (Hex)	Data Format	Max Value	Min Value
30	Output Range	+20.0 mA	+0.0 mA
	Decimal Value	+32767	+0
31	Output Range	+20.0 mA	+4.0 mA
	Decimal Value	+32767	+0
32	Output Range	+10.0 V	+0.0 V
	Decimal Value	+32767	+0
33 (Default)	Output Range	+10.0 V	-10.0 V
	Decimal Value	+32767	-32768
34	Output Range	+5.0 V	+0.0 V
	Decimal Value	+32767	+0
35	Output Range	+5.0 V	-5.0 V
	Decimal Value	+32767	-32768



## I-87022, I-87026

---

Range Type Code (Hex)	Data Format	Max Value	Min Value
0	Output Range	+20.0 mA	+0.0 mA
	Decimal Value	+32767	+0
1	Output Range	+20.0 mA	+4.0 mA
	Decimal Value	+32767	+0
2	Output Range	+10.0 V	+0.0 V
	Decimal Value	+32767	0

\* I-87022, I-87026: Each channel can be configured to different Range Type Code

---

# Appendix E : LANGUAGE REFERENCE

---

copyright AlterSys  
printed with permission

# ISaGRAF

Version 3.46

## LANGUAGE REFERENCE

### **AlterSys Inc.**

Information in this document is subject to change without notice and does not represent a commitment on the part of **AlterSys Inc.** The software, which includes information contained in any databases, described in this document is furnished under a license agreement or nondisclosure agreement and may be used or copied only in accordance with the terms of that agreement. It is against the law to copy the software except as specifically allowed in the license or nondisclosure agreement. No part of this manual may be reproduced in any form or by any means, electronic or mechanical, including photocopying and recording, for any purpose without the express written permission of **AlterSys Inc.**

© 1994 - 2002 **AlterSys Inc.** All rights reserved.  
Published in Canada by **AlterSys Inc.**

ISaGRAF is a registered trademark of **AlterSys Inc.**  
MS-DOS is a registered trademark of Microsoft Corporation.  
Windows is a registered trademark of Microsoft Corporation.  
Windows NT is a registered trademark of Microsoft Corporation.  
OS-9 and ULTRA-C are registered trademarks of Microware Corporation.  
VxWorks and Tornado are registered trademarks of Wind River Systems, Inc.

All other brand or product names are trademarks or registered trademarks of their respective holders.

## E.1 Project architecture

---

An ISaGRAF project is divided into several programming units called **programs**. The programs of the project are linked together in a tree-like architecture. Programs can be described using any of **SFC**, **FC (Flow Chart)**, **FBD**, **LD**, **ST** or **IL** graphic or literal languages.

### E.1.1 Programs

A **program** is a logical programming unit, which describes operations between **variables** of the process. Programs describe either **sequential** or **cyclic** operations. Cyclic programs are executed at each target system cycle. The execution of sequential programs follows the dynamic rules of either the **SFC** language or the **FC** language.

Programs are linked together in a hierarchy tree. Programs placed on the top of the hierarchy are activated by the system. Sub-programs (lower level of the hierarchy) are activated by their father. A program can be described with any of the available graphic or literal following languages:

**Sequential Function Chart (SFC)** for high level programming

**Flow Chart (FC)** for high level programming

**Function Block Diagram (FBD)** for cyclic complex operations

**Ladder Diagram (LD)** for boolean operations only

**Structured Text (ST)** for any cyclic operations

**Instruction List (IL)** for low level operations

The same program cannot mix several languages, except LD and FBD can be combined in one diagram.

### E.1.2 Cyclic and sequential operations

The hierarchy of programs is divided into four main **sections** or groups:

**Begin** programs executed at the beginning of each target cycle

**Sequential** programs following SFC or FC dynamic rules

**End** programs executed at the end of each target cycle

**Functions** set of non-dedicated sub-programs

Programs of the '**Begin**' or '**End**' sections describe cyclic operations, and are not time dependent. Programs of the '**Sequential**' section describe sequential operations, where the time variable explicitly synchronises basic operations. Main programs of the '**Begin**' section are systematically executed at the beginning of each run time cycle. Main programs of the '**End**' section are systematically executed at the end of each run time cycle. Main programs of the '**Sequential**' section are executed according to either the **SFC** or the **FC** dynamic rules.

Programs of the "**Functions**" section are sub-programs that can be called by any other program in the project. A program of the "**Function**" section can call another program of this section.

Main and child programs of the sequential section must be described with **SFC** or **FC** language. Programs of cyclic sections (**begin** and **end**) cannot be described with **SFC** or **FC** language. Any program of any section may own one or more sub-programs. Any program of the sequential section may own one or more **SFC** or **FC** child programs (according to its own programming language). Sub-programs cannot be described with **SFC** or **FC** language.

Programs of the **Begin** section are typically used to describe preliminary operations on input devices to build high level filtered variables. Such variables are frequently used by the programs of the **Sequential** section. Programs of the **End** section are typically used to describe security operations on the variables operated on by the **Sequential** section, before sending values to output devices.

### E.1.3 Child SFC and FC programs

Any **SFC** program of the sequential section may control other **SFC** programs. Such low-level programs are called **child SFC programs**. A **child SFC program** is a parallel program that can be started, killed, frozen or restarted by its parent program. The parent program and child program must both be described with the **SFC** language. A child SFC program may have local variables and defined words.

When a parent program starts a child **SFC** program, it puts an **SFC token** (activates) into each initial step of the child program. This command is described with the **GSTART** statement. When a parent program kills a child **SFC** program, it clears all the tokens existing in the **steps** of the child. Such a command is described with the **GKILL** statement.

When a parent program freezes a child **SFC** program, it suspends its execution. The suspended program can then be restarted using the **GRST** statement.

Any **FC** program of the sequential section may control other **FC** sub-programs. An **FC** father program is blocked (waits) during execution of an FC sub-program. It is not possible that simultaneous operations are done in father FC program and one of its FC sub-programs.

### E.1.4 Functions and sub-programs

A sub-program or a function execution is driven by its parent program. The execution of the parent program is suspended until the sub-program or the function ends:

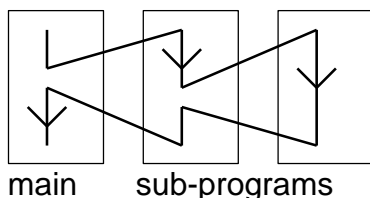

Any program of any section may have one or more sub-programs. A sub-program is owned by only one father program. A sub-program may have local variables and defines. Any language but **SFC** or **FC** can be used to describe a sub-program. Programs of the **"Functions"** section are sub-programs that can be called by any other program in the project. Unlike other sub-programs, they are not dedicated to one father program. A

program of the "**Function**" section can call another program of this section. A function can be located in the Library.

Warning: The ISaGRAF system does not support **recursive function calls**. A run time error will occur if a program of the "**Functions**" section is called by itself or by one of its called sub-program.

Warning: A function or sub-program does not "store" the local value of its local variables. A function or sub-program is not instantiated and so can not call function blocks.

The interface of a sub-program must be explicitly defined, with a **type** and a **unique name** for each of its calling or return parameter. In order to support the **ST** language convention, the return parameter must have the same name as the sub-program.

The following table shows how to set the value of the return parameter in the body of a sub-program, in the different languages:

**ST:** assign the return parameter using its name (the same name as the sub-program):

```
subprog_name := <expression>;
```

**IL:** the value of the current result (IL register) at the end of the sequence is stored in the return parameter:

```
LD 10
ADD 20 (* return parameter value = 30 *)
```

**FBD:** set the return parameter using its name:

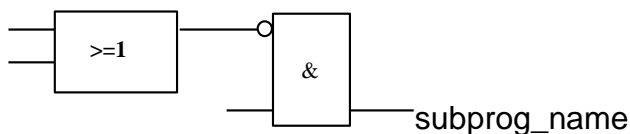

**LD:** use a coil symbol with the name of the return parameter:

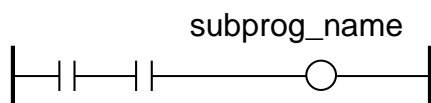

### E.1.5 Function blocks

Function blocks can use the languages: LD, FBD, ST or IL. Function blocks are instantiated. It means local variables of a function block are copied for each instance. When calling a block in a program, you actually call the instance of the block: the same code is called but the data used are the one which have been allocated for the instance. Values of the variables of the instance are stored from one cycle to the other.

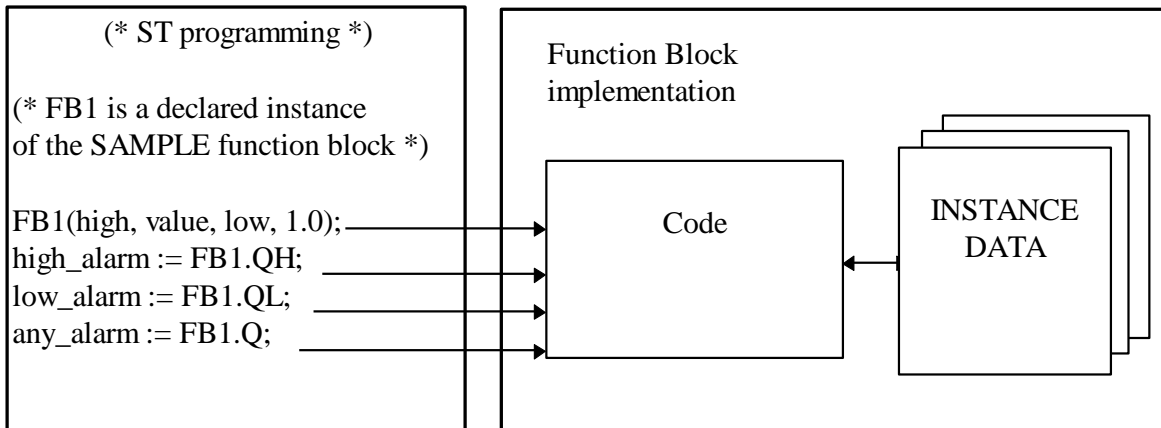

### Warnings:

- A function block written with one of the IEC languages can not call other function blocks: the instantiation mechanism only manages the local variables of the block itself. Here is the list of standard function blocks that you cannot use inside an IEC function block:  
SR, RS, R\_Trig, F\_Trig, SEMA, CTU, CTD, CTUD, TON, TOF, TP, CMP, StackInt, AVERAGE, HYSTER, LIM\_ALRM, INTEGRAL, DERIVATE, BLINK, SIG\_GEN
- For the same reason, you can not use Positive or Negative contact or coils, or Set and Reset coils.
- TSTART and TSTOP functions to start and stop timers cannot be used in a function block for 3.0x targets. It works since the 3.20 target.
- When you need loop in your function block, you must use local variable before doing the loop. See the example below:

This will not work:

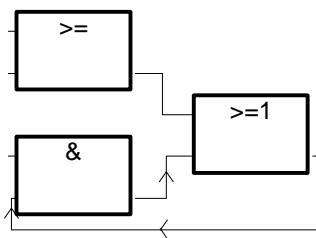

This is OK:

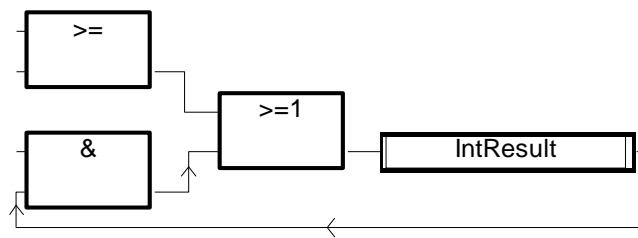

## E.1.6 Description language

A program can be described with any of the following graphic or literal languages:

- Sequential Function Chart (SFC)** for high level operations
- Flow Chart (FC)** for high level operations
- Function Block Diagram (FBD)** for cyclic complex operations
- Ladder Diagram (LD)** for boolean operations only
- Structured Text (ST)** for any cyclic operations
- Instruction List (IL)** for low level operations

The same program cannot mix several languages. The language used to describe a program is chosen when the program is created, and cannot be changed later on. The exception is that it is possible to combine FBD and LD in a single program.

### E.1.7 Execution rules

ISaGRAF is a **synchronous** system. All the operations are triggered by a clock. The basic duration of the clock is called the cycle timing:

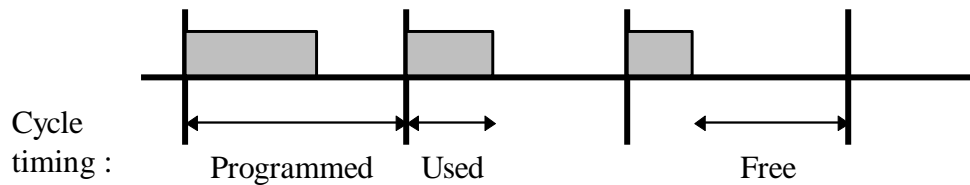

Basic operations processed during a target cycle are:

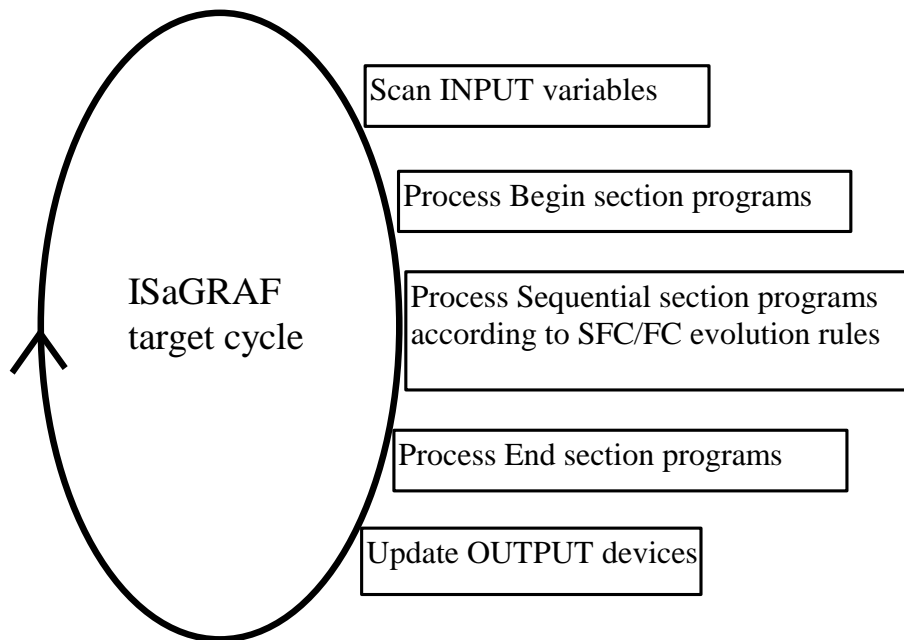

This system makes it possible to:

- guarantee that an input variable keeps the same value within a cycle,
- guarantee that an output device is not updated more than once in a cycle,
- work safely on the same global variable from different programs,
- estimate and control the response time of the complete application.



## E.2 Common objects

---

These are main features and common **objects** of the ISaGRAF programming database. Such objects can be used in any program written with any of the **SFC, FC, FBD, LD, ST** or **IL** languages.

### E.2.1 Basic types

Any constant, expression or variable used in a program (written in any language) must be characterised by a type. Type coherence must be followed in graphic operations and literal statements. These are the available basic types for programming objects:

**BOOLEAN:** logic (true or false) value  
**ANALOG:** integer or real (floating) continuous value  
**TIMER:** time value  
**MESSAGE:** character string

Note: Timers contain values less than one day and cannot be used to store dates.

### E.2.2 Constant expressions

Constant expressions are relative to one type. The same notation cannot be used to represent constant expressions of different types.

#### E.2.2.1 Boolean constant expressions

There are only two boolean constant expressions:

**TRUE** is equivalent to the integer value 1  
**FALSE** is equivalent to the integer value 0

"True" and "False" keywords are case insensitive.

#### E.2.2.2 Integer analog constant expressions

Integer constant expressions represent signed long integer (32 bit) values: from **-2147483647** to **+2147483647**. Integer analog constants may be expressed with one of the following **bases**. Integer constants must begin with a **prefix** that identifies the bases used:

Base	Prefix	Example
DECIMAL	(none)	-908
HEXADECIM	"16#"	16#1A2B3C4D
AL		
OCTAL	"8#"	8#1756402
BINARY	"2#"	2#1101_0001_0101_110

The underscore character ('\_') may be used to separate groups of digits. It has no particular significance, and is used to increase constant expression readability.

### E.2.2.3 Real analog constant expressions

Real analog constant expressions can be written with either **decimal** or **scientific** representation. The **decimal point** ('.') separates the integer and decimal parts. The decimal point must be used to differentiate a real constant expression from an integer one. The scientific representation uses the 'E' or 'F' letter to separate the **mantissa** part and the **exponent**. Exponent part of a real scientific expression must be a signed integer value from **-37** to **+37**. Below are examples of real analog constant expressions:

```
3.14159 -1.0E+12
+1.0    1.0F-15
-789.56 +1.0E-37
```

The expression "**123**" does not represent a real constant expression. Its correct real representation is "**123.0**".

### E.2.2.4 Timer constant expressions

Timer constant expressions represent time values from **0 second** to **23h59m59s999ms**. The lowest allowed unit is a millisecond. Standard time units used in constant expressions are:

**Hour**           The "h" letter must follow the number of hours  
**Minute**        The "m" letter must follow the number of minutes  
**Second**        The "s" letter must follow the number of seconds  
**Millisecond**    The "ms" letters must follow the number of milliseconds

The time constant expression must begin with "**T#**" or "**TIME#**" prefix. Prefixes and unit letters are case insensitive. Some units may not appear. These are examples of timer constant expressions:

```
T#1H450MS    1 hour, 450 milliseconds
time#1H3M    1 hour, 3 minutes
```

The expression "0" does not represent a time value, but an analog constant.

### E.2.2.5 Message string constant expressions

String or message constant expressions represent character strings. Characters must be preceded by a quote and followed by an apostrophe. For example:

```
'THIS IS A MESSAGE'
```

Warning: The apostrophe '"' character cannot be used within a string constant expression. A string constant expression must be expressed on one line of the program source code. Its length cannot exceed 255 characters, including spaces.

Empty string constant expression is represented by two apostrophes, with no space or tab character between them:

" (\* this is an empty string \*)

The special character dollar ('\$'), followed by other special characters, can be used in a string constant expression to represent a non-printable character:

Sequence	Meaning	ASCII (hexa)	Example
\$\$	'\$' character	16#24	'I paid \$\$5 for this'
'\$'	apostrophe	16#27	'Enter '\$Y\$' for YES'
\$L	line feed	16#0a	'next \$L line'
\$R	carriage return	16#0d	' llo \$R He'
\$N	new line	16#0d0a	'This is a line\$N'
\$P	new page	16#0c	'lastline \$P first line'
\$T	tabulation	16#09	'name\$Tsize\$Tdate'
\$hh (*)	any character	16#hh	'ABCD = \$41\$42\$43\$44'

(\*) "hh" is the hexadecimal value of the ASCII code for the expressed character.

## E.2.3 Variables

Variables can be **LOCAL** to one program, or **GLOBAL**. Local variables can be used by one program only. Global variables can be used in any program of the project. Variable names must conform to the following rules:

name cannot exceed **16** characters

first character must be a **letter**

following characters can be **letters**, **digits** or the underscore character

### E.2.3.1 Reserved keywords

A list of the reserved keywords is shown below. Such identifiers cannot be used to name a program, a variable or a "C" function or function block:

- A ANA, ABS, ACOS, ADD, ANA, AND, AND\_MASK, ANDN, ARRAY, ASIN, AT, ATAN,
- B BCD\_TO\_BOOL, BCD\_TO\_INT, BCD\_TO\_REAL, BCD\_TO\_STRING, BCD\_TO\_TIME, BOO, BOOL, BOOL\_TO\_BCD, BOOL\_TO\_INT, BOOL\_TO\_REAL, BOOL\_TO\_STRING, BOOL\_TO\_TIME, BY, BYTE,
- C CAL, CALC, CALCN, CALN, CALNC, CASE, CONCAT, CONSTANT, COS,
- D DATE, DATE\_AND\_TIME, DELETE, DINT, DIV, DO, DT, DWORD,
- E ELSE, ELSIF, EN, END\_CASE, END\_FOR, END\_FUNCTION, END\_IF, END\_PROGRAM, END\_REPEAT, END\_RESSOURCE, END\_STRUCT, END\_TYPE, END\_VAR, END\_WHILE, ENO, EQ, EXIT, EXP, EXPT,
- F FALSE, FEDGE, FIND, FOR, FUNCTION,
- G GE, GFREEZE, GKILL, GRST, GSTART, GSTATUS, GT,

I IF, INSERT, INT, INT\_TO\_BCD, INT\_TO\_BOOL, INT\_TO\_REAL, INT\_TO\_STRING,  
 INT\_TO\_TIME,  
 J JMP, JMPC, JMPCN, JMPN, JMPNC,  
 L LD, LDN, LE, LEFT, LEN, LIMIT, LINT, LN, LOG, LREAL, LT, LWORD,  
 M MAX, MID, MIN, MOD, MOVE, MSG, MUL, MUX,  
 N NE, NOT,  
 O OF, ON, OPERATE, OR, OR\_MASK, ORN,  
 P PROGRAM  
 R R, REDGE, READ\_ONLY, READ\_WRITE, REAL, REAL\_TO\_BCD, REAL\_TO\_BOOL,  
 REAL\_TO\_INT, REAL\_TO\_STRING, REAL\_TO\_TIME, REDGE, REPEAT,  
 REPLACE, RESSOURCE, RET, RETAIN, RETC, RETCN, RETN, RETNC,  
 RETURN, RIGHT, ROL, ROR,  
 S S, SEL, SHL, SHR, SIN, SINT, SQRT, ST, STN, STRING, STRING\_TO\_BCD,  
 STRING\_TO\_BOOL, STRING\_TO\_INT, STRING\_TO\_REAL, STRING\_TO\_TIME,  
 STRUCT, SUB, SYS\_ERR\_READ, SYS\_ERR\_TEST, SYS\_INITALL,  
 SYS\_INITANA, SYS\_INITBOO, SYS\_INITTMR, SYS\_RESTALL, SYS\_RESTANA,  
 SYS\_RESTBOO, SYS\_RESTTMR, SYS\_SAVALL, SYS\_SAVANA, SYS\_SAVBOO,  
 SYS\_SAVTMR, SYS\_TALLOWED, SYS\_TCURRENT, SYS\_TMAXIMUM,  
 SYS\_TOVERFLOW, SYS\_TRESET, SYS\_TWRITE, SYSTEM,  
 T TAN, TASK, THEN, TIME, TIME\_OF\_DAY, TIME\_TO\_BCD, TIME\_TO\_BOOL,  
 TIME\_TO\_INT, TIME\_TO\_REAL, TIME\_TO\_STRING, TMR, TO, TOD, TRUE,  
 TSTART, TSTOP, TYPE,  
 U UDINT, UINT, ULINT, UNTIL, USINT,  
 V VAR, VAR\_ACCESS, VAR\_EXTERNAL, VAR\_GLOBAL, VAR\_IN\_OUT,  
 VAR\_INPUT, VAR\_OUTPUT,  
 W WHILE, WITH, WORD,  
 X XOR, XOR\_MASK, XORN

All keywords beginning with an underscore ('\_') character are internal keywords and must not be used in textual instructions.

### E.2.3.2 Directly represented variables

ISaGRAF enables the use of **directly represented variables** in the source of the programs to represent a free channel. Free channels are the ones which are not linked to a declared I/O variable. The identifier of a directly represented variable always begins with "%" character.

Below are the naming conventions of a directly represented variable for a channel of a single board. "s" is the slot number of the board. "c" is the number of the channel.

<b>%IXs.c</b>	free channel of a boolean input board
<b>%IDs.c</b>	free channel of an integer input board
<b>%ISs.c</b>	free channel of a message input board
<b>%QXs.c</b>	free channel of a boolean output board
<b>%QDs.c</b>	free channel of an integer output board
<b>%QSs.c</b>	free channel of a message output board

Below are the naming conventions of a directly represented variable for a channel of a complex equipment. "**s**" is the slot number of the equipment. "**b**" is the index of the single board within the complex equipment. "**c**" is the number of the channel.

**%IXs.b.c** free channel of a boolean input board  
**%IDS.b.c** free channel of an integer input board  
**%ISS.b.c** free channel of a message input board  
**%QXs.b.c** free channel of a boolean output board  
**%QDS.b.c** free channel of an integer output board  
**%QSS.b.c** free channel of a message output board

Below are examples:

**%QX1.6** 6th channel of the board #1 (boolean output)  
**%ID2.1.7** 7th channel of the board #1 in the equipment #2 (integer input)

A directly represented variable cannot have the "**real**" data type.

### E.2.3.3 Boolean variables

Boolean means **logic**. Such variables can take one of the boolean values: **TRUE** or **FALSE**. Boolean variables are typically used in boolean expressions. Boolean variables can have one of the following **attributes**:

**Internal:** memory variable updated by the program  
**Constant:** read-only memory variable with an initial value  
**Input:** variable connected to an input device (refreshed by the system)  
**Output:** variable connected to an output device

Warning: When declaring a boolean variable, strings can be defined to replace 'true' and 'false' values during debug. Those strings cannot be used in the programs unless entered as '**defined words**' for the language.

### E.2.3.4 Analog variables

Analog means **continuous**. Such variables have signed integer or real (floating) values. Available formats for an analog variable are:

**Integer** 32 bit signed integer: from **-2147483647** to **+2147483647**  
**Real** standard IEEE 32 bit floating value (single precision)  
1 sign bit + 23 mantissa bits + 8 exponent bits

REAL analog exponent value cannot be less than **-37** or greater than **+37**. Analog variables can have one of the following **attributes**:

**Internal** memory variable updated by the program  
**Constant:** read-only memory variable with an initial value  
**Input** variable connected to an input device (refreshed by the system)

**Output** variable connected to an output device

Note: When a real variable is connected to an I/O device, the corresponding I/O driver operates the equivalent integer value.

Warning: Integer and real analog variables or constant expressions cannot be mixed in the same analog expression.

### E.2.3.5 Timer variables

Timer means **clock** or **counter**. Such variables have time values and are typically used in time expressions. A timer value cannot exceed **23h59m59s999ms** and cannot be negative.

Timer variables are stored in 32 bit words. The internal representation is a positive number of milliseconds.

Timer variables can have one of the following **attributes**:

**Internal** memory variable managed by the program, refreshed by ISaGRAF system

**Constant:** read-only memory variable with an initial value

Warning: Timer variables cannot have the INPUT or OUTPUT attributes.

Timer variables can be automatically refreshed by the ISaGRAF system. When a timer is **active**, its value is automatically increased according to the target system real time clock.

The following statements of the **ST** language can be used to control a timer:

**TSTART** starts automatic refresh of a timer

**TSTOP** stops automatic refresh of a timer

### E.2.3.6 Message string variables

Message or string variables contain character strings. The length of the string can change during process operations. The length of a message variable cannot exceed the capacity (maximum length) specified when the variable is declared. Message capacity is limited to 255 characters. Message variables can have one of the following **attributes**:

**Internal** memory variable updated by the program

**Constant:** read-only memory variable with an initial value

**Input** variable connected to an input device (refreshed by the system)

**Output** variable connected to an output device

String variables can contain any character of the standard ASCII table (ASCII code from **0** to **255**). The null character can exist in a character string. Some "C" functions of the standard ISaGRAF library will not correctly operate messages which contain null (**0**) characters.

## E.2.4 Comments

Comments may be freely inserted in literal languages such as **ST** and **IL**. A comment must begin with the special characters "(" and terminate with the characters ")". Comments can be inserted anywhere in a **ST** program, and can be written on more than one line.

These are examples of comments:

```
counter := ivalue; (* assigns the main counter *)
(* this is a comment expressed
on two lines *)
c := counter (* you can put comments anywhere *) + base_value + 1;
```

Interleave comments cannot be used. This means that the "(" characters cannot be used within a comment.

Warning: The IL language only accepts comments as the last component of an instruction line.

## E.2.5 Defined words

The ISaGRAF system allows the re-definition of constant expressions, true and false boolean expressions, keywords or complex **ST** expressions. To achieve this, an **identifier** name has to be given to the corresponding expression. For example:

```
YES    is  TRUE
PI     is  3.14159
OK     is  (auto_mode AND NOT (alarm))
```

When such equivalence is defined, its **identifier** can be used anywhere in an **ST** program to replace the attached expression. This is an example of **ST** programming using defines:

```
If OK Then
  angle := PI / 2.0;
  isdone := YES;
End_if;
```

Defined words can be **LOCAL** to one program, **GLOBAL**, or **COMMON**.

Local defined words can be used by only one program.

Global defined words can be used in any program of the project.

Common defined words can be used in any program of any project.

Note that common defined can be stored separately with the Archive manager.

Warning: When the same identifier is defined twice with different **ST** equivalencies, the last defined expression is used. For example:

```
Define:    OPEN      is      FALSE
          OPEN      is      TRUE

means:    OPEN      is      TRUE
```

Naming defined words must conform to following rules:

- name cannot exceed **16** characters
- first character must be a **letter**
- following characters can be **letters**, **digits** or underscore ('\_') character

Warning: A defined word can not use a defined word in its definition, for example, you can not have:

PI is 3.14159

PI2 is PI\*2

write the complete equivalence using constants or variables and operations:

PI2 is 6.28318



## E.3 SFC language

---

Sequential Function Chart (SFC) is a **graphic** language used to describe **sequential operations**. The process is represented as a set of well-defined **steps**, linked by **transitions**. A **boolean condition** is attached to each transition. **Actions** within the steps are detailed by using other languages (**ST**, **IL**, **LD** and **FDB**).

### E.3.1 SFC chart main format

An SFC program is a graphic set of **steps** and **transitions**, linked together by **oriented links**. Multiple connection links are used to represent divergences and convergences. Some parts of the complete program may be separated and represented in the main chart by a single symbol, called **macro steps**. The basic **graphic rules** of the SFC are:

- A step cannot be followed by another step
- A transition cannot be followed by another transition

### E.3.2 SFC basic components

The basic components (graphic symbols) of the SFC language are: steps and initial steps, transitions, oriented links, and jumps to a step.

#### E.3.2.1 Steps and initial steps

A step is represented by a single **square**. Each step is **referenced** by a number, written in the step square symbol. A main description of the step is written in a rectangle linked to the step symbol. This description is a **free comment** (not part of the programming language). The above information is called the **Level 1** of the step:

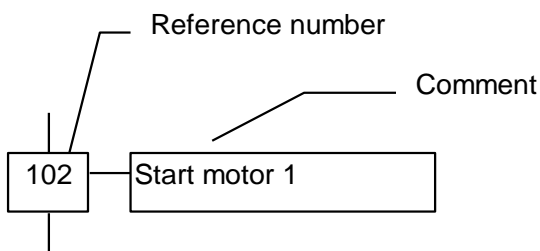

At run time, a token indicates that the step is active:

Active step:

Inactive step:

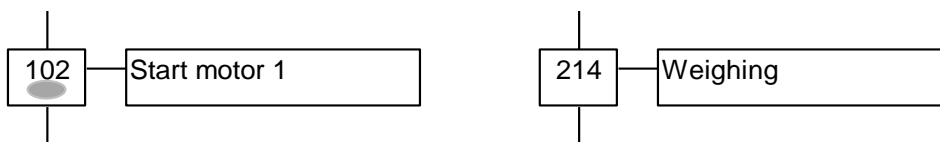

The **initial situation** of an SFC program is expressed with **initial steps**. An initial step has a **double-bordered** graphic symbol. A token is automatically placed in each initial step when the program is started.

Initial step:

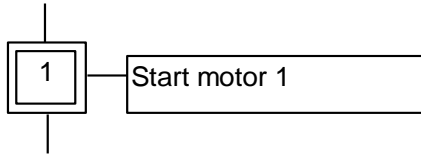

An SFC program must contain **at least one** initial step.

These are the attributes of a step. Such fields may be used in any of the other languages:

**GSnnn.x** activity of the step (boolean value)

**GSnnn.t** activation duration of the step (time value)

(where **nnn** is the reference number of the step)

### E.3.2.2 Transitions

Transitions are represented by a small horizontal bar that crosses the connection link. Each transition is **referenced** by a number, written next to the transition symbol. A main description of the transition is written on the right side of the transition symbol. This description is a **free comment** (not part of the programming language). The above information is called the **Level 1** of the transition:

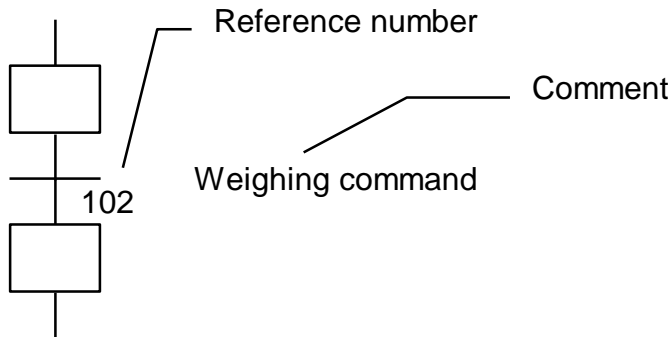

### E.3.2.3 Oriented links

Single lines are used to link steps and transitions. These are oriented links. When the orientation is not explicitly given, the link is oriented from the top to the bottom.

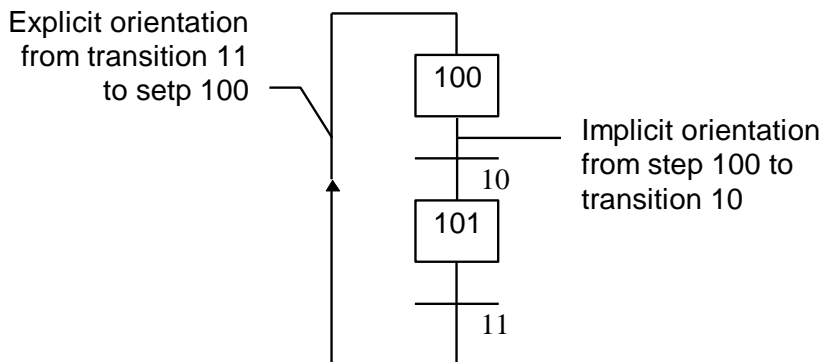

### E.3.2.4 Jump to a step

Jump symbols may be used to indicate a connection link from a transition to a step, without having to draw the connection line. The jump symbol must be referenced with the number of the destination step:

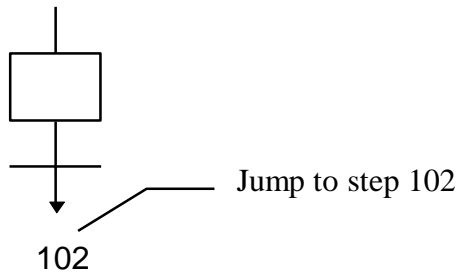

A jump symbol cannot be used to represent a link from a step to a transition. Examples of jumps - the following charts are equivalent:

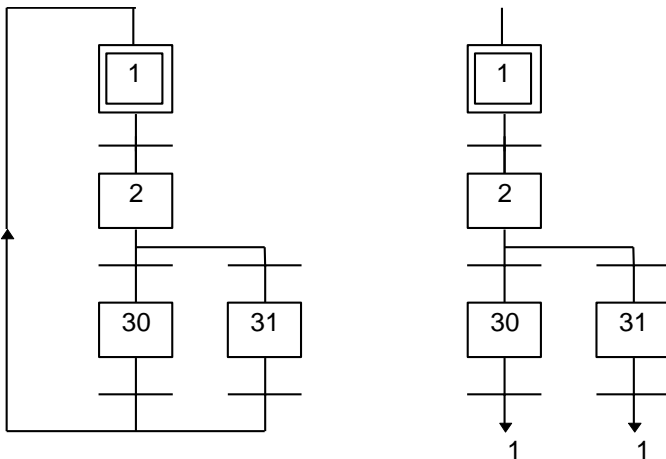

## E.3.3 Divergences and convergences

Divergences are **multiple connection links** from one SFC symbol (step or transition) to many other SFC symbols. Convergences are multiple connection links from more than one SFC symbols to one other symbol. Divergences and convergences can be single or double.

### E.3.3.1 single divergences

A single divergence is a multiple link from one step to many transitions. It allows the active token to pass into one of a number of branches. A single convergence is a multiple link from many transitions to the same step. A single convergence is generally used to group the SFC branches which were started on a single divergence. Single divergences and convergences are represented by single horizontal lines.

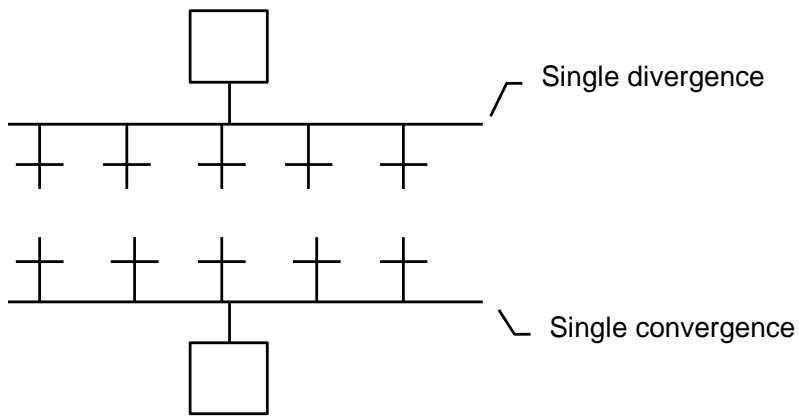

**Warning:** The conditions attached to the different transitions at the beginning of a single divergence are **not implicitly exclusive**. The exclusivity has to be explicitly detailed in the conditions of the transitions to ensure that only one token progresses in one branch of the divergence at run time. Below is an example of single divergence and convergence:

(\* SFC program with single divergence and convergence \*)

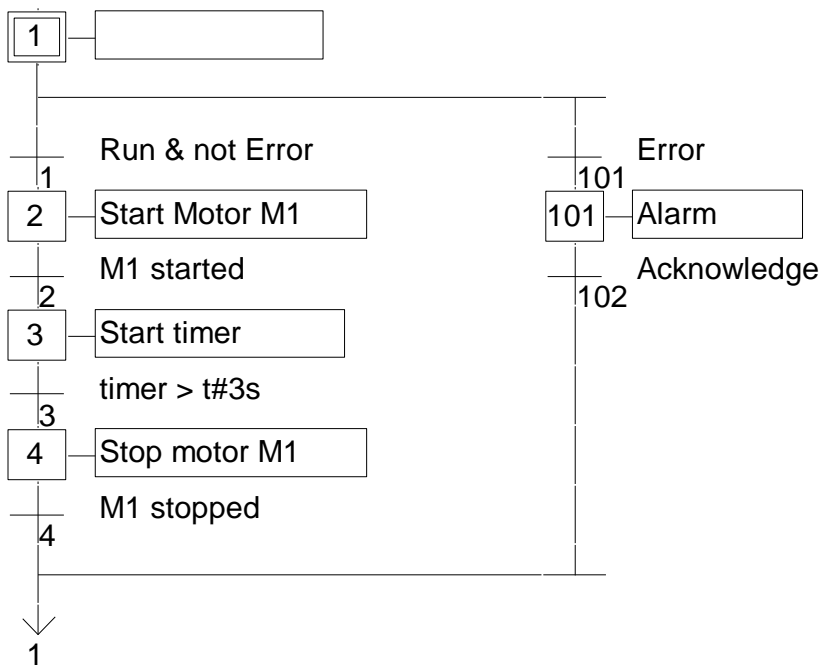

### E.3.3.2 Double divergences

A double divergence is a multiple link from one transition to many steps. It corresponds to parallel operations of the process. A double convergence is a multiple link from many steps to the same transition. A double convergence is generally used to group the SFC branches started on a double divergence. Double divergences and convergences are represented by double horizontal lines.

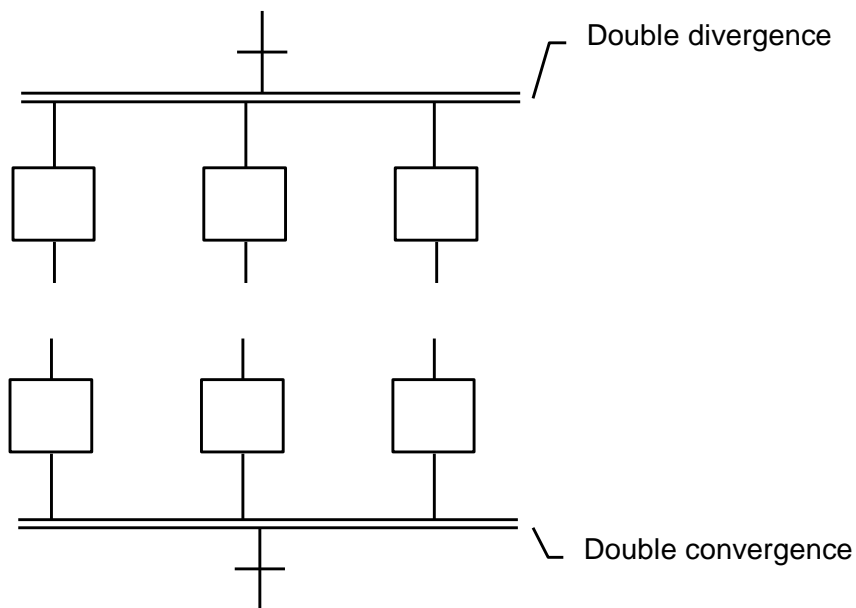

Example of double divergence and convergence:

(\* SFC program with double divergence and convergence \*)

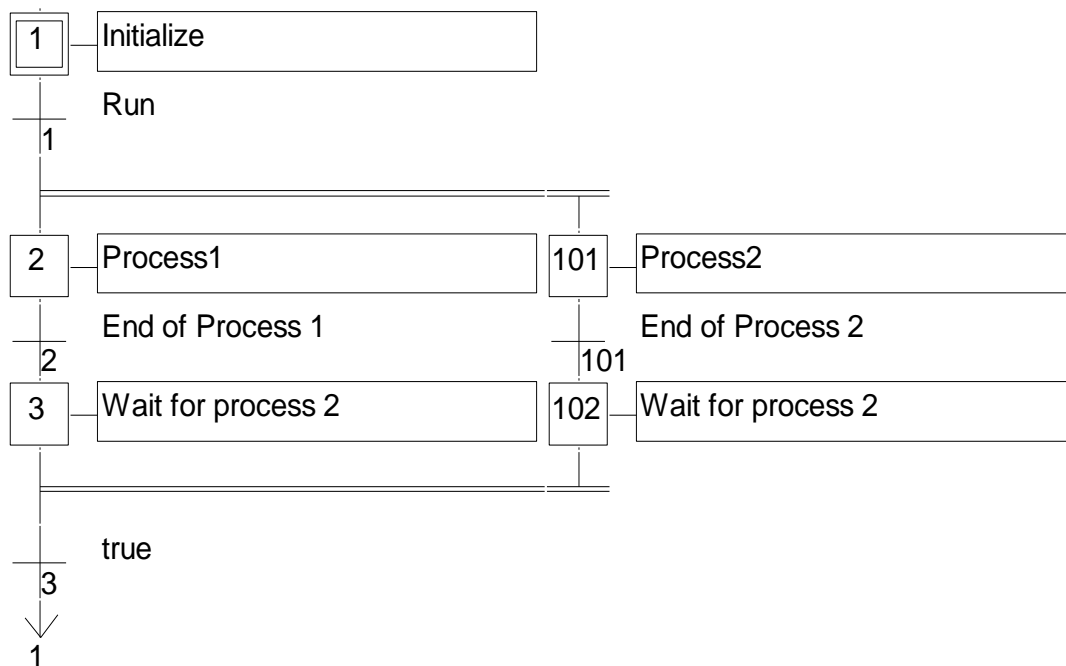

### E.3.4 Macro steps

A macro step is a unique representation of a unique group of steps and transitions. The body of the macro step is described separately, elsewhere in the same SFC program. It appears as a single symbol in the main SFC chart. This is the symbol used for a macro step:

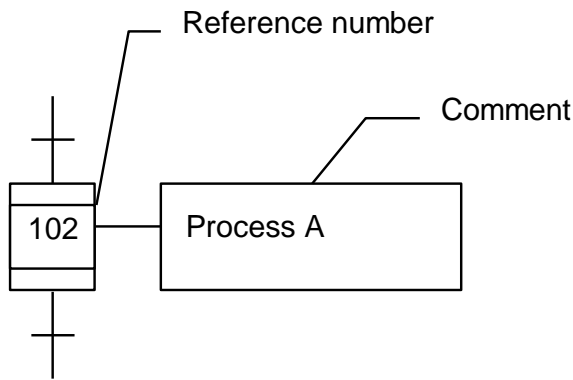

The reference number written in the macro step symbol is the reference number of the first step in the body of the macro step. The macro step body must begin with a **beginning step** and terminate with an **ending step**. The chart must be self-contained. A beginning step has no upper link (no backward transition). An ending step has no lower link (no forward transition). A macro step symbol may be put in the body of another macro step.

Warning: Because macro step is a **unique** set of steps and transitions, the same macro step cannot be used more than once in an SFC program.

Example of macro step:

(\* SFC program with macro step \*)  
 (\* Main chart \*) (\* Body of the macro step \*)

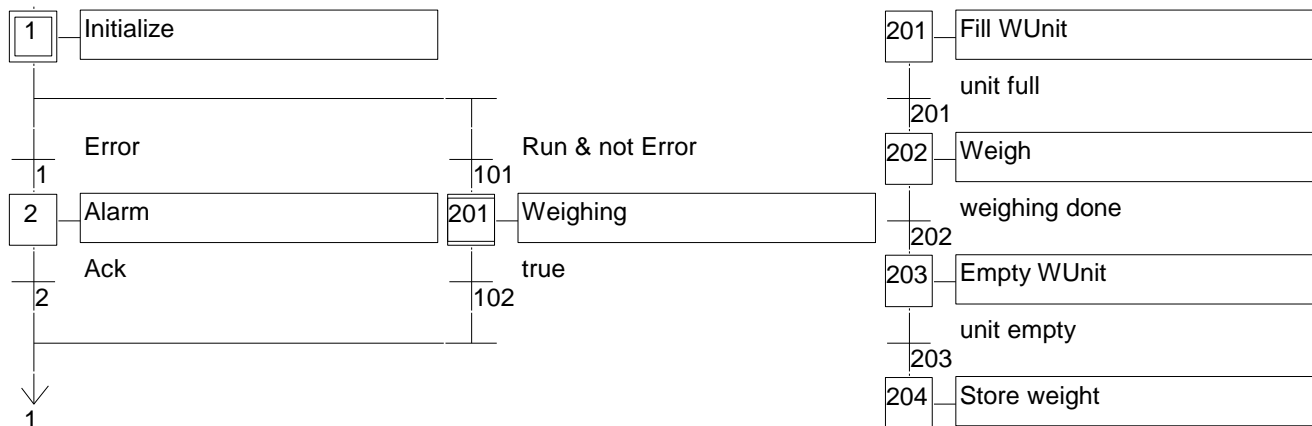

### E.3.5 Actions within the steps

The **level 2** of an SFC step is the detailed description of the **actions** executed **during the step activity**. This description is made by using **SFC literal features**, and other languages such as Structured Text (**ST**). The basic types of actions are:

- Boolean actions
- Pulse actions programmed in ST
- Non-stored actions programmed in ST
- SFC actions

Several actions (with same or different types) can be described in the same step. The special features that enable the use of any of the other languages are:

- Calling sub-programs
- Instruction List (IL) language convention

### E.3.5.1 Boolean actions

Boolean actions assign a boolean variable with the activity of the step. The boolean variable can be an output or an internal. It is assigned each time the step activity starts or stops. This is the syntax of the basic boolean actions:

**<boolean\_variable> (N) ;** assigns the step activity signal to the variable

**<boolean\_variable> ;** same effect (N attribute is optional)

**/ <boolean\_variable> ;** assigns the negation of the step activity signal to the variable

Other features are available to set or reset a boolean variable, when the step becomes active. This is the syntax of set and reset boolean actions:

**<boolean\_variable> (S) ;** sets the variable to TRUE when the step activity signal becomes TRUE

**<boolean\_variable> (R) ;** resets the variable to FALSE when the step activity signal becomes TRUE

The boolean variable must be an OUTPUT or an INTERNAL. The following SFC programming leads to the following behaviour:

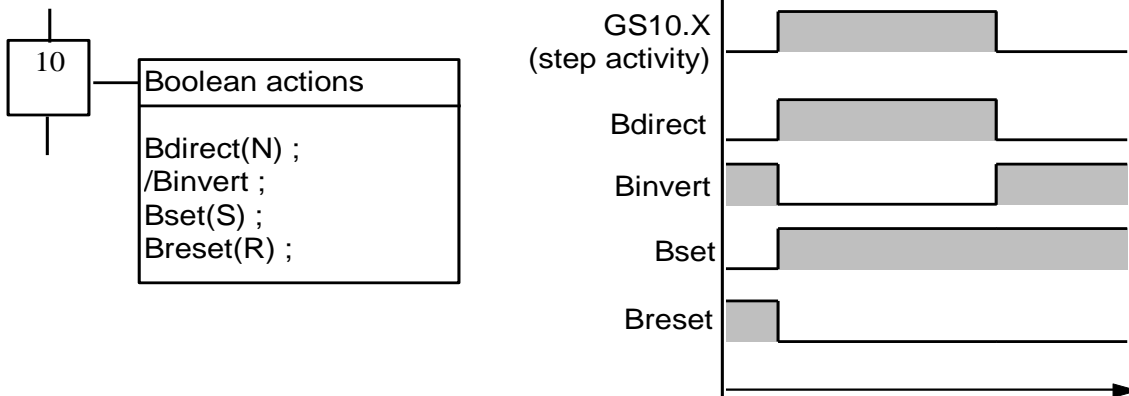

Example of boolean actions:

(\* SFC program using BOOLEAN actions \*)

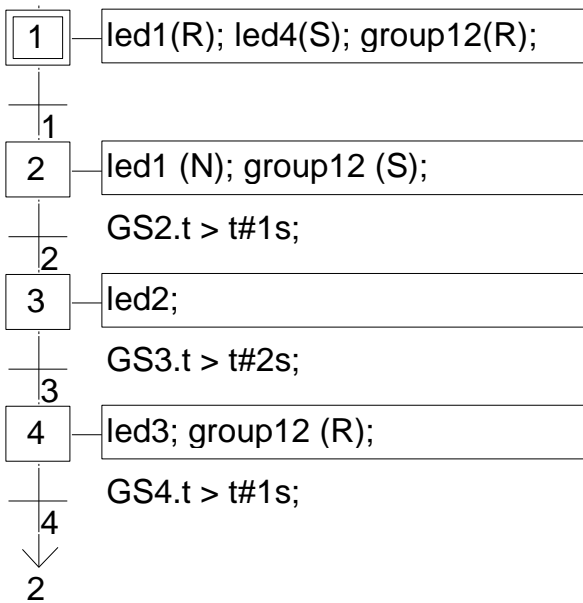

### E.3.5.2 Pulse actions

A pulse action is a list of ST or IL instructions, which are executed only **once** at the **activation** of the step. Instructions are written according to the following SFC syntax:

```

ACTION (P) :
(* ST statements *)
END_ACTION ;
  
```

The following shows the results of a pulse action:

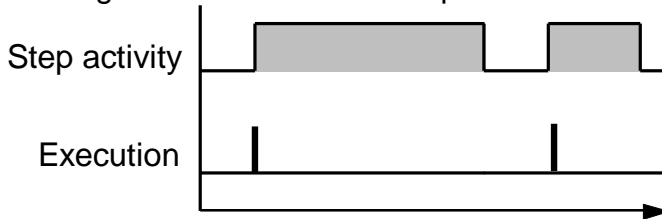

Example of pulse action:

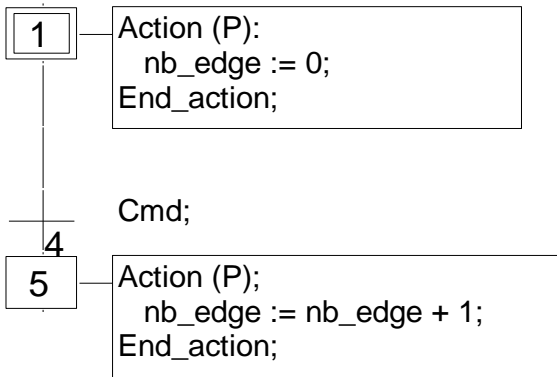



### E.3.5.3 Non-stored actions

A non-stored (normal) action is a list of ST or IL instructions which are executed **at each cycle** during the whole **active** period of the step. Instructions are written according to the following SFC syntax:

```
ACTION (N) :  
  (* ST statements *)  
END_ACTION ;
```

The following is the results of a non-stored action:

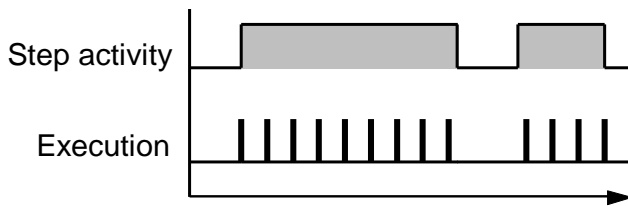

Example of non-stored action:

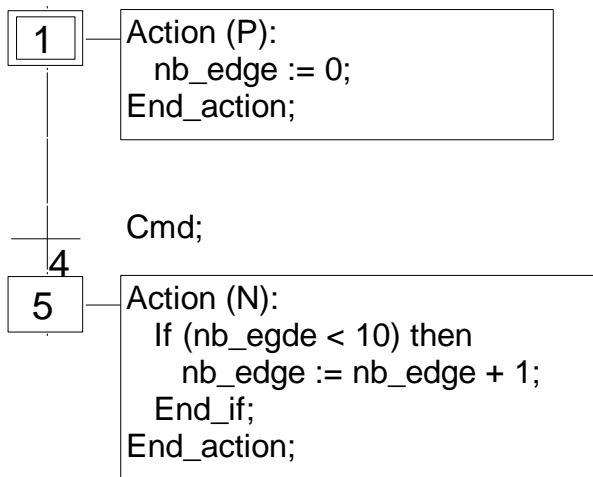

### E.3.5.4 SFC actions

An SFC action is a child SFC sequence, started or killed according to the change of the step activity signal. An SFC action can have the **N** (Non stored), **S** (Set), or **R** (Reset) qualifier. This is the syntax of the basic SFC actions:

- <child\_prog> (N);** starts the child sequence when the step becomes active, and kills the child sequence when the step becomes inactive
- <child\_prog> ;** same effect (N attribute is optional)
- <child\_prog> (S);** starts the child sequence when the step becomes active. Nothing is done when the step becomes inactive
- <child\_prog> (R);** kills the child sequence when the step becomes active. Nothing is done when the step becomes inactive

The SFC sequence specified as an action must be a **child SFC program** of the program currently being edited. Note that using the **S** (Set) or **R** (Reset) qualifiers for an SFC action has exactly the same effect as the **GSTART** and **GKILL** statements, programmed in an **ST** pulse action.

Below is an example of an SFC action. The main SFC program is named **Father**. It has two SFC children, called **SeqMlx** and **SeqPump**. The SFC programming of the father SFC program is:

(\* SFC program using SFC actions \*)

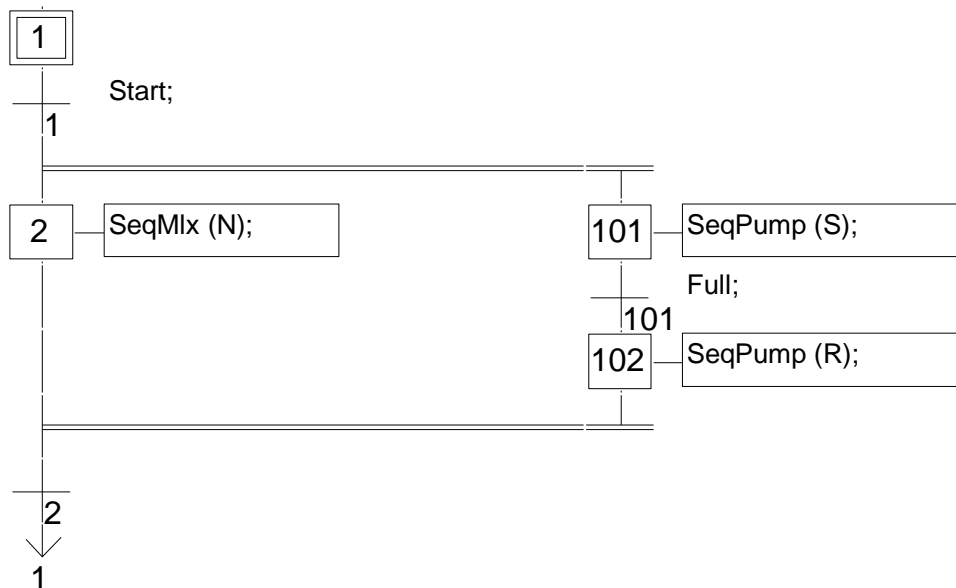

### E.3.5.5 Calling function and function blocks from an action

Sub-programs, functions or function blocks (written in ST, IL, LD or FBD language) or "C" functions and "C" function blocks, can be directly called from an SFC action block, based on the following syntax:

For sub-programs, functions and "C" functions:

```

ACTION (P) :
  result := sub_program ( ) ;
END_ACTION;
  
```

or

```

ACTION (N) :
  result := sub_program ( ) ;
END_ACTION;
  
```

For function blocks in "C" or in ST, IL, LD, FBD:

```

ACTION (P) :
  Fbinst(in1, in2);
  result1 := Fbinst.out1;
  result2 := Fbinst.out2;
  
```

```
END_ACTION;
```

or

```
ACTION (N) :  
  Fbinst(in1, in2);  
  result1 := Fbinst.out1;  
  result2 := Fbinst.out2;  
END_ACTION;
```

Detailed syntax can be found in the ST language section.  
Example of a sub-program call in action blocks:

(\* SFC program with a sub-program call in an action block \*)

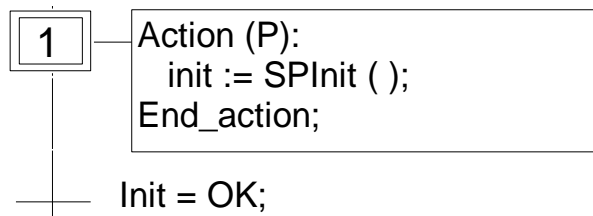

### E.3.5.6 IL convention

Instruction List (IL) programming may be directly entered in an SFC action block, based on the following syntax:

```
ACTION (P) :          (* or N *)  
#info=IL  
  <instruction>  
  <instruction>  
  ....  
#endinfo  
END_ACTION;
```

The special "#info=IL" and "#endinfo" keywords must be entered exactly this way, and **are case sensitive**. Space or tab characters cannot be inserted into, after or before the keywords.  
Below is an example of an IL program in an action block:

(\* SFC program with an IL sequence in an action block \*)

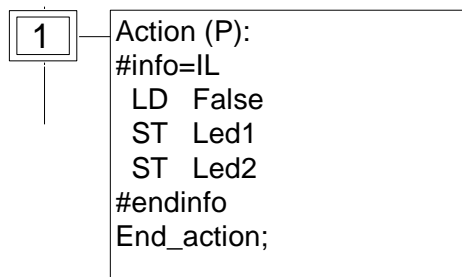

## E.3.6 Conditions attached to transitions

At each transition, a **boolean expression** is attached that conditions the clearing of the transition. The condition is usually expressed with ST language or using the LD language (Quick LD editor). This is the **Level 2** of the transition. Other structures may, however, be used:

- ST language convention
- LD language convention
- IL language convention
- Calling function from a transition

Warning: When no expression is attached to the transition, the default condition is **TRUE**.

### E.3.6.1 ST convention

The **Structured Text** (ST) language can be used to describe the **condition** attached to a transition. The complete expression must have **boolean** type and must be terminated by a **semicolon**, according to the following syntax:

< boolean\_expression > ;

The expression may be a TRUE or FALSE constant expression, a single input or an internal boolean variable, or a combination of variables that leads to a boolean value. Below is an example of ST programming for transitions:

(\* SFC program with ST programming for transitions \*)



—+— Run & not Error;

### E.3.6.2 LD convention

The **Ladder Diagram** (LD) language can be used to describe the **condition** attached to a transition. The diagram is composed of only one rung with one coil. The coil value represents the transition value. Below is an example of LD programming for transitions:



Run Error

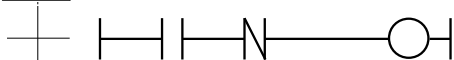

### E.3.6.3 IL convention

Instruction List (IL) programming may be directly used to describe an SFC transition, according to the following syntax:

```
#info=IL
<instruction>
<instruction>
....
#endinfo
```

The value contained by the **current result** (IL register) at the end of the IL sequence causes the resulting of the condition to be attached to the transition:

```
current result = 0    →    condition is FALSE
current result <> 0 →    condition is TRUE
```

The special "#info=IL" and "#endinfo" keywords must be entered exactly this way, and **are case sensitive**. Space or tab characters cannot be inserted into, after or before the keywords. Below is an example of IL programming for transitions:

(\* SFC program with an IL program for transitions \*)

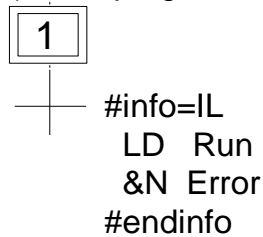

### E.3.6.4 Calling functions from a transition

Any sub-program or a function (written in FBD, LD, ST or IL language), or a "C" function can be called to evaluate the condition attached to a transition, according to the following syntax:

```
< sub_program > ( ) ;
```

The value returned by the sub-program or the function must be boolean and yields the resulting condition:

```
return value = FALSE →    condition is FALSE
return value = TRUE  →    condition is TRUE
```

Example of a sub-program called in a transition:

(\* SFC program with sub-program call for transitions \*)



### E.3.7 SFC dynamic rules

The **five** dynamic rules of the SFC language are:

 Initial situation

The initial situation is characterised by the **initial steps** which are, by definition, in the active state at the beginning of the operation. **At least one** initial step must be present in each SFC program.

 Clearing of a transition

A transition is either **enabled** or **disabled**. It is said to be enabled when all immediately preceding steps linked to its corresponding transition symbol are **active**, otherwise it is disabled. A transition cannot be **cleared** unless:

- it is enabled, and
- the associated transition condition is true.

 Changing of state of active steps

The clearing of a transition simultaneously leads to the active state of the immediately following steps and to the inactive state of the immediately preceding steps.

 Simultaneous clearing of transitions

Double lines may be used to indicate transitions which have to be cleared simultaneously. If such transitions are shown separately, the activity state of preceding steps (GSnnn.x) can be used to express their conditions.

 Simultaneous activation and deactivation of a step

If, during operation, a step is simultaneously activated and deactivated, priority is given to the activation.

### E.3.8 SFC program hierarchy

The ISaGRAF system enables the description of the vertical structure of SFC programs. SFC programs are organised in a **hierarchy tree**. Each SFC program can control (start, kill...) other SFC programs. Such programs are called **children** of the SFC program which controls them. SFC programs are linked together into a main **hierarchy tree**, using a "**father - child**" relation:

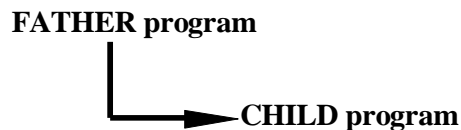

The basic rules implied by the hierarchy structure are:

- SFC programs which have no father are called "**main**" SFC programs
- Main SFC programs are activated by the system when the application starts
- A program can have several child programs
- A child of a program cannot have more than one father
- A child program can only be controlled by its father
- A program cannot control the children of one of its own children

The basic actions that a father SFC program can take to control its child program are:

Start (**GSTART**) Starts the child program: activates each of its initial steps. Children of this child program are not automatically started.

Kill (**GKILL**) Kills the child program by deactivating each of its active steps. All the children of the child program are also killed.

Freeze (**GFREEZE**) Suspends the execution of the program (deactivates actions of each of the active steps and suspend transition calculation), and memorises the status of the program steps so the program can be restarted. All the children of the child program are also frozen.

Restart (**GRST**) Restarts a frozen SFC program by reactivating all the suspended steps. Children of the program are not automatically restarted.

Get status (**GSTATUS**) Gets the current status (active, inactive or frozen) of a child program.

## E.4 Flow Chart language

---

**Flow Chart (FC)** is a graphic language used to describe **sequential operations**. A Flow Chart diagram is composed of **Actions** and **Tests**. Between Actions and test are **oriented links** representing data flow. Multiple connection links are used to represent divergences and convergences. Actions and Tests can be described with ST, LD or IL languages. Functions and Function blocks of any language (except SFC) can be called from actions and tests. A Flow Chart program can call another Flow Chart program. The called FC program is a **sub-program** of the calling FC program.

### E.4.1 FC components

Below are graphic components of the Flow Chart language:

▬ **Beginning of FC chart**

A "**begin**" symbol must appear at the beginning of a Flow Chart program. It is unique and cannot be omitted. It represents the initial state of the chart when it is activated. Below is the drawing of a "begin" symbol:

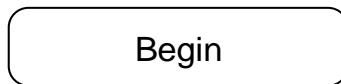

The "Begin" symbol always has a connection (on the bottom) to the other objects of the chart. A flow chart is not valid if no connection is drawn from "Begin" to another object.

▬ **Ending of FC chart**

An "**end**" symbol must appear at the end of a Flow Chart program. It is unique and cannot be omitted. It is possible that no connection is drawn to the "End" symbol (always looping chart), but "End" symbol is still drawn anyway at the bottom of the chart. It represents the final state of the chart, when its execution has been completed. Below is the drawing of an "end" symbol:

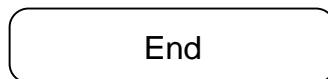

The "End" symbol generally has a connection (on the top) to the other objects of the chart. A flow chart may have no connection to the "End" object (always looping chart). The "End" object is still visible at the bottom of the chart in this case.

▬ **FC flow links**

A flow **link** is a line that represents a flow between two points of the diagram. A link is always terminated by an arrow. Below is the drawing of a flow link:



Two links cannot start from the same source connection point.

▬ **FC actions**



An **action** symbol represents actions to be performed. An action is identified by a number and a name. Below is the drawing of an "action" symbol:

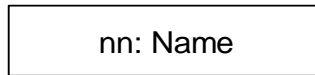

Two different objects of the same chart cannot have the same name or logical number. Programming language for an action can be ST, LD or IL. An action is always connected with links, one arriving to it, one starting from it.

▬ **FC conditions**

A **condition** represents a boolean **test**. A condition is identified by a number and a name. According to the evaluation of attached ST, LD or IL expression, the flow is directed to "YES" or "NO" path. Below are the possible drawings for a condition symbol:

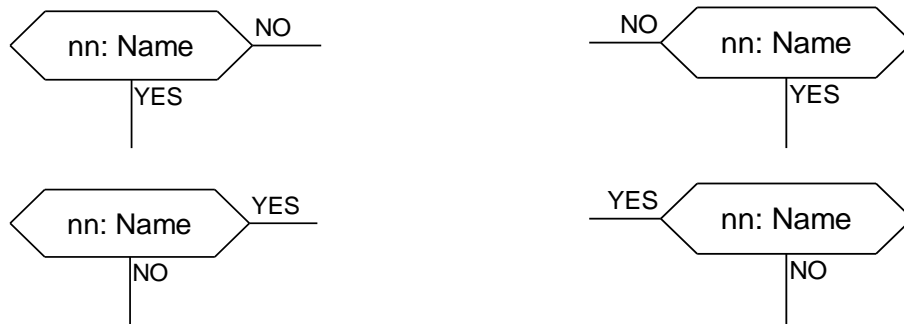

Two different objects of the same chart cannot have the same name or logical number. The programming of a test is either

- an expression in ST, or
- a single rung in LD, with no symbol attached to the unique coil, or
- several instructions in IL. The IL register (or current result) is used to evaluate the condition.

When programmed in ST text, the expression may optionally be followed by a semicolon. When programmed in LD, the unique coil represents the condition value. A condition equal to:

- 0 or FALSE directs the flow to NO
- 1 or TRUE directs the flow to YES

A test is always connected with an arriving link, and both forward connections must be defined.

▬ **FC sub-program**

The system enables the description of the vertical structure of FC programs. FC programs are organised in a **hierarchy tree**. Each FC program can call other FC programs. Such a program is called a **child program** of the FC program which calls them. FC programs which call FC sub-programs are called **father program**. FC programs are linked together into a main hierarchy tree, using a "father - child" relation:

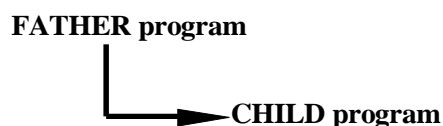

A **sub-program** symbol in a Flow Chart represents a call to a Flow Chart sub-program. Execution of the calling FC program is suspended till the sub-program execution is complete. A Flow Chart sub-program is identified by a number and a name, as other programs, functions or function blocks. Below is the drawing of a "sub-program call" symbol:



Two different objects of the same chart cannot have the same logical number. The basic rules implied by the FC hierarchy structure are:

- FC programs which have no father are called main FC programs.
- Main FC programs are activated by the system when the application starts
- A program can have several child programs
- A child of a program cannot have more than one father
- A child program can be called only by its father
- A program cannot call the children of one of its own children

The same sub-program may appear several times in the father chart. A Flow Chart sub-program call represents the complete execution of the sub chart. The father chart execution is suspended during the child chart is performed. The sub-program calling blocks must follow the same connection rules as the ones defined for action.

⇒ **FC I/O specific action**

An **I/O specific action** symbol represents actions to be performed. As other actions, an I/O specific action is identified by a number and a name. The same semantic is used on standard actions and I/O specific actions. The aim of I/O specific actions is only to make the chart more readable and to give focus on non-portable parts of the chart. Using I/O specific actions is an optional feature. Below is the drawing of an "I/O specific action" symbol:

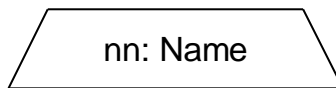

I/O specific blocks have exactly the same behaviour as standard actions. This covers their properties, ST, LD or IL programming, and connection rules.

⇒ **FC connectors**

**Connectors** are used to represent a link between two points of the diagram without drawing it. A connector is represented as a circle and is connected to the source of the flow. The drawing of the connector is completed, on the appropriate side (depending on the direction of the data flow), by the identification of the target point (generally the name of the target symbol). Below is the standard drawing of a connector:



A connector always targets a defined Flow Chart symbol. The destination symbol is identified by its logical number.

⇒ **FC comments**

A **comment** block contains text that has no sense for the semantic of the chart. It can be inserted anywhere on an unused space of the Flow Chart document window, and is used to document the program. Below is the drawing of a "comment" symbol:

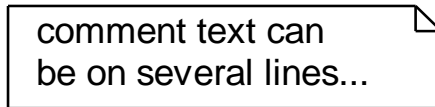

### E.4.2 FC complex structures

This section shows **complex structure** examples that can be defined in a Flow Chart diagram. Such structures are combinations of basic objects linked together.

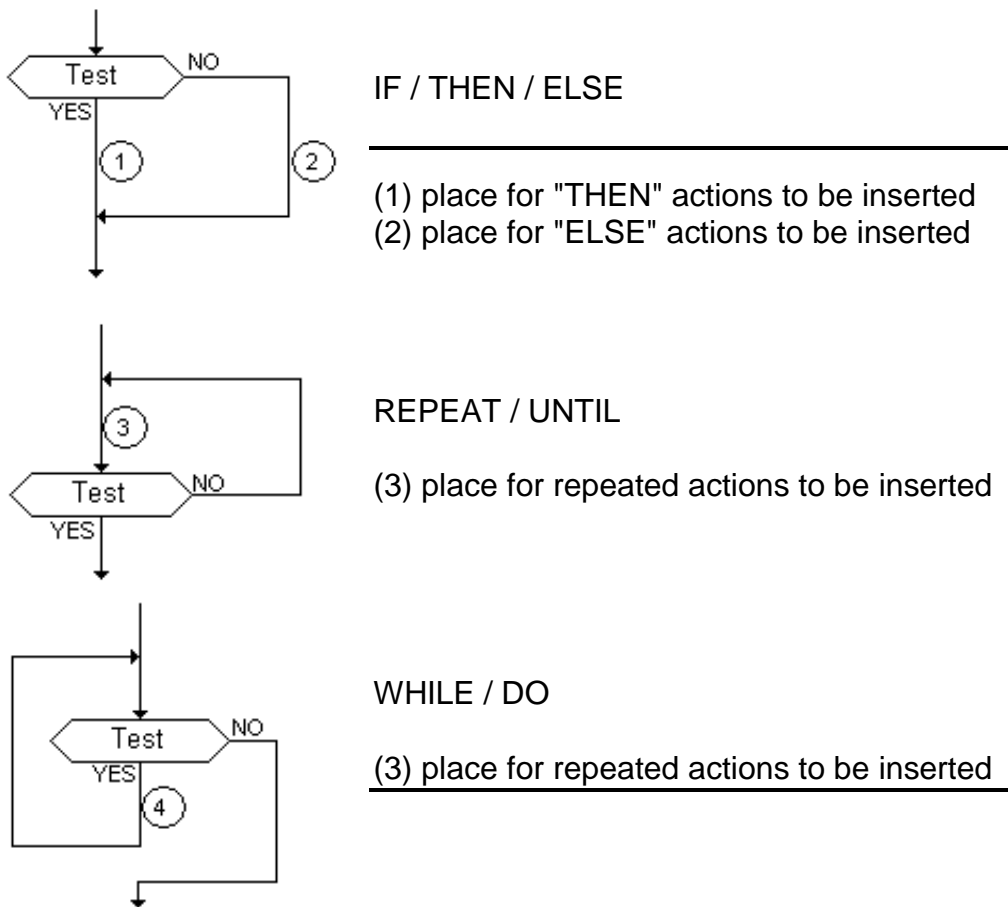

### E.4.3 FC dynamic behaviour

The **execution** of a Flow Chart diagram can be explained as follows:

- The Begin symbol takes one target cycle
- The End symbol takes one target cycle and ends the execution of the chart. After this symbol is reached, no more actions of the chart are executed.

- The flow is broken each time an item (action, decision) is encountered that has already been reached in the same cycle. In such a case the flow will continue on the next cycle.

Note: Contrary to SFC, an action is not a stable state. There is no repetition of instructions while the action symbol is highlighted.

#### **E.4.4 FC checking**

Apart of attached ST, LD or IL programming, some other **syntactic rules** apply to flow chart itself. Below is the list of main rules:

- All "connection" points of all symbols must be wired. (connection to "End" symbol may be omitted)
- All symbols must be linked together (no isolated part should appear)
- All connectors should have valid destination

Other minor syntax errors can be reported:

- Empty actions (no programming) are considered as steps during run time scheduling
- Empty tests (no programming) are considered as "always true"

## E.5 FBD language

---

The **Functional Block Diagram** (FBD) is a graphic language. It allows the programmer to build complex procedures by taking existing **functions** from the ISaGRAF library and **wiring** them together in the graphic diagram area.

### E.5.1 FBD diagram main format

FBD diagram describes a function between **input variables** and **output variables**. A function is described as a set of **elementary function blocks**. Input and output variables are connected to blocks by **connection lines**. An output of a function block may also be connected to an input of another block.

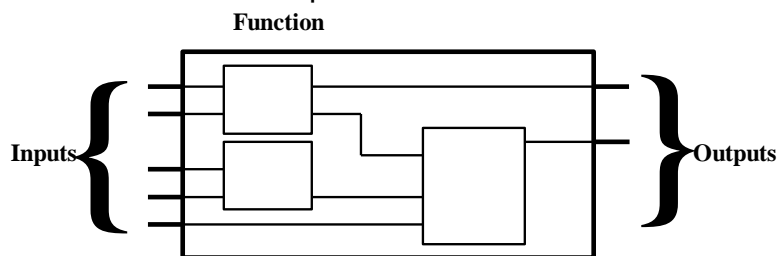

An entire function operated by an FBD program is built with standard **elementary** function blocks from the ISaGRAF library. Each function block has a fixed number of **input connection points** and a fixed number of **output connection points**. A function block is represented by a single **rectangle**. The inputs are connected on its **left border**. The outputs are connected on its **right border**. An elementary function block performs a single **function** between its inputs and its outputs. The name of the function to be performed by the block is written in its rectangle symbol. Each input or output of a block has a well-defined **type**.

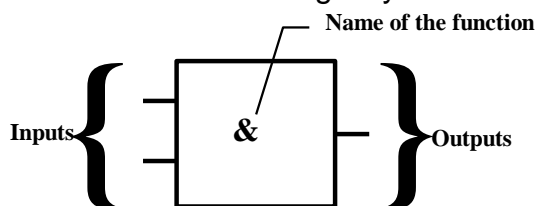

Input variables of an FBD program must be connected to input connection points of function blocks. The type of each variable must be the same as the type expected for the associated input. An input for FBD diagram can be a **constant** expression, any **internal** or **input** variable, or an **output** variable.

Output variables of an FBD program must be connected to output connection points of function blocks. The type of each variable must be the same as the type expected for the associated block output. An Output for FBD diagram can be any **internal** or **output** variable, or the name of the program (for **sub-programs** only). When an output is the name of the currently edited sub-program, it represents the assignment of the return value for the sub-program (returned to the calling program).

Input and output variables, inputs and outputs of the function blocks are wired together with **connection lines**. Single lines may be used to **connect** two logical points of the diagram:

- An input variable and an input of a function block
- An output of a function block and an input of another block
- An output of a function block and an output variable

The connection is **oriented**, meaning that the line carries associated data from the left extremity to the right extremity. The left and right extremities of the connection line must be of the **same type**.

Multiple right connection can be used to broadcast an information from its left extremity to each of its right extremities. All the extremities of the connection must be of the same type.

### E.5.2 RETURN statement

The "<RETURN>" keyword may occur as a diagram output. It must be connected to a boolean output connection point of a function block. The RETURN statement represents a **conditional end** of the program: if the output of the box connected to the statement has the boolean value **TRUE**, the end (remaining part) of the diagram is not executed.

(\* Example of an FBD program using RETURN statement \*)

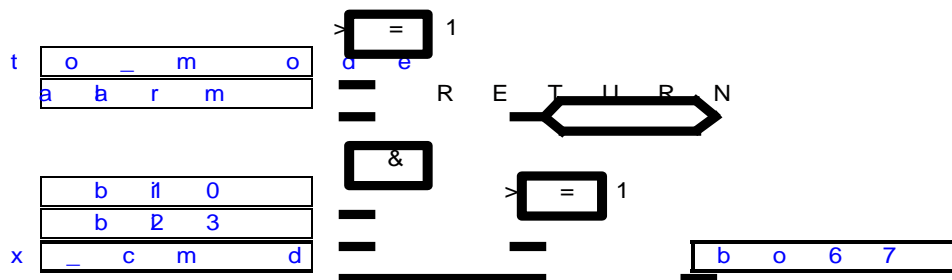

(\* ST equivalence: \*)

```
If auto_mode OR alarm Then
  Return;
End_if;
bo67 := (bi10 AND bi23) OR x_cmd;
```

### E.5.3 Jumps and labels

Labels and jumps are used to control the execution of the diagram. No other object may be connected on the right of a jump or label symbol. The following notations are used:

- >>LAB      jump to a label (label name is "LAB")
- LAB:        definition of a label (label name is "LAB")

If the connection line on the **left** of the jump symbol has the boolean state **TRUE**, the execution of the program directly jumps after the corresponding label symbol.

(\* Example of an FBD program using labels and jumps \*)

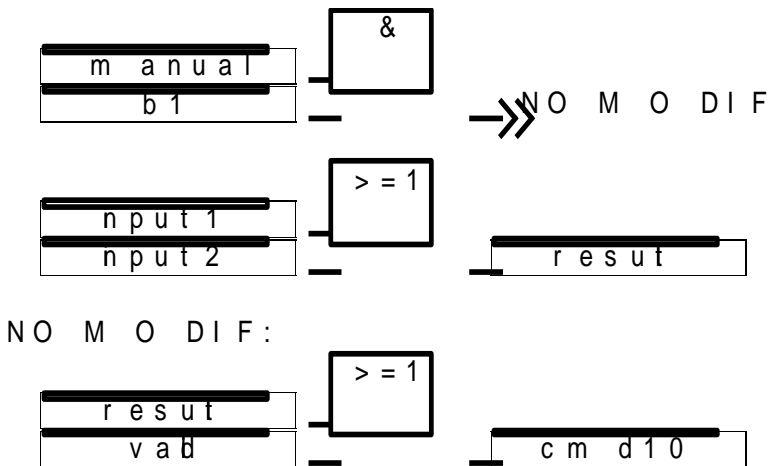

(\* IL Equivalence: \*)

```

ld    manual
and   b1
jmpc  NOMODIF
ld    input1
or    input2
st    result
NOMODIF: ld result
or    valid
st    cmd10

```

### E.5.4 Boolean negation

A single connection line with its right extremity connected to an input of a function block can be terminated by a **boolean negation**. The negation is represented by a small circle. When a boolean negation is used, the left and right extremities of the connection line must have the **BOOLEAN** type.

(\* Example of an FBD program using a boolean negation \*)

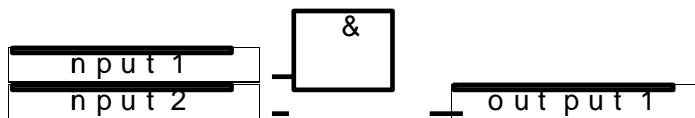

(\* ST equivalence: \*)

```
output1 := input1 AND NOT (input2);
```

### E.5.5 Calling function or function blocks from the FBD

The FBD language enables the calling of sub-programs, functions or function blocks. A sub-program, or function or function block is represented by a function box. The names written in the boxes are the name of the sub-program or function or function blocks.

In case of a sub-program or a function, the return value is the only output of the function box.  
 A function block can have more than one output.

(\* Example of an FBD program using SUB PROGRAM block \*)

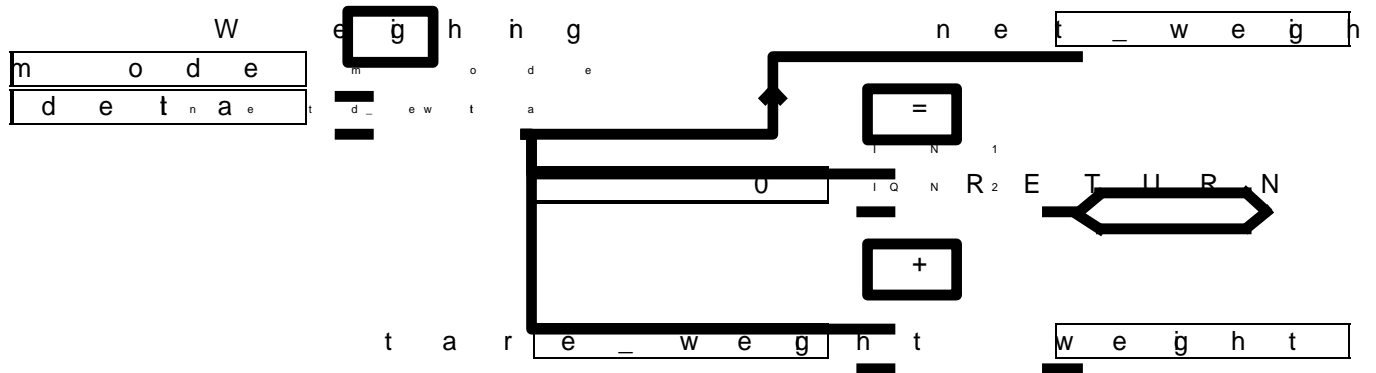

(\* ST Equivalence \*)

```
net_weight := Weighing (mode, delta); (* call sub-program *)
If (net_weight = 0) Then Return; End_if;
weight := net_weight + tare_weight;
```



## E.6 LD language

Ladder Diagram (LD) is a graphic representation of boolean equations, combining **contacts** (input arguments) with **coils** (output results). The LD language enables the description of tests and modifications of **boolean** data by placing **graphic symbols** into the program chart. LD graphic symbols are organized within the chart exactly as an electric contact diagram. LD diagrams are connected on the left side and on the right side to vertical **power rails**. These are basic graphic components of an LD diagram:

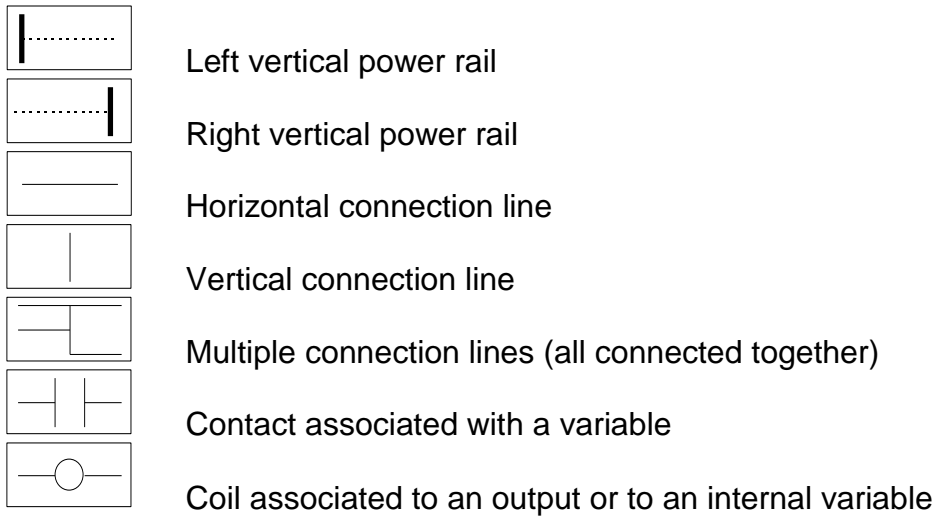

### E.6.1 Power rails and connection lines

An LD diagram is limited on the left and right side by vertical lines, named **left power rail** and **right power rail** respectively.

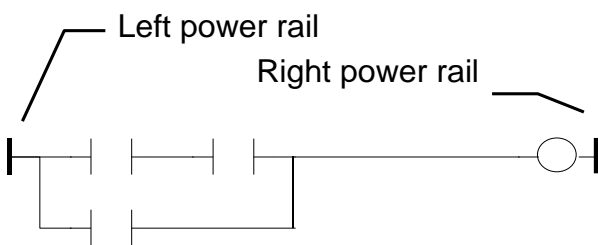

LD diagram graphic symbols are connected to power rails or to other symbols by **connection lines**. Connection lines are horizontal or vertical.

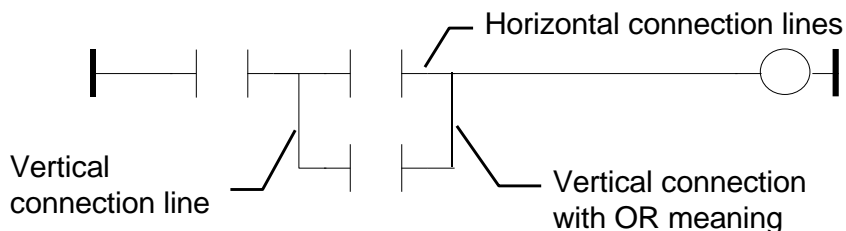

Each line segment has a boolean state **FALSE** or **TRUE**. The boolean state is the same for all the segments directly linked together. Any horizontal line connected to the left **vertical power rail** has the **TRUE** state.

## E.6.2 Multiple connection

The boolean state given to a single horizontal connection line is the same on the left and on the right extremities of the line. Combining horizontal and vertical connection lines enables the building of **multiple connections**. The boolean state of the extremities of a multiple connection follows logic rules.

A **multiple connection on the left** combines **more than one** horizontal lines connected on the **left** side of a vertical line, and **one** line connected on its **right** side. The boolean state of the right extremity is the **LOGICAL OR** between all the left extremities.

(\* Example of multiple LEFT connection \*)

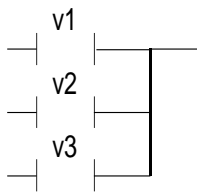

(\* right extremity state is (v1 OR v2 OR v3) \*)

A **multiple connection on the right** combines **one** horizontal line connected on the **left** side of a vertical line, and **more than one** line connected on its **right** side. The boolean state of the left extremity is propagated into each of the right extremities.

(\* Example of multiple RIGHT connection \*)

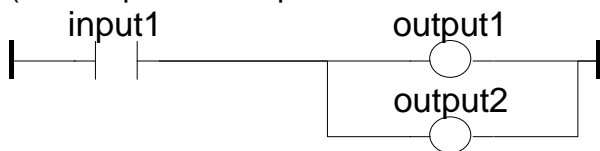

(\* ST equivalence: \*)

output1 := input1;

output2 := input1;

A **multiple connection on the left and on the right** combines **more than one** horizontal line connected on the **left** side of a vertical line, and **more than one** line connected on its **right** side. The boolean state of each of the right extremities is the **LOGICAL OR** between all the left extremities

(\* Example of multiple LEFT and RIGHT connection \*)

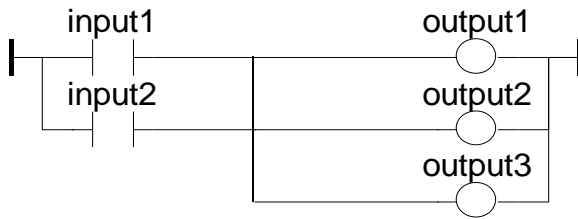

(\* ST Equivalence: \*)

output1 := input1 OR input2;

output2 := input1 OR input2;

output3 := input1 OR input2;

### E.6.3 Basic LD contacts and coils

There are several symbols available for input contacts:

- Direct contact
- Inverted contact
- Contacts with edge detection

There are several symbols available for output coils:

- Direct coil
- Inverted coil
- SET coil
- RESET coil
- Coils with edge detection

The name of the variable is written above any of these graphic symbols:

⇒ **Direct contact**

A direct contact enables a **boolean operation** between a **connection line** state and a boolean **variable**.

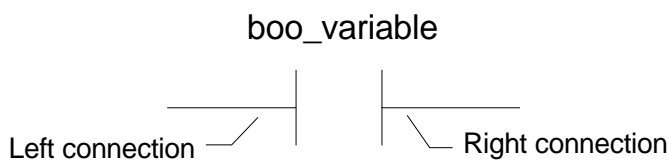

The state of the connection line on the right of the contact is the **LOGICAL AND** between the state of the left connection line and the value of the variable associated with the contact.

(\* Example using DIRECT contacts \*)

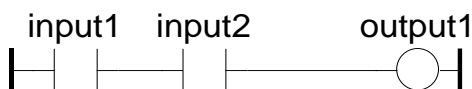

(\* ST Equivalence: \*)

output1 := input1 AND input2;

⇒ **Inverted contact**

An inverted contact enables a **boolean operation** between a **connection line** state and the boolean negation of a boolean **variable**.

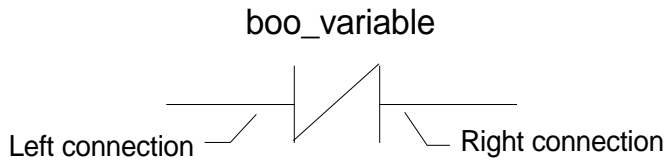

The state of the connection line on the right of the contact is the **LOGICAL AND** between the state of the left connection line and the **boolean negation** of the value of the variable associated with the contact.

(\* Example using INVERTED contacts \*)

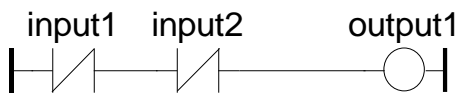

(\* ST Equivalence: \*)  
`output1 := NOT (input1) AND NOT (input2);`

▬ **Contact with rising edge detection**

This contact (positive) enables a **boolean operation** between a **connection line** state and the rising edge of a boolean **variable**.

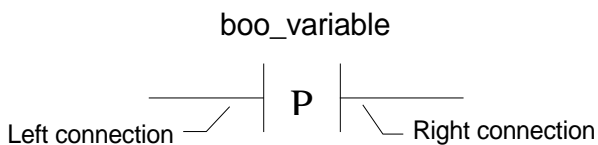

The state of the connection line on the right of the contact is set to **TRUE** when the state of the connection line on the left is **TRUE**, and the state of the associated variable **rises** from FALSE to TRUE. It is reset to FALSE in all other cases.

(\* Example using RISING EDGE contacts \*)

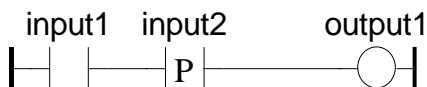

(\* ST Equivalence: \*)  
`output1 := input1 AND (input2 AND NOT (input2prev));`  
 (\* input2prev is the value of input2 at the previous cycle \*)

▬ **Contact with falling edge detection**

This contact (negative) enables a **boolean operation** between a **connection line** state and the falling edge of a boolean **variable**.

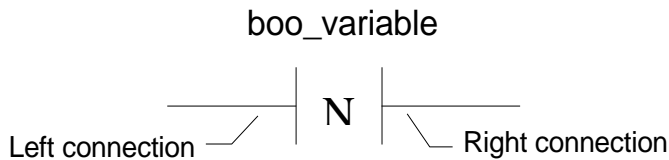

The state of the connection line on the right of the contact is set to **TRUE** when the state of the connection line on the left is **TRUE**, and the state of the associated variable **falls** from TRUE to FALSE. It is reset to FALSE in all other cases.

(\* Example using FALLING EDGE contacts \*)

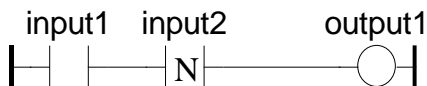

(\* ST Equivalence: \*)

output1 := input1 AND (NOT (input2) AND input2prev);

(\* input2prev is the value of input2 at the previous cycle \*)

= **Direct coil**

Direct coils enable a **boolean output** of a **connection line** boolean state.

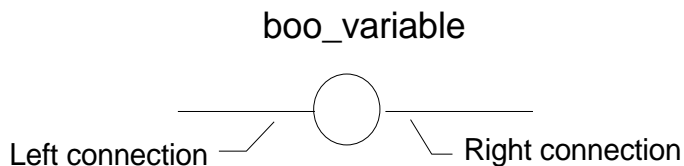

The associated variable is assigned with the boolean **state of the left connection**. The state of the left connection is propagated into the right connection. The right connection may be connected to the right vertical power rail.

The associated boolean variable must be **OUTPUT** or **INTERNAL**.

The associated name can be the name of the program (for **sub-programs** only). This corresponds to the assignment of the return value of the sub-program.

(\* Example using DIRECT coils \*)

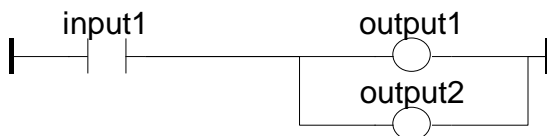

(\* ST Equivalence: \*)

output1 := input1;

output2 := input1;

= **Inverted coil**

Inverted coils enable a **boolean output** according to the boolean **negation** of a **connection line** state.

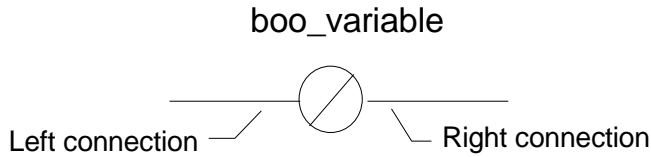

The associated variable is assigned with the boolean **negation** of the **state of the left connection**. The state of the left connection is propagated into the right connection. Right connection may be connected to the right vertical power rail.

The associated boolean variable must be **OUTPUT** or **INTERNAL**.  
 The associated name can be the name of the program (for **sub-programs** only). This corresponds to the assignment of the return value of the sub-program.

(\* Example using INVERTED coils \*)

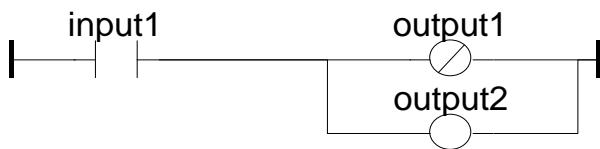

(\* ST Equivalence: \*)  
 output1 := NOT (input1);  
 output2 := input1;

= **SET coil**

"Set" coils enable a **boolean output** of a **connection line** boolean state.

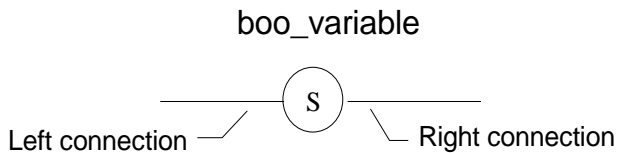

The associated variable is **SET TO TRUE** when the boolean **state of the left connection** becomes TRUE. The output variable keeps this value until an inverse order is made by a "RESET" coil. The state of the left connection is propagated into the right connection. Right connection may be connected to the right vertical power rail.

The associated boolean variable must be **OUTPUT** or **INTERNAL**.

(\* Example using "SET" and "RESET" coils \*)

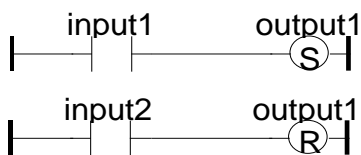

(\* ST Equivalence: \*)

```

IF input1 THEN
  output1 := TRUE;
END_IF;
IF input2 THEN
  output1 := FALSE;
END_IF;

```

▬ **RESET coil**

"Reset" coils enable **boolean output** of a **connection line** boolean state.

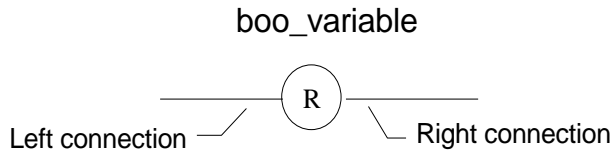

The associated variable is **RESET TO FALSE** when the boolean **state of the left connection** becomes **TRUE**. The output variable keeps this value until an inverse order is made by a "SET" coil. The state of the left connection is propagated into the right connection. Right connection may be connected to the right vertical power rail.

The associated boolean variable must be **OUTPUT** or **INTERNAL**.

(\* Example using "SET" and "RESET" coils \*)

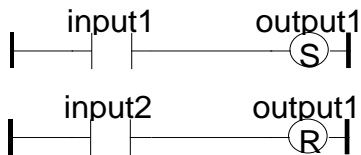

(\* ST Equivalence: \*)

```

IF input1 THEN
  output1 := TRUE;
END_IF;
IF input2 THEN
  output1 := FALSE;
END_IF;

```

▬ **Coil with rising edge detection**

"Positive" coils enable **boolean output** of a **connection line** boolean state. This type of coils is only available using the Quick ladder editor.

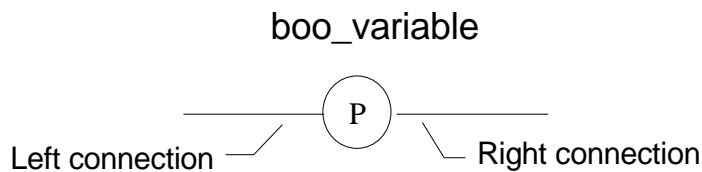

The associated variable is set to **TRUE** when the boolean **state of the left connection** rises from FALSE to TRUE. The output variable resets to FALSE in all other cases. The state of the left connection is propagated into the right connection. Right connection may be connected to the right vertical power rail.

The associated boolean variable must be **OUTPUT** or **INTERNAL**.

(\* Example using a "Positive" coil \*)



(\* ST Equivalence: \*)

```
IF (input1 and NOT(input1prev)) THEN
  output1 := TRUE;
ELSE
  output1 := FALSE;
END_IF;
```

(\* input1prev is the value of input1 at the previous cycle \*)

= **Coil with falling edge detection**

"Negative" coils enable **boolean output** of a **connection line** boolean state. This type of coils is only available using the Quick ladder editor.

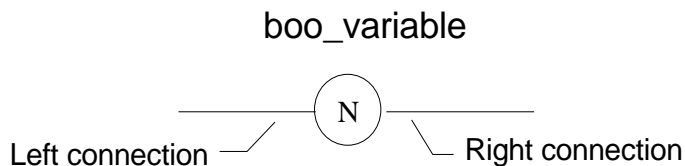

The associated variable is set to **TRUE** when the boolean **state of the left connection** falls from TRUE to FALSE. The output variable resets to FALSE in all other cases. The state of the left connection is propagated into the right connection. Right connection may be connected to the right vertical power rail.

The associated boolean variable must be **OUTPUT** or **INTERNAL**.

(\* Example using a "Positive" coil \*)

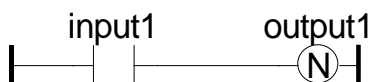

(\* ST Equivalence: \*)

```
IF (NOT(input1) and input1prev) THEN
  output1 := TRUE;
ELSE
  output1 := FALSE;
END_IF;
```

(\* input1prev is the value of input1 at the previous cycle \*)



## E.6.4 RETURN statement

The **RETURN** label can be used as an output to represent a conditional end of the program. No connection can be put on the right of a RETURN symbol.



If the **left connection** line has the **TRUE** boolean state, the program ends without executing the equations entered on the following lines of the diagram.

Note: When the LD program is a sub-program, its name has to be associated with an output coil to set the return value (returned to the calling program).

(\* Example using RETURN symbol \*)

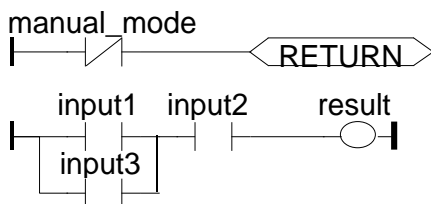

(\* ST Equivalence: \*)

```
If Not (manual_mode) Then RETURN; End_if;  
result := (input1 OR input3) AND input2;
```

## E.6.5 Jumps and labels

Labels, conditional and unconditional JUMPS symbols, can be used to control the execution of the diagram. No connection can be put on the right of the label and jump symbol. The following notations are used:

**>>LAB**      jump to label named "LAB"  
**LAB:**        definition of the label named "LAB"

If the **connection on the left** of the jump symbol has the **TRUE** boolean state, the program execution is driven after the label symbol.

(\* Example using JUMP and LABEL symbols \*)

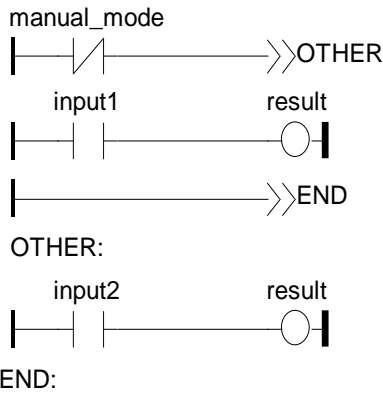

(\* IL Equivalence: \*)

```

ldn    manual_mode
jmpc   other
ld     input1
st     result
jmp    END
OTHER: ld input2
st     result
END:   (* end of program *)

```

## E.6.6 Blocks in LD

Using the Quick LD editor, you connect function boxes to boolean lines. A function can actually be an operator, a function block or a function. As all blocks do not have always a boolean input and/or a boolean output, inserting blocks in an LD diagram leads to the addition of new parameters EN, ENO to the block interface. The EN, ENO parameters are not added if you use the FBD/LD editor as you can connect the variable with the required type.

### = The "EN" input

On some operators, functions or function blocks, the first input does not have boolean data type. As the first input must always be connected to the rung, another input is automatically inserted at the first position, called "EN". The block is executed only if the **EN** input is TRUE. Below is the example of a comparison operator, and the equivalent code expressed in ST:

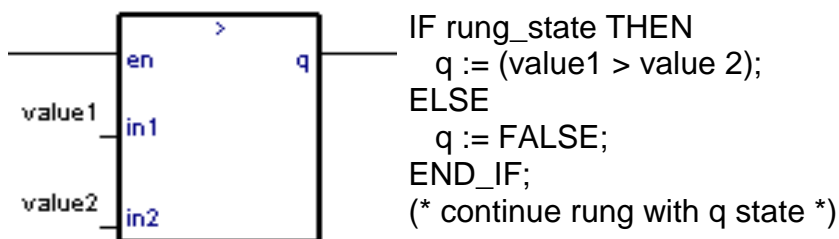

### = The "ENO" output

On some operators, functions or function blocks, the first output does not have boolean data type. As the first output must always be connected to the rung, another output is automatically inserted at the first position, called "ENO". The **ENO** output always takes the

same state as the first input of the block. Below is an example with AVERAGE function block, and the equivalent code expressed in ST:

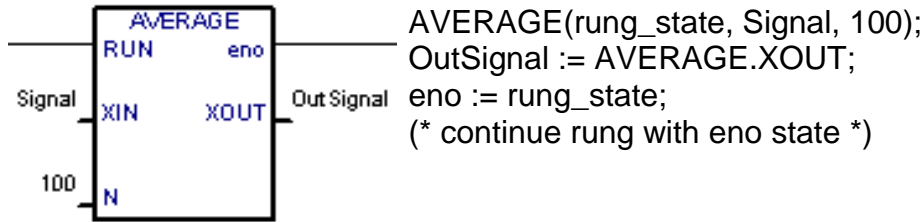

```

AVERAGE(rung_state, Signal, 100);
OutSignal := AVERAGE.XOUT;
eno := rung_state;
(* continue rung with eno state *)
  
```

▬ *The "EN" and "ENO" parameters*

On some cases, both **EN** and **ENO** are required. Below is an example with an arithmetic operator, and the equivalent code expressed in ST:

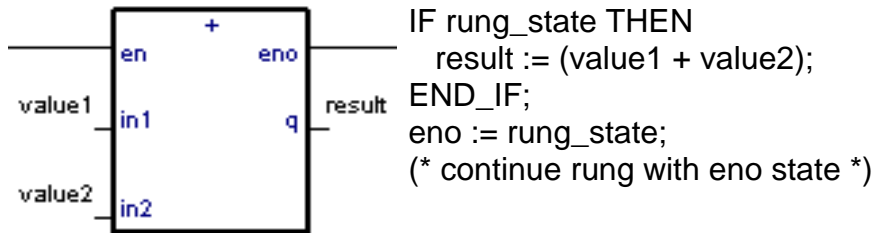

```

IF rung_state THEN
  result := (value1 + value2);
END_IF;
eno := rung_state;
(* continue rung with eno state *)
  
```

## E.7 ST language

---

ST (**Structured Text**) is a high level structured language designed for automation processes. This language is mainly used to implement complex procedures that cannot be easily expressed with graphic languages. ST is the default language for the description of the actions within the steps and conditions attached to the transitions of the **SFC** language.

### E.7.1 ST main syntax

An ST program is a list of ST **statements**. Each statement ends with a semi-colon (";") separator. Names used in the source code (variable identifiers, constants, language keywords...) are separated with **inactive separators** (space character, end of line or tab stops) or by **active separators**, which have a well defined significance (for example, the ">" separator indicates a "greater than" comparison. Comments may be freely inserted into the text. A comment must begin with "(" and ends with ")". Each statement terminates with a semi-colon (";") separator. These are basic types of ST statements:

- **assignment** statement (variable := expression;)
- sub-program or function call
- function block call
- **selection** statements (IF, THEN, ELSE, CASE...)
- **iteration** statements (FOR, WHILE, REPEAT...)
- **control** statements (RETURN, EXIT...)
- special statements for links with other languages such as **SFC**

Inactive separators may be freely entered between active separators, constant expressions and identifiers. ST inactive separators are: **Space** (blank) character, **Tabs** and **End of line** character. Unlike line-formatted languages such as IL, end of lines may be entered anywhere in the program. The rules shown below should be followed when using inactive separators to increase ST program readability:

- Do not write more than one statement on one line
- Use tabs to indent complex statements
- Insert comments to increase readability of lines or paragraphs

### E.7.2 Expression and parentheses

ST expressions combine ST **operators** and variable or constant **operands**. For each single expression (combining operands with one ST operator), the **type** of the operands must be the same. This single expression has the same type as its operands, and can be used in a more complex expression. For example :

(boo_var1 AND boo_var2)	has BOO type
not (boo_var1)	has BOO type
(sin (3.14) + 0.72)	has REAL ANALOG type
(t#1s23 + 1.78)	is an invalid expression

**Parentheses** are used to isolate sub parts of the expression, and to explicitly order the priority of the operations. When no parentheses are given for a complex expression, the operation sequence is implicitly given by the default **priority** between ST operators. For example:

2 + 3 \* 6 equals 2+18=20 because multiplication operator has a higher priority

(2+3) \* 6 equals 5\*6=30 priority is given by parenthesis

Warning: A maximum number of **8** levels of parentheses can be nested within an expression.

### E.7.3 Function or function block calls

Standard ST function calls may be used for each of following objects:

- Sub-programs
- Library functions and function blocks written in IEC languages
- "C" functions and function blocks
- Type conversion functions

#### = **Calling sub-programs or functions**

**Name:** name of the called sub-program  
or library function written in IEC language or in "C"

**Meaning:** calls a ST, IL, LD or FBD sub-program or function or a "C" function and gets its return value

**Syntax:** <variable> := <subprog> (<par1>, ... <parN> );

**Operands:** The type of return value and calling parameters must follow the interface defined for the sub-program.

**Return value:** value returned by the sub-program

Sub-program calls may be used in any expression. They also may be used in an SFC transition.

Example1: Sub-program call

```
(* Main ST program *)
(* gets an analog value and converts it into a limited time value *)
ana_timeprog := SPLimit ( tprog_cmd );
appl_timer := tmr (ana_timeprog * 100);
```

(\* Called FBD program named 'SPLimit' \*)

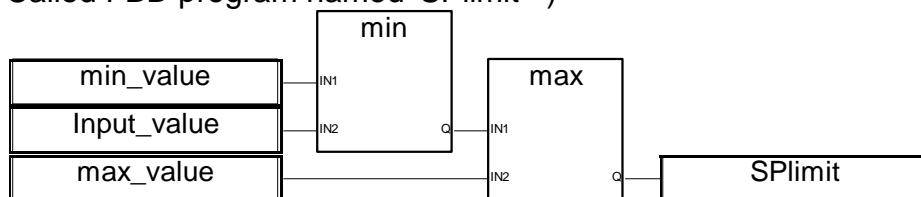

Example2: Function call

(\* functions used in complex expressions: min, max, right, mlen and left are standard "C" functions \*)

```
limited_value := min (16, max (0, input_value) );  
rol_msg := right (message, mlen (message) - 1) + left (message, 1);
```

#### = **Calling function blocks**

**Name:** name of the function block instance  
**Meaning:** calls a function block from the ISaGRAF library or from the user's library and accesses its return parameters  
**Syntax:** (\* call of the function block \*)  
<blockname> ( <p1>, <p2> ... );  
(gets its return parameters \*)  
<result> := <blockname>. <ret\_param1>;  
...  
<result> := <blockname>. <ret\_paramN>;  
**Operands:** parameters are expressions which match the type of the parameters specified for that function block  
**Return value:** See Syntax to get the return parameters.

Consult the ISaGRAF library to find the meaning and type of each function block parameter.  
The function block instance (name of the copy) must be declared in the dictionary

Example :

```
(* ST program calling a function block *)  
  
(* declare the instance of the block in the dictionary: *)  
(* trigb1 : block R_TRIG - rising edge detection *)  
  
(* function block activation from ST language *)  
trigb1 (b1);  
(* return parameters access *)  
If (trigb1.Q) Then nb_edge := nb_edge + 1; End_if;
```

### **E.7.4 ST specific boolean operators**

The following boolean operators are specific to the ST language:

- REDGE rising edge detection
- FEDGE falling edge detection

Other standard boolean operators such as:

- NOT boolean negation
- AND (&) logical AND
- OR logical OR
- XOR logical exclusive OR

can be used. Their description is to be found in the section 'Standard operators, function blocks and functions'.

#### = **"REDGE" operator**

**Name:** REDGE  
**Meaning:** evaluates the rising edge of a complete boolean expression

**Syntax:** <edge> := REDGE ( <boo\_expression>, <memo\_variable> );  
**Operands:** first operand is any boolean variable or complex expression  
second operand is an internal boolean variable used to store the last state of the expression  
**Return value:** TRUE when the expression changes from FALSE to TRUE  
FALSE for all other cases

The rising edge of an expression cannot be detected more than once in the same execution cycle, using the REDGE operator. This operator can be used to describe the condition attached to an SFC transition.

Warning: The "memory" boolean variable used to store the last state of the expression cannot be used as a trigger for edges of different expressions.

When the expression is a boolean variable named "xxx", a unique internal variable named "EDGE\_xxx" should be declared and used in the REDGE expressions for this variable. This method ensures that the memory variable is not overwritten during other REDGE evaluations.

Example:

(\* ST program using REDGE operator \*)

(\* this program counts the rising edges of a boolean input \*)

(\* Bi120 is an input boolean variable \*)

(\* Edge\_Bi120 is the memory of the Bi120 variable state \*)

```
If REDGE (Bi120, Edge_Bi120) Then
    Counter := Counter + 1;
End_if;
```

Note: this operator is not in the IEC1131-3 norm. You may prefer the use of R\_TRIG standard block. It has been kept for compatibility reasons.

### = **"FEDGE" operator**

**Name:** FEDGE  
**Meaning:** evaluates the falling edge of a boolean expression  
**Syntax:** <edge> := FEDGE ( <boo\_expression>, <memo\_variable> );  
**Operands:** first operand is any boolean variable or complex expression  
second operand is an internal boolean variable used to store the last state of the expression  
**Return value:** TRUE when the expression changes from TRUE to FALSE  
FALSE for all other cases

The falling edge of an expression cannot be detected more than once in the same execution cycle, using the REDGE operator. The operator can be used to describe the condition attached to an SFC transition.

Warning: The "memory" boolean variable used to store the last state of the expression cannot be used as a trigger for edges of different expressions.

When the expression is a boolean variable named "**xxx**", a unique internal variable named "**EDGE\_xxx**" should be declared and used it in the FEDGE expressions for this variable. This method ensures that the memory variable is not overwritten during other FEDGE evaluations.

Example:

```
(* ST program using FEDGE operator *)
```

```
(* this program counts the falling edges of a boolean input *)  
(* Bi120 is an input boolean variable *)  
(* Edge_Bi120 is the memory of the Bi120 variable state *)
```

```
If FEDGE (Bi120, Edge_Bi120) Then  
    Counter := Counter + 1;  
End_if;
```

Note: this operator is not in the IEC1131-3 norm. You may prefer the use of F\_TRIG standard block. It has been kept for compatibility reasons.

## E.7.5 ST basic statements

The basic statements of the ST language are:

- Assignment
- RETURN statement
- IF-THEN-ELSIF-ELSE structure
- CASE statement
- WHILE iteration statement
- REPEAT iteration statement
- FOR iteration statement
- EXIT statement

### = **Assignment**

Name: :=

**Meaning:** assigns a variable to an expression

**Syntax:** <variable> := <any\_expression> ;

**Operands:** variable must be internal or output  
variable and expression must have the same type

The expression can be a call to a sub-program or a function from the ISaGRAF library

Example:

```
(* ST program with assignments *)
```



```
(* variable <=< variable *)
bo23 := bo10;
```

```
(* variable <=< expression *)
bo56 := bx34 OR alm100 & (level >= over_value);
result := (100 * input_value) / scale;
```

```
(* assignment with sub-program return value *)
rc := PSelect ( );
```

```
(* assignment with function call *)
limited_value := min (16, max (0, input_value) );
```

= **RETURN statement**

Name: RETURN

**Meaning:** terminates the execution of the current program

Syntax: RETURN ;

Operands: (none)

In an SFC action block, the RETURN statement indicates the end of the execution of that block only.

Example:

(\* FBD specification of the program: programmable counter \*)

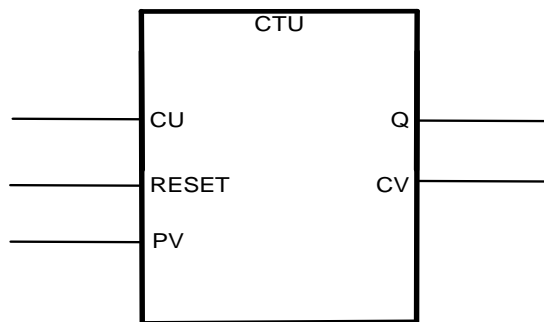

(\* ST implementation of the program, using RETURN statement \*)

```
If not (CU) then
    Q := false;
    CV := 0;
    RETURN; (* terminates the program *)
end_if;
```

```
if R then
    CV := 0;
else
    if (CV < PV) then
        CV := CV + 1;
```

```
end_if;  
end_if;  
Q := (CV >= PV);
```

= ***IF-THEN-ELSIF-ELSE statement***

Name: IF ... THEN ... ELSIF ... THEN ... ELSE ... END\_IF

**Meaning:** executes one of two lists of ST statements  
selection is made according to the value  
of a boolean expression

Syntax: IF <boolean\_expression> THEN  
    <statement> ;  
    <statement> ;  
    ...  
    ELSIF <boolean\_expression> THEN  
        <statement> ;  
        <statement> ;  
    ...  
    ELSE  
        <statement> ;  
        <statement> ;  
    ...  
END\_IF;

The ELSE and ELSIF statements are optional. If the ELSE statement is not written, no instruction is executed when the condition is FALSE.

Example:

(\* ST program using IF statement \*)

```
IF manual AND not (alarm) THEN  
    level := manual_level;  
    bx126 := bi12 OR bi45;  
ELSIF over_mode THEN  
    level := max_level;  
ELSE  
    level := (lv16 * 100) / scale;  
END_IF;
```

(\* IF structure without ELSE \*)

```
If overflow THEN  
alarm_level := true;  
END_IF;
```

### = **CASE statement**

Name: CASE ... OF ... ELSE ... END\_CASE

**Meaning:** executes one of several lists of ST statements  
selection is made according to an integer expression

Syntax: CASE <integer\_expression> OF  
    <value> : <statements> ;  
    <value> , <value> : <statements> ;  
    ...  
ELSE  
    <statements> ;  
END\_CASE;

Case values must be integer constant expressions. Several values, separated by comas, can lead to the same list of statements. The ELSE statement is optional.

Example:

(\* ST program using CASE statement \*)

```
CASE error_code OF
  255:   err_msg := 'Division by zero';
        fatal_error := TRUE;
  1:     err_msg := 'Overflow';
  2, 3:  err_msg := 'Bad sign';
ELSE
  err_msg := 'Unknown error';
END_CASE;
```

### = **WHILE statement**

Name: WHILE ... DO ... END\_WHILE

**Meaning:** iteration structure for a group of ST statements  
the "continue" condition is evaluated BEFORE any iteration

Syntax: WHILE <boolean\_expression> DO  
    <statement> ;  
    <statement> ;  
    ...  
END\_WHILE ;

Warning: Because ISaGRAF is a **synchronous** system, input variables are not refreshed during WHILE iterations. The change of state of an input variable cannot be used to describe the condition of a WHILE statement.

Example:

(\* ST program using WHILE statement \*)

(\* this program uses specific "C" functions to read characters \*)

(\* on a serial port \*)

```
string := ""; (* empty string *)  
nbchar := 0;
```

```
WHILE ((nbchar < 16) & ComIsReady ( )) DO  
    string := string + ComGetChar ( );  
    nbchar := nbchar + 1;  
END_WHILE;
```

#### = **REPEAT statement**

Name: REPEAT ... UNTIL ... END\_REPEAT

**Meaning:** iteration structure for a group of ST statements  
the "continue" condition is evaluated AFTER any iteration

Syntax: REPEAT  
    <statement> ;  
    <statement> ;  
    ...  
    UNTIL <boolean\_condition>  
END\_REPEAT ;

Warning: Because ISaGRAF is a **synchronous** system, input variables are not refreshed during REPEAT iterations. The change of state of an input variable cannot be used to describe the ending condition of a REPEAT statement.

Example:

(\* ST program using REPEAT statement \*)

(\* this program uses specific "C" functions to read characters \*)  
(\* on a serial port \*)

```
string := ""; (* empty string *)  
nbchar := 0;  
IF ComIsReady ( ) THEN  
    REPEAT  
        string := string + ComGetChar ( );  
        nbchar := nbchar + 1;  
    UNTIL ( nbchar >= 16) OR NOT (ComIsReady ( )) )  
    END_REPEAT;  
END_IF;
```

#### = **FOR statement**

Name: FOR ... TO ... BY ... DO ... END\_FOR

**Meaning:** executes a limited number of iterations,  
using an integer analog index variable

Syntax:     FOR <index> := <mini> TO <maxi> BY <step> DO  
              <statement> ;  
              <statement> ;  
              END\_FOR;

**Operands:** **index:**         internal analog variable increased at any loop  
              **mini:**         initial value for index (before first loop)  
              **maxi:**         maximum allowed value for index  
              **step:**         index increment at each loop

The [ BY step ] statement is optional. If not specified, the increment step is 1

Warning: Because ISaGRAF is a **synchronous** system, input variables are not refreshed during FOR iterations.

This is the "while" equivalent of a FOR statement:

```
index := mini;  
while (index <= maxi) do  
  <statement> ;  
  <statement> ;  
  index := index + step;  
end_while;
```

Example:

```
(* ST program using FOR statement *)  
(* this program extracts the digit characters of a string *)
```

```
length := mlen (message);  
target := ""; (* empty string *)  
FOR index := 1 TO length BY 1 DO  
  code := ascii (message, index);  
  IF (code >= 48) & (code <= 57) THEN  
    target := target + char (code);  
  END_IF;  
END_FOR;
```

#### ▬ **EXIT statement**

Name:       EXIT  
**Meaning:**  exit from a FOR, WHILE or REPEAT iteration statement  
Syntax:     EXIT;  
Operands:  (none)

The EXIT is commonly used within an IF statement, inside a FOR, WHILE or REPEAT block.

Example:

(\* ST program using EXIT statement \*)  
(\* this program searches for a character in a string \*)

```
length := mlen (message);  
found := NO;  
FOR index := 1 TO length BY 1 DO  
    code := ascii (message, index);  
    IF (code = searched_char) THEN  
        found := YES;  
        EXIT;  
    END_IF;  
END_FOR;
```

## E.7.6 ST extensions

The following functions are extensions of the ST language:

- TSTART - TSTOP: timer control

The following statements and functions are available to control the execution of the SFC child programs. They may be used inside ACTION(): ... END\_ACTION; blocks in SFC steps.

- GSTART starts an SFC program
- GKILL kills an SFC program
- GFREEZE freezes an SFC program
- GRST restarts a frozen SFC program
- GSTATUS gets current status of an SFC program

Warning: These functions are not in the IEC 1131-3 norm.

Easy equivalent can be found for GSTART and GKILL using the following syntax in the SFC step:

```
child_name(S); (* equivalent to GSTART(child_name); *)
child_name(R); (* equivalent to GKILL(child_name); *)
```

The following fields can be used to access the status of an SFC step:

**GSnnn.x** boolean value that represents the activity of the step

**GSnnn.t** time elapsed since the last activation of the step  
("nnn" is the reference number of the SFC step)

It is also possible to test the activity of a step declared in another SFC program, by using the following syntax:

**GSnnn(progname).x**

Warning: referencing a step of an other program, using this syntax is not in the IEC 1131-3 norm. An easy way to do the same respecting IEC rules, is to declare a global boolean variable in the dictionary which will represent the step activity to be tested (for example ref\_step\_X). Then you insert in the step, the variable with the N qualifier (ref\_step\_X(N);). Then in the program which wants to test the activity of the step, you use the variable.

Prog program the other program which needs step activity of Prog program.

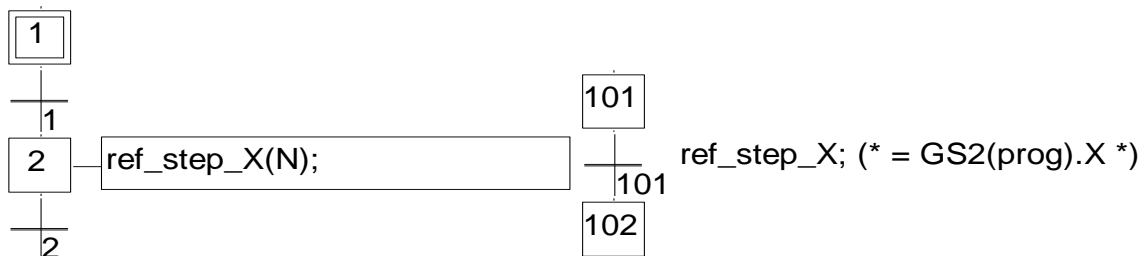

**TSTART statement**

Name: TSTART

Meaning: starts the counting of a timer variable  
timer value is not modified by the TSTART command, i.e. the counting starts from the current value of the timer.

Syntax: TSTART ( <timer\_variable> );

Operands: any inactive timer variable

Return value: (none)

Example:

(\* SFC program using TSTART and TSTOP statements \*)

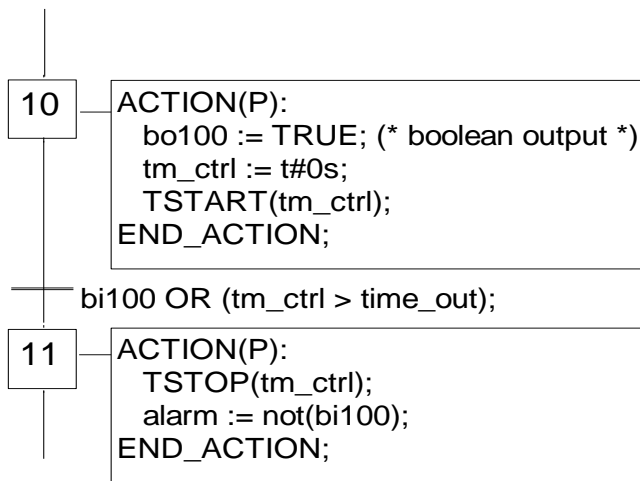

Time diagram if bi100 is always FALSE:

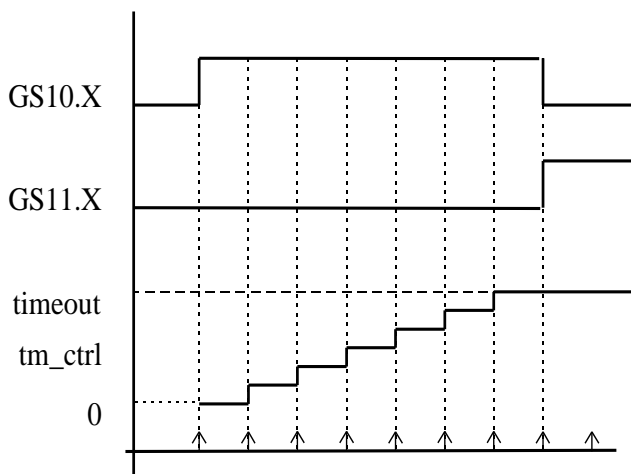

The timer keeps the same value during one cycle.



▬ **TSTOP statement**

Name: TSTOP

**Meaning:** stops updating a timer variable  
timer value is not modified by the TSTOP command

Syntax: TSTOP ( <timer\_variable> );

**Operands:** any active timer variable

Return value: (none)

Example: See TSTART (the function is described above)

▬ **GSTART statement**

Name: GSTART

**Meaning:** starts a child SFC program by putting a token into each of its initial steps

Syntax: GSTART ( <child\_program> );

**Operands:** the specified SFC program must be a child of the one in which the statement is written

Return value: (none)

Children of the child program are not automatically started by the GSTART statement.

Note: As GSTART is not in the IEC 1131-3 norm, prefer the use of the S qualifier, with the following syntax to start a child SFC:

Child\_name(S);

Example: Use of GSTART and GKILL

(\* Sequence 'Sfather' \*) (\* Sequence 'Schild' \*)

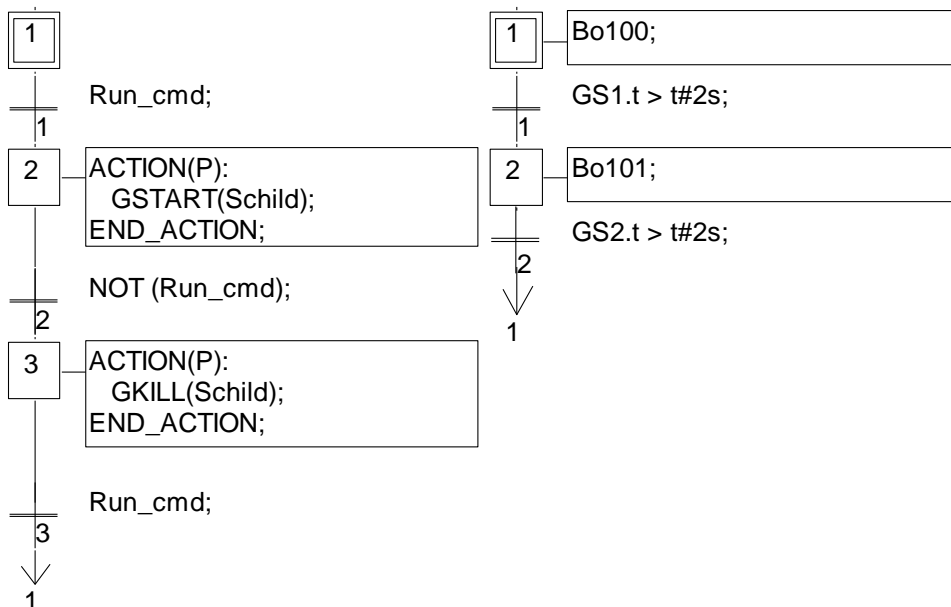

**= GKILL statement**

Name: GKILL

**Meaning:** kills a child SFC program by removing the tokens currently existing in its steps

Syntax: GKILL ( <child\_program> );

**Operands:** the specified SFC program must be a child of the one in which the statement is written

Return value: (none)

Children of the child program are automatically killed with the specified program.

**Note:** As GKILL is not in the IEC 1131-3 norm, prefer the use of the R qualifier, with the following syntax to kill a child SFC:

Child\_name(R);

Example: See GSTART (function described above)

**= GFREEZE statement**

Name: GFREEZE

**Meaning:** Suspends the execution of a child SFC program. Frozen program can be restarted by the GRST statement.

Syntax: GFREEZE ( <child\_program> );

**Operands:** the specified SFC program must be a child of the one in which the statement is written

Return value: (none)

Children of the child program are automatically frozen along with the specified program.

**Note:** GFREEZE is not in the IEC 1131-3 norm.

Example:

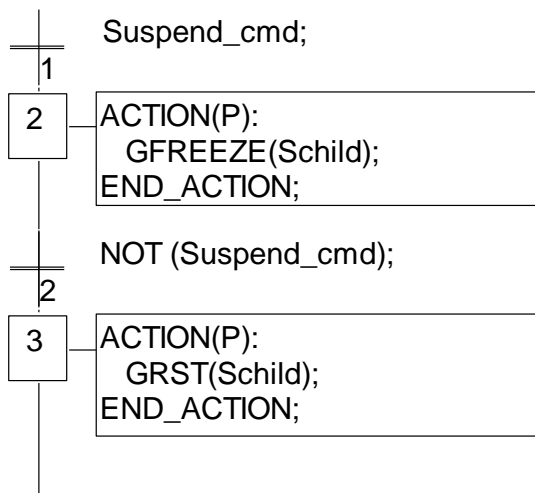

### = **GRST statement**

Name: GRST

**Meaning:** Restarts a child SFC program frozen by the GFREEZE statement.

Syntax: GRST ( <child\_program> );

**Operands:** the specified SFC program must be a child of the one in which the statement is written

Return value: (none)

Children of the child program are automatically restarted by the GRST statement

Note: GRST is not in the IEC 1131-3 norm.

Example: See GFREEZE (function described above)

### = **GSTATUS statement**

Name: GSTATUS

**Meaning:** returns the current status of an SFC program

Syntax: <ana\_var> := GSTATUS ( <child\_program> );

**Operands:** the specified SFC program must be a child of the one in which the statement is written

**Return value:** 0 = program is inactive (killed)

1 = program is active (started)

2 = program is frozen

Note: GSTATUS is not in the IEC 1131-3 norm.

Example:

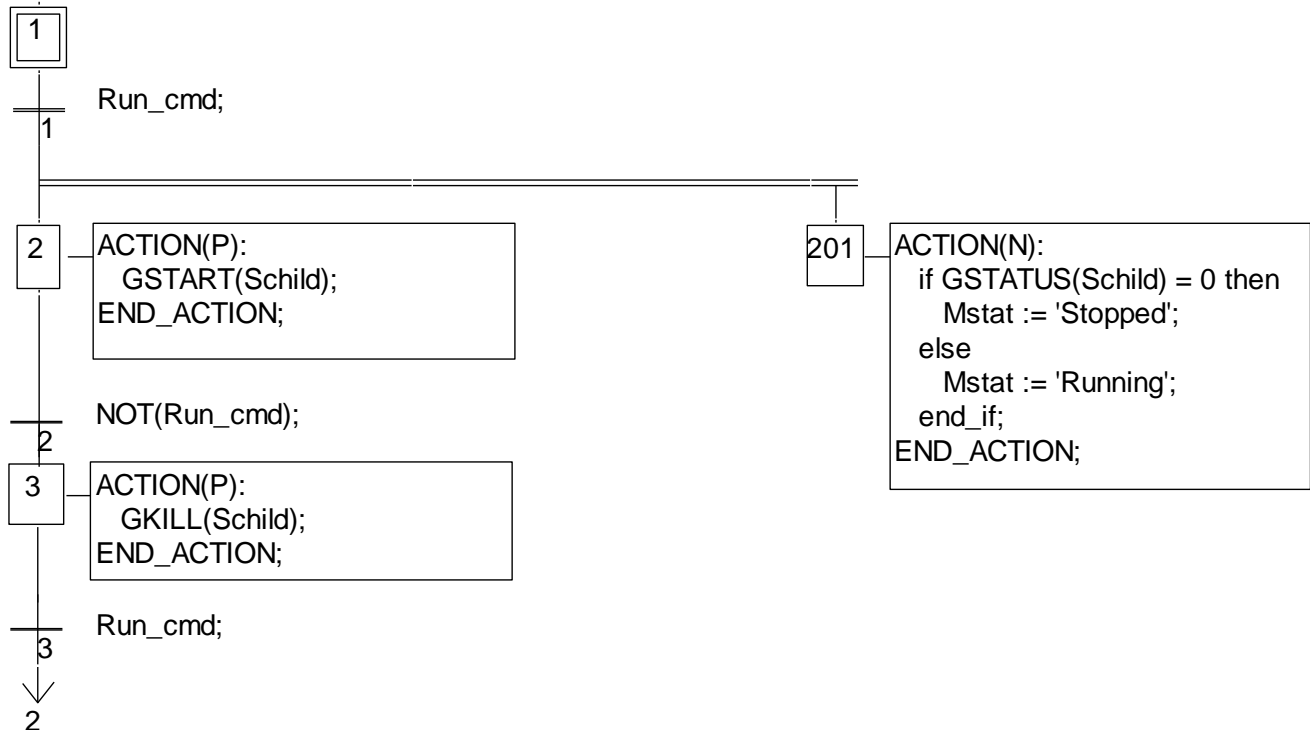

## E.8 IL language

---

**Instruction List**, or **IL** is a low level language. Instructions always relate to the **current result** (or **IL register**). The operator indicates the operation that must be made between the current value and the operand. The result of the operation is stored again in the current result.

### E.8.1 IL main syntax

An IL program is a list of **instructions**. Each instruction must begin on a new line, and must contain an **operator**, completed with optional **modifiers** and, if necessary, for the specific operation, one or more **operands**, separated with commas (','). A **label** followed by a colon (':') may precede the instruction. If a **comment** is attached to the instruction, it must be the last component of the line. Comments always begin with **'(\*** and ends with **\*)'**. Empty lines may be entered between instructions. Comments may be put on empty lines. Below are examples of instruction lines:

Label	Operator	Operand	Comments
Start:	LD	IX1	(* push button *)
	ANDN	MX5	(* command is not forbidden *)
	ST	QX2	(* start motor *)

#### = **Labels**

A **label** followed by a colon (':') may precede the instruction. A label can be put on an empty line. Labels are used as operands for some operations such as jumps. Naming labels must conform to the following rules:

- name cannot exceed **16** characters
- first character must be a **letter**
- following characters must be **letters**, **digits** or **'\_'** character

The same name cannot be used for more than one label in the same IL program. A label can have the same name as a variable.

#### = **Operator modifiers**

The available operator modifiers are shown below. The modifier character must complete the name of the operator, with no blank characters between them:

- N** boolean negation of the operand
- (** delayed operation
- C** conditional operation

The **'N'** modifier indicates a boolean negation of the operand. For example, the instruction **ORN IX12** is interpreted as: **result := result OR NOT (IX12)**.

The parenthesis **'(** modifier indicates that the evaluation of the instruction must be delayed until the closing parenthesis **)'** operator is encountered.

The '**C**' modifier indicates that the attached instruction must be executed only if the current result has the boolean value TRUE (different than 0 for non-boolean values). The '**C**' modifier can be combined with the '**N**' modifier to indicate that the instruction must be executed only if the current result has the boolean value FALSE (or 0 for non-boolean values).

= **Delayed operations**

Because there is only one IL register (current result), some operations may have to be delayed, so that the execution order or the instructions can be changed. Parentheses are used to indicate delayed operations:

'(' is a modifier indicates the operation to be delayed  
)' is an operator executes the delayed operation

The opening parenthesis '(' modifier indicates that the evaluation of the instruction must be delayed until the closing parenthesis ')' operator is encountered. For example, following sequence:

```
AND( IX12
OR  IX35
)
```

is interpreted as:

```
result := result AND ( IX12 OR IX35 )
```

### E.8.2 IL operators

The following table summarizes the standard operators of the IL language:

Operator	Modifiers	Operand	Description
LD	N	Variable, constant	Loads operand
ST	N	Variable	Stores current result
S		BOO variable	Sets to TRUE
R		BOO variable	Resets to FALSE
AND	N (	BOO	boolean AND
&	N (	BOO	boolean AND
OR	N (	BOO	boolean OR
XOR	N (	BOO	exclusive OR
ADD	(	variable, constant	Addition
SUB	(	variable, constant	Subtraction
MUL	(	variable, constant	Multiplication
DIV	(	variable, constant	Division

GT	(	variable, constant	Test: >
GE	(	variable, constant	Test: >=
EQ	(	variable, constant	Test: =
LE	(	variable, constant	Test <=
LT	(	variable, constant	Test <
NE	(	variable, constant	Test <>
CAL	C N	Function block	Calls a function block
JMP	C N	instance name	Jumps to label
RET	C N	Label	Returns from sub-program
)			Executes delayed operation

In the next section, only operators which are specific to the IL language are described, other standard operators can be found in the section "standard operators, function blocks and functions".

### = **LD operator**

**Operation** loads a value in the current result

Allowed modifiers N

**Operand** constant expression  
internal, input or output variable

Example:

(\* EXAMPLES OF LD OPERATIONS \*)

```
LDex:  LD    false      (* result := FALSE boolean constant *)
        LD    true       (* result := TRUE boolean constant *)
        LD    123        (* result := integer constant *)
        LD    123.1      (* result := real constant *)
        LD    t#3ms      (* result := time constant *)
        LD    boo_var1   (* result := boolean variable *)
        LD    ana_var1   (* result := analog variable *)
        LD    tmr_var1   (* result := timer variable *)
        LDN   boo_var2   (* result := NOT ( boolean variable ) *)
```

### = **ST operator**

**Operation** stores the current result in a variable  
the current result is not modified by this operation

Allowed modifiers N

**Operand** internal or output variable

Example:

(\* EXAMPLES OF ST OPERATIONS \*)

```
STboo:  LD    false
        ST    boo_var1   (* boo_var1 := FALSE *)
        STN   boo_var2   (* boo_var2 := TRUE *)
STana:  LD    123
```

```

      ST      ana_var1      (* ana_var1 := 123 *)
STtmr: LD      t#12s
      ST      tmr_var1     (* tmr_var1 := t#12s *)

```

= **S operator**

**Operation:** stores the boolean value TRUE in a boolean variable, if the current result has the boolean value TRUE. No operation is processed if current result is FALSE. The current result is not modified by this operation

Allowed modifiers: (none)

**Operand:** output or internal boolean variable

Example:

```

(* EXAMPLES OF S OPERATIONS *)
SETex: LD      true        (* current result := TRUE *)
      S      boo_var1     (* boo_var1 := TRUE *)
                          (* current result is not modified *)
      LD      false       (* current result := FALSE *)
      S      boo_var1     (* nothing done - boo_var1 unchanged *)

```

= **R operator**

**Operation** stores the boolean value FALSE in a boolean variable, if the current result has the boolean value TRUE. No operation is processed if current result is FALSE. The current result is not modified by this operation

Allowed modifiers (none)

**Operand** output or internal boolean variable

Example:

```

(* EXAMPLES OF R OPERATIONS *)
RESETex: LD      true      (* current result := TRUE *)
          R      boo_var1  (* boo_var1 := FALSE *)
                          (* current result is not modified *)
          ST      boo_var2  (* boo_var2 := TRUE *)
          LD      false     (* current result := FALSE *)
          R      boo_var1  (* nothing done - boo_var1 unchanged *)

```

= **JMP operator**

Operation jumps to the specified label

Allowed modifiers C N

**Operand** label defined in the same IL program

Example:

(\* the following example tests the value of an analog selector (0 or 1 or 2) \*)  
 (\* to set one from 3 output booleans. Test "is equal to 0" is made with \*)  
 (\* the JMPC operator \*)

```

JMPex: LD      selector    (* selector is 0 or 1 or 2 *)
      BOO      (* conversion to boolean *)

```

```

        JMPC    test1      (* if selector = 0 then *)
        LD      true
        ST      bo0        (* bo0 := true *)
        JMP     JMPend     (* end of the program *)
test1:  LD      selector
        SUB     1          (* decrease selector: is now 0 or 1 *)
        BOO
        JMPC   test2      (* if selector = 0 then *)
        LD      true
        ST      bo1        (* bo1 := true *)
        JMP     JMPend     (* end of the program *)
test2:  LD      true      (* last possibility *)
        ST      bo2        (* bo2 := true *)
JMPend:                                (* end of the IL program *)

```

### = **RET operator**

**Operation** ends the current instruction list. If the IL sequence is a sub-program, the current result is returned to the calling program

Allowed modifiers C N

**Operand** (none)

Example:

(\* the following example tests the value of an analog selector (0 or 1 or 2) \*)  
 (\* to set one from 3 output booleans. Test "is equal to 0" is made with \*)  
 (\* the JMPC operator \*)

```

JMPex:  LD      selector   (* selector is 0 or 1 or 2 *)
        BOO          (* conversion to boolean *)
        JMPC   test1      (* if selector = 0 then *)
        LD      true
        ST      bo0        (* bo0 := true *)
        RET
        (* decrease selector *)

test1:  LD      selector
        SUB     1          (* selector is now 0 or 1 *)
        BOO          (* conversion to boolean *)
        JMPC   test2      (* if selector = 0 then *)
        LD      true
        ST      bo1        (* bo1 := true *)
        LD      1          (* load real selector value *)
        RET
        (* end - return 1 *)
        (* last possibility *)

test2:  RETNC           (* returns if the selector has *)
        (* an invalid value *)

        LD      true
        ST      bo2        (* bo2 := true *)
        LD      2          (* load real selector value *)
        (* end - return 2 *)

```



## = ")" operator

**Operation** executes a delayed operation. The delayed operation was notified by '('  
**Allowed modifiers** (none)  
**Operand** (none)

Example:

```
(* The following program interleaves delayed operations: *)  
(* res := a1 + (a2 * (a3 - a4) * a5) + a6; *)
```

```
Delayed: LD      a1      (* result := a1; *)  
         ADD(    a2      (* delayed ADD - result := a2; *)  
         MUL(    a3      (* delayed MUL - result := a3; *)  
         SUB     a4      (* result := a3 - a4; *)  
         )       (* execute delayed MUL - result := a2 * (a3-a4); *)  
         MUL     a5      (* result := a2 * (a3 - a4) * a5; *)  
         )       (* execute delayed ADD *)  
         ADD     a6      (* result := a1 + (a2 * (a3 - a4) * a5); *)  
         ST      res     (* result := a1 + (a2 * (a3 - a4) * a5) + a6; *)  
         ST      res     (* store current result in variable res *)
```

## = Calling sub-programs or functions

A sub-program or a function (written in any of the IL, ST, LD, FBD or "C" language) is called from the IL language, using its name as an operator.

**Operation** executes a sub-program or a function - the value returned by the sub-program or function is stored into the IL current result  
**Allowed modifiers** (none)  
**Operand** The first calling parameter must be stored in the current result before the call. The following ones are expressed in the operand field, separated by comas.

Example:

```
(* Calling program : converts an analog value into a time value *)
```

```
Main: LD      bi0  
      SUBPRO  bi1,bi2  (* call sub-program to get analog value *)  
      ST      result  (* result := value returned by sub-program *)  
      GT      vmax    (* test value overflow *)  
      RETC    (* return if overflow *)  
      LD      result  
      MUL    1000     (* converts seconds in milliseconds *)  
      TMR    (* converts to a timer *)  
      ST      tmval   (* stores converted value in a timer *)
```

```
(* Called sub-program named 'SUBPRO' : evaluates the analog value *)  
(* given as a binary value on three boolean inputs: in0, in1, in2 are the three boolean input parameters of the sub-program *)
```

```

LD      in2
ANA                                (* result = ana (in2); *)
MUL     2                          (* result := 2*ana (in2); *)
ST      temporary                  (* temporary := result *)
LD      in1
ANA
ADD     temporary                  (* result := 2*ana (in2) + ana (in1); *)
MUL     2                          (* result := 4*ana (in2) + 2*ana (in1); *)
ST      temporary                  (* temporary := result *)
LD      in0
ANA
ADD     temporary                  (* result := 4*ana (in2) + 2*ana (in1)+ana (in0); *)
ST      SUBPRO                     (* return current result to calling program *)

```

### = **Calling function blocks: CAL operator**

**Operation** calls a function block

Allowed modifiers C N

**Operand** Name of the function block instance.

The input parameters of the blocks must be assigned before the call using LD/ST operations sequence.

Output parameters are known if used.

Example1:

(\* Calling function block SR : SR1 is an instance of SR \*)

```

LD      auto_mode
AND     start_cmd
ST      SR1.set1
LD      stop_cmd
ST      SR1.reset
CAL     SR1
LD      SR1.Q1
ST      command

```

(\* FBD equivalent : \*)

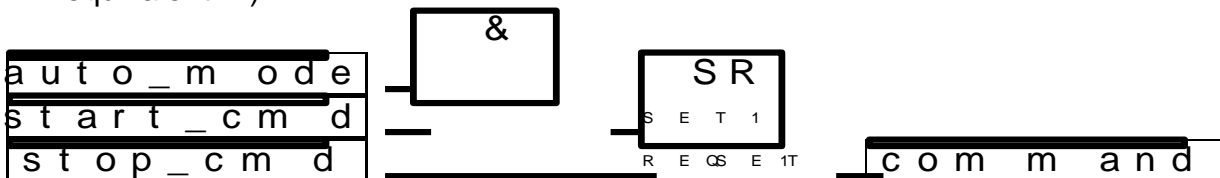

Example 2

(\*We suppose R\_TRIG1 is an instance of R\_TRIG block and CTU1 is an instance of CTU block\*)

```

LD      command
ST      R_TRIG1.clk
CAL     R_TRIG1
LD      R_TRIG1.Q

```

```

ST   CTU1.cu
LDN  auto_mode
ST   CTU1.reset
LD   100
ST   CTU1.pv
CAL  CTU1
LD   CTU1.Q
ST   overflow
LD   CTU1.cv
ST   result

```

(\* FBD equivalent: \*)

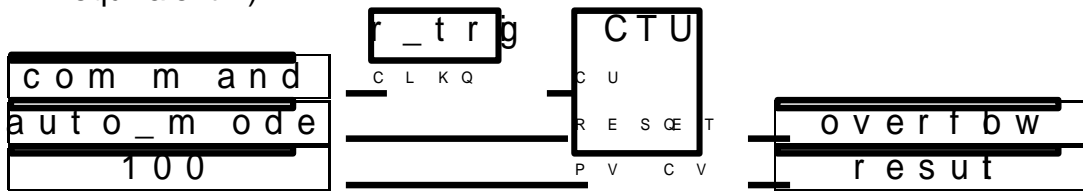

# Appendix F : How to Enable/Disable W-8x47's LAN2

## Important:

1. Please always set LAN2 as disabled if not using it.
2. Please always set a fixed IP to LAN1 (or LAN2 if it is enabled).

The default setting of LAN2 port of W-8047/8347/8747 & W-8046/8346/8746 is disabled. User must enable it before using LAN2 port.

Please open “Start” – “Setting” - “Control Panel” and then click on “Network and Dual-up Connections” to set as LAN2: DM9CE1 Enable or Disable

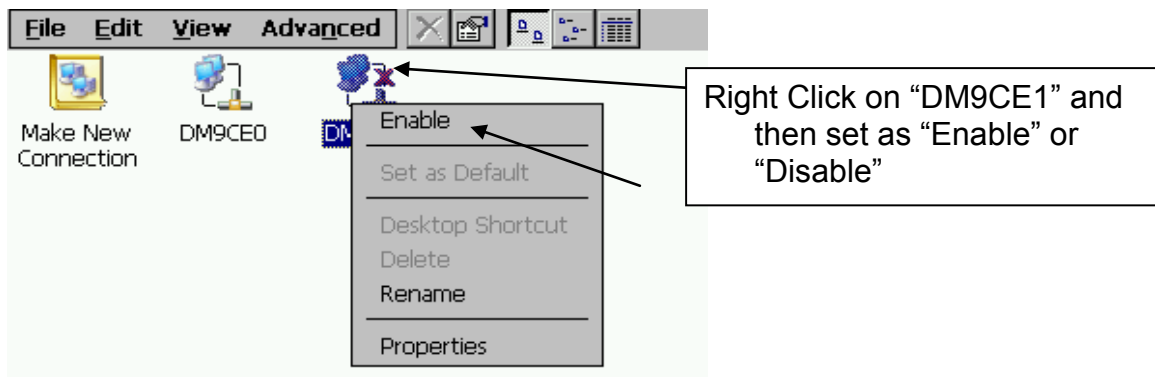
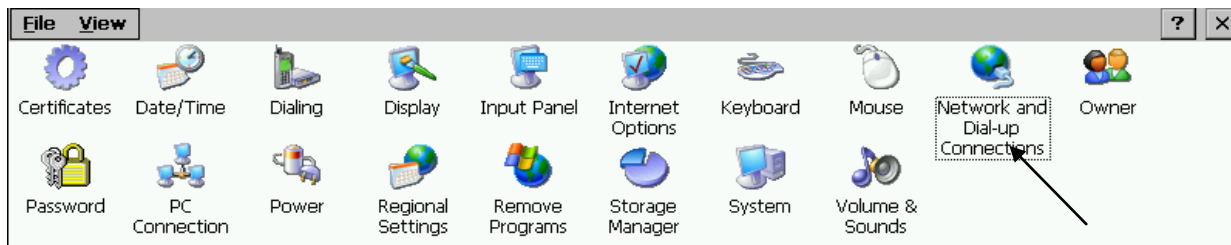

Then run “Start” – “Programs” – “Wincon Utility”, click “Save and Reboot” to save the setting.

