







1

What's in the box?

The shipping package contains this document and the following items:

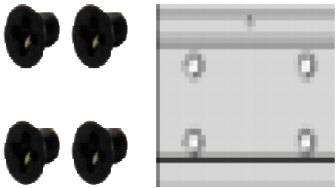
 <p>UA-5231 or UA-5231M UA-5231M-3GWA UA-5231M-4GE/4GC</p>		 <p>CA-0910 Cable</p>	 <p>MicroSD Card</p>
 <p>Screw Driver</p>	 <p>Pin Terminal x 16</p>	 <p>M3x6L Screw x4 44mm DIN-Rail Clip x1 (UA-5231M-4GE/4GC UA-5231M-3GWA UA-5231M Only)</p>	 <p>GSM Antenna (ANT-421-04) (UA-5231M-3GWA UA-5231M-4GE/4GC Only)</p>

[Technical Support]

UA Series User Manual:

http://ftp.icpdas.com/pub/cd/UA-Series/user_manual/UA-5231_UA-2241

ICP DAS Website: <http://www.icpdas.com>

Technical Support E-Mail: service@icpdas.com



2

Preparations for Devices

1. Power Supply: +12 ~ +48 VDC (Ex: DP-665)
2. Ethernet Hub or Switch (Ex: NS-205)
3. PC/NB: Can connect to the network and set the network

3

Hardware Connection

Connect the UA-5200 with the RJ-45 Ethernet port to an Ethernet hub/switch and PC. You can also link directly the UA-5200 to PC with an Ethernet cable.

After power is connected, please **【wait 1 minute】** for UA-5200 start-up procedure. When the "RUN/PWR" light starts flashing, it represents the boot is complete.

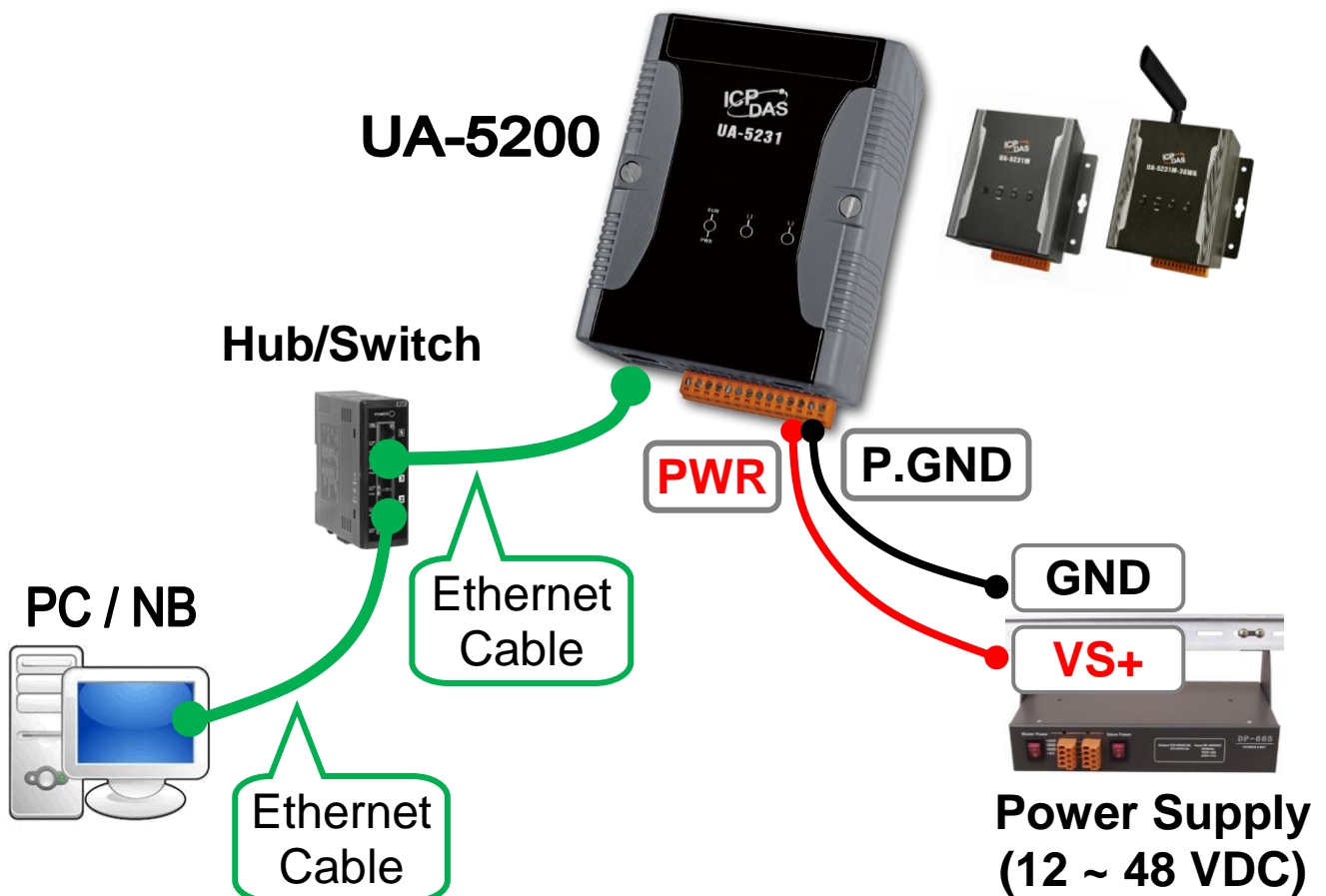

4

Network Connection

Factory Default Settings of UA-5200			
Network	IP	192.168.255.1	Assign UA-5200 a new IP setting according to your case.
	Netmask	255.255.0.0	
	Gateway	192.168.1.1	
OS Account	Username	root	After login, change your password ASAP. (Refer User Manual)
	Password	icpdas	
Web UI Account	Username	root	
	Password	root	

1. Change the **PC's IP** setting as following.

(Write down the PC original network settings before modify.)

IP	192.168.255.10
Subnet mask	255.255.0.0
Gateway address	192.168.1.1

2. Make sure the PC and UA-5200 is connecting through Ethernet. And then open a PC side browser. (Ex: Chrome, IE...)

3. Type **http://192.168.255.1** in the URL address. Use default Web UI username/password **root/root** to login the system.

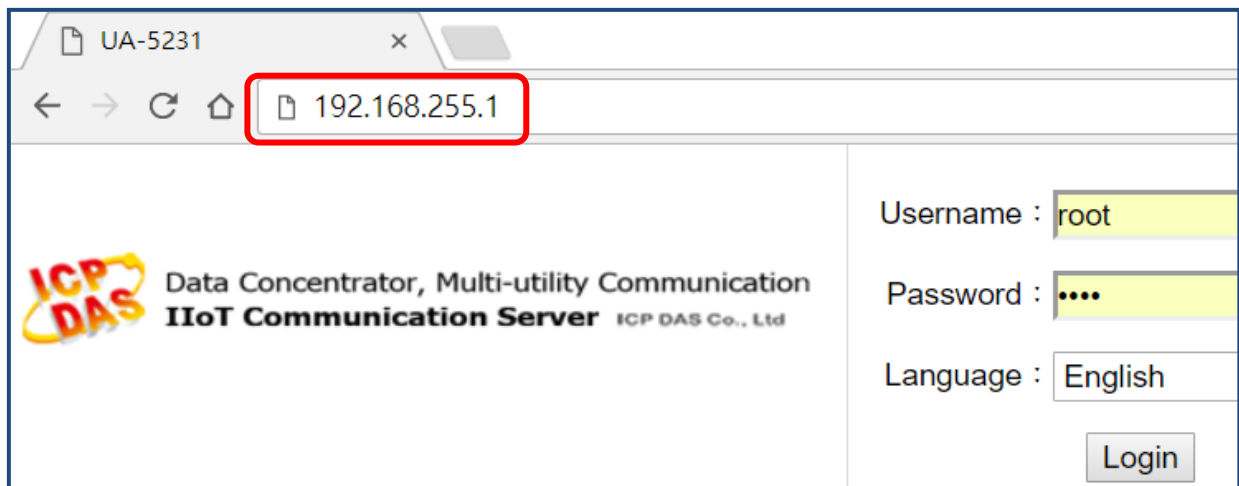

4. Click **【 System Setting 】** → **【 Network Setting 】** → **【 Network Setting(LAN1) 】** to change the IP setting by user network.

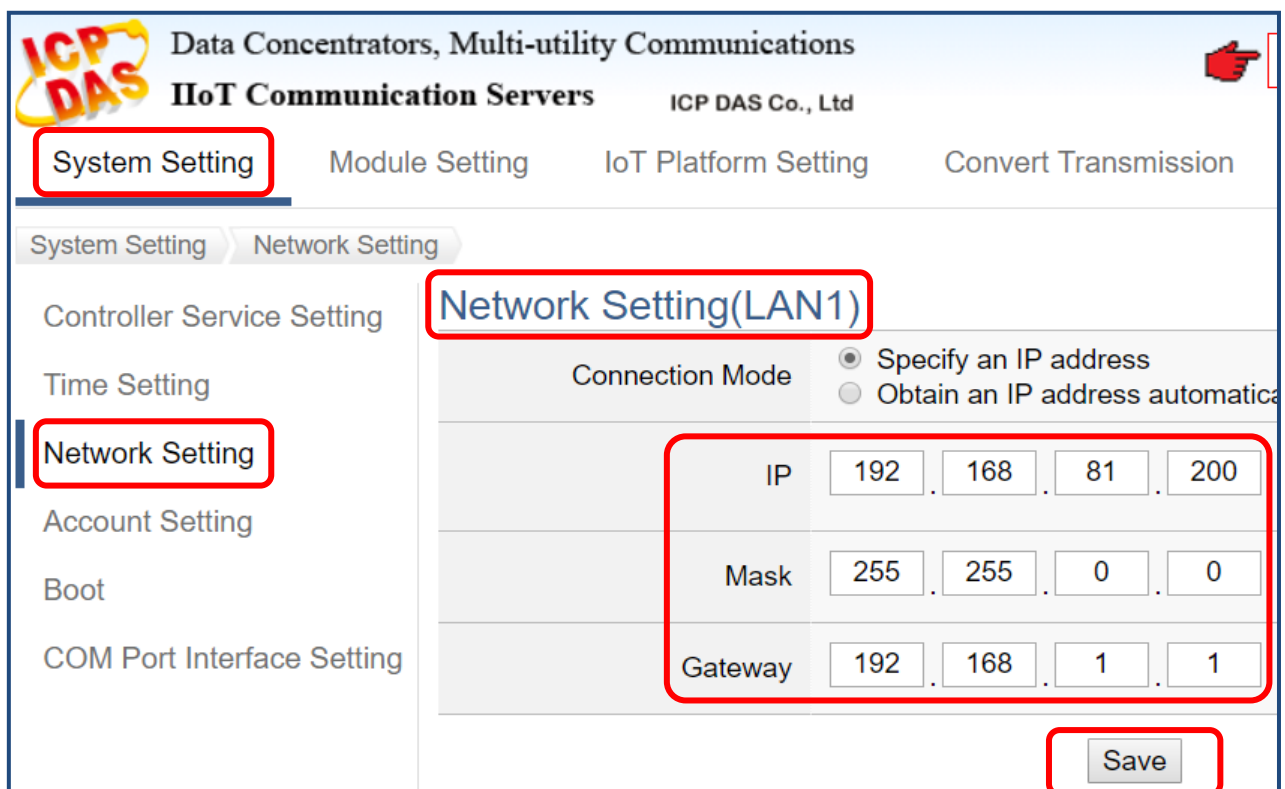

5. Save the IP setting, restore the PC original IP settings, and type the **new IP** in the browser as step-3 to login the Web UI of UA-5200. And then configure user's UA project.