



# tET-C4/tPET-C4

## Quick Start

v1.1, Feb. 2018

### What's in the box?

The package includes the following items:



tET/tPET-C4 Module x 1



Quick Start x1 (This Document)

### Related Information

- tET-C4/tPET-C4 Series Product Page:  
[http://www.icpdas.com/root/product/solutions/remote\\_io/ethernet\\_io/petl-7000\\_tpet\\_tet/tet-a4.html](http://www.icpdas.com/root/product/solutions/remote_io/ethernet_io/petl-7000_tpet_tet/tet-a4.html)
- Documentation & Firmware:  
<http://ftp.icpdas.com/pub/cd/tinymodules/napdos/tpet/>
- NS-205/NS-205PSE/DP-665 Product Page (optional):  
[http://www.icpdas.com/root/product/solutions/industrial\\_ethernet\\_switch/ns-205.html](http://www.icpdas.com/root/product/solutions/industrial_ethernet_switch/ns-205.html)  
[http://www.icpdas.com/root/product/solutions/industrial\\_ethernet\\_switch/ns-105pse.html](http://www.icpdas.com/root/product/solutions/industrial_ethernet_switch/ns-105pse.html)  
[http://www.icpdas.com/root/product/solutions/accessories/power\\_supply/dp-665.html](http://www.icpdas.com/root/product/solutions/accessories/power_supply/dp-665.html)

# 1

## Connecting the Power and Host PC

1) Make sure your PC has workable network settings.

Disable or well configure your Windows firewall and Anti-Virus firewall first, else the “**Search Servers**” on Chapter 5 may not work. (Please contact with your system Administrator)

2) Connect both the tET/tPET-C4 and your PC to the same sub network or the same Ethernet switch.

3) Supply power (PoE or +12~+48 Vdc) to the tET/tPET- C4.

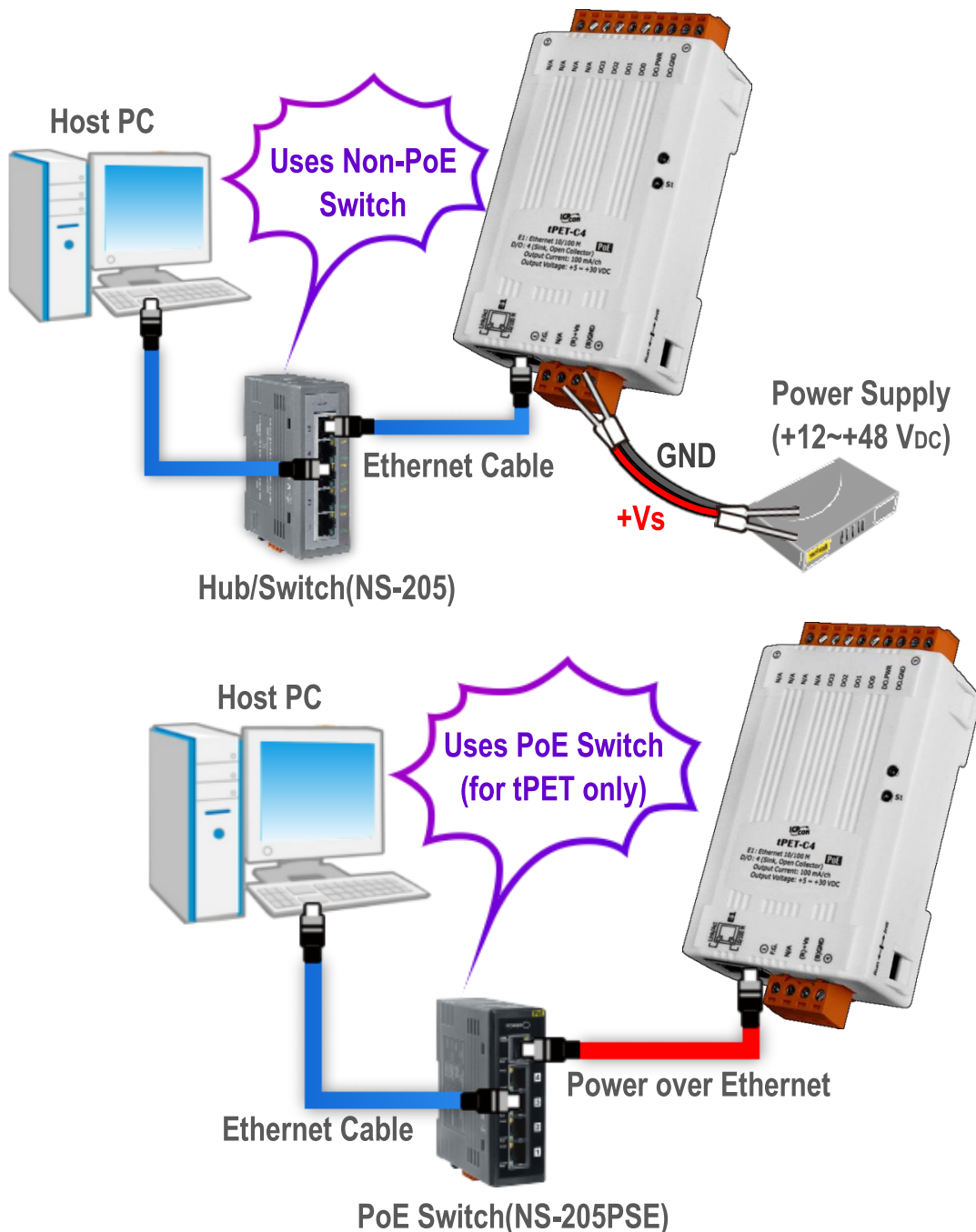

# 2

## Pin Assignments & Wiring Note

### ➤ Pin Assignments:

Terminal No.	Pin Assignment
E1	
01	F.G.
02	N/A
03	(R)+Vs
04	(B)GND

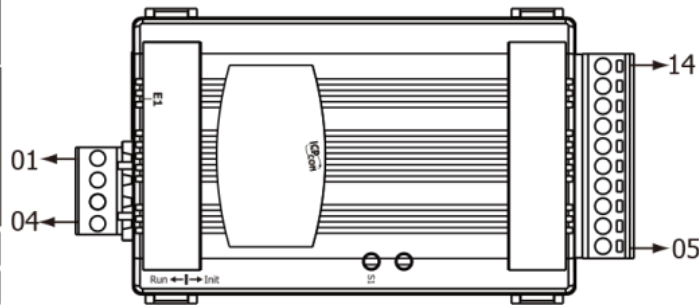

Terminal No.	Pin Assignment
14	N/A
13	N/A
12	N/A
11	N/A
10	DO3
09	DO2
08	DO1
07	DO0
06	DO.PWR
05	DO.GND

### ➤ Digital Output Wiring:

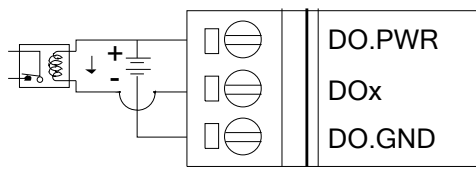
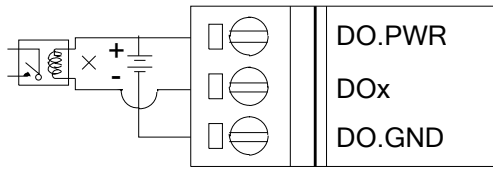
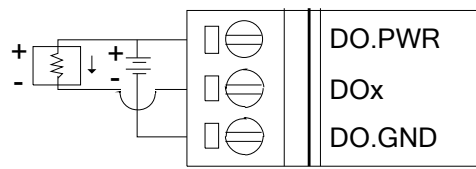
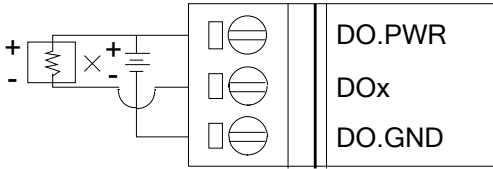
Output Type	Readback as 1	Readback as 0
Drive Relay	<p>Relay ON</p> 	<p>Relay OFF</p> 
		

# 3

## Wire the DO for Self-test

- 1) Use **output LED** to connect the **DO.PWR(Pin06)** and **DO0(Pin07)**.
- 2) Connect the **External Power +24V** to **DO.PWR(Pin06)**.
- 3) Connect the **External Power GND** to **DO.GND(Pin05)**.

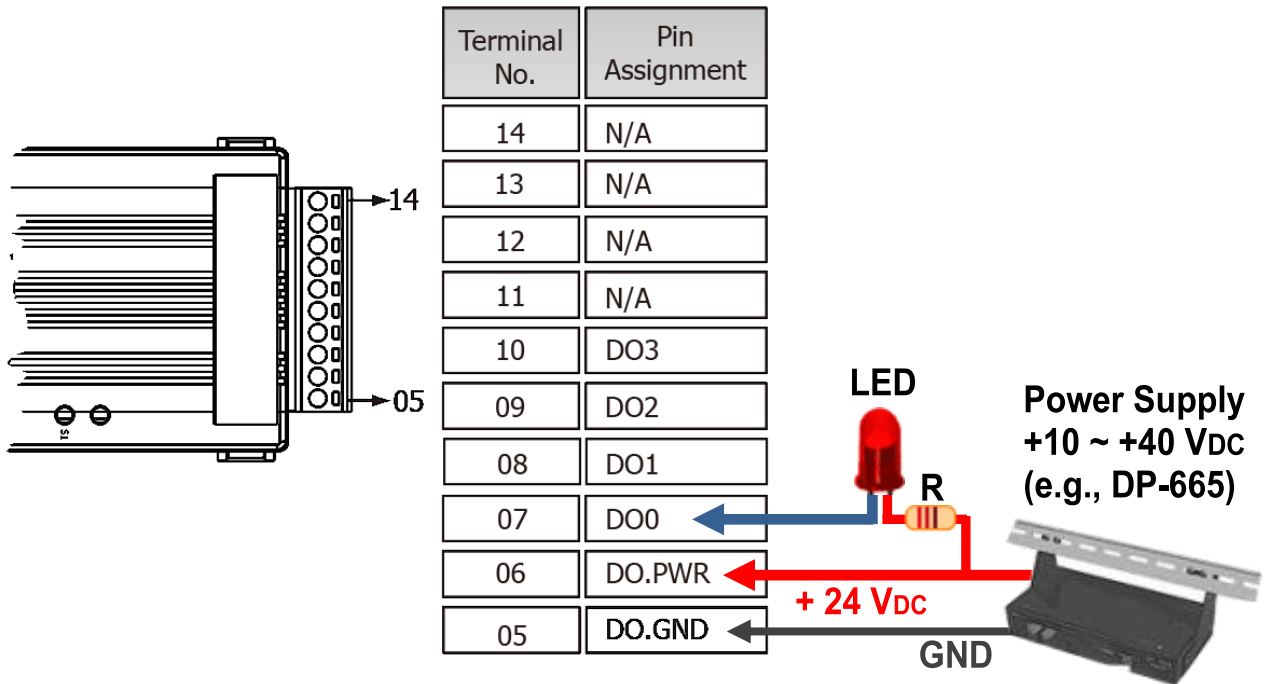

# 4

## Modbus Address

➤ (0xxxx) DO address:

Begin address	Points	Description	Bits Per Point	Range	Access Type
0 (0x0)	4	Digital Output	1	0: OFF 1: ON	R/W
.	.	.	.	.	.
235 (0xEB)	4	Power-on value for DO	1	0: OFF 1: ON	R/W/F
267 (0x10B)	4	Safe value for DO	1	0: OFF 1: ON	R/W/F

### ! Note

For detail “DI/DO Modbus Address” information, refer to Section 6.3 Modbus Register Table of user’s manual (<http://ftp.icpdas.com/pub/cd/tinymodules/napdos/tpet/document/>).

# 5

## Configuring Network Settings

- 1) Run the eSearch Utility.

The eSearch Utility is located at:

<http://ftp.icpdas.com/pub/cd/tinymodules/napdos/software/esearch/>



- 2) Click the “**Search Servers**” to search your tET/tPET-C4.
- 3) Double-click your tET/tPET-C4 to configure the settings

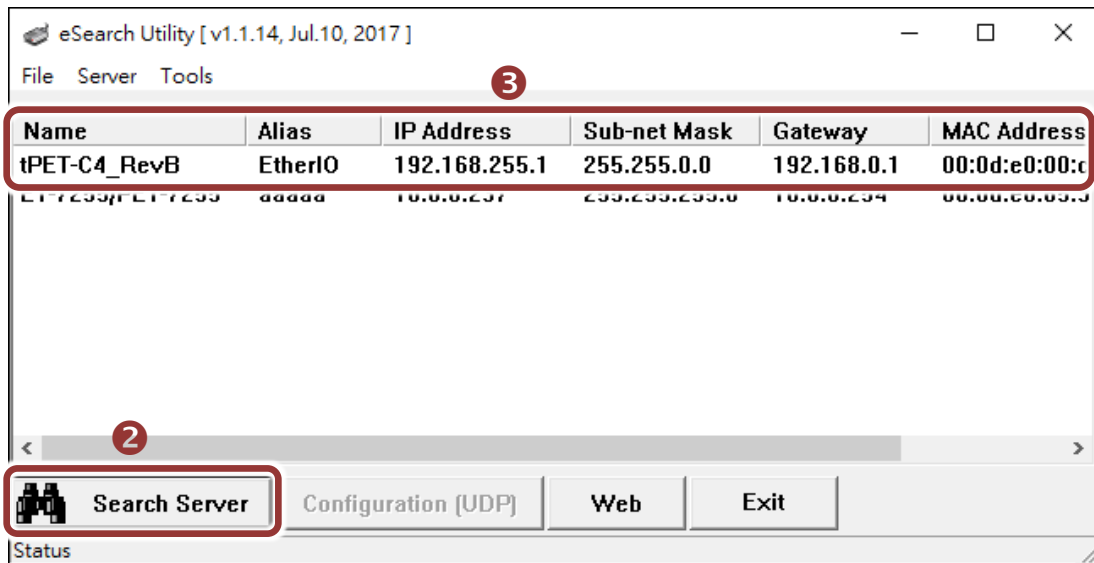

### Factory Default Settings of tET/tPET-C4:

IP Address	192.168.255.1
Subnet Mask	255.255.0.0
Gateway	192.168.0.1

- 4) Contact your Network Administrator to obtain a correct network configuration (such as **IP/Mask/Gateway**). **Enter the network settings** and click “**OK**”. **⚠ Note: The tET/tPET-C4 will use the new settings 2 seconds later.**

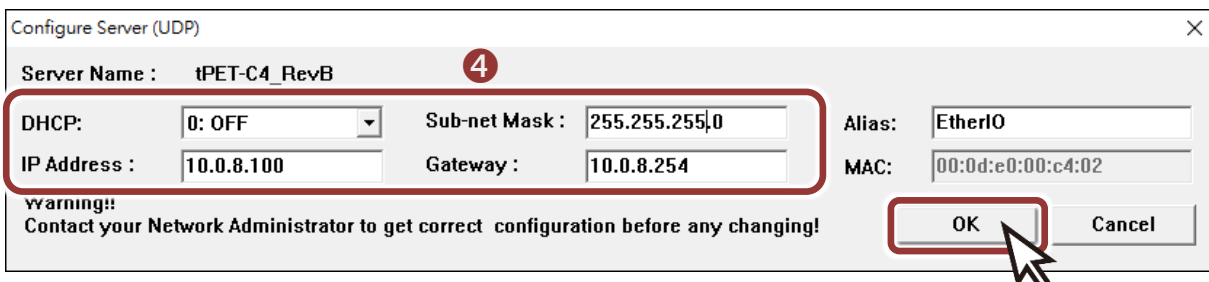

# 6

## Testing your tET/tPET Module

- 1) Wait 2 seconds and click “**Search Servers**” button again to ensure the tET/tPET-C4 is working well with new configuration.
- 2) Click the name of tET/tPET-C4 to select it.
- 3) Click the “**Web**” button to log in to the web configuration pages.  
(Or enter the URL address of the tET/tPET-C4 in the address bar of the browser.)

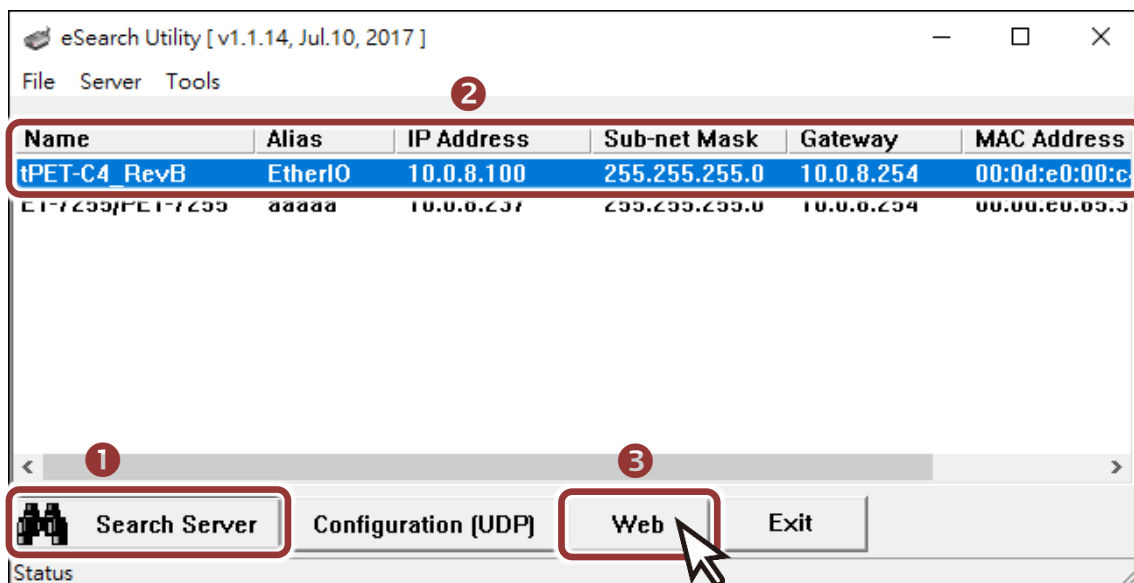

Note that if you intend to use Internet Explorer, ensure that the cache function is disabled in order to prevent browser access errors, please disable your Internet Explorer cache as follow: **(If you are not using IE browser, please skip this step.)**

Step1: Click “**Tools**” >> “**Internet Options...**” in the menu items.

Step 2: Click “**General**” tab and click the “**Settings...**” button in Temporary Internet files frame.

Step3: Click “**Every visit to the page**” and click the “**OK**” in Settings box and Internet Options box.

For more detail, refer to [“FAQ: How to avoid a browser access error that causes a blank page to be displayed when using Internet Explorer”](#)

4) Enter the password in the “login password” field and click “Submit”.

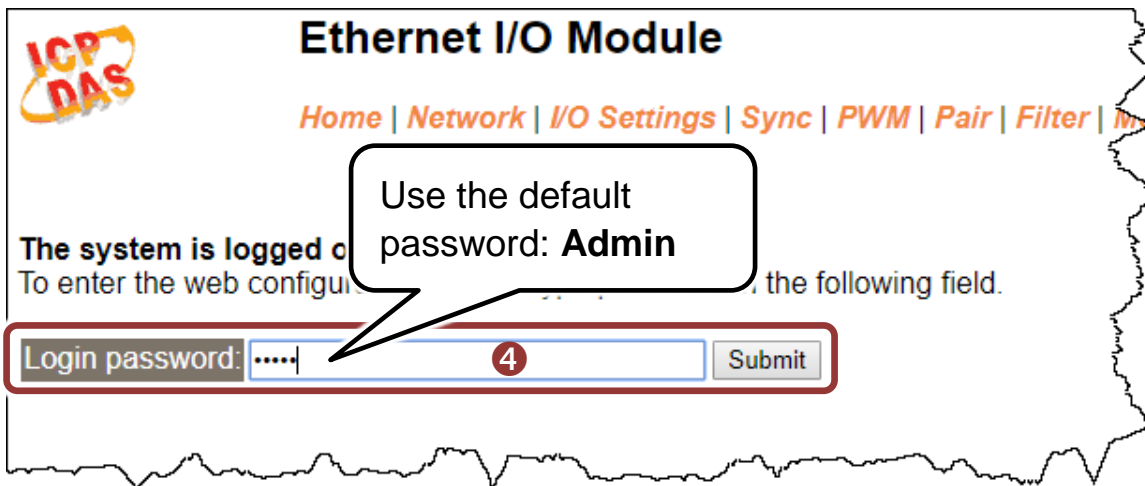

5) In the “Home” page allows a simple test to be performed to verify the Digital Output functionality.

Pair-Connection Settings		Port 1
Server Mode:		Server
Remote Server IP:		Disabled
Remote TCP Port:		Disabled

6) In the “Digital I/O” section, click the “DO0” button to ON (Red).

7) Check DO0 (Pin07) of output LED state for high.

