



DS-2200 Series Quick Start

V1.0, Mar. 2020

What's in the box?

The package includes the following items:



DS-2200 Series Module x 1



Quick Start x1 (This Document)

Related Information

- DS Series Product Page:
http://www.icpdas.com/root/product/solutions/industrial_communication/pds/tds-700.html
- Documentation & Firmware:
<http://ftp.icpdas.com/pub/cd/tinymodules/napdos/ds-2200/document/>
<http://ftp.icpdas.com/pub/cd/tinymodules/napdos/ds-2200/firmware/>
- NS-205/NS-205PSE Product Page (optional):
http://www.icpdas.com/root/product/solutions/industrial_ethernet_switch/ns-205.html
http://www.icpdas.com/root/product/solutions/industrial_ethernet_switch/ns-105pse.html

1

Connecting the Power and Host PC

1) Make sure your PC has workable network settings.

Disable or well configure your Windows firewall and Anti-Virus firewall first, else the “**Search Servers**” on **Chapter 4** may not work. (Please contact with your system Administrator)

2) Connect both the DS-2200 and your PC to the same sub network or the same Ethernet switch.

3) Supply power (PoE or +12~+48 V_{DC}) to the DS-2000.

⚠ Note : Please use the first RJ-45 jack (ETH1) to connect the PoE Switch when using the PoE to power. The second RJ-45 jack (ETH2) doesn't support the PoE function

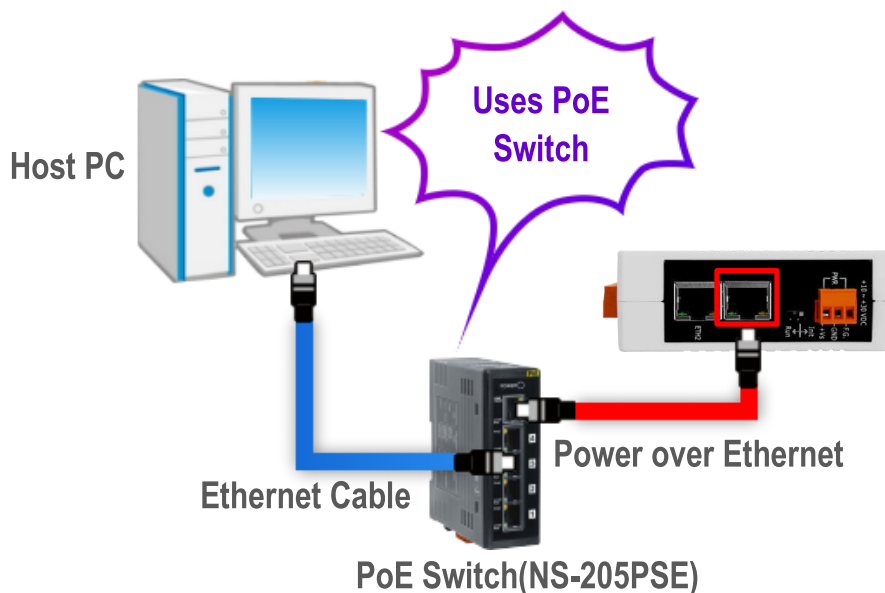
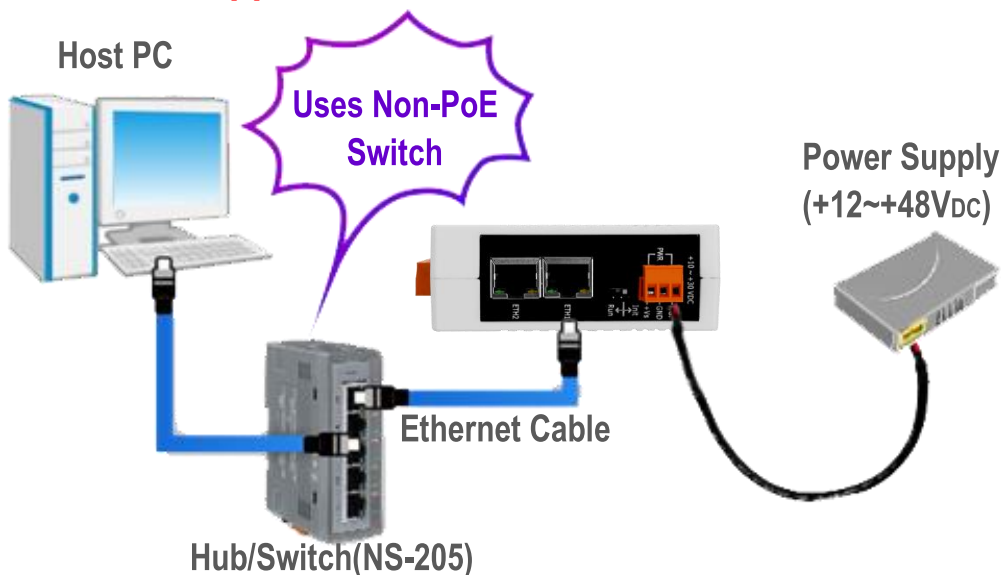

2 Self-Test Wiring

Wiring Notes for RS-232/485/422 Interfaces:

☑: Here, the RS-232 and RS-485 wiring is used as an example.

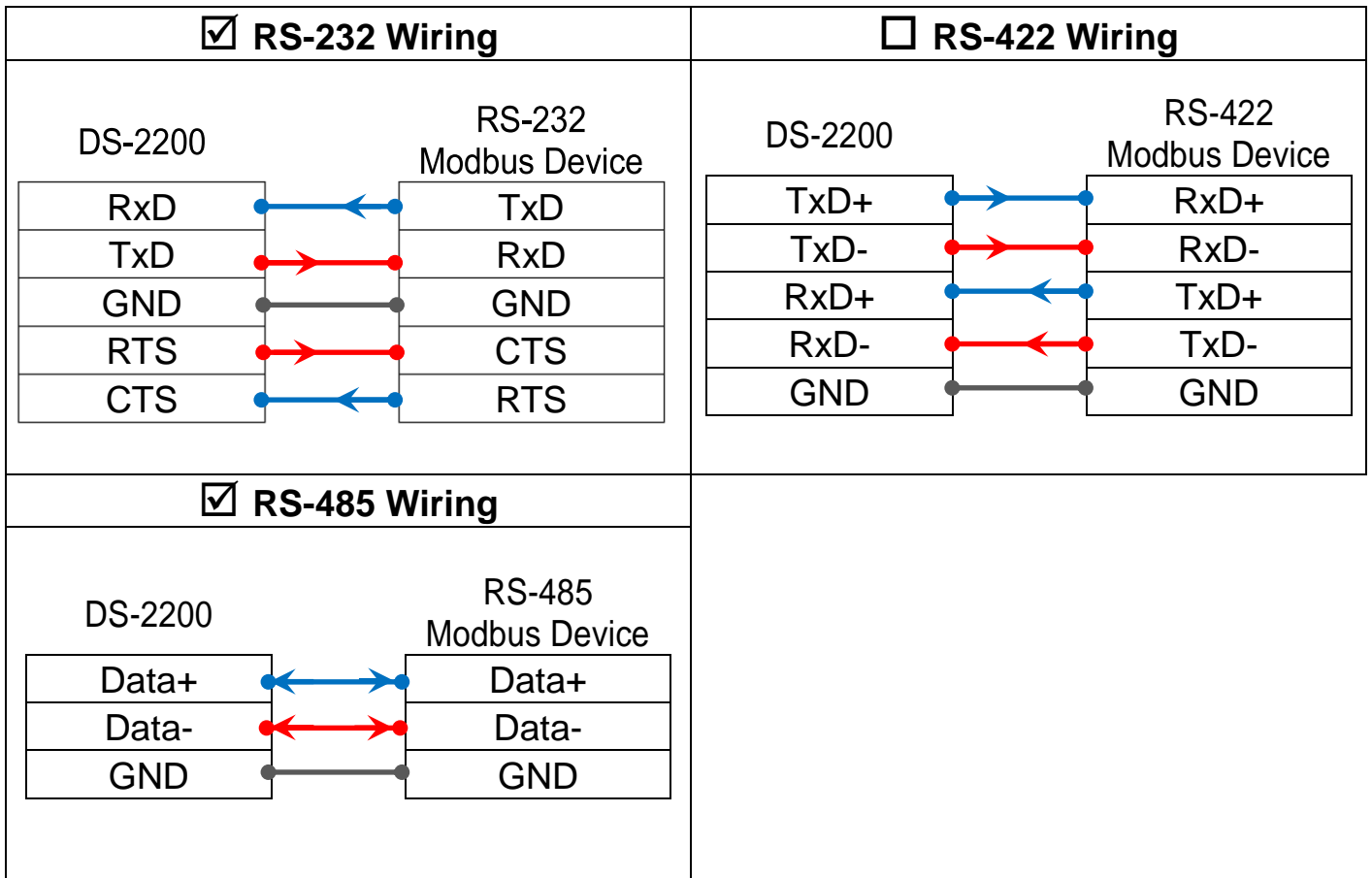

While using RS-485 modules, you can not wire the Data+ with Data- signals for self-test. But you can test two RS-485 ports by wiring the Data1+ with Data2+ signals, and wiring the Data1- with Data2- signals. Then send data to one and receive data from another.

3

Installing Software on Your PC

Install VxComm Utility, which can be obtained from the web site:

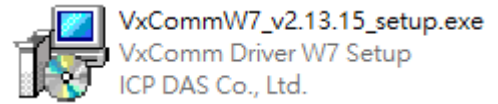

 http://ftp.icpdas.com/pub/cd/8000cd/napdos/driver/vxcomm_driver/windows/

 ftp://ftp.icpdas.com/pub/cd/8000cd/napdos/driver/vxcomm_driver/windows/

4

Configuring Network Settings

- 1) Double-click the VxComm Utility shortcut on the desktop.
- 2) Click the “**Search Servers**” to search your DS-2200.
- 3) Double-click the name of DS-2200 to open the “**Configure Server (UDP)**” dialog box.

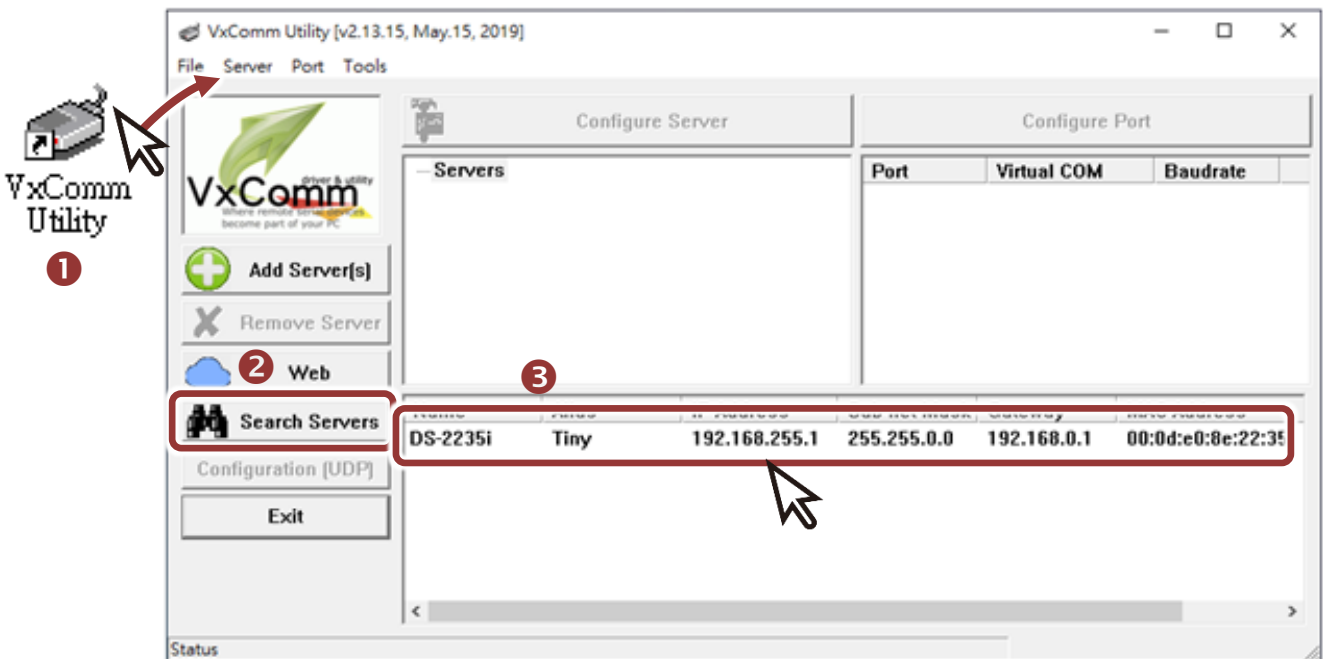

Factory Default Settings of DS-2200:

IP Address	192.168.255.1
Subnet Mask	255.255.0.0
Gateway	192.168.0.1

- 4) Contact your Network Administrator to obtain a correct network configuration (such as IP/Mask/Gateway). Enter the network settings and click “OK”. **⚠ Note: The DS-2200 will use the new settings 2 seconds later.**



5 Configuring Virtual COM Ports

- 1) Wait 2 seconds and click “**Search Servers**” button again to ensure the DS-2200 is working well with new configuration.
- 2) Click the name of DS-2200 to select it.

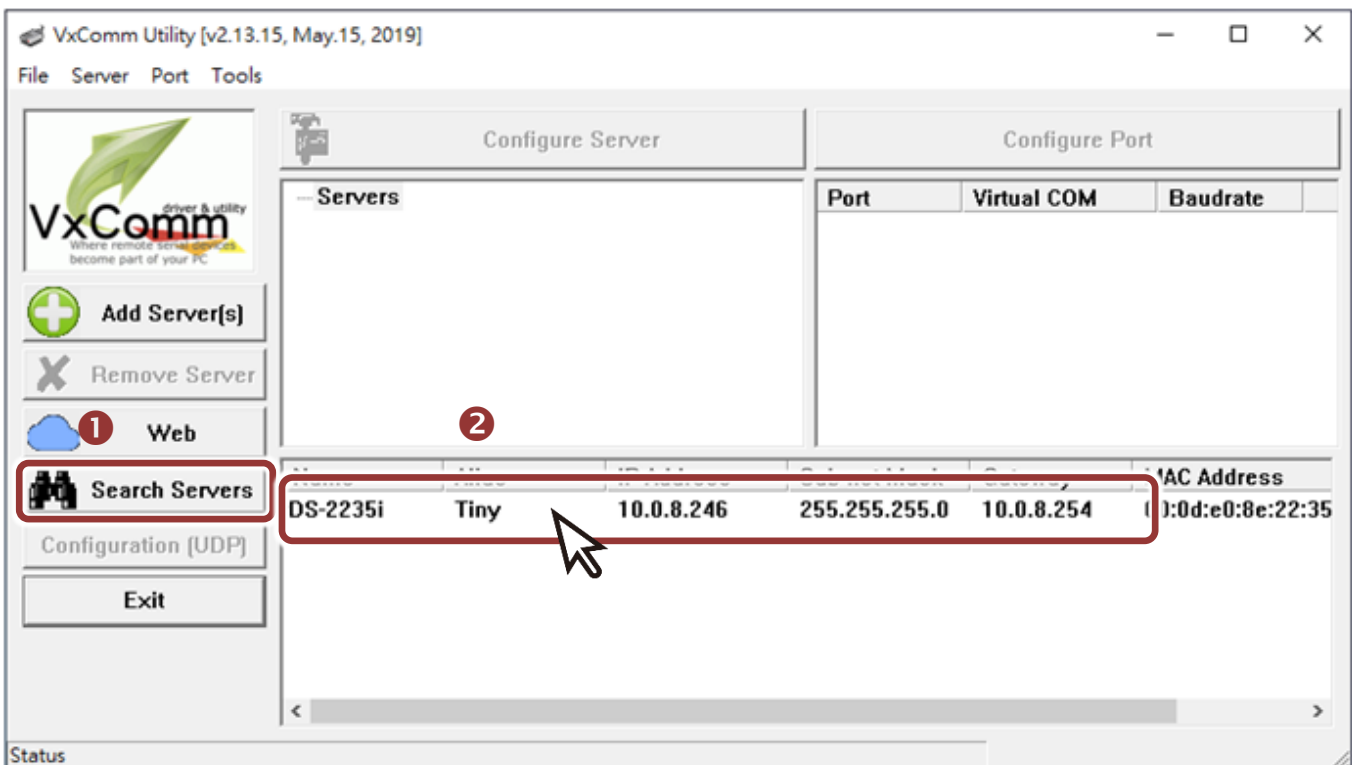

3) Click the “Add Server[S]” button.

4) Assign a COM Port number and click “OK” to save your settings.

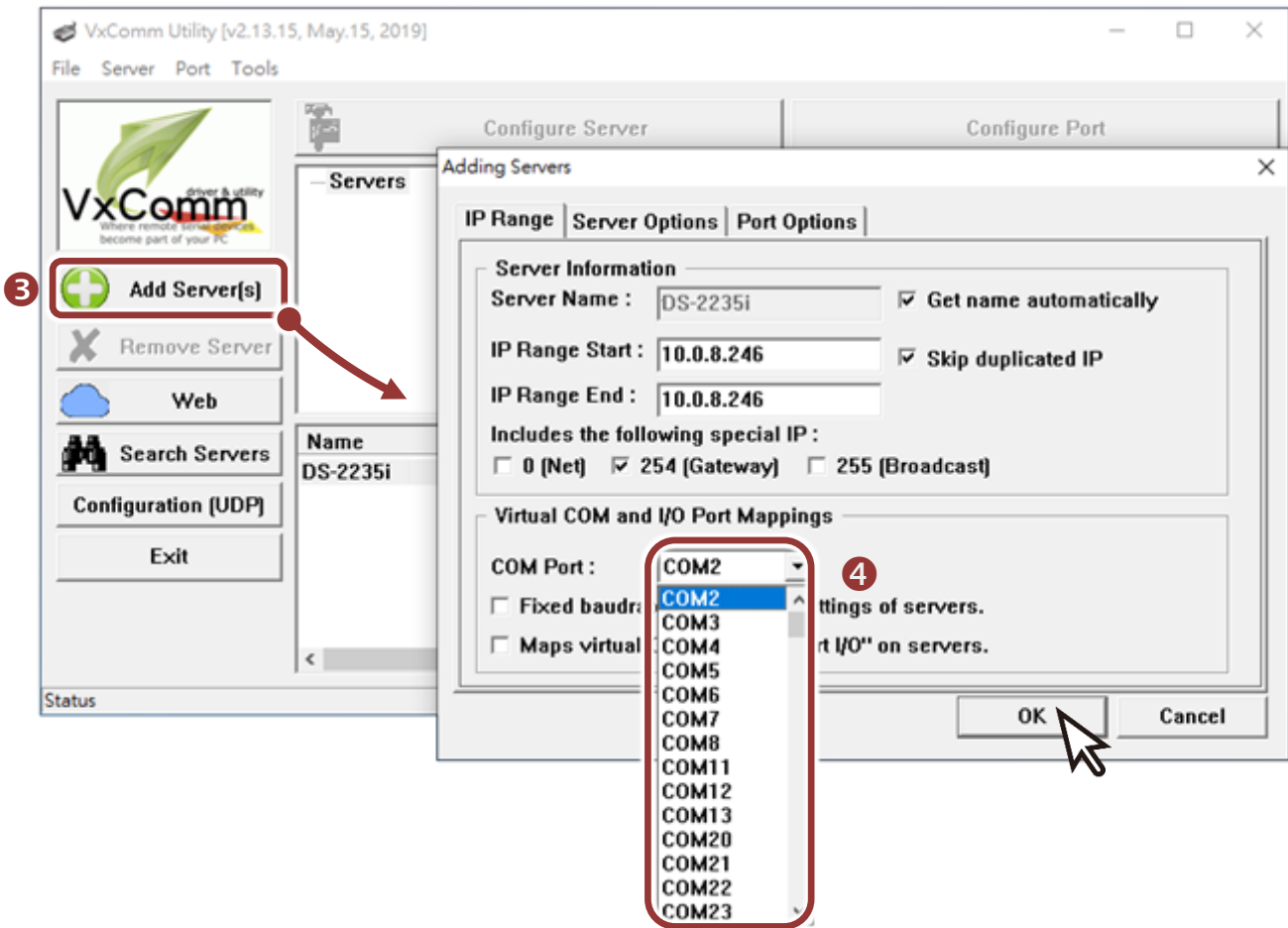

5) Click on DS-2200 name and check the virtual COM Port mappings on the PC.

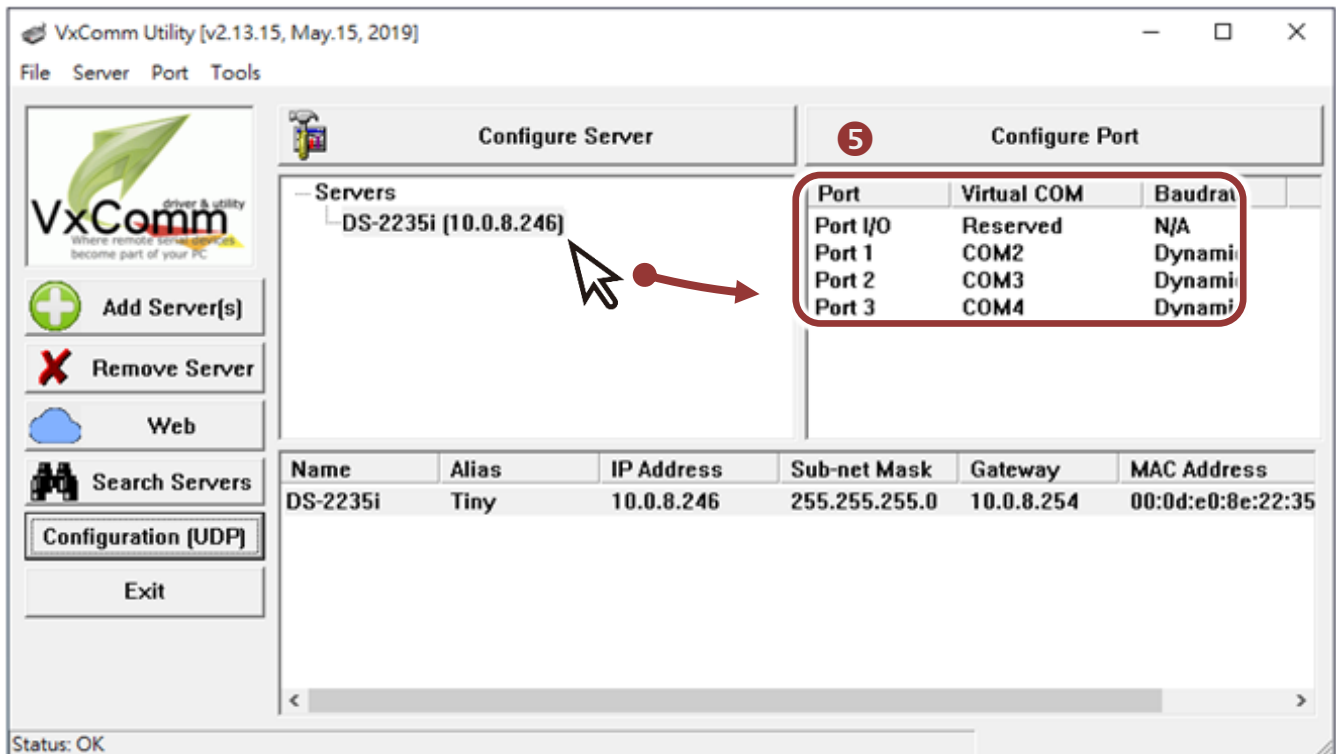

6) Click the “Restart Driver” item in the “Tools” menu to display the “VxComm Utility: Restarting Driver” dialog box.

7) Click the “Restart Driver” button.

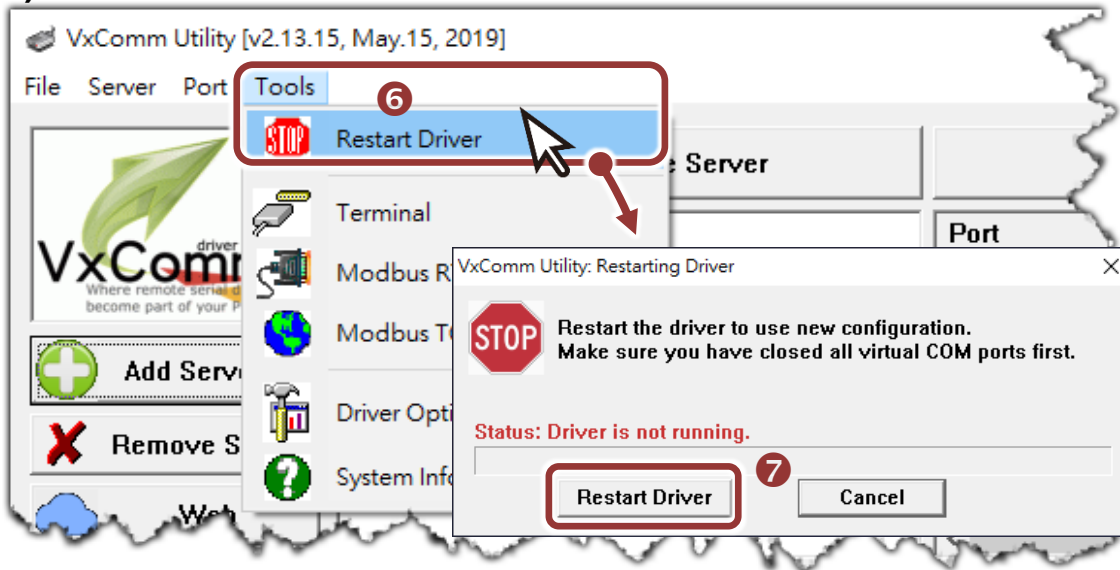

6 Self-Test

1) Right click Port1 and then choose the “Open COM Port” item.

2) Check that the configuration of the COM Port is correct and then click the “Open COM” button.

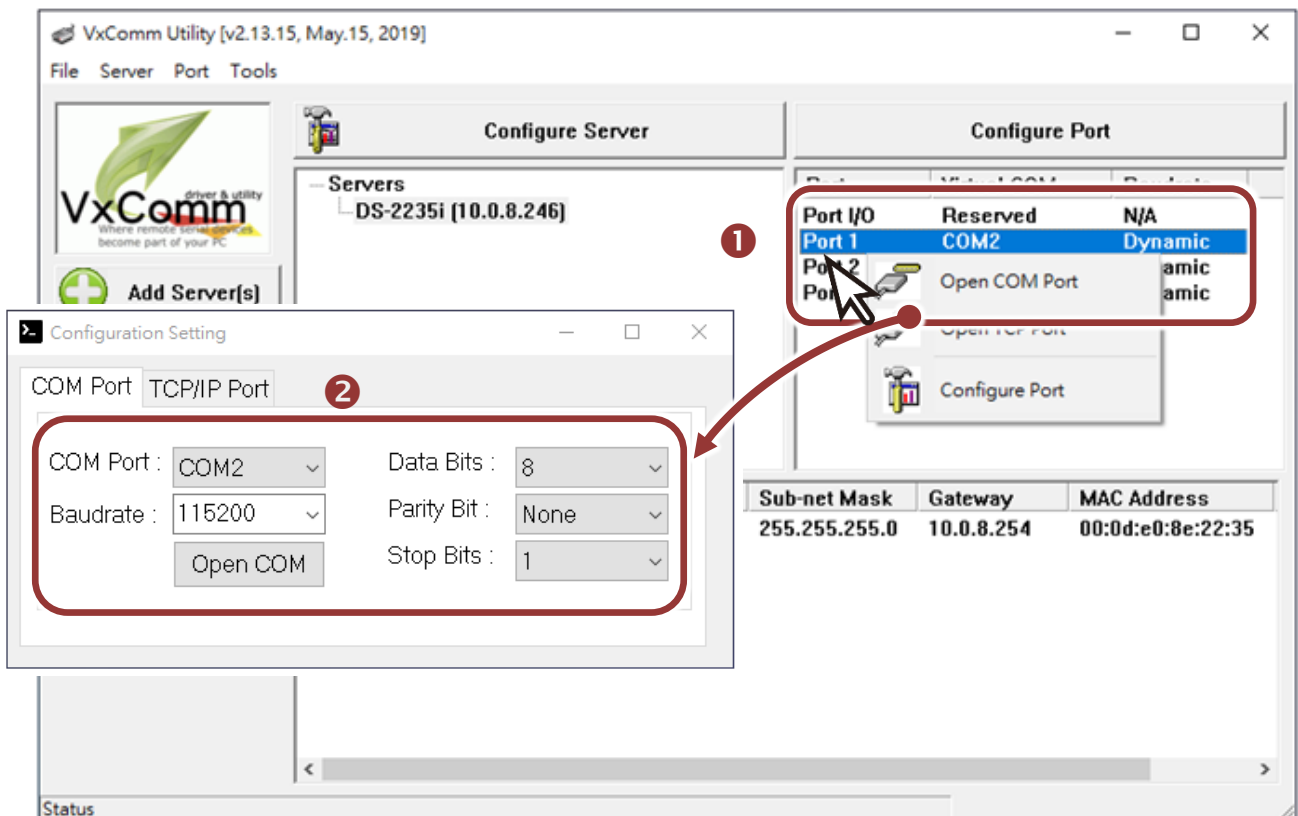

- 3) Type a string in the “**Send**” field.
- 4) Click the “**Hex/Text**” option in the “**Display**” section.
- 5) Click the “**Send**” button to send the message.
- 6) If a response is received, it will be displayed in the received field.

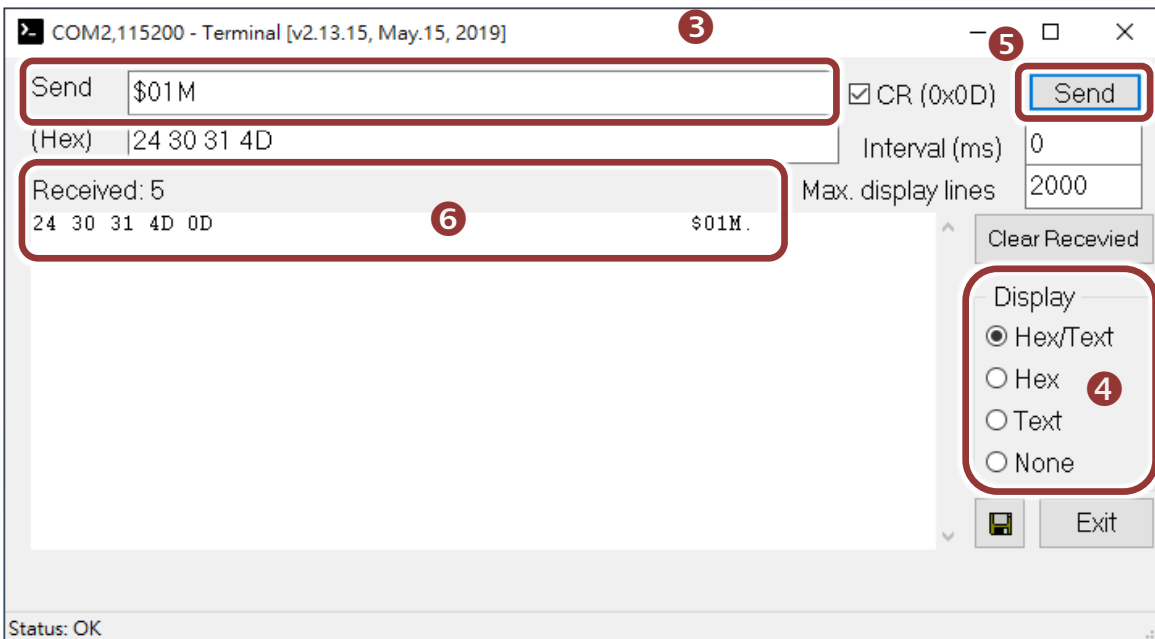

Note that if you intend to use Internet Explorer, ensure that the cache function is disabled in order to prevent browser access errors, please disable your Internet Explorer cache as follow: **(If you are not using IE browser, please skip this step.)**

Step1: Click “**Tools**” >> “**Internet Options...**” in the menu items.

Step 2: Click “**General**” tab and click the “**Settings...**” button in Temporary Internet files frame.

Step3: Click “**Every visit to the page**” and click the “**OK**” in Settings box and Internet Options box.