

PM-4324 Series Quick Start

1. Shipping Package

This shipping package contains the following items

1 x PM-4324 module



1 x Quick Start
(This Document)



Screw Driver x 1



Cable ties x 24



1.1. Caution & Warning



The meter contains hazardous voltages, and should never be disassembled. Failing to follow this practice will result in serious injury or death. Any work on or near energized meters, meter sockets, or other metering equipment could induce a danger of electrical shock. It is strongly recommended that all work should be performed only by qualified industrial electricians and metering specialist. ICP DAS assumes no responsibility if your electrical installer does not follow the appropriate national and local electrical codes.

ICP DAS assumes no liability for any damage resulting from the use of this product. ICP DAS reserves the right to change this manual at any time without notice. The information furnished by ICP DAS is believed to be accurate and reliable. However, no responsibility is assumed by ICP DAS for its use, not for any infringements of patents or other rights of third parties resulting from its use.

1.2. Product Warranty & Customer Support

ICP DAS warrants all products free from defects in material and workmanship for a period of one year from the date of shipping. During the warranty period, we will, at our position, either repair or replace any product that proves to be defective. To report any defect, please contact : **+886-3- 597-3366** or service@icpdas.com.

Documentation & Utility: <http://ftp.icpdas.com/pub/cd/powermeter/pm-4324/>

1.2.1. Limitation of Warranty

This warranty does not apply to defects resulting from unauthorized modification, misuse, or use for reason other than electrical power monitoring. The supplied meter is not a user-serviceable product.

2. Installation

Please use the soft dry clothes to clean the instrument.

Please do not use any chemical or detergent or volatile solvents to clean the instrument, in order to avoid any possibility of the cover damage.

2.1. Dimension 134mm (length) × 237mm (wide) × 52mm (high)

- Products come with external split type clip-on CT's. Disconnect the CT's or use other CT's is highly prohibited.
- Please read this operation manual carefully before using.
- Please re-confirm the measure position.
- Reconfirm the RST (ABC) phase sequence of the power system.
- Meter auxiliary power for PM-4324 series is AC +100V ~+240V.

2.2. Voltage Input

1. PM-4324 series: Input Voltage up to 500V.

For any higher Input Voltage large than 500V, please add the PT (power transformer), and Change PT RATIO setup.

2. Confirm the RST (ABC) phase sequence.

2.3. Current Input

1. The external CT's are fragile, please handle with care.
2. The current input of PM-4324 series is in mA range. Only the ex-factory attached CT's can be used. The other CT's, for example, from panel will damage the instrument due to its large current (around 5A)
3. When more than one smart meter (PM-4324 series) are installed, please do not disconnect the CT with its original meter and mix use with each other. Since each set of smart meter (PM-4324 series) and its attached split type clip-on CT are calibrated set by set. The mix use may cause wrong measurements.
4. To install CT's correctly, please ensure the CT lines sequences is right before clip the CT's onto the power cable of the monitoring equipment. (Detail will be found in next section)



5. **When measuring the current, the secondary circuit of a CT should never be opened when a load is passing through its primary. Make sure you always open the CT clip to detach the CT before removing the terminal lines. Otherwise, it will cause severe injury.**

6. Please handle with extra care, especially when the operation space of CT's is limited.
7. The current direction must follow K-L marked on CT's.
8. Please select the right size CT's for different size of monitoring equipment cables:
power cable diameter $\Phi 10$ use 60A CT , $\Phi 10 \sim \Phi 16</math> use 100A CT , $\Phi 16 \sim \Phi 24</math> use 200A CT , $\Phi 24 \sim \Phi 36</math> use 300A CT or 400A CT .$$$
9. The maximum current value cannot exceed the CT rating.

2.4. Connection

- PM-4324 Series

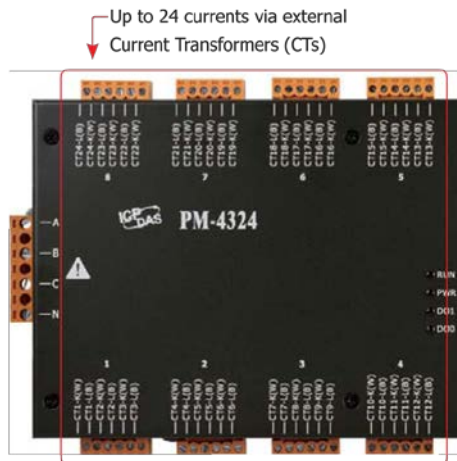

Please firstly check the current input terminal, and then in white black, white black, white black wire sequences (CT1-K, CT1-L, CT2-K, CT2-L, CT3-K, CT3-L). Then connect the CT's, and close the CT clip. Make sure the arrow direction sign on CT's follows current flow direction (K→L)

Note: it must be in the same direction.

Connect the voltage input terminal N C B A. for PM-4324, in the three phase order as follows on N C B A.

Attention please!! For 3P3W-2CT, connect in N C A phase sequence, do not connect phase B (Check the diagram).

2.5. CT's installation steps

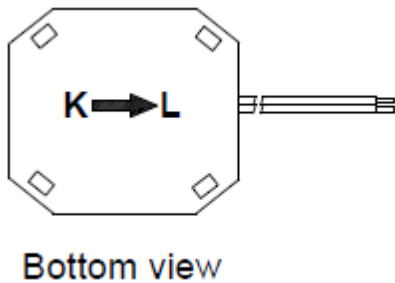

- At the bottom of the CT, there is a "K→L" mark.

- Open the CT clip.



- Make sure the power current direction follow the "K→L" mark on the CT and then close the CT clip.
- Installation steps finished.

2.6. Wiring

- 1P2W-1CT (PM-4324)

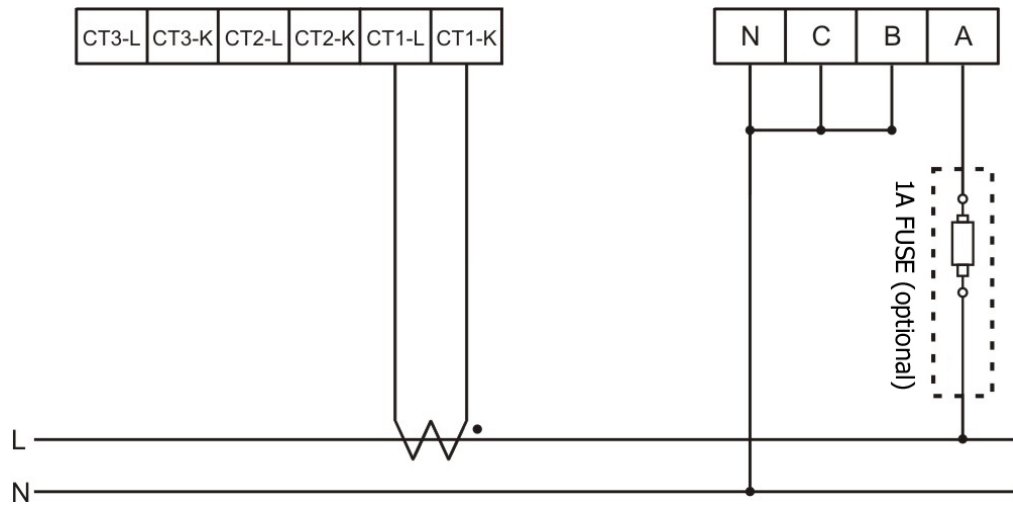

- 1P3W-2CT (PM-4324)

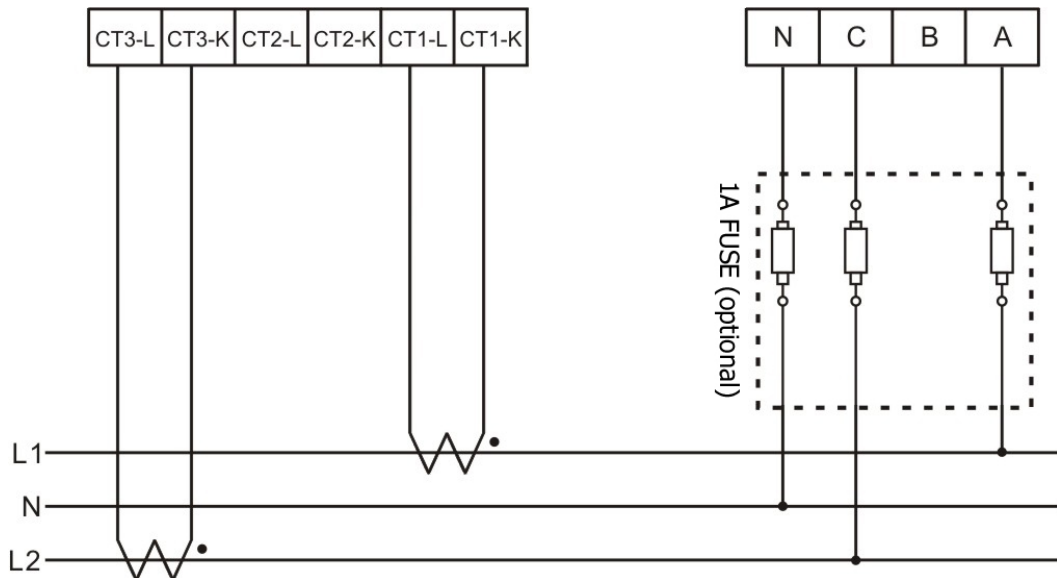

- 3P3W-2CT (PM-4324)

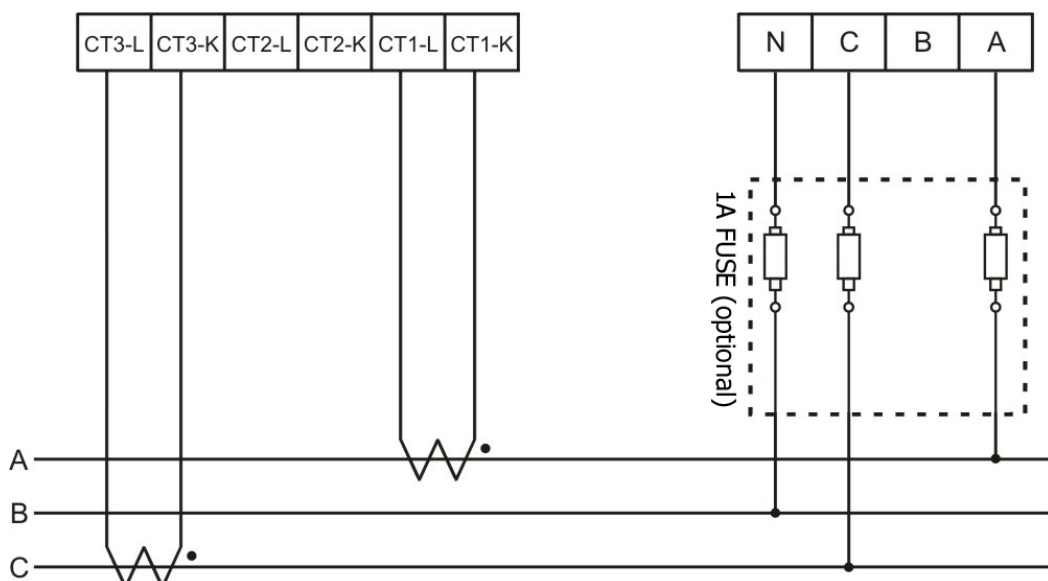

● 3P3W-3CT (PM-4324)

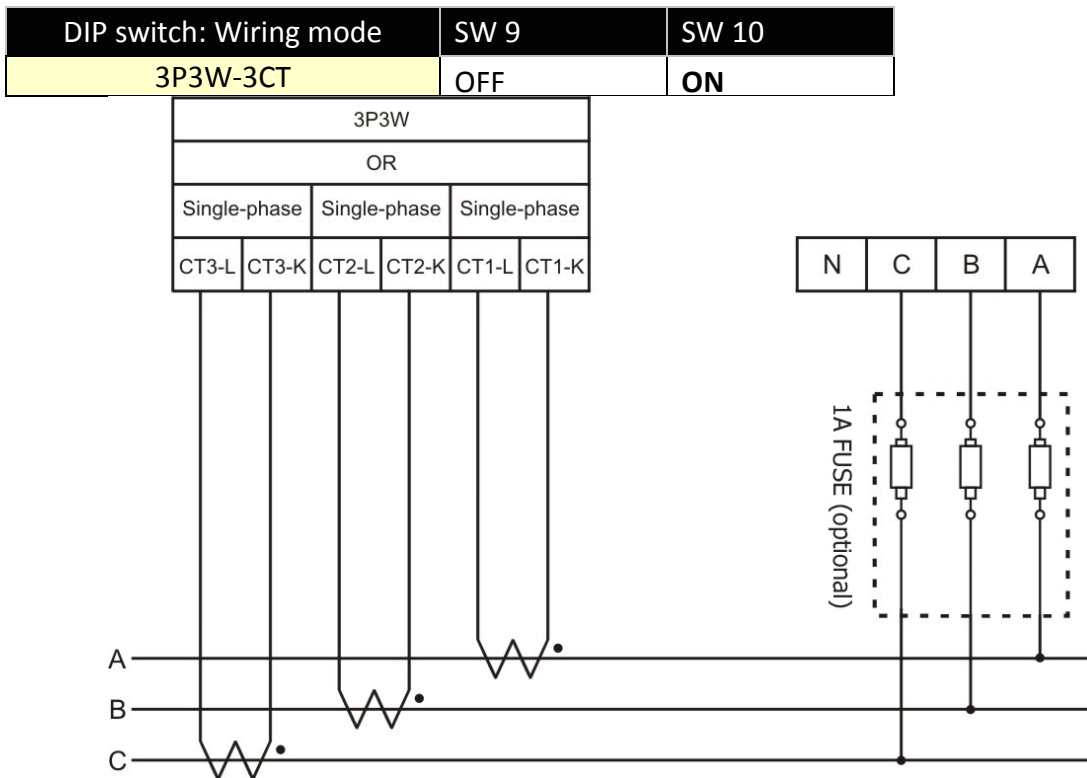

● 3P4W-3CT (PM-4324)

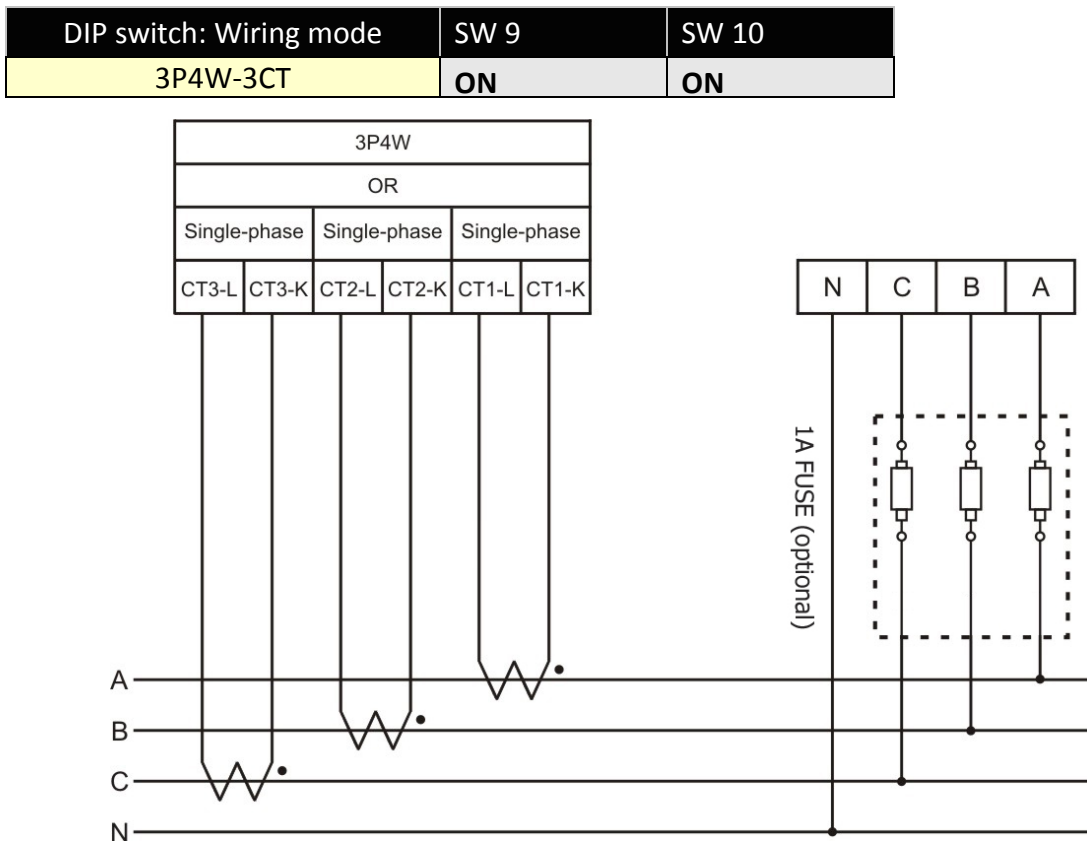

● **LED Indicator**

- RUN: Green, light up after communication ready. LED will flash when the unit is processing communication.
- PWR: Red, Power on LED always on.
- DO0: Green. LED DO0 will light up, when DO0 is "ON".
- DO1: Green. LED DO1 will light up, when DO1 is "ON".

Communication

2.7. RS-485 & CAN setting

- Default setting for RS-485: **19200, n, 8, 1** ,for CAN: **125K bps**
- DIP switch (SW1-SW6) is used for Modbus address(or CANopen Node ID) setting, default is 1, i.e. all OFF
For example: Modbus address(or CANopen Node ID) is 10 · find the table of DIP switch 1-6 is **ON, OFF, OFF, ON, OFF, OFF**
- SW1 – SW6 setting

Setting Modbus-RTU address/ CANopen Node ID for communication (1-64)

Modbus Address	SW 1	SW 2	SW 3	SW 4	SW 5	SW 6
1	OFF	OFF	OFF	OFF	OFF	OFF
2	ON	OFF	OFF	OFF	OFF	OFF
3	OFF	ON	OFF	OFF	OFF	OFF
4	ON	ON	OFF	OFF	OFF	OFF
5	OFF	OFF	ON	OFF	OFF	OFF
6	ON	OFF	ON	OFF	OFF	OFF
7	OFF	ON	ON	OFF	OFF	OFF
8	ON	ON	ON	OFF	OFF	OFF
9	OFF	OFF	OFF	ON	OFF	OFF
10	ON	OFF	OFF	ON	OFF	OFF
11	OFF	ON	OFF	ON	OFF	OFF
12	ON	ON	OFF	ON	OFF	OFF
13	OFF	OFF	ON	ON	OFF	OFF
14	ON	OFF	ON	ON	OFF	OFF
15	OFF	ON	ON	ON	OFF	OFF
16	ON	ON	ON	ON	OFF	OFF
17	OFF	OFF	OFF	OFF	ON	OFF
18	ON	OFF	OFF	OFF	ON	OFF
19	OFF	ON	OFF	OFF	ON	OFF
20	ON	ON	OFF	OFF	ON	OFF
21	OFF	OFF	ON	OFF	ON	OFF
22	ON	OFF	ON	OFF	ON	OFF
23	OFF	ON	ON	OFF	ON	OFF
24	ON	ON	ON	OFF	ON	OFF
25	OFF	OFF	OFF	ON	ON	OFF
26	ON	OFF	OFF	ON	ON	OFF
27	OFF	ON	OFF	ON	ON	OFF
28	ON	ON	OFF	ON	ON	OFF
29	OFF	OFF	ON	ON	ON	OFF
30	ON	OFF	ON	ON	ON	OFF
31	OFF	ON	ON	ON	ON	OFF
32	ON	ON	ON	ON	ON	OFF
33	OFF	OFF	OFF	OFF	OFF	ON
34	ON	OFF	OFF	OFF	OFF	ON
35	OFF	ON	OFF	OFF	OFF	ON
36	ON	ON	OFF	OFF	OFF	ON
37	OFF	OFF	ON	OFF	OFF	ON
38	ON	OFF	ON	OFF	OFF	ON
39	OFF	ON	ON	OFF	OFF	ON
40	ON	ON	ON	OFF	OFF	ON
41	OFF	OFF	OFF	ON	OFF	ON
42	ON	OFF	OFF	ON	OFF	ON

43	OFF	ON	OFF	ON	OFF	ON
44	ON	ON	OFF	ON	OFF	ON
45	OFF	OFF	ON	ON	OFF	ON
46	ON	OFF	ON	ON	OFF	ON
47	OFF	ON	ON	ON	OFF	ON
48	ON	ON	ON	ON	OFF	ON
49	OFF	OFF	OFF	OFF	ON	ON
50	ON	OFF	OFF	OFF	ON	ON
51	OFF	ON	OFF	OFF	ON	ON
52	ON	ON	OFF	OFF	ON	ON
53	OFF	OFF	ON	OFF	ON	ON
54	ON	OFF	ON	OFF	ON	ON
55	OFF	ON	ON	OFF	ON	ON
56	ON	ON	ON	OFF	ON	ON
57	OFF	OFF	OFF	ON	ON	ON
58	ON	OFF	OFF	ON	ON	ON
59	OFF	ON	OFF	ON	ON	ON
60	ON	ON	OFF	ON	ON	ON
61	OFF	OFF	ON	ON	ON	ON
62	ON	OFF	ON	ON	ON	ON
63	OFF	ON	ON	ON	ON	ON
64	ON	ON	ON	ON	ON	ON

- SW7 – SW8 setting

PM-4324 : For Baud Rate Setting

RS-485	CAN	SW 7	SW8
9600 bps	125k (Default) bps	OFF	OFF
19200 (Default) bps	250k bps	ON	OFF
38400 bps	500k bps	OFF	ON
115200 bps	1M bps	ON	ON

PM-4324 : Select the different wiring mode

(Please select the Software setting, if 1P2W-1CT or 1P3W-2CT is used)

Models	PM-4324/PM-4324-CPS/PM-4324-MTCP	
Wiring	SW 9	SW 10
Software setting	OFF	OFF
3P3W-2CT	ON	OFF
3P3W-3CT	OFF	ON
3P4W-3CT	ON	ON

2.8. Add the Bias Resistor on RS-485 Network for stable signal

The RS-485 master is required to provide the bias for PM-4324 series. Otherwise, the tM-SG4 or SG-785 should be added to provide the bias. All ICP DAS controllers and converters provide the bias.

2.9. Ethernet setting

- Ethernet default settings:

IP Address	192.168.255.1
Subnet mask	255.255.0.0
Gateway	192.168.0.1
Port	502

2.10. Specifications

Model	PM-4324	PM-4324-MTCP	PM-4324-CPS
AC Power Measurement			
Wiring	1P2W-1CT, 1P3W-2CT, 3P3W-2CT, 3P3W-3CT and 3P4W-3CT		
Measurement Voltage	10 ~ 500 V (CAT III)		
Measurement Current	CT Φ10 mm (60 A); CTΦ16 mm (100 A); CTΦ24 mm (200 A); CTΦ36m (300 A); CTΦ36m (400 A)		
Measurement Frequency	50-60 Hz		
W Accuracy	Better than 0.5% (PF:1)		
Starting Current	>0.03A (60A), >0.05A (100A), >0.09A(200A)		
Power Parameter Measurement	True RMS voltage (Vrms), True RMS current (Irms), Active Power (kW), Active Energy (kWh), Apparent Power (kVA), Apparent Energy (kVAh), Reactive Power (kVAR), Reactive Energy (kVARh), Power Factor (PF), Frequency(Hz)		
Data Update Rate	1 Second		
Communication			
RS-485	Protocol	Modbus-RTU	-
	Baud rate	9600,19200 (default), 38400, 115200; DIP Switch Selectable	-
	Data format	N,8,1 (default); N,8,2; E,8,1; E,8,2; O,8,1; O,8,2	-
	Isolation	3000 VDC	-
	Bias Resistor	No (Usually supplied by the RS-485 Master. Alternatively, add a tM-SG4 or SG-785)	-
Ethernet	Protocol		Modbus TCP (Ethernet Switch)
CANopen	Protocol		CANopen
	Baud rate		25 k (default), 250 k, 500 k, 1 M;
Alarm Output			
Power Relay	Form A (Normal Open) x 2; Relay Contact Voltage Range: 5 A @ 250 VAC (47 ~ 63Hz), 5 A @ 30 VDC		
Aux Power			
Input Range	+100 ~ +240 VAC		
Power Consumption	6 W		
Dimensions (W x L x H)	237 mm x 52 mm x 134 mm		
Environment			
Operating Temperature	-20 ~ +70 °C		
Storage Temperature	-25 ~ +80 °C		