

# I-7188XA Series User's Manual

## **Warranty**

All products manufactured by ICP DAS are under warranty regarding defective materials for a period of one year, beginning from the date of delivery to the original purchaser.

## **Warning**

ICP DAS assumes no liability for any damage resulting from the use of this product. ICP DAS reserves the right to change this manual at any time without notice. The information furnished by ICP DAS is believed to be accurate and reliable. However, no responsibility is assumed by ICP DAS for its use, not for any infringements of patents or other rights of third parties resulting from its use.

## **Copyright**

Copyright©2007 by ICP DAS Co., Ltd. All rights are reserved.

## **Trademark**

The names used for identification only may be registered trademarks of their respective companies.

---

## Table of Contents

<b>1. Introduction</b>	<b>4</b>
1.1 FEATURES	5
1.2 SPECIFICATIONS	6
1.3 Software and Document information	7
1.4 Hardware Information	9
1.4.1 Schematics and Dimensions of the I-7188XA(D)	9
1.4.2 Pin Assignment	10
1.4.3 Mounting the I-7188XA(D)	12
1.4.4 Block Diagram	13
1.4.5 Wiring Diagrams for Application	14
1.4.6 DI/DO wire connection	19
1.4.7 Mounting the I/O Expansion Bus	20
<b>2. Quick Start</b>	<b>21</b>
2.1 Software Installation	21
2.2 Connect the Download Cable to the Host PC	22
2.3 Downloading Programs to the I-7188XA(D)	24
2.4 MiniOS7 Upgrade	28
<b>3. Writing Your First Program</b>	<b>31</b>
3.1 Libraries	31
3.2 Compiler and Linker	32
3.3 The Detailed Steps for Programming	33
3.3.1 Download Turbo C++ version 1.01	33
3.3.2 Install Turbo C++ version 1.01	35
3.3.3 Set the environment variables of the system	38
3.3.4 Build and Execute the Program	40
3.4 Building project on 64-bit platform	48
<b>4. Operating Principles</b>	<b>49</b>
4.1 System Mapping	49
4.2 Debugging custom Programs using COM4	50
4.3 Using the Download Port as a COM Port	52
4.4 Functions and Demo Programs List	53
4.5 COM Port Comparison	56
4.6 Using the COM Ports	57
4.6.1 To print from the COM port	58
4.6.2 To Use COM1/COM2 for an RS-485 Application	59
4.6.3 To Send a Command to an I-7000 module	59
4.7 Using the Red LED and 7-SEG LED Display	63
4.8 Accessing the I-7188XA(D) Memory	64
4.8.1 Using Flash Memory	64
4.8.2 Using RTC and NVSRAM	65
4.8.3 Using EEPROM	66
4.9 Using the Watchdog Timer	68
4.10 Using the Timer Function	70
4.11 Using Digital Input and Digital output	71
4.12 Using the I/O Expansion Bus	73
4.12.1 Definition of an I/O Expansion Bus	73
4.12.2 I/O Expansion Boards	76
<b>5. Applications</b>	<b>77</b>

---

5.1 Embedded Controllers.....	77
5.2 Local Real Time Controller (RTC).....	78
5.3 Remote Local Controller.....	79
5.4 PLC I/O Expansion Application.....	80
5.5 Radio Modem Application.....	82
5.6 An Application Using 4 COM Ports (1).....	84
5.7 An Application Using 4 COM Ports (2).....	85
<b>Appendix A: What is MiniOS7 .....</b>	<b>86</b>
<b>Appendix B: MiniOS7 Utility and 7188XW .....</b>	<b>89</b>
MiniOS7 Utility .....	89
7188XW .....	91
<b>Appendix C: Comparison Table.....</b>	<b>100</b>
<b>Appendix D: Library Function List.....</b>	<b>101</b>
<b>Appendix E: Compiling and linking .....</b>	<b>138</b>
Using the TC Compiler .....	138
Using the BC++ Compiler .....	141
Using MSC Compiler .....	147
Using MSVC++ Compiler.....	149
Compiling on 64-bit platform like Windows 7 or Windows 8 / 8.1 .....	154
<b>Appendix F: Glossary .....</b>	<b>165</b>
<b>Appendix G: Revision History .....</b>	<b>166</b>

---

# 1.Introduction

The I-7188XA(D) is a series of expandable embedded controllers designed for industry applications and can be used to replace PC or PLC devices in harsh environments. The I-7188XA(D) also has support for an I/O expansion bus, which can be used to implement various I/O functions, such as D/I, D/O, A/D, D/A, UART, Flash memory, battery backup SRAM, AsicKey and other I/O functions. Most types of I/O function can be implemented using this bus. ICP DAS offers more than 10 types of I/O Expansion Board for the I-7188XA(D), which can be used to expand the features of the controller. Depending on the type of embedded firmware programs that are being developed, and which I/O Expansion Board, the I-7188XA(D) can be used as a single versatile controller.

## Package List

In addition to this manual, the shipping package includes the following items:

- One I-7188XA(D) module
- One download cable (CA0910)
- One companion CD containing software drivers and digital versions of the user manuals
- One copy of the release notes



**Note:** If any of these items are missing or damaged, please contact your local distributors for more information. We recommend that you save the shipping materials and cartons in case you want to ship the product in the future.

---

## 1.1 FEATURES

- AMD embedded CPU, Am188™ES, 40M or compatible
- Built-in RTC, NVRAM and EEPROM
- 4 Built-in COM ports: COM1, COM2, COM3 and COM4
- Isolation voltage on the RS-485 port of 3000V
- 64-bit internal hardware-unique serial number
- COM driver supports both interrupt and 1K QUEUE input/output buffer
- Support for I/O expansion bus interface (Only one expansion board can be added)
- Two Digital Input Channels
- Two Open-collector output Channels
- Built-in self-tuner ASIC controller on the RS-485 port
- Optional 5 digits 7 segment display
- Built-in MiniOS7 by ICP DAS
- Program download port: COM4

## 1.2 SPECIFICATIONS

<b>CPU module</b>	
CPU	Am188™ES, 40MHz or compatible
SRAM	512K bytes
Flash	512K bytes
EEPROM	2K bytes
NVRAM	31 bytes
RTC (Real Time Clock)	Yes
Hardware Serial Number	Yes
Build-in Watchdog Timer	Yes
<b>Communication Interface</b>	
COM 1	RS-232/RS-485 (Set using jumper JP6, default is RS-232)
COM 2	RS-485 (Isolation voltage 3000V)
COM 3	RS-232
COM 4	RS-232 (Program download port)
Ethernet Port	No
<b>Digital Input</b>	
Input Channels	2
Contact	Dry
On Voltage Level	Connect to GND
Off Voltage Level	Open.
<b>Digital Output</b>	
Output Channels	2
Output Type	Open-collector
Max Load Current	100mA
Load Voltage	+30V/DC Max.
<b>LED Display</b>	
1 LED as Power/Communication Indicator	
5 digits 7 segment display (for I-7188XAD only)	
<b>Dimensions</b>	
119mm x 72mm x 33mm	
<b>Operating Environment</b>	
Operating temperature	-25°C to +75°C
Storage Temperature	-30°C to +80°C
Humidity	10 to 90% RH(non-condensing)
<b>Power</b>	
Power requirements	10 to 30V/DC (non-regulated)
Power consumption	2.0W for I-7188XA 3.0W for I-7188XAD

---

## 1.3 Software and Document information

The location of all documents and software related to the I-7188XA(D) on the companion CD are shown in the following directory tree. The relevant file can quickly be located by referring to the tree.

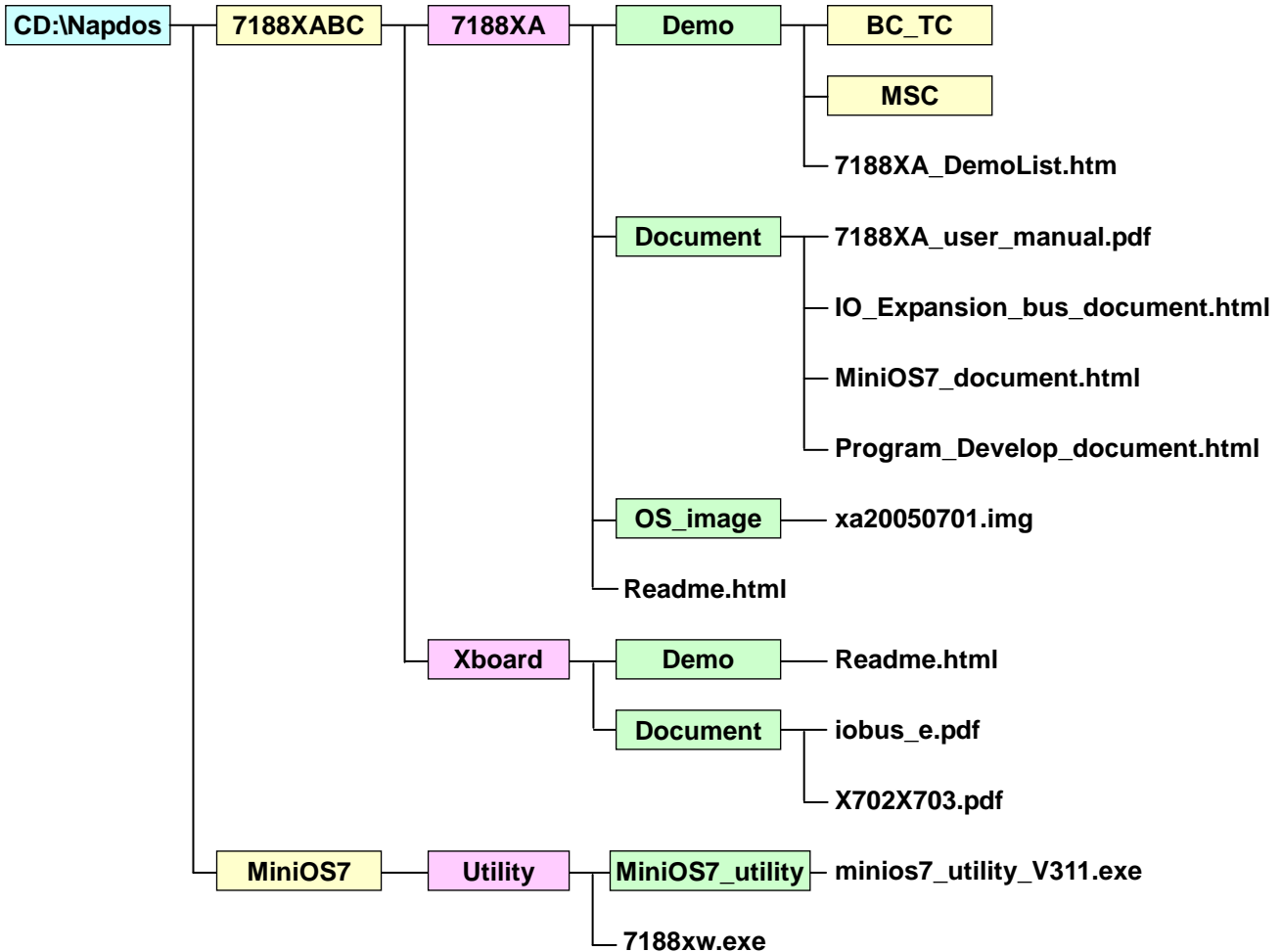

The documents and software listed above can also be obtained from the ICP DAS website: <http://ftp.icpdas.com/pub/cd/8000cd/napdos>. The folder location of all documents and software on the website is identical to the companion CD.

The **iobus\_e.pdf** file that is provided in the CD:\Napdos\7188XABC\Xboard\Document\ folder and the “**I/O Expansion Bus for 7188X/7188E User’s Manual**” contain the same content, so the user can refer to either document for more details related to the I-7188XA(D) I/O expansion bus.

---

Before continuing, it is recommended that you read the **Readme.html**, which can be found in the **CD:\Napdos\7188XABC\7188XA\**. The latest information available prior to shipping will be contained in this file.



# 1.4 Hardware Information

## 1.4.1 Schematics and Dimensions of the I-7188XA(D)

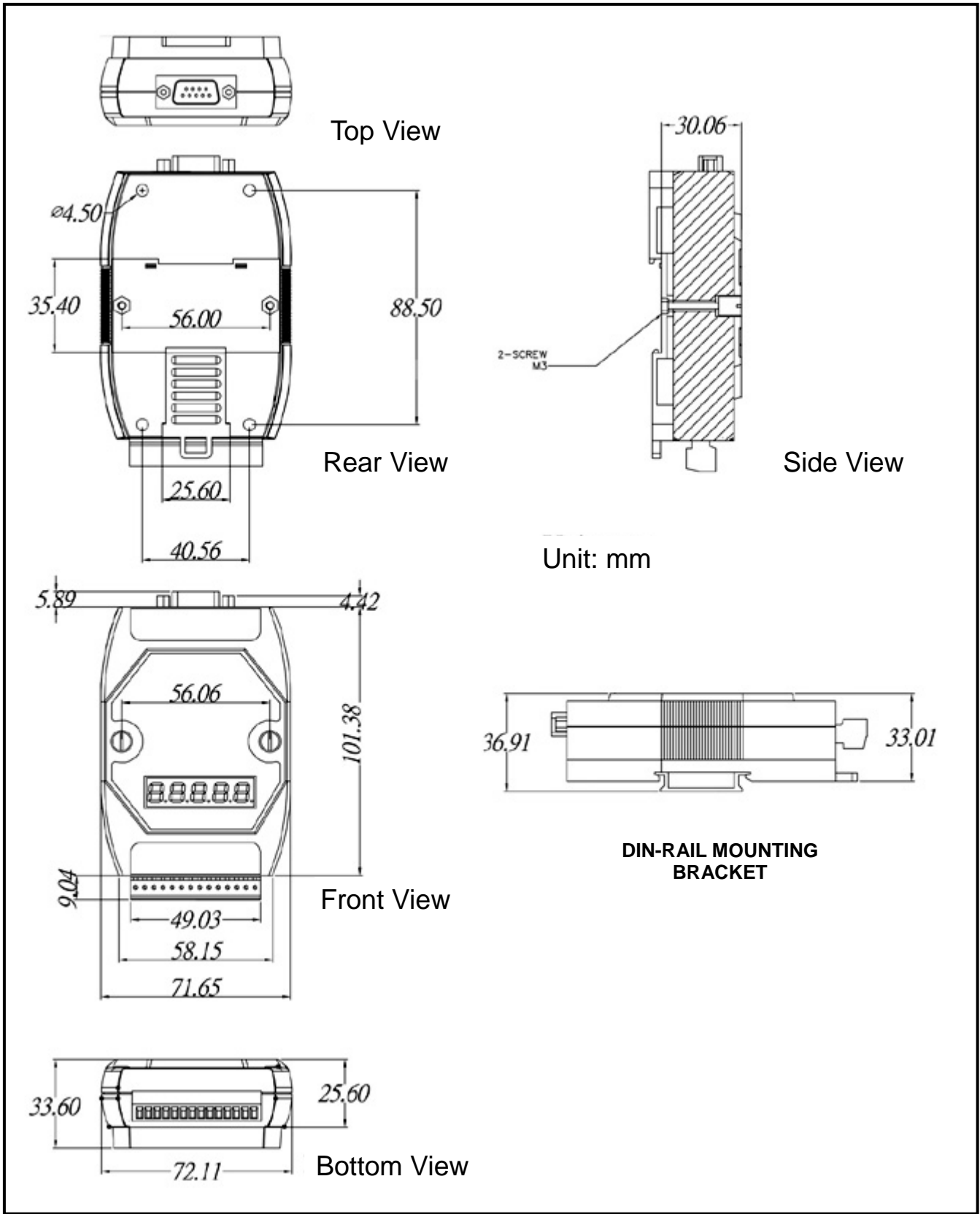

## 1.4.2 Pin Assignment

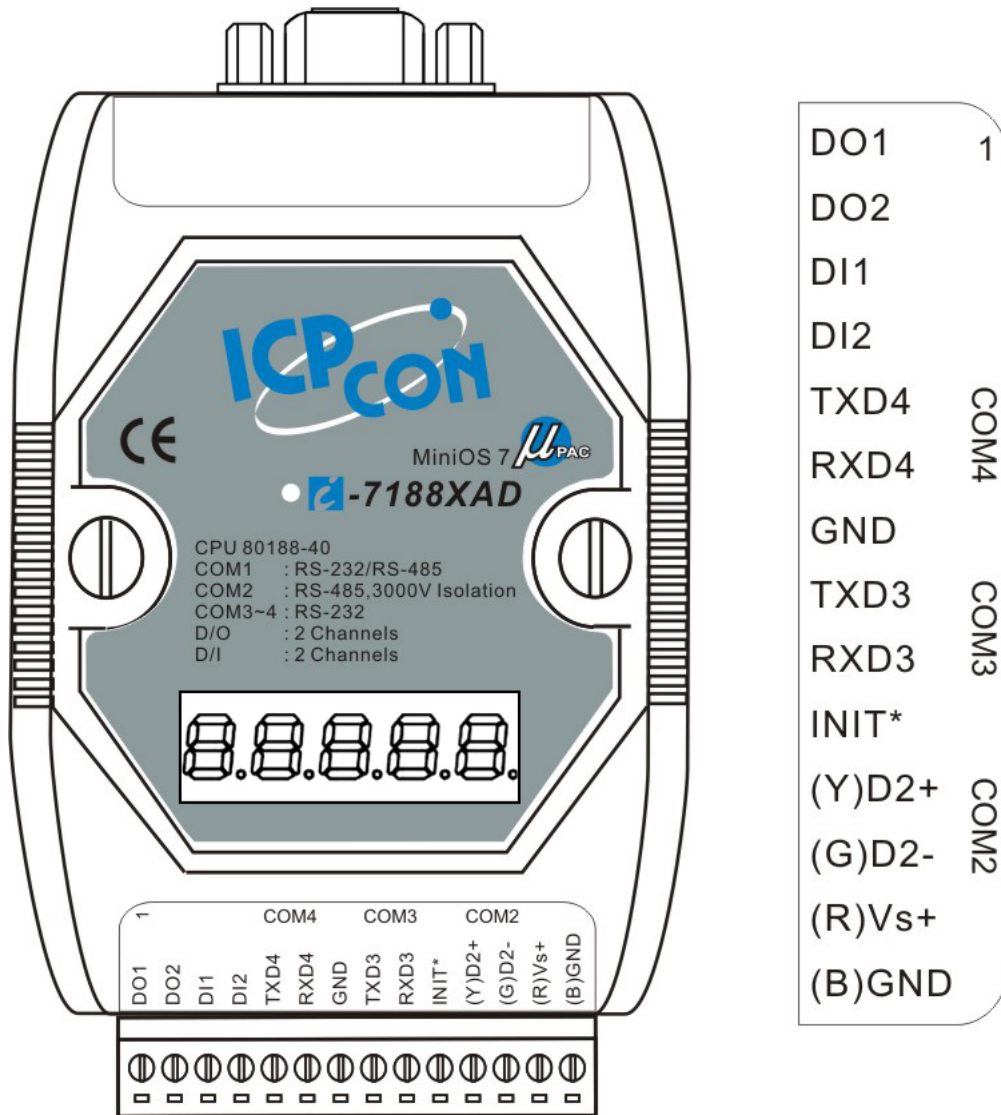

The pin assignment of 14-pin screw terminal block is as follows:

Pin	Name	Description
1	DO1	Digital output, 100mA, 30V Max.
2	DO2	Digital output, 100mA, 30V Max.
3	DI1	Digital input, 3.5V ~ 30V
4	DI2	Digital input, 3.5V ~ 30V
5	TXD4	TXD pin for COM4 (RS-232)
6	RXD4	RXD pin for COM4 (RS-232)
7	GND	GND pin for COM3 and COM4
8	TXD3	TXD pin for COM3 (RS-232)
9	RXD3	RXD pin for COM3 (RS-232)

10	INIT*	Initial pin
11	D2+	DATA+ pin for COM2 (RS-485)
12	D2-	DATA- pin for COM2 (RS-485)
13	+VS	V+ of power supply (+10 to +30V/DC, unregulated)
14	GND	GND for the power supply

**Note:** COM3 and COM4 share the same GND pin (pin 7).

The pin assignment for the COM1 connector (DB-9 Male) is as below:

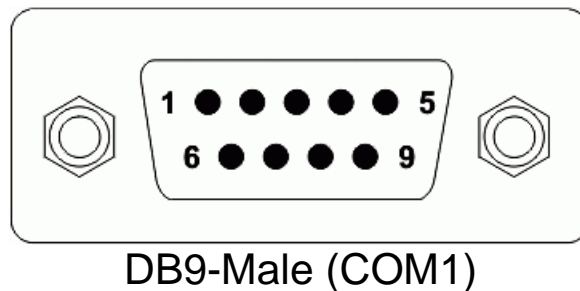

Pin	Name	Description
1	DCD	Data Carrier Detect (RS-232)
2	RXD	Receive Data (Use JP6 to select RS-232)
	D1+	DATA+ for RS-485 (Use JP6 to select RS-485)
3	TXD	Transmit Data (Use JP6 to select RS-232)
	D1-	DATA- for RS-485 (Use JP6 to select RS-485)
4	DTR	Data Terminal Ready (RS-232)
5	GND	Signal ground for RS-232
6	DSR	Data Set Ready (RS-232)
7	RTS	Request To Send (RS-232)
8	CTS	Clear To Send (RS-232)
9	RI	Ring Indicator (RS-232)

**Note:** COM1 can be used as either an RS-232 or RS-485 port and is selected using jumper JP6. Refer to Section 1.4.5 for more details regarding JP6 settings. If JP6 is set to RS-232, the COM1 connector is the same as the DB-9 RS-232 connector of the Host PC. If JP6 is set to RS-485, COM1 can drive I-7000 series modules directly. For wiring connection details, please refer to Section 1.4.5.

---

### 1.4.3 Mounting the I-7188XA(D)

#### 1. Din-Rail Mounting

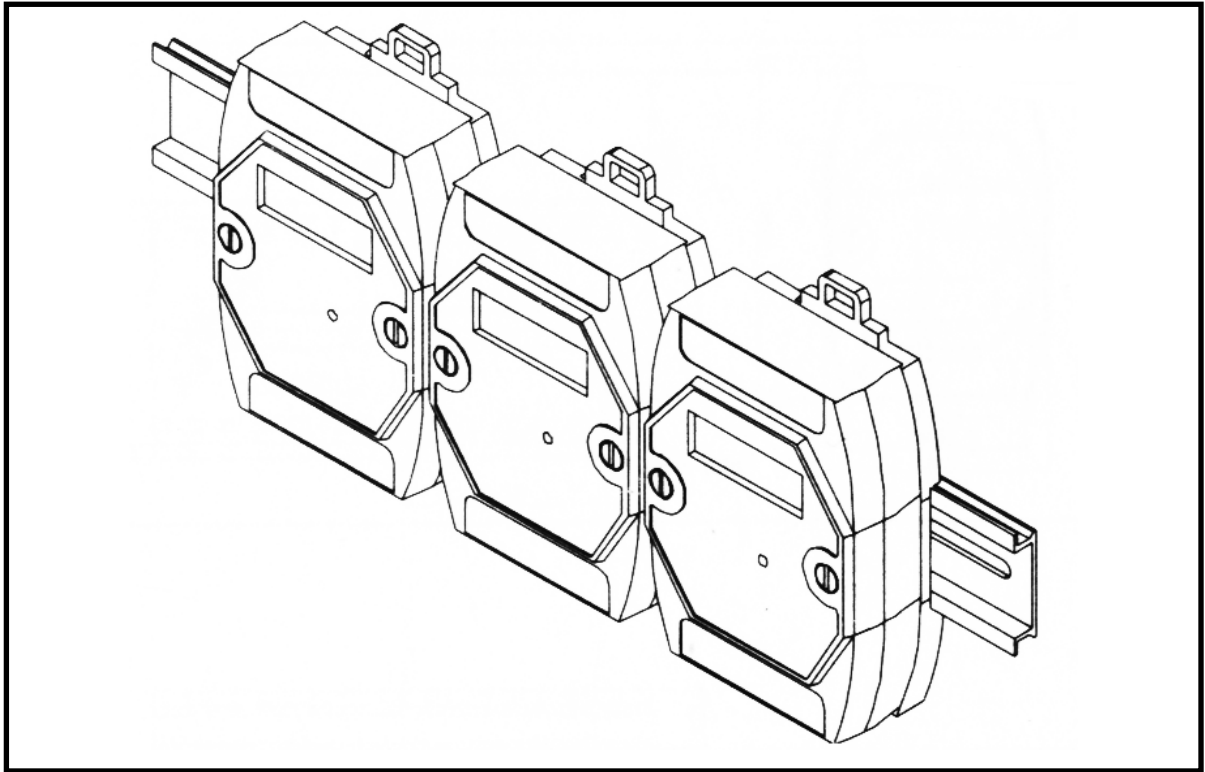

#### 2. Stack Mounting

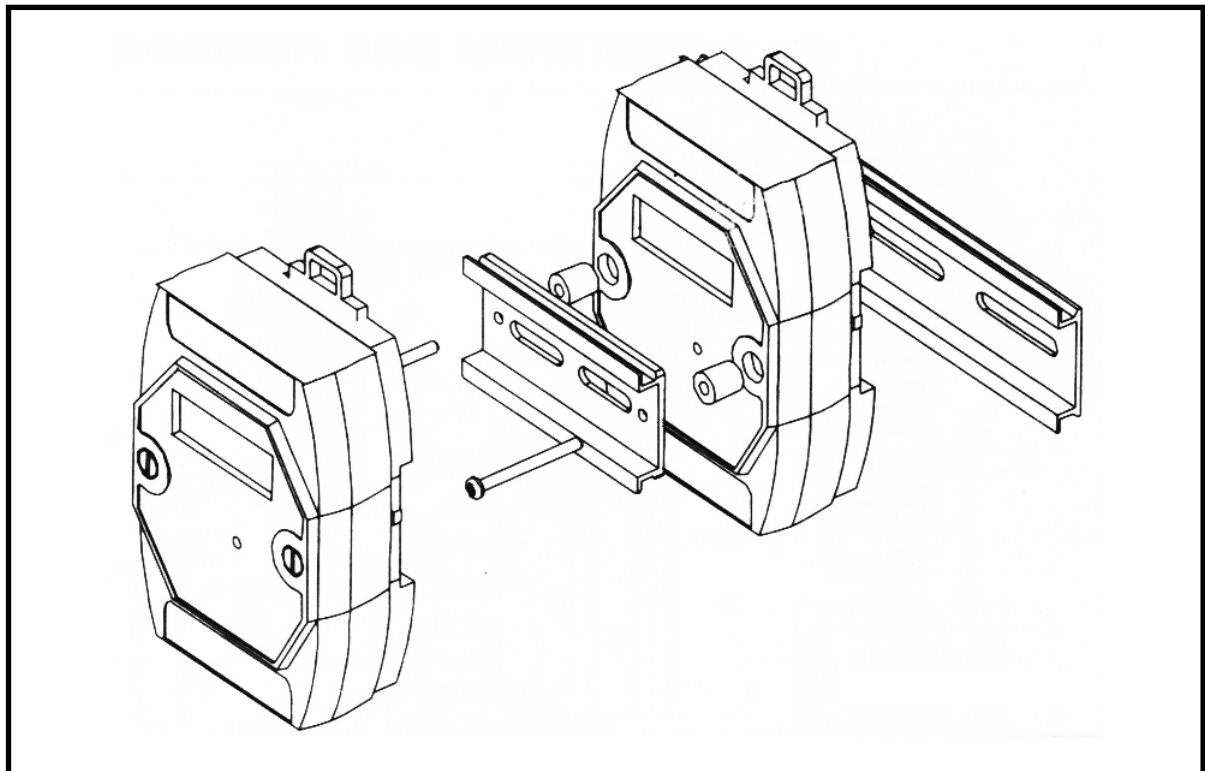

## 1.4.4 Block Diagram

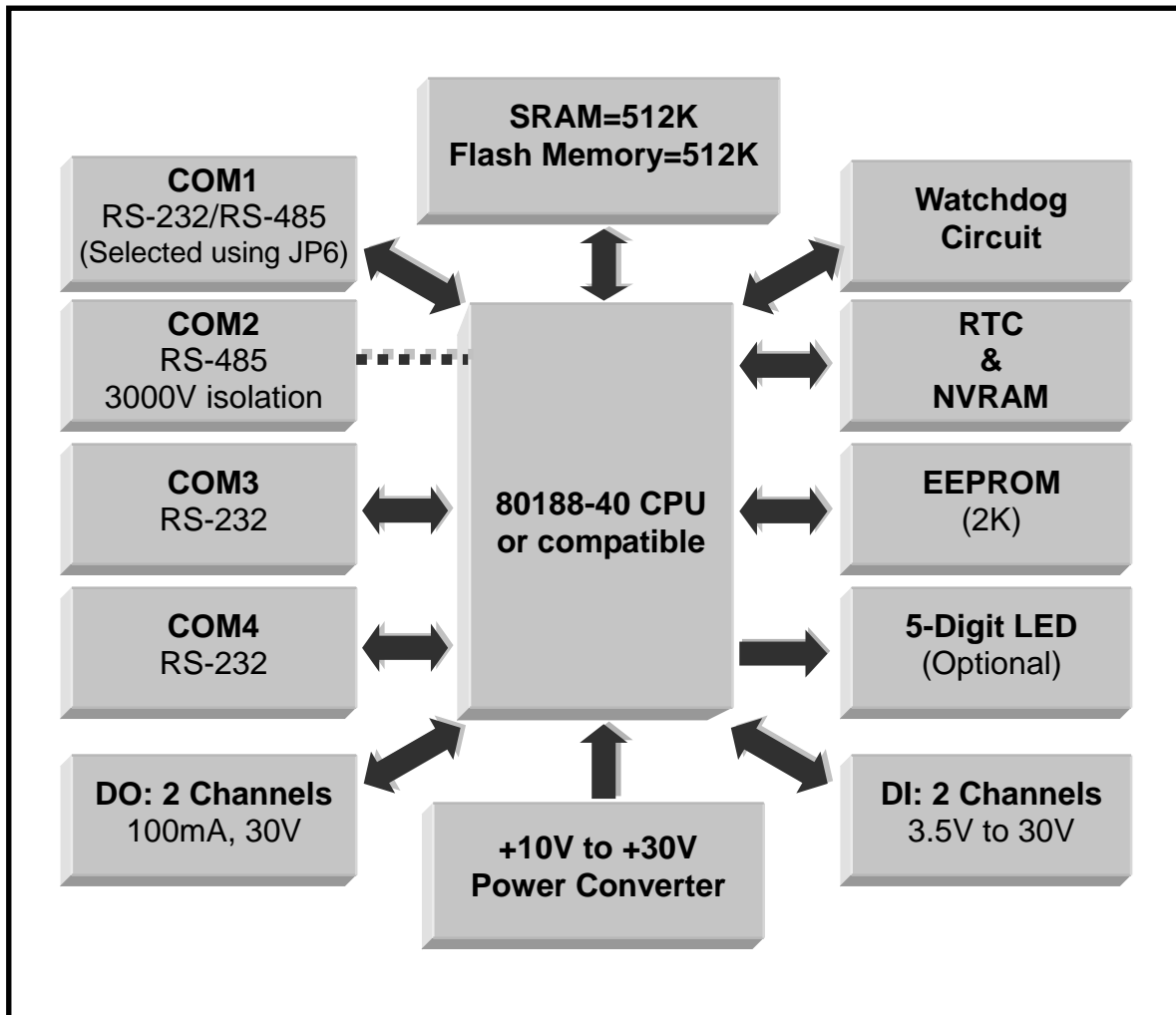

## 1.4.5 Wiring Diagrams for Application

### Program download

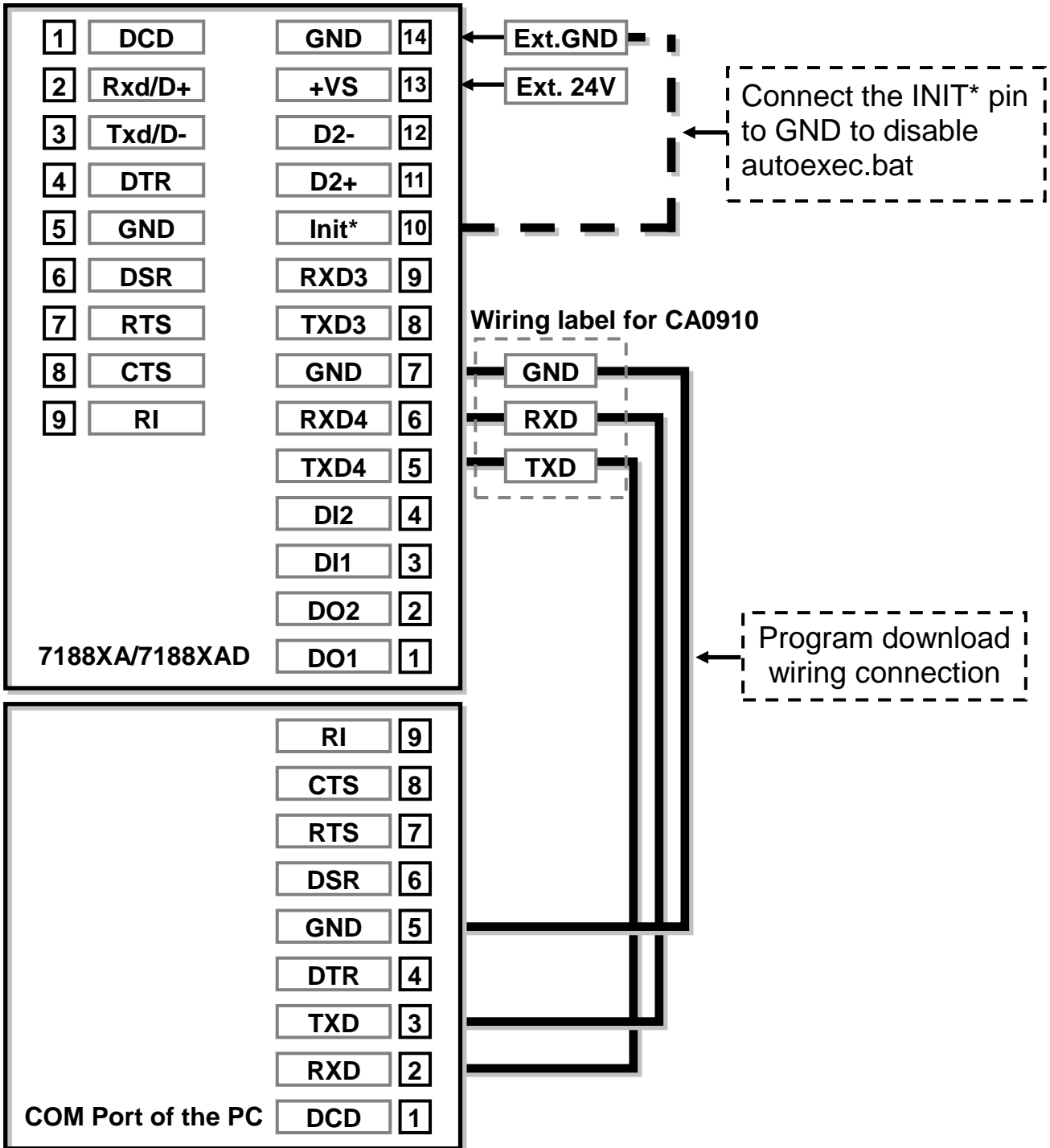

**Note:** There are 3 wires in the download cable:

- Connect wire-1, labelled RX, to pin-6 of the I-7188XA(D)
- Connect wire-2, labelled TX, to pin-5 of the I-7188XA(D)
- Connect wire-3, labelled GND, to pin-7 of the I-7188XA(D)
- Connect the DB-9 of the download cable to the PC COM1/2/3/4 Port

---

## Using a 3-wire RS-232 Port

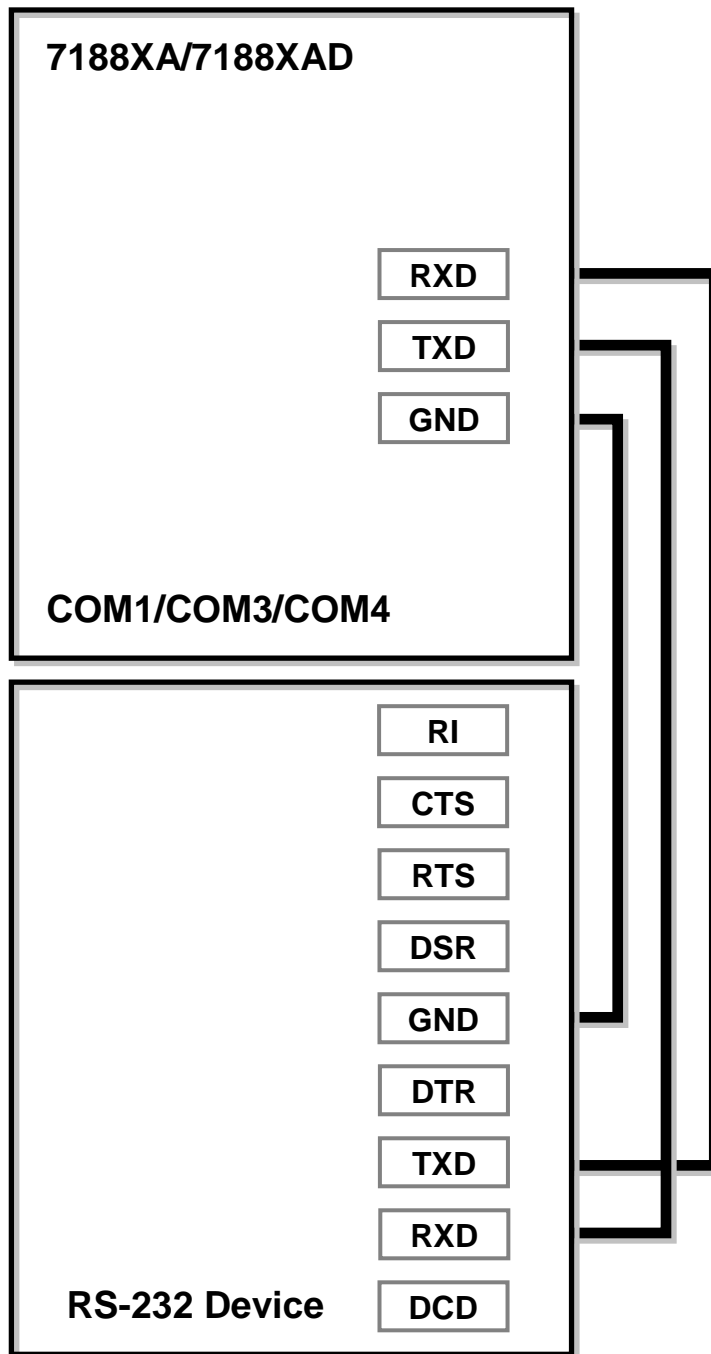

**Note:** There are 3 wires as follows:

- Connect the RXD to the TXD of the RS-232 device
- Connect the TXD to the RXD of the RS-232 device
- Connect the GND to the GND of the RS-232 device

---

## Using a 5-wire RS-232 Port

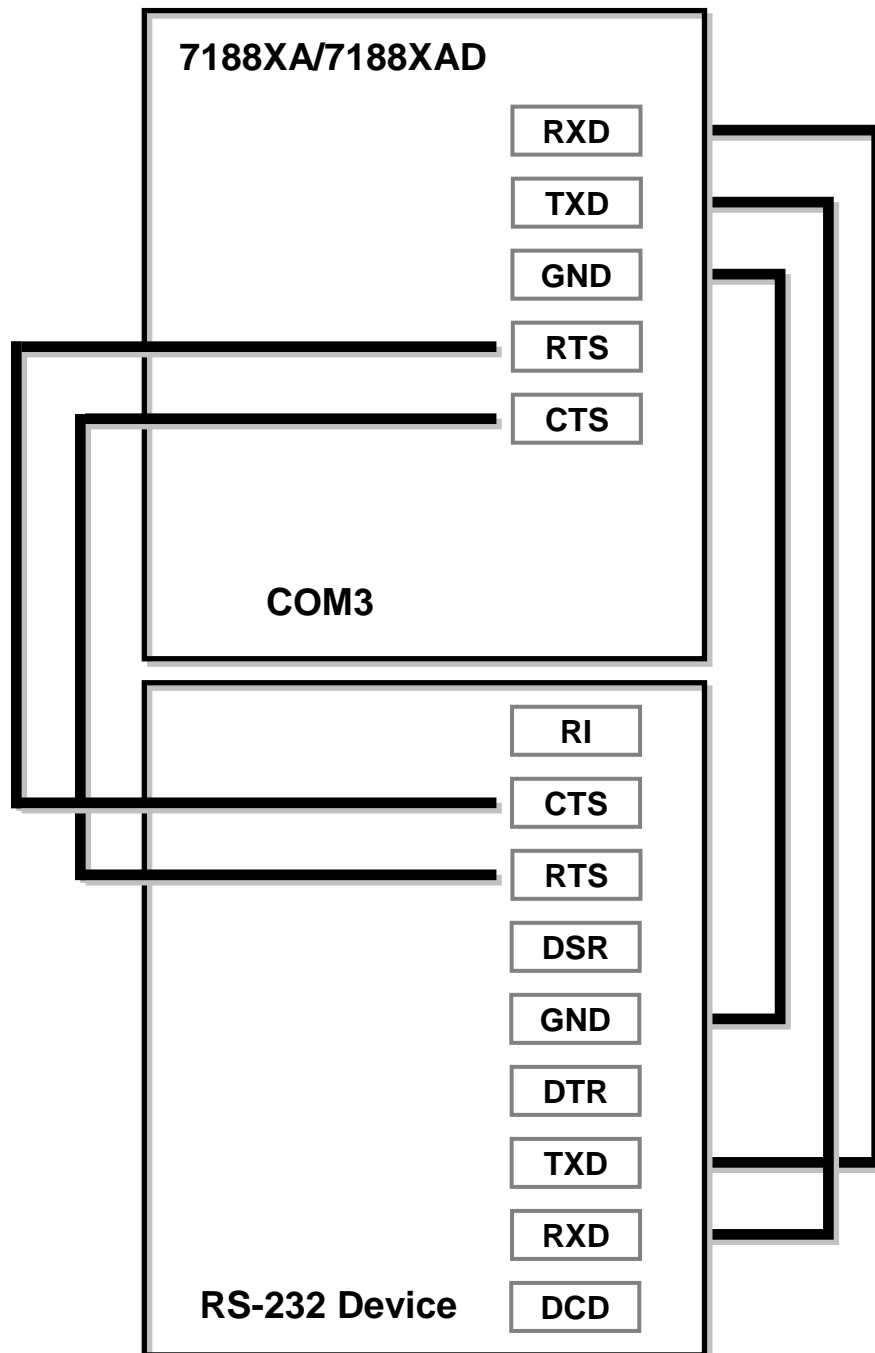

**Note:** There are 5 wires as follows:

- Connect the RXD to the TXD of the RS-232 device
- Connect the TXD to the RXD of the RS-232 device
- Connect the RTS to the CTS of the RS-232 device
- Connect the CTS to the RTS of the RS-232 device
- Connect the GND to the GND of the RS-232 device



## Using a 9-wire RS-232 Port

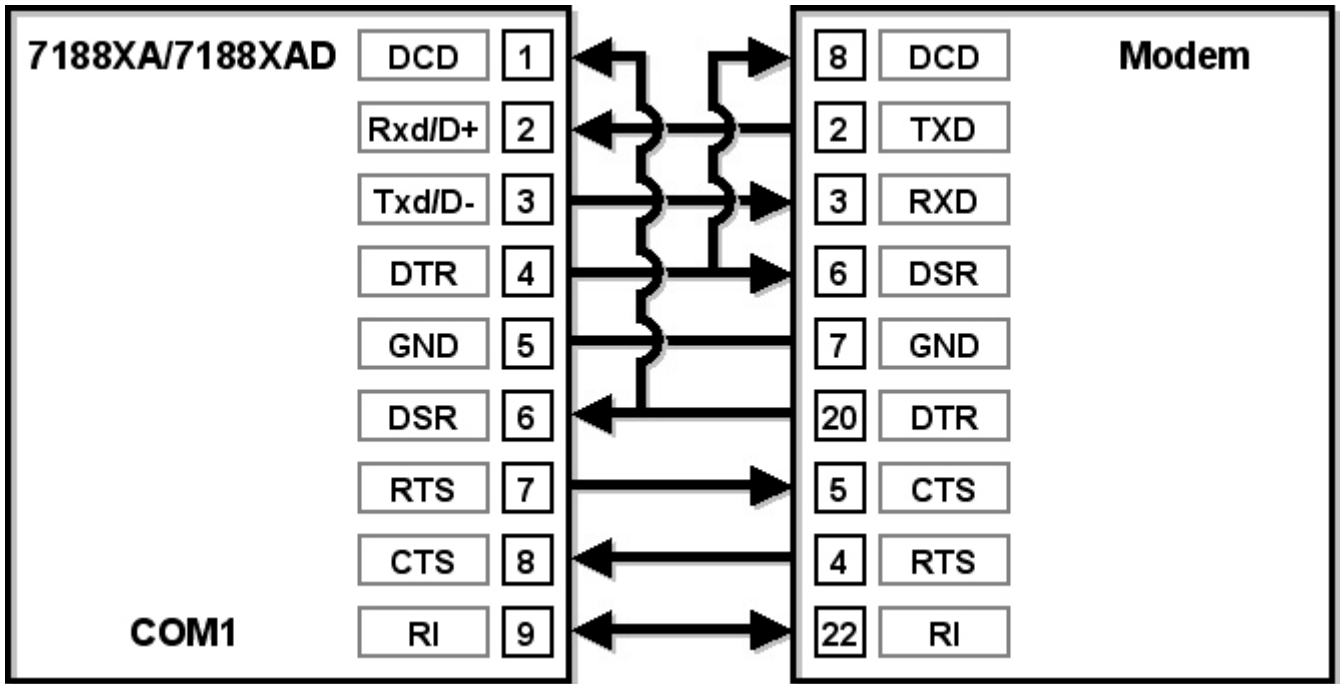

**Note:** The COM1 pin assignment of the I-7188XA(D) is the same as the Host PC. The settings for JP6 on the I-7188XA(D) is as follows:

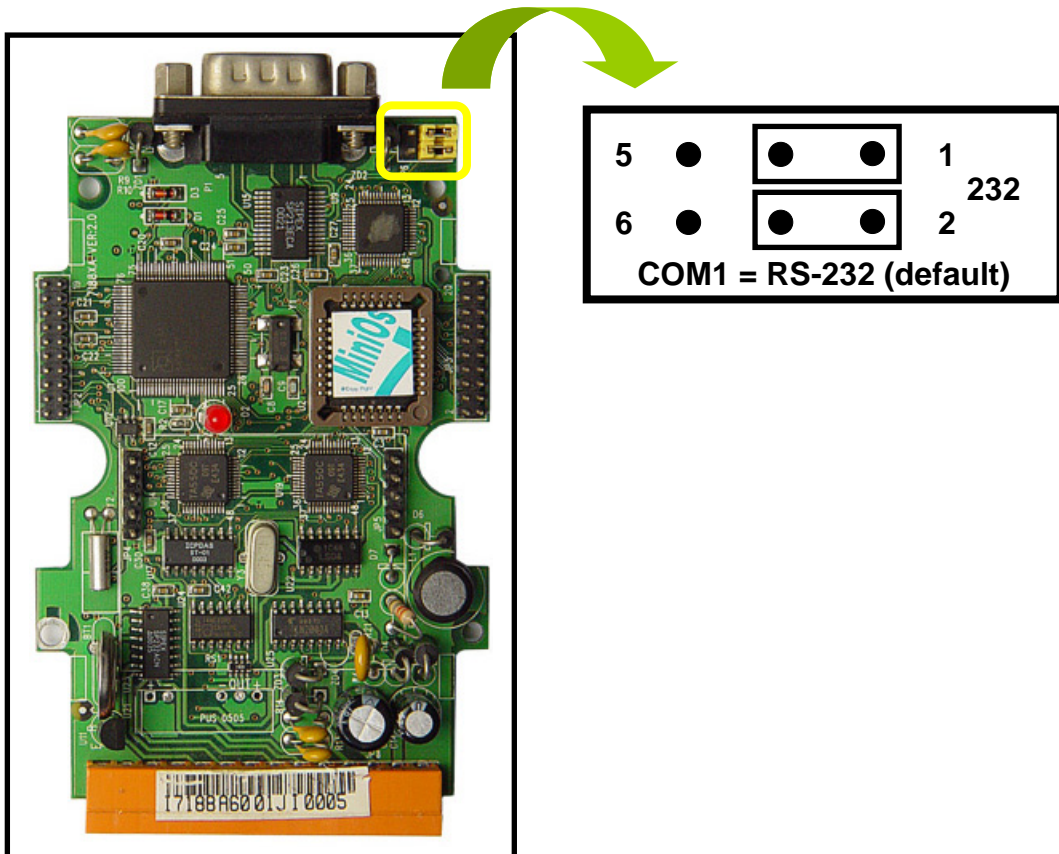

## Using the RS-485 Port

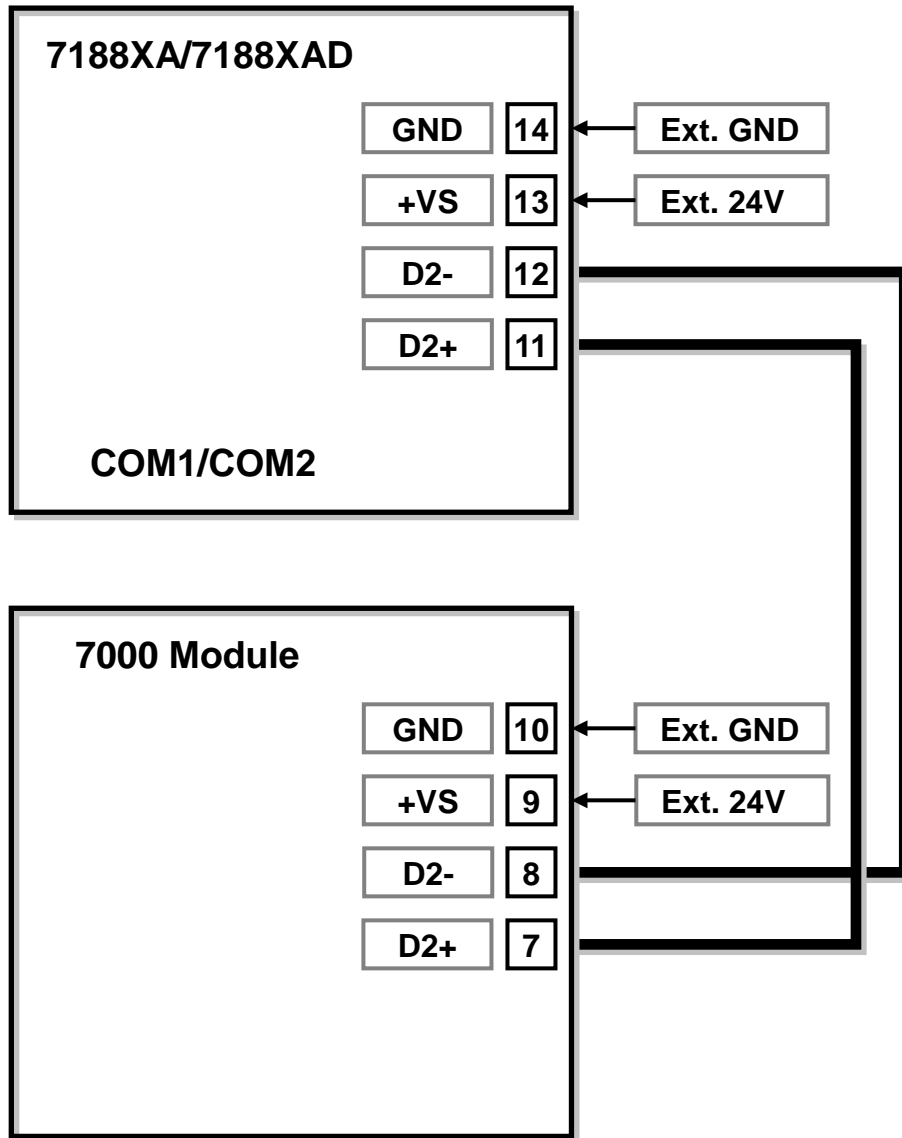

**Note:** The RS-485 interface can directly drive up to 256 I-7000 series modules without the need for a repeater. When using COM1 as an RS-485 COM Port, the settings for JP6 on the I-7188XA(D) is as follows:

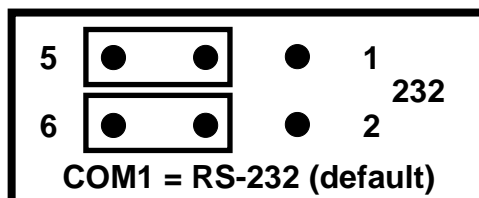

## 1.4.6 DI/DO wire connection

### Digital Input Wire Connection

Input Type	ON State DI value as 0	OFF State DI value as 1
Relay Contact		
TTL/CMOS Logic		
Open Collector		

### Digital Output Wire Connection

Input Type	ON State DO value as 1	OFF State DO value as 0
Drive Relay		
Resistance Load		

## 1.4.7 Mounting the I/O Expansion Bus

Before mounting:

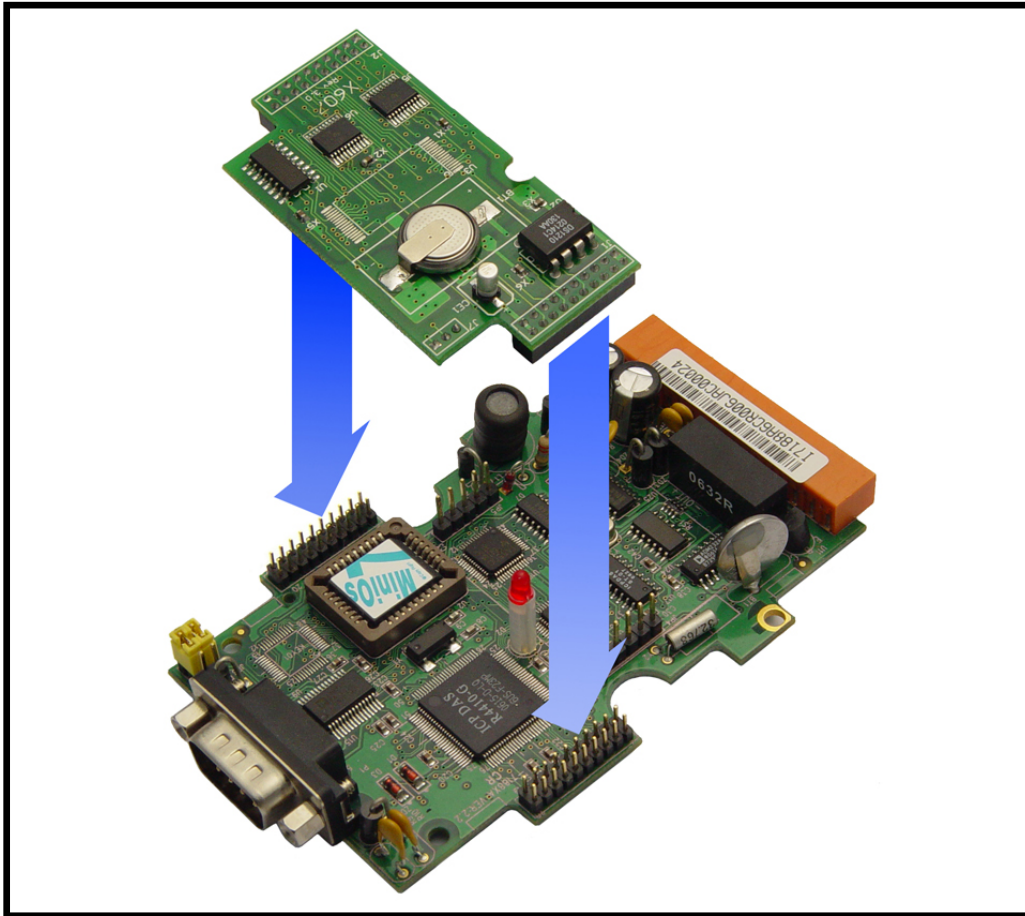

After mounting:

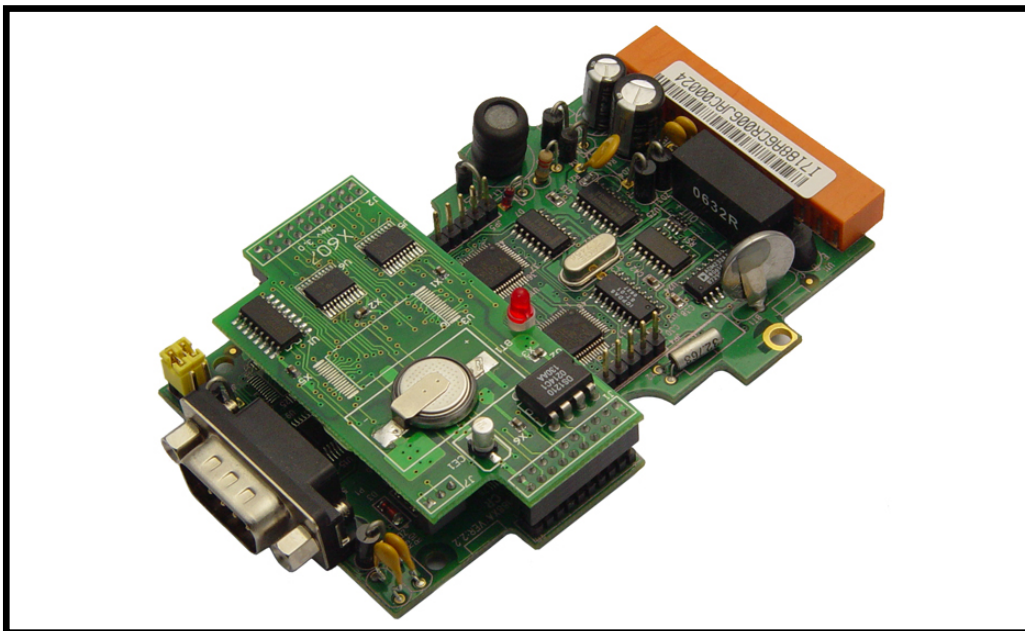

---

## 2. Quick Start

### 2.1 Software Installation

Step 1: Insert the companion CD into the CD drive.

Step 2: Copy the 7188XA folder from **CD:\Napdos\7188XABC\** to the Hard Drive of the Host PC.

Step 3: Install the MiniOS7 Utility.

Locate and execute the **minios7\_utility\_v311.exe** file from CD:\NAPDOS\MINIOS7\UTILITY\MiniOS7\_utility\ folder or [http://ftp.icpdas.com/pub/cd/8000cd/napdos/minios7/utility/minios7\\_utility/](http://ftp.icpdas.com/pub/cd/8000cd/napdos/minios7/utility/minios7_utility/)

Step 4: Copy the **7188xw.exe** file from the CD:\Napdos\MiniOS7\utility\ folder to the PATH directory, for example **C:\Windows\**.

After all the software is copied to the Host PC, the content of 7188XA folder should be as follows:

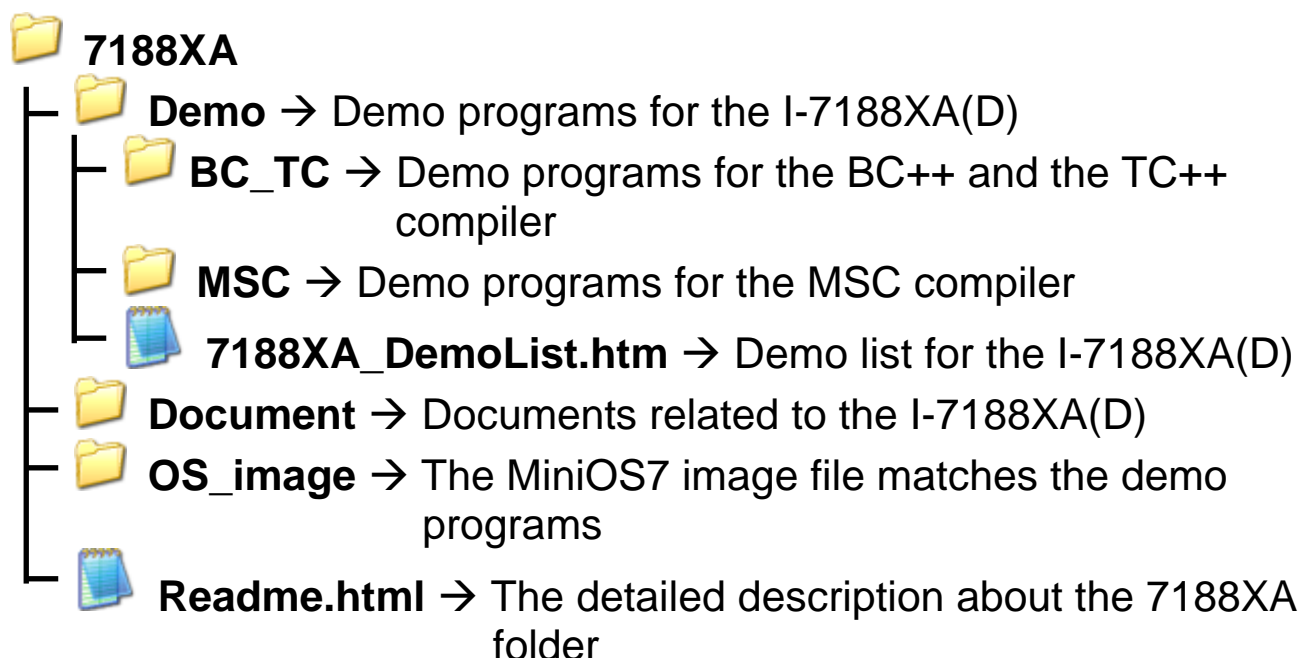

**Note:** The 7188xw.exe file is used as a bridge between the I-7188XA(D) and the Host PC. Therefore, the 7188xw.exe file must be copied to the “C:\Windows\” folder to allow it to be executed from any location.

## 2.2 Connect the Download Cable to the Host PC

Step 1: Connect the CA0910 download cable between COM4 of the I-7188XA(D) and the COM Port of the Host PC, as shown in the diagram below.

Step 2: Apply power (Vs+, GND) to the I-7188XA(D). Vs+ can be in a range from +10V to +30V DC.

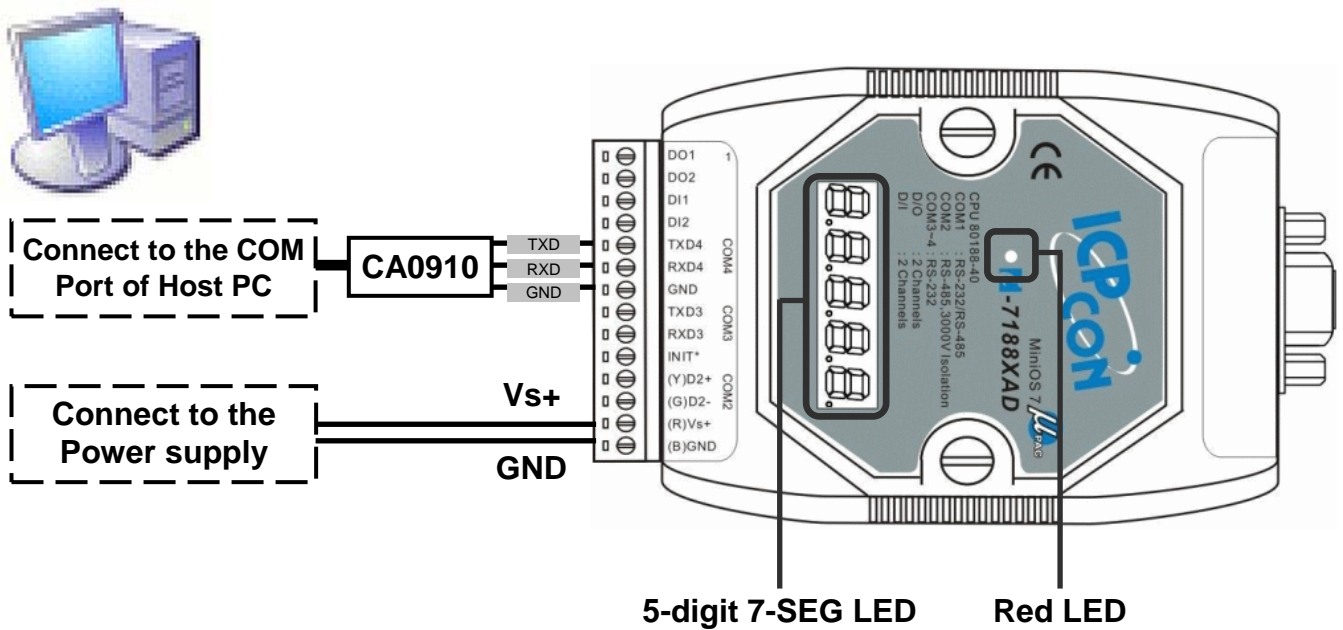

Step 3: After applying the power, the 5-digits of the 7-SEG LED will continuously show as follows.

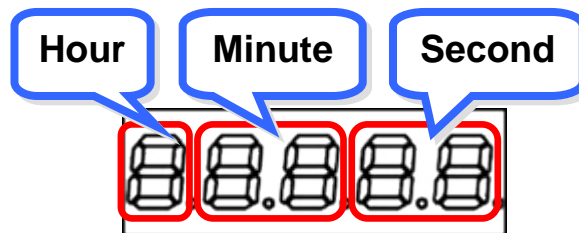

If the non-display version of module is being used, please continue to the next step.

Step 4: Check that the red LED continuously blinks four times and wait for one second to next cycle. The diagram show as follows:

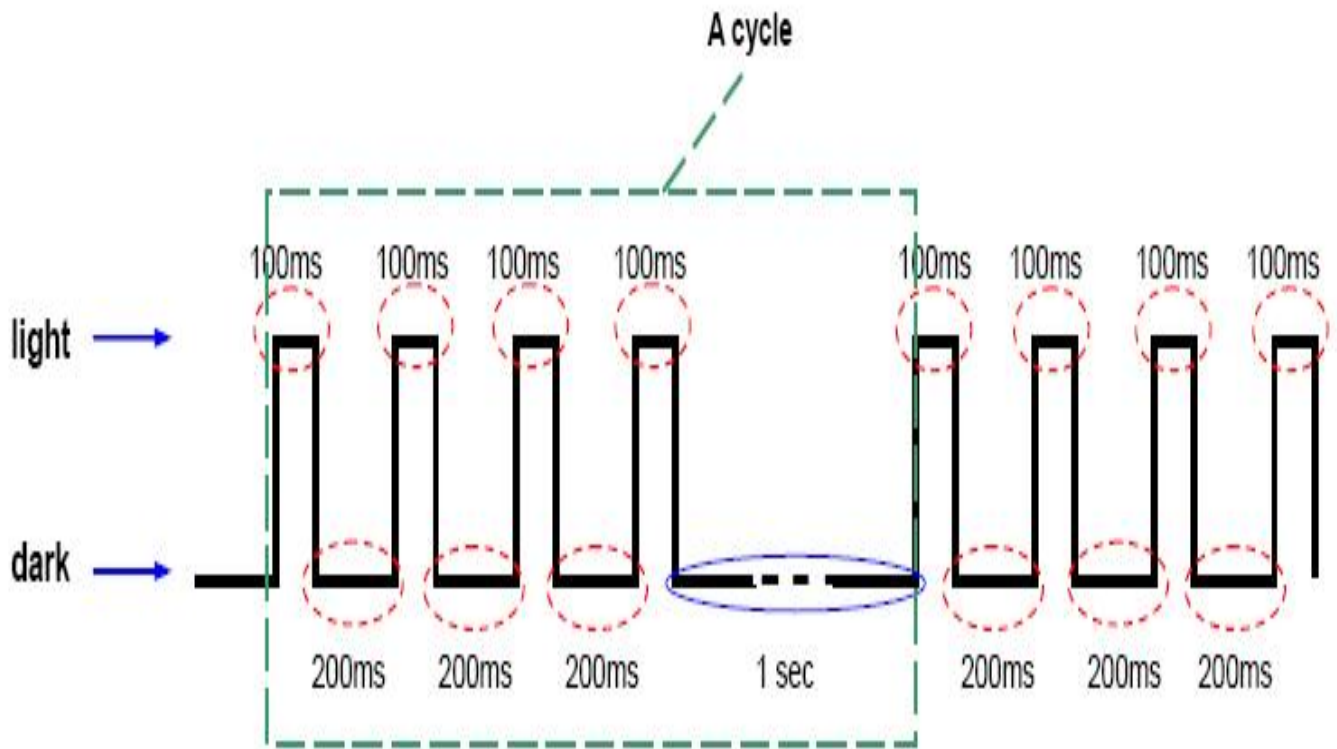

**Note:** Only the display version of the module will include a 5-digit 7-SEG LED.



---

## 2.3 Downloading Programs to the I-7188XA(D)

Before using the MiniOS7 Utility, ensure that the download cable is connected from the Host PC to the I-7188XA(D) and ensure that no other programs are running on the I-7188XA(D). For details of how to connect between the I-7188XA(D) and COM1 on the Host PC, refer to the wiring diagram in the Sec.1.4.5---Program download.

**Note:** Instead of using the MiniOS7 Utility to download programs to the I-7188XA(D), the 7188xw.exe file can also be used. Refer to **Appendix B: MiniOS7 Utility and 7188XW** for details of the program download procedure for 7188xw.exe.

The program download procedure is as follows (Refer to Sec2.1 to install MiniOS7 Utility Ver 3.11):

Step 1: From the Windows START menu, go to Programs/ICPDAS/MiniOS7 Utility Ver 3.11/and locate the **MiniOS7 Utility Ver 3.11**.

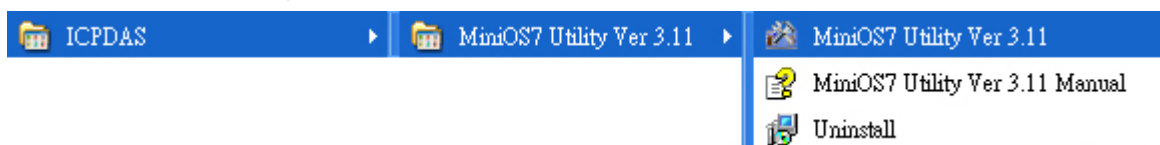

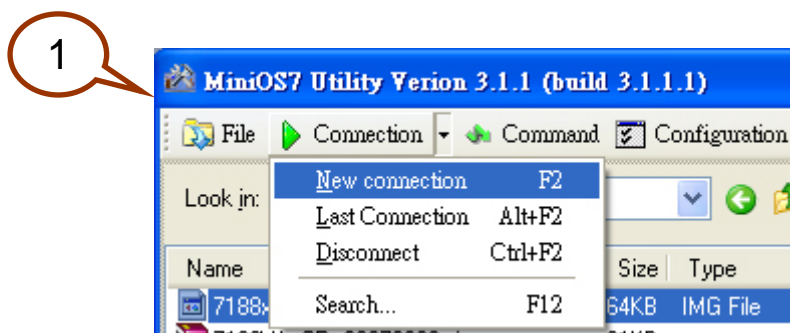

Step 2: Press  and Select "New connection". Choose the right COM port and set other parameters. Click **OK** button and the utility will search module automatically.



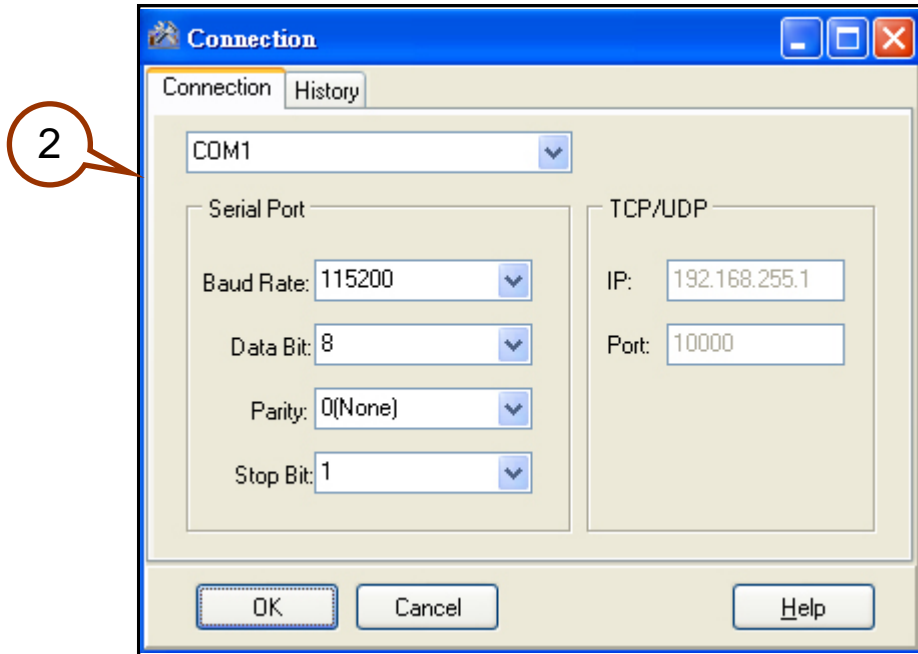

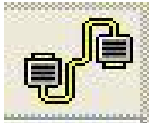

Step 3: See if the MiniOS7 Utility connects with I-7188XA. The connected icon is . The disconnected icon is .

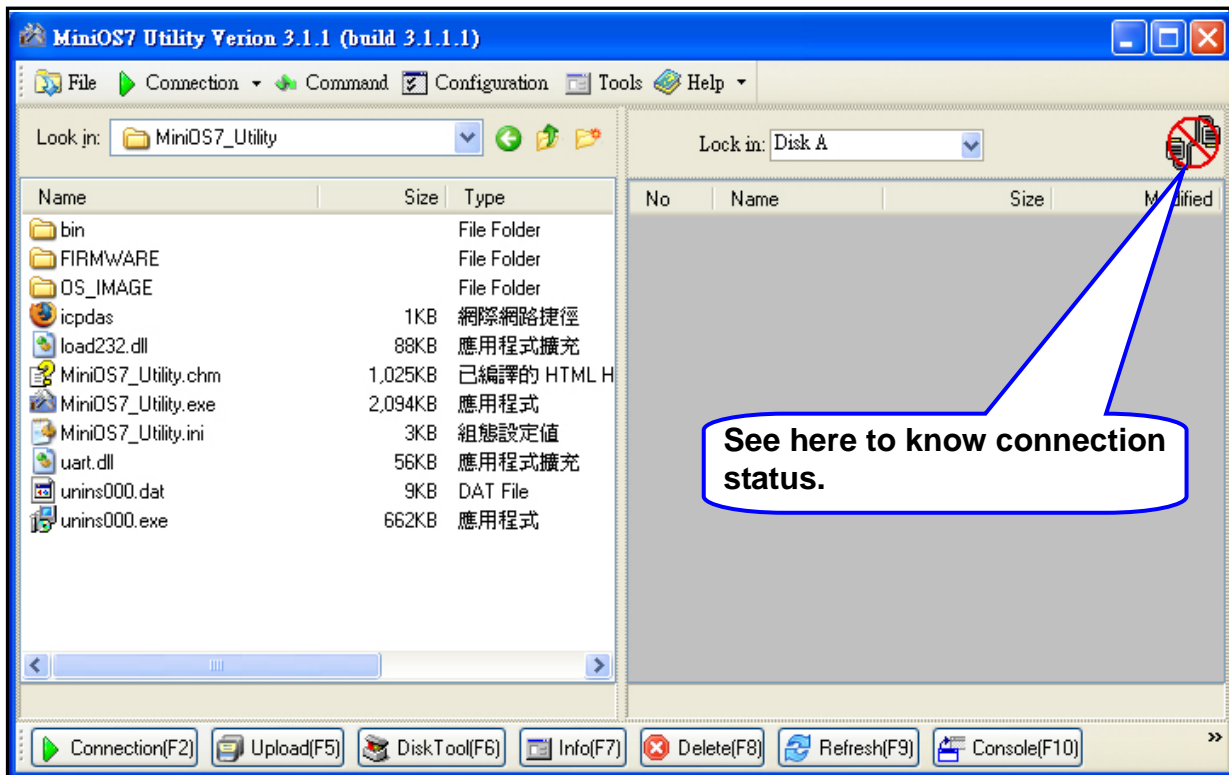

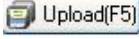
Step 4: Select the file to load from left side and click  to load file into module or draw the file to the right side.

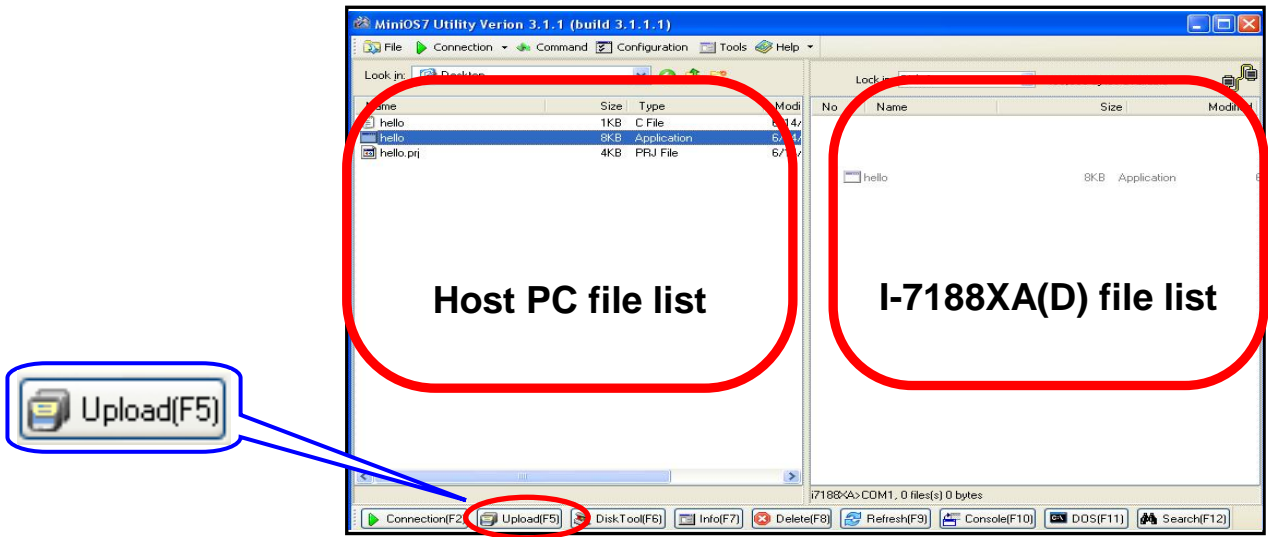

Step 5: Select the file and then press the right mouse button. Choose the **Run** and press to execute the program.

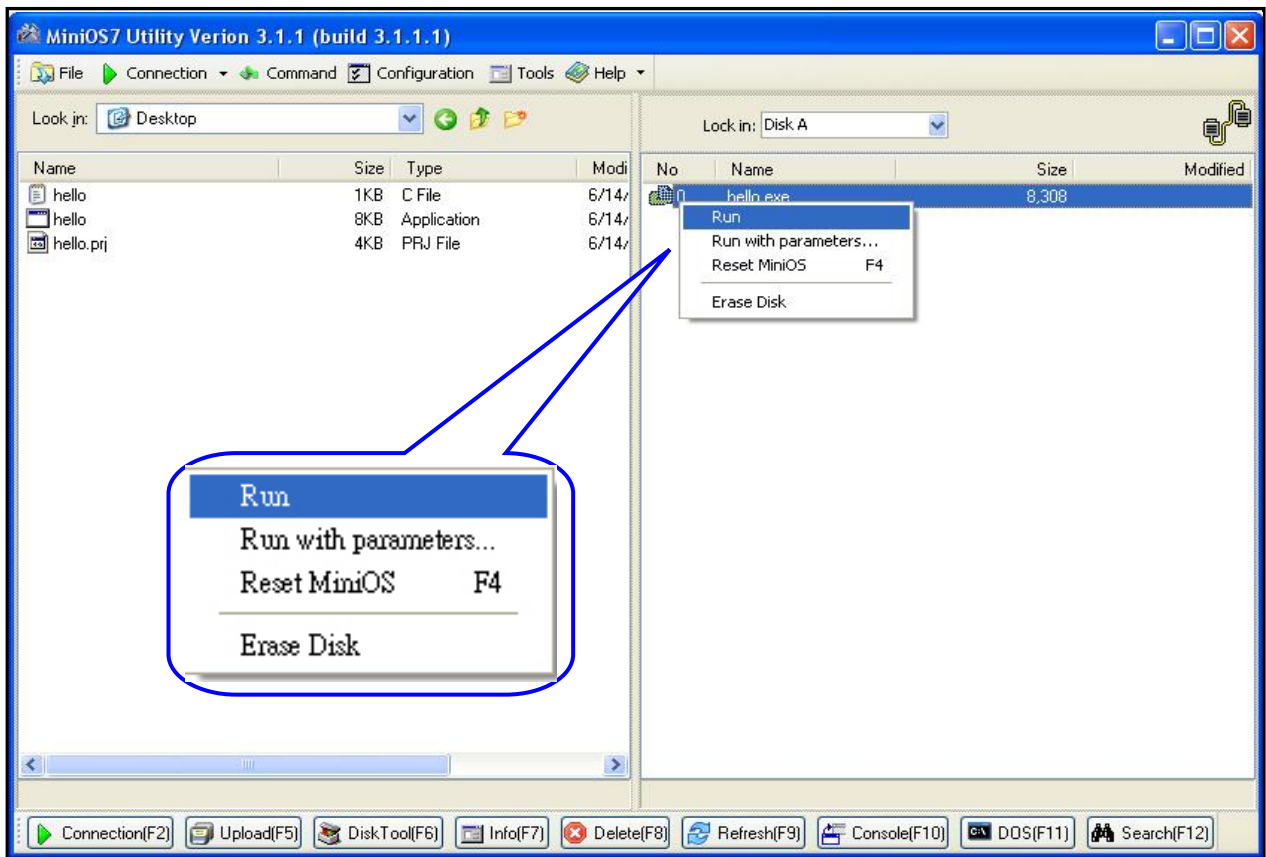

Step 6: The result of the program will be shown in 7188xw window.

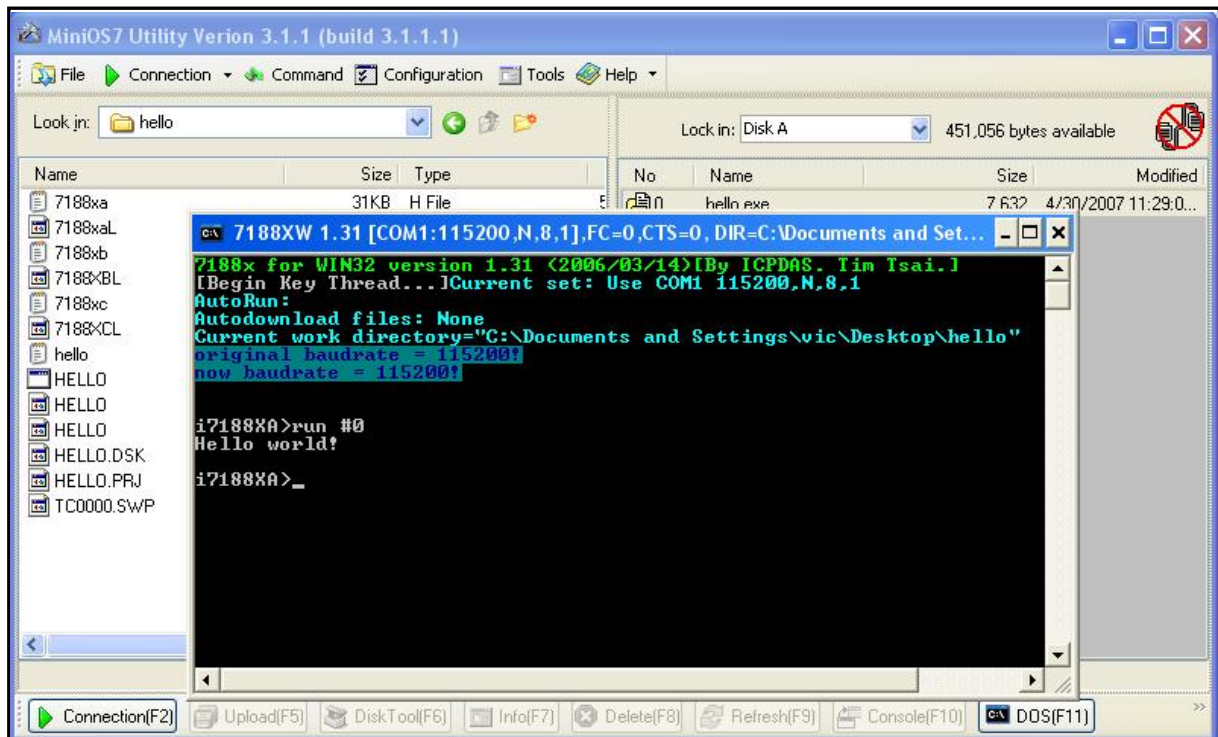

NOTE: The 7188xw window has to be closed and then the download operation (Step 4) could be done.

The content of the Hello.c file is as follows:

```
#include "7188xa.h" /* Include the headers to use 7188xa.lib  
functions */  
void main(void)  
{  
    InitLib(); /* Initiate the 7188xa library */  
    Print("Hello world!\r\n"); /* Print the message on the screen */  
}
```



Step 3: It will take about 10 seconds for the upgrade to finish. If the MiniOS7 was updated successfully, a **Confirm** action dialog box will appear.

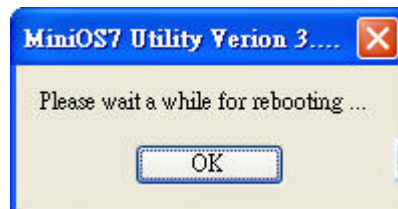
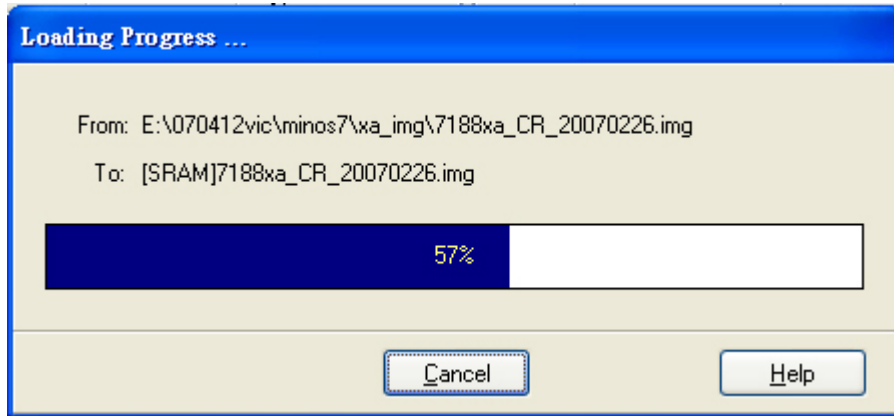

Step 4: Press  button and see the "Build" item to check the version number of the MiniOS7. The diagram is as follow:

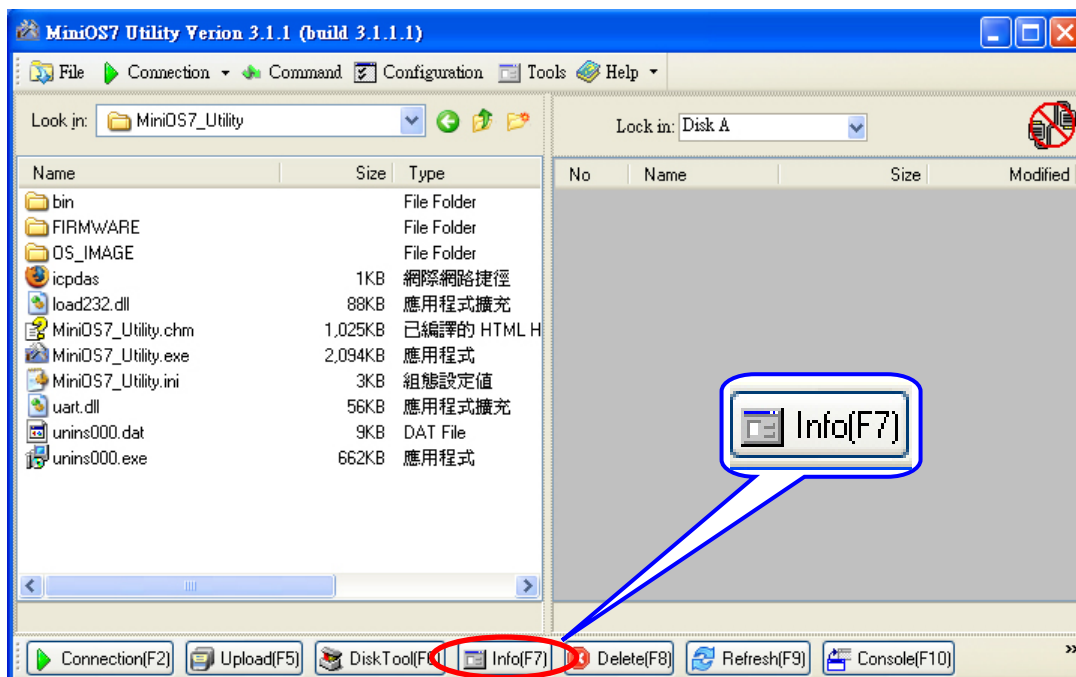

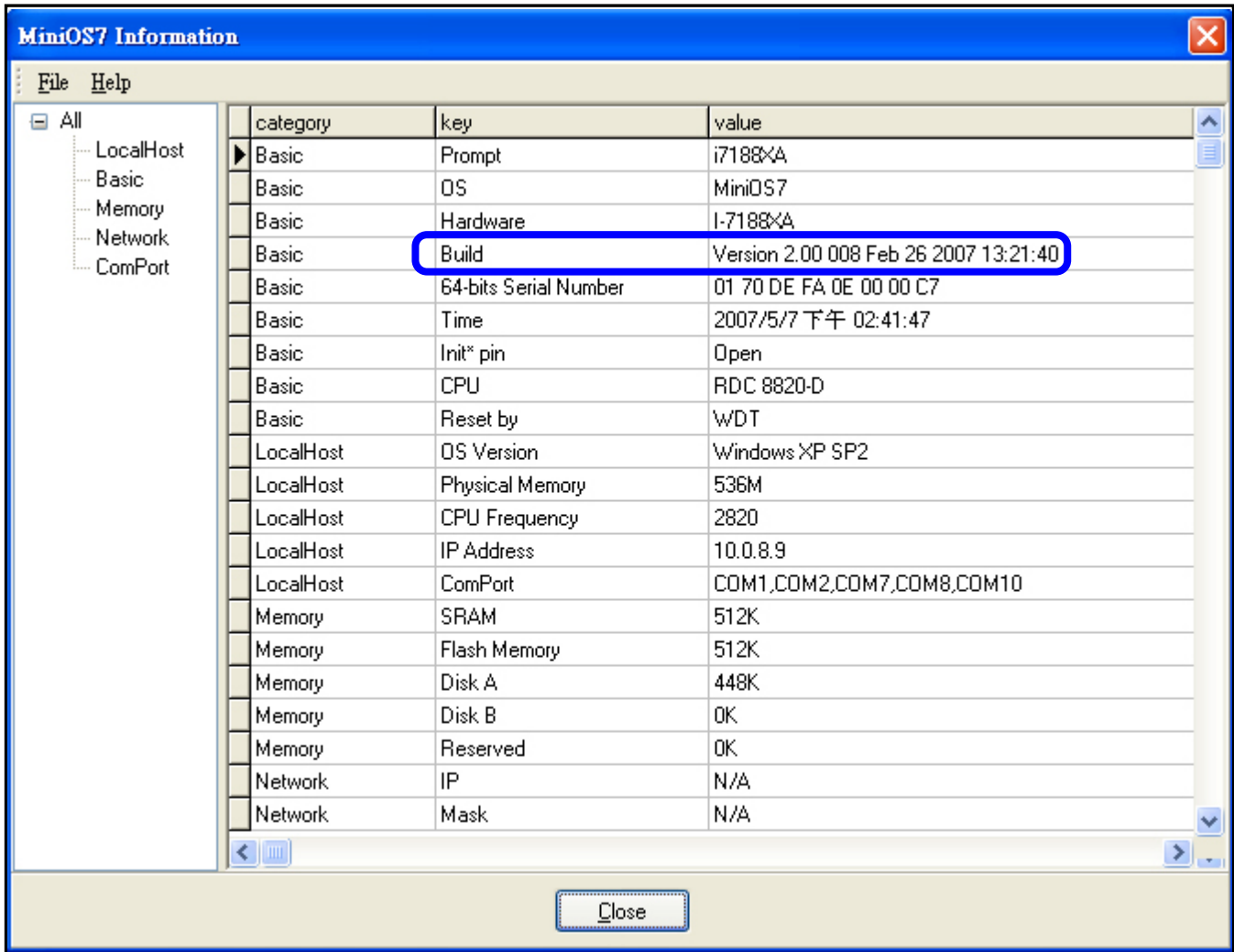

**Note:** Besides using the MiniOS7 Utility to upgrade the MiniOS7, 7188xw.exe can also be used. Refer to **Appendix B: MiniOS7 Utility and 7188XW** for download procedures.



---

## 3. Writing Your First Program

### 3.1 Libraries

There are two function libraries for the I-7188XA(D) module as follows:

- **7188xas.lib** is for programs of the small memory model.
- **7188xal.lib** is for programs of the large memory model.

Both libraries are suitable for TC, BC++, MSC and MSVC++ compilers. All declared functions are described in the header file, **7188xa.h**.

The location of latest Library:

[http://ftp.icpdas.com/pub/cd/8000cd/napdos/minios7/minios7\\_2.0/i-7188xa/lib/](http://ftp.icpdas.com/pub/cd/8000cd/napdos/minios7/minios7_2.0/i-7188xa/lib/) or CD:\Napdos\MiniOS7\MiniOS7\_2.0\i-7188xa\lib

Hundreds of functions are supported in the 7188xas.lib/7188xal.lib files as follows:

Function description	Example
COM port	InstallCOM1, InstallCOM2, InstallCOM3 ..... IsCOM1, IsCOM2, IsCOM3 ..... ToCOM1, ToCOM2, ToCOM3 ..... ReadCom1, ReadCom2, ReadCom3 .....
EEPROM	WriteEEP, ReadEEP, EnableEEP, ProtectEEP
LED and 5-digit LED	LedOn, LedOff, Init5DigitLed, Show5DigitLedWithDot
Flash Memory	FlashReadId, FlashErase, FlashRead, FlashWrite .....
Timer and Watchdog Timer	TimerOpen, TimeClose, TimerResetVlaue, TimerReadValue, StopWatchReset, StopWatchRead, StopWatchStop
File	GetFileNo, GetFileName, GetFilePositionByNo, GetFilePositionByName
Connect to 7000 series modules	SendCmdTo7000, ReceiveResponseFrom7000
Programmable I/O	SetDio4Dir, SetDio4High, SetDio4Low, GetDio4
Others	Kbhit, Getch, Putch, LineInput, Scanf .....

**Note:** For a more detailed description of the functions, please refer to **Appendix D: Library Function List**.

---

## 3.2 Compiler and Linker

A C Language compiler must be used to develop any applications. Valid compilers include:

- BC++ 3.1~5.02
- TC++ 1.01
- TC 2.01
- MSC
- MSVC++ (Prior to version 1.52).

ICP DAS suggests that BC 3.1 is used as the compiler as the libraries provided have been created using the BC 3.1 compiler. Special attention should be paid to the following items before using the compiler to develop custom applications:

- Generate a standard DOS executable program.
- Set the CPU to 80188/80186
- Set the floating point to EMULATION if floating point computation is required. (Make sure not to choose 8087)
- Cancel the Debug Information function as this helps to reduce program size. (MiniOS7 supports this feature.)



# 3.3 The Detailed Steps for Programming

## 3.3.1 Download Turbo C++ version 1.01

Free versions of the Turbo C 2.01 and Turbo C++ 1.01 compilers can be downloaded from the Borland website. The following instructions will help you to install the Turbo C++ version 1.01 compiler on a PC running a Windows operating system.

Step 1: Go to the CodeGear web site (<http://dn.codegear.com/museum>).

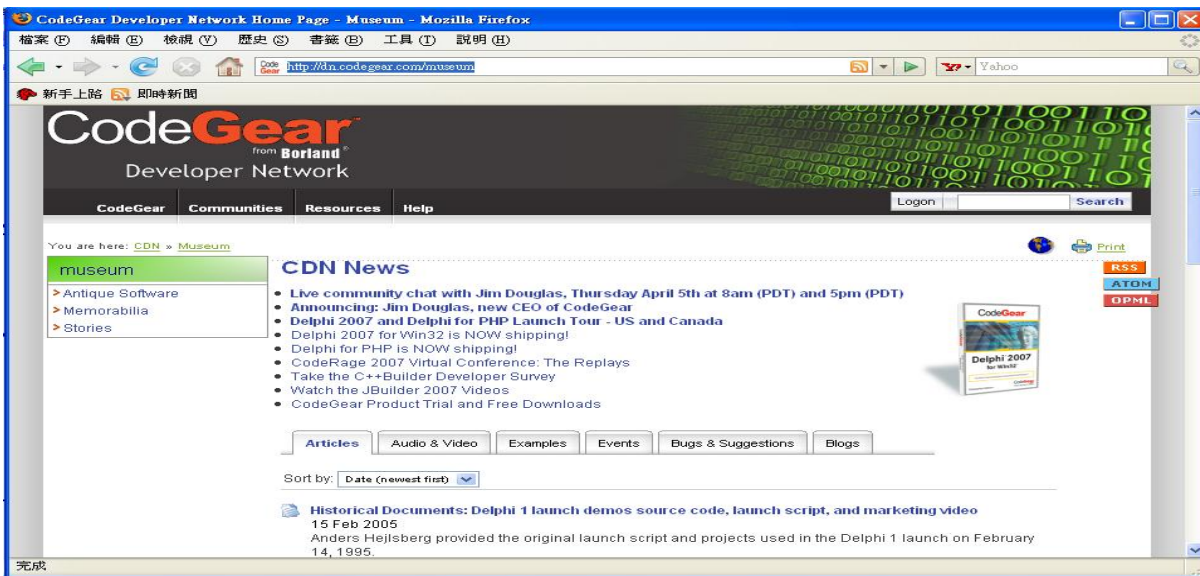

Step 2: Scroll down the bar and click on the link for **Antique Software: Turbo C++ version 1.01** to go to the download page.

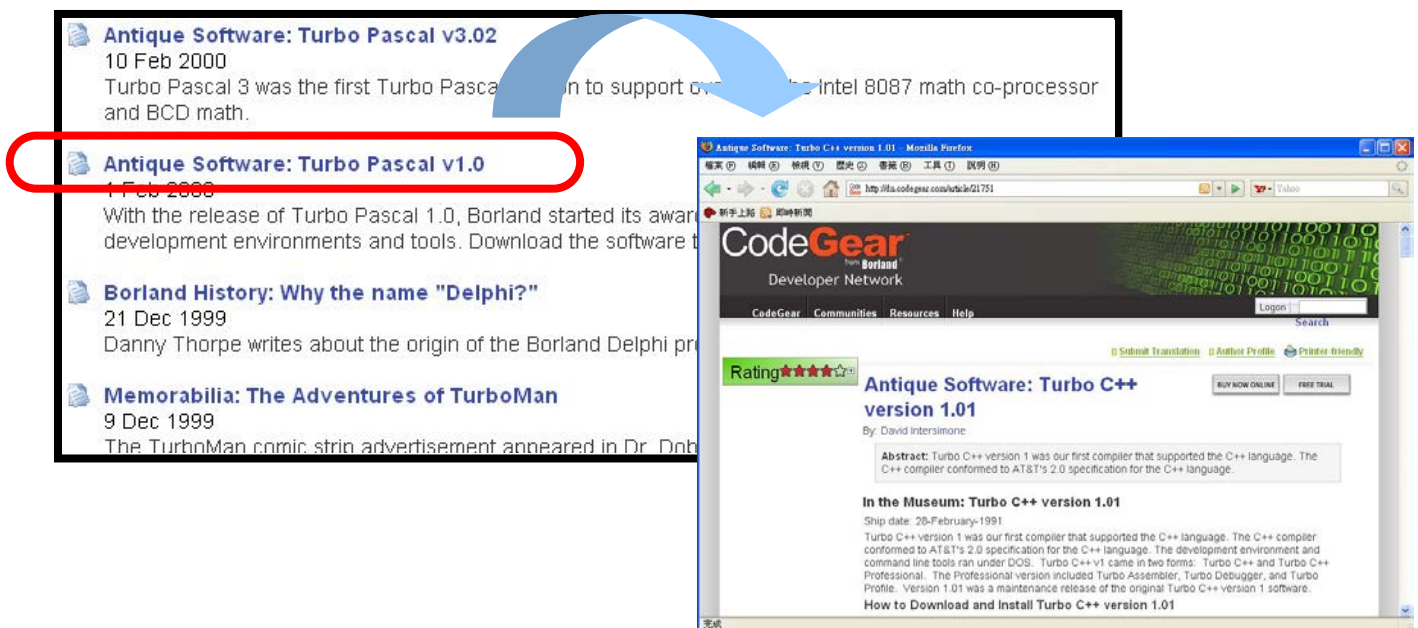

Step 3: Click on the link for **Turbo C++ version 1.01**, as shown below, to download the **tcpp101.zip** file. When requested, save the file to a safe location.

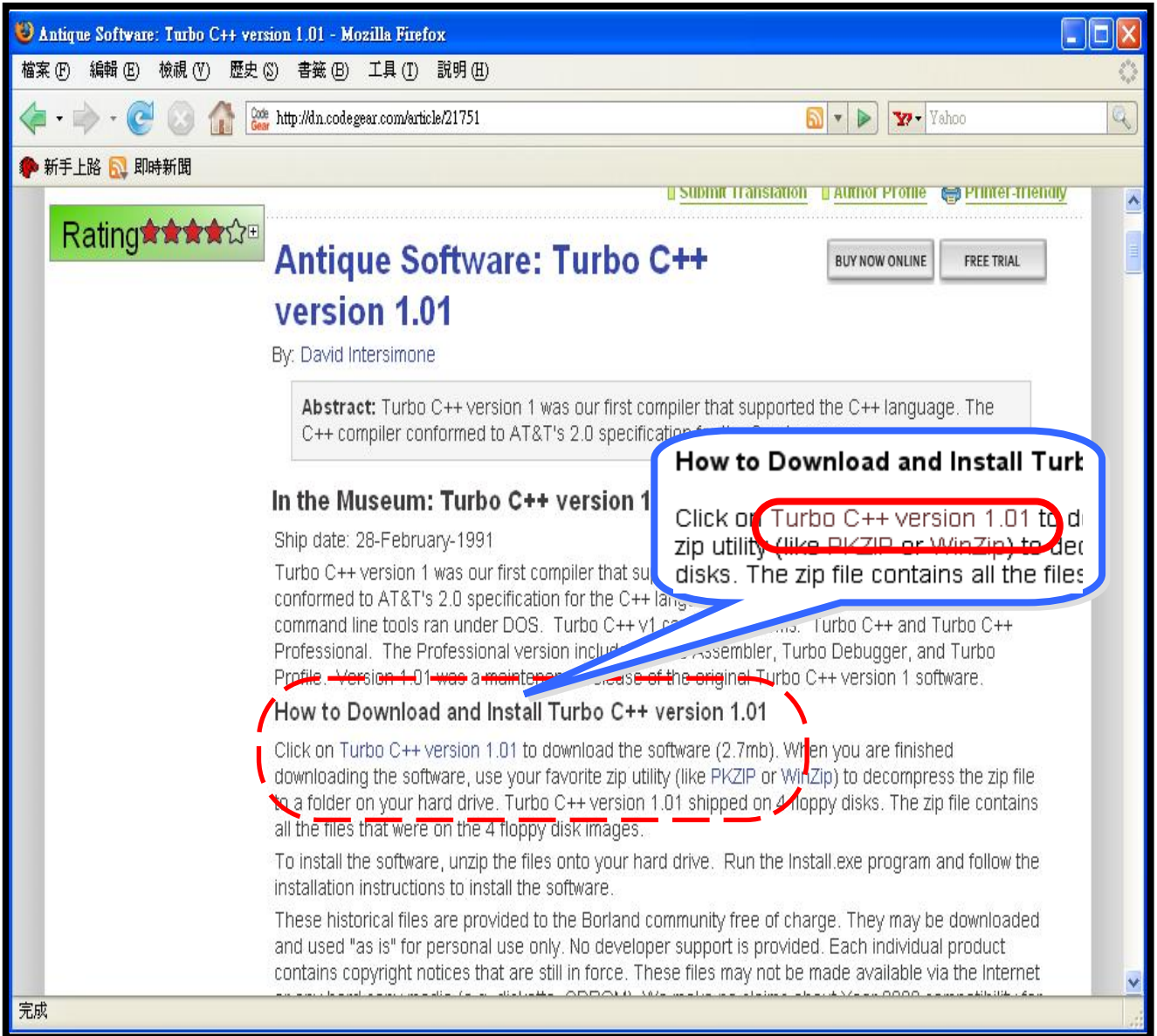

### 3.3.2 Install Turbo C++ version 1.01

- Step 1: Go to where you downloaded the file, and double click on the self-extracting file (tcpp101.zip) in Windows to extract it. This will open a WinZip Self-Extractor window (you do **NOT** need WinZip installed on your machine). By default, this will extract the files to the **C:\tctemp** directory. You may designate a different location.
- Step 2: Once the files have been extracted, exit the WinZip Self-Extractor window.
- Step 3: Open an MS-DOS command prompt window.

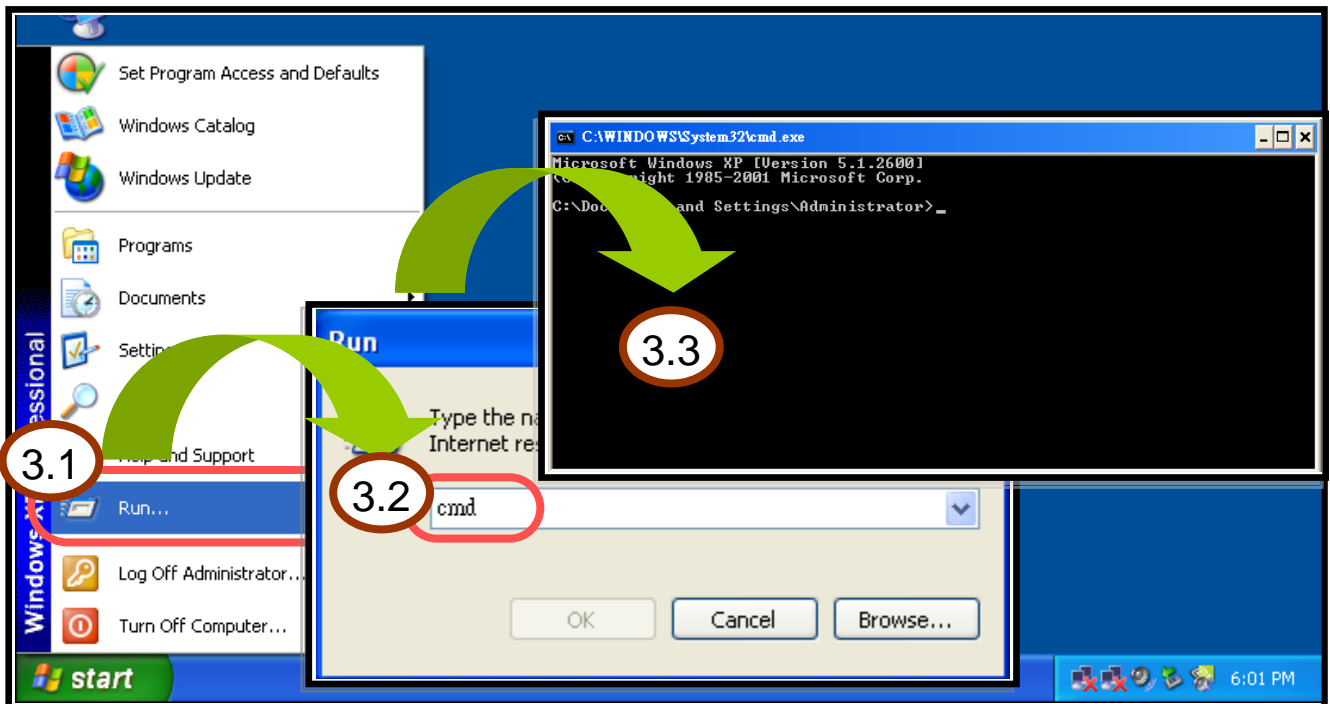

- Step 4: Change the directory to the **c:\tctemp** (or wherever you put the unzipped files folder), and execute the **INSTALL.EXE** file.

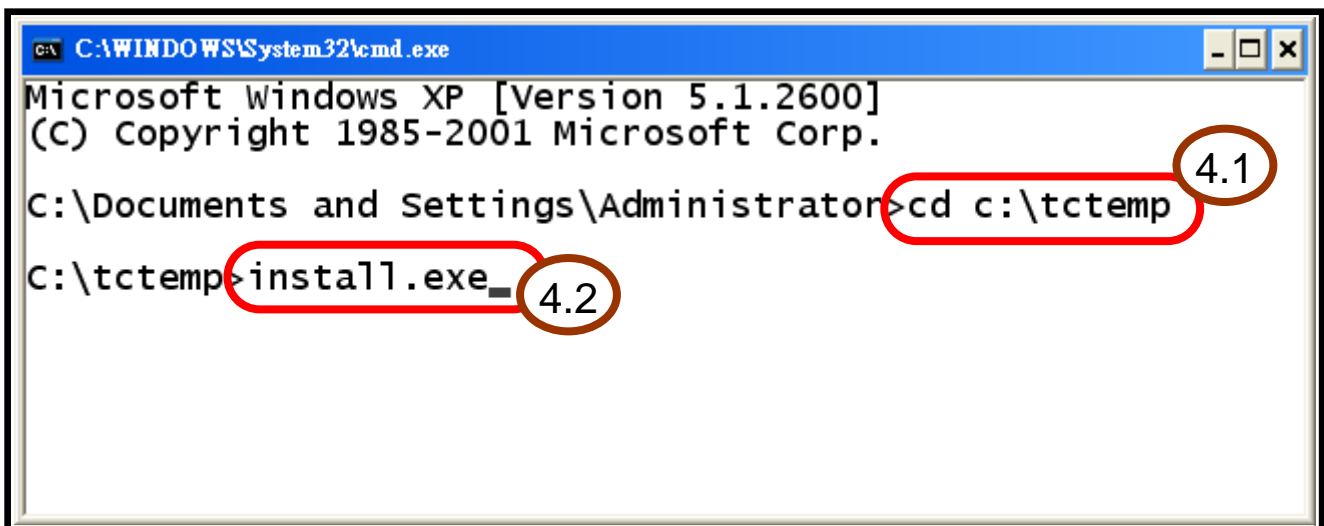

Step 5: The following instructions will guide you through the installation process.

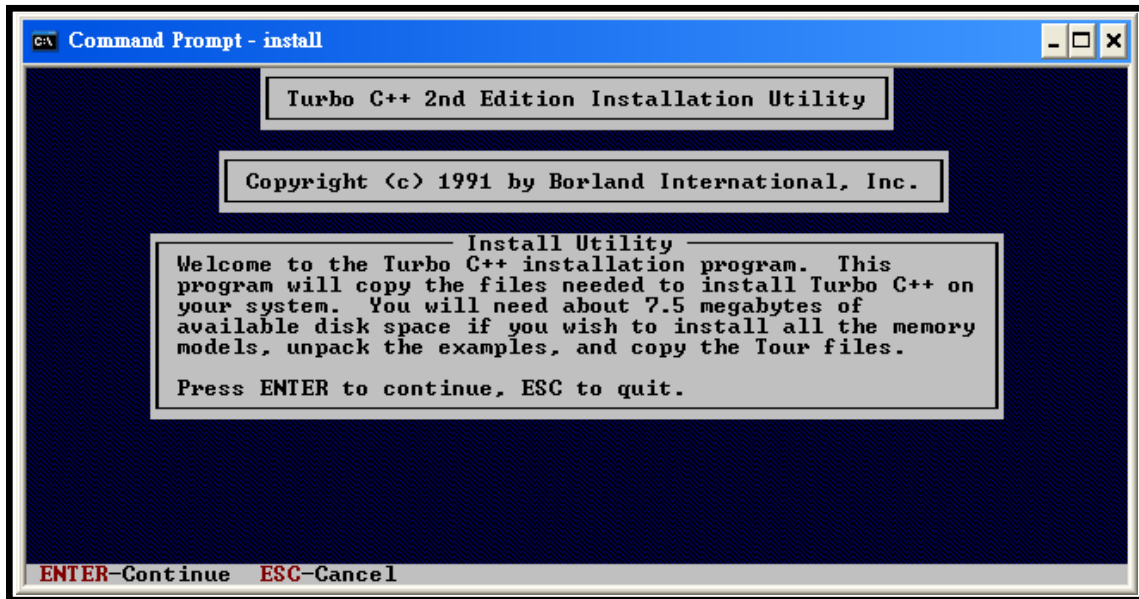

- Step 5.1: Press <ENTER> to start the installation
- Step 5.2: Select the **drive** where the unzipped file is located. The default is "A", so you should enter "C", then press <ENTER>.
- Step 5.3: Press <ENTER> again. This will install the software from the directory \tctemp.
- Step 5.4: Press <ENTER> again. This allows Turbo C to be installed on the Hard Drive.
- Step 5.5: Use the Up/Down arrow keys (Press the up arrow once) to select Start Installation, and then press <ENTER> again.

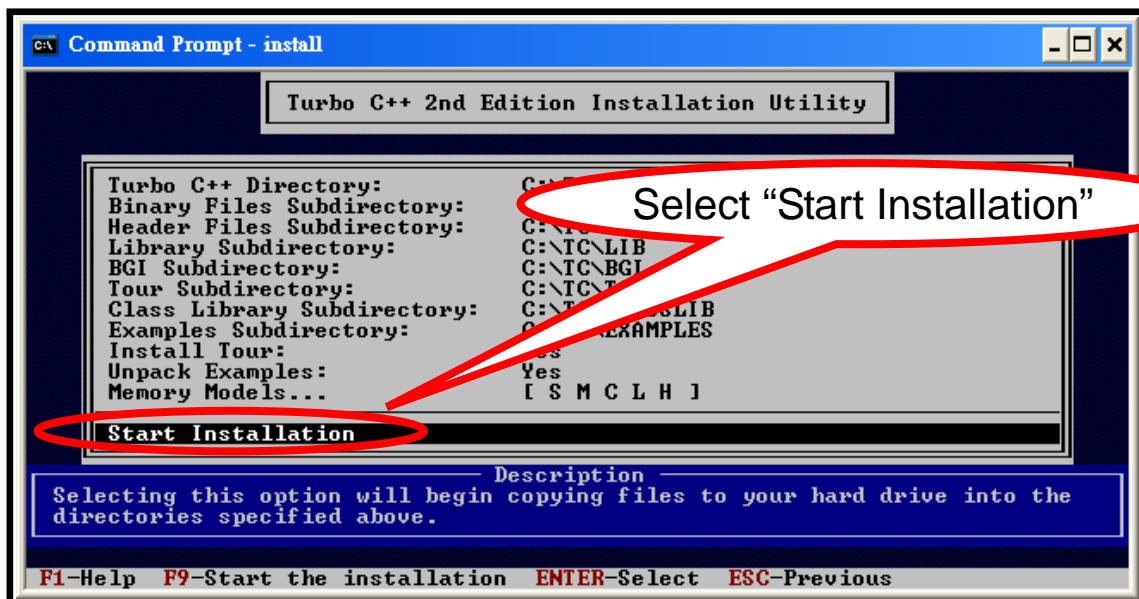



Step 5.6: At this point, the Turbo C++ version 1.01 compiler is installed in C:\TC, which is where the tcc.exe executable is also located.

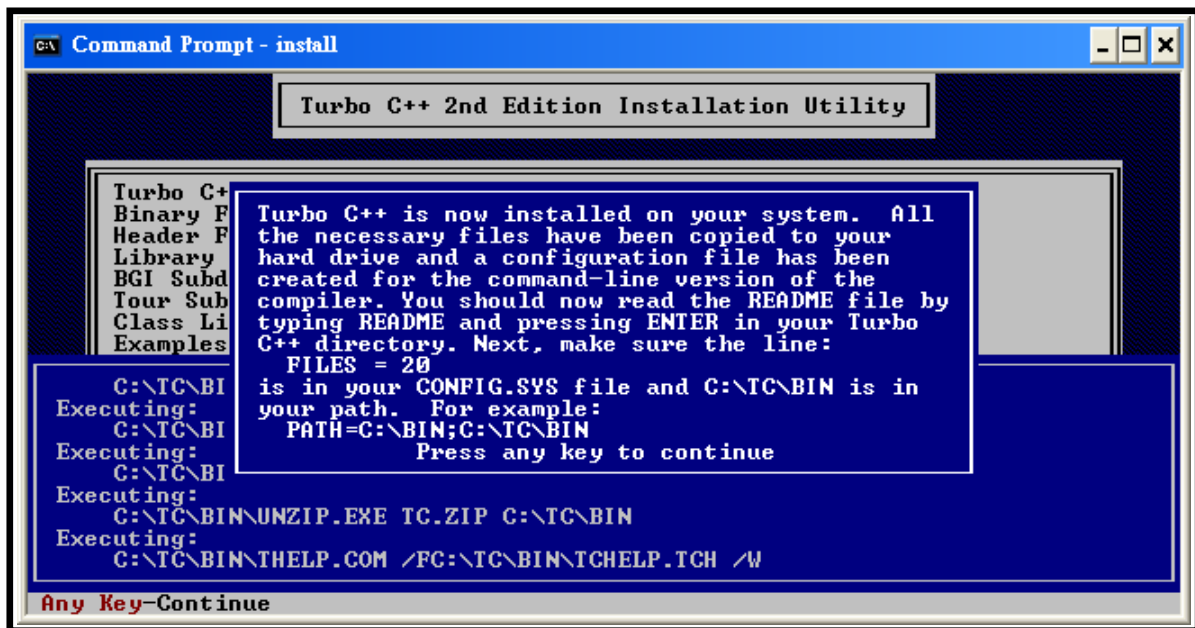

### 3.3.3 Set the environment variables of the system

After installing, you must add C:\TC to your executable search path. The easiest way to do this is as follows:

Step 1: Right-click on the **My Computer** icon on the desktop. (Under Windows XP, the My Computer icon may be located in the start menu) and choose **Properties** from the context menu.

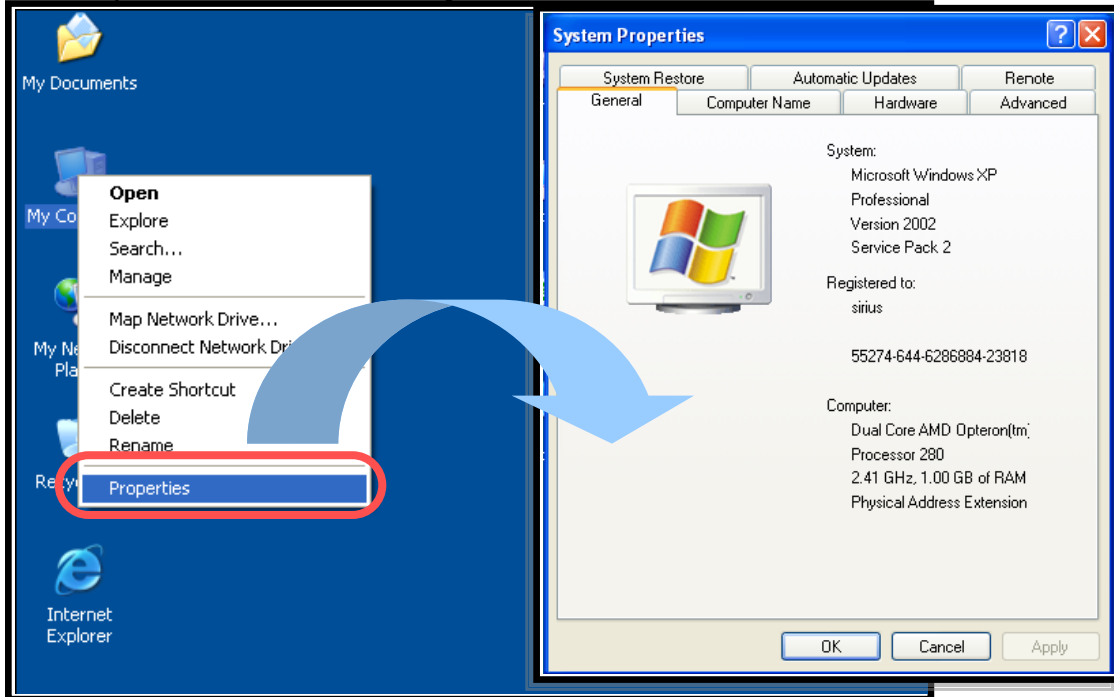

Step 2: Click on the **Advanced** tab, and then click on the **Environment Variables** button.

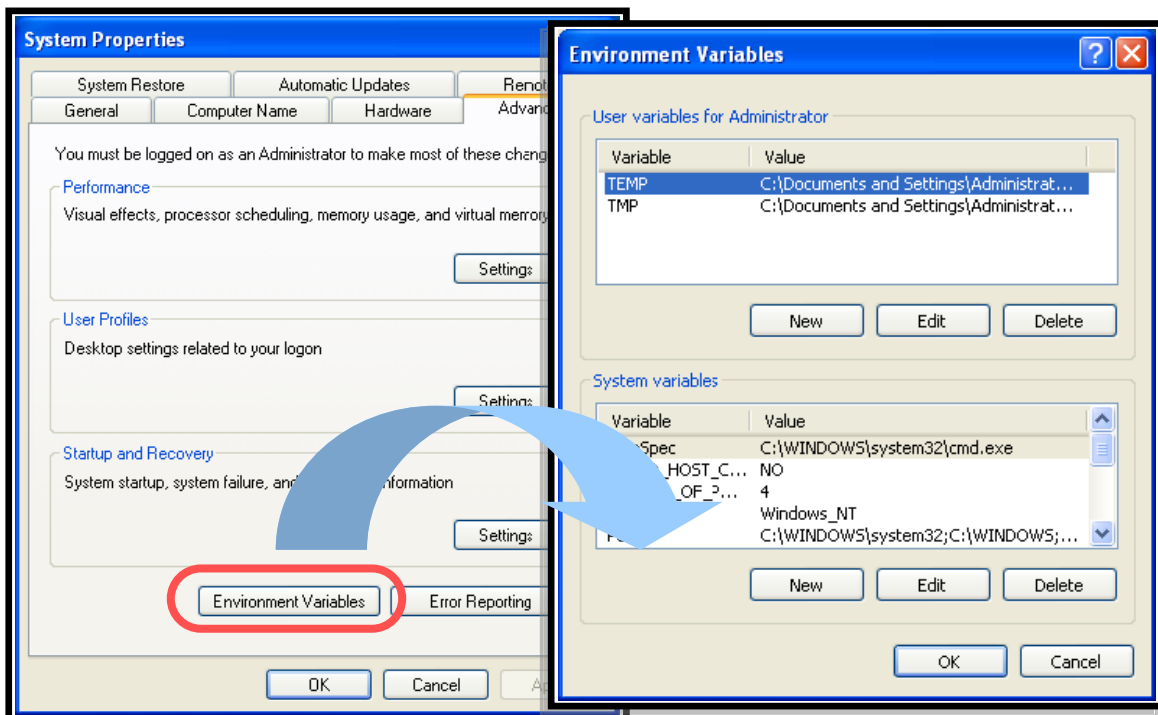

Step 3: In **System variables**, choose the variable **Path** and then click on the **Edit** button.

Step 4: Add the target directory to the end of the **Variable value** using a semi-colon as a separator. For example **"C:\TC\BIN;C:\TC\INCLUDE;"**.

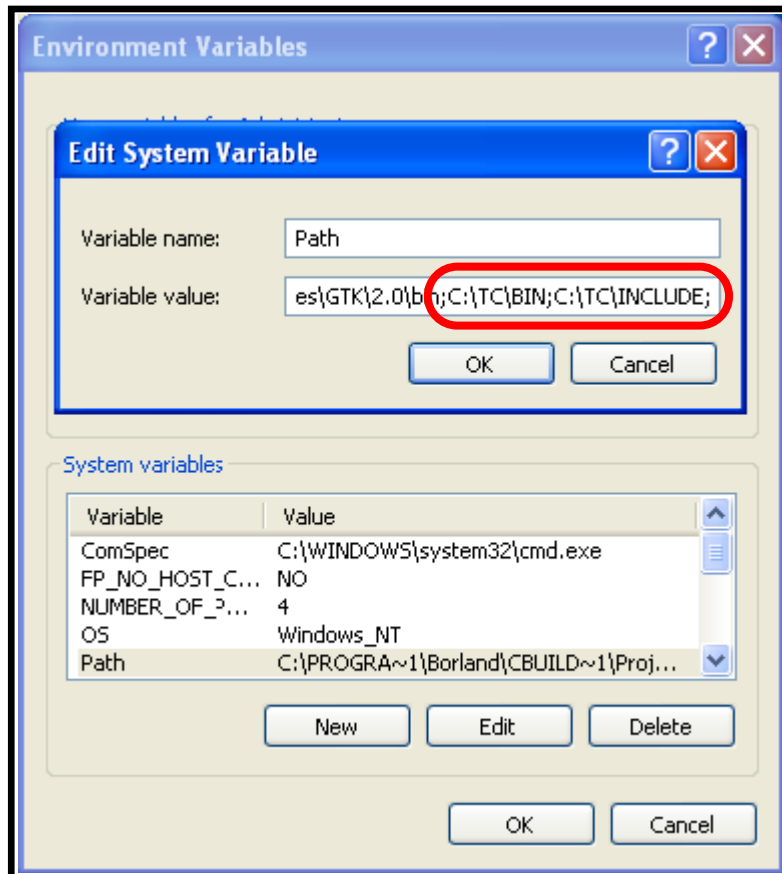

Step 5: Click the **OK** button, and then restart your computer in order for your changes to take effect.

### 3.3.4 Build and Execute the Program

Step 1: Open the MS-DOS command prompt window in the same way as you did in step 3 of the Install Turbo C++ version 1.01 instructions.

**NOTE:** You must close the original MS-DOS command prompt window first.

Step 2: Type “d:” and then press <Enter> to enter D drive letter.

Step 3: Type “cd 7188XA\_test” and press <Enter>.

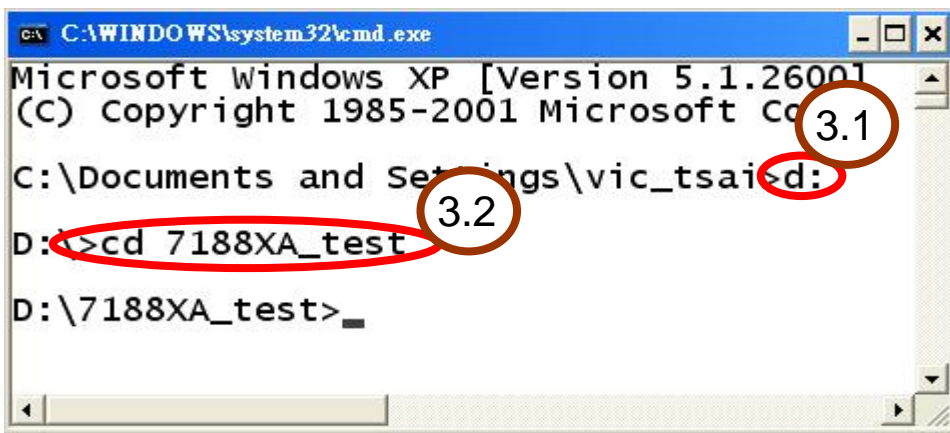

```
C:\WINDOWS\system32\cmd.exe
Microsoft Windows XP [Version 5.1.2600]
(C) Copyright 1985-2001 Microsoft Corporation

C:\Documents and Settings\vic_tsai>d:
D:\>cd 7188XA_test
D:\7188XA_test>
```

**NOTE:** Assume there is a folder, 7188XA\_test, built under d:\. There is a 7188xa.h and 7188xa.lib in the 7188XA\_test folder.

Step 4: Type **tc** and press <ENTER> to run the TC++ 1.01 Integrated Environment. This command can be executed from any location.

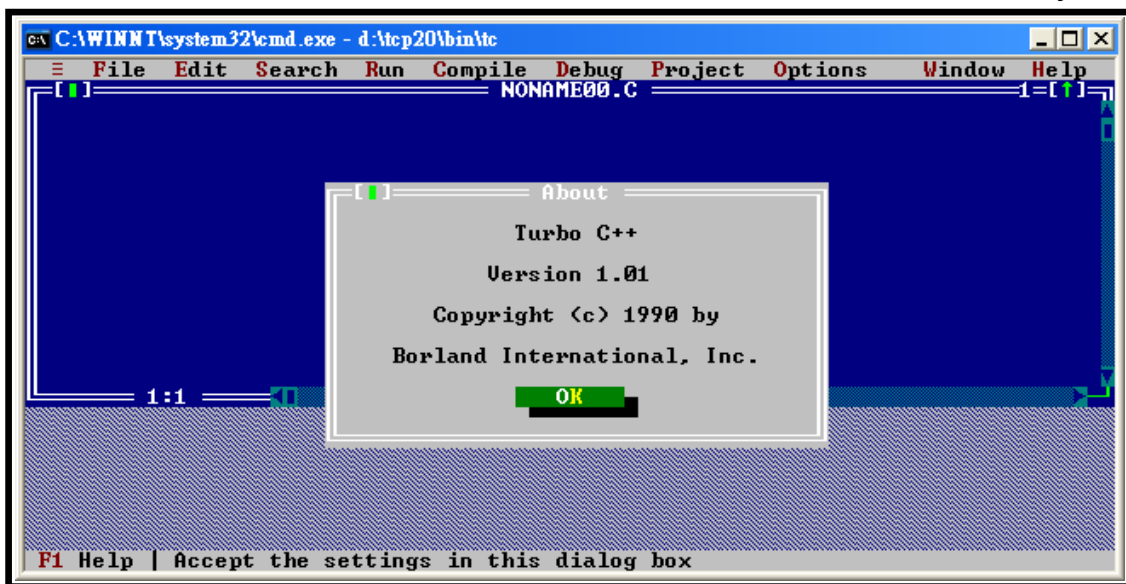



Step 5: Create a source file (\*.c).

Step 5.1: Select **New** from the File menu.

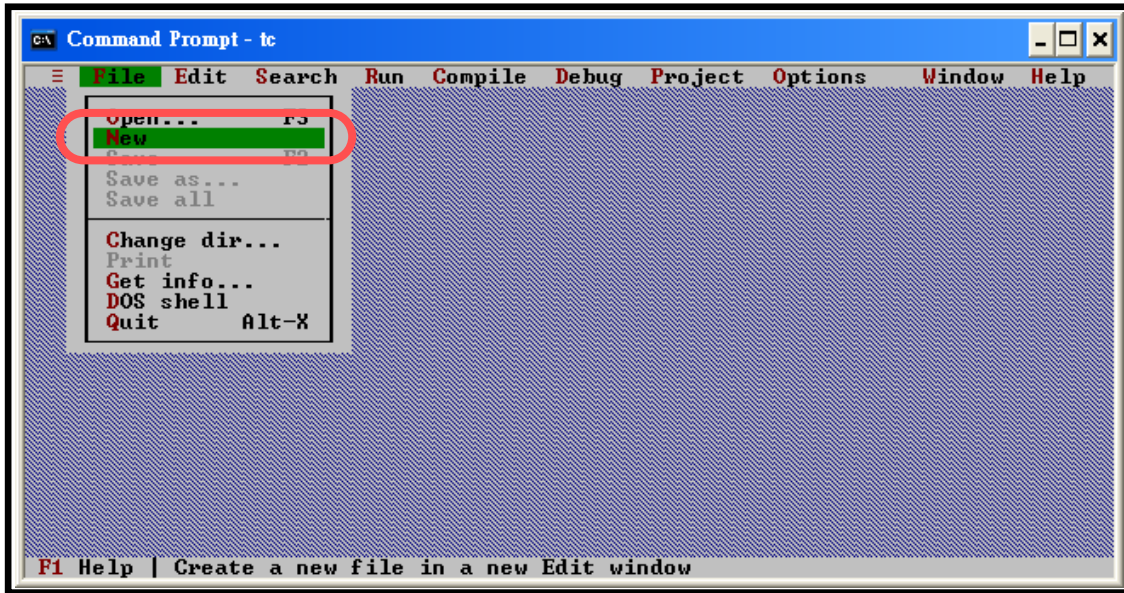

Step 5.2: Type in following code. Note that the code is case-sensitive.

```
#include "7188xa.h"  
  
void main(void)  
{  
    InitLib();  
  
    Print("Hello world!\r\n");  
}
```

Step 5.3: Save the file by selecting **Save** from the File menu, and then enter the file name **Hello.C**.

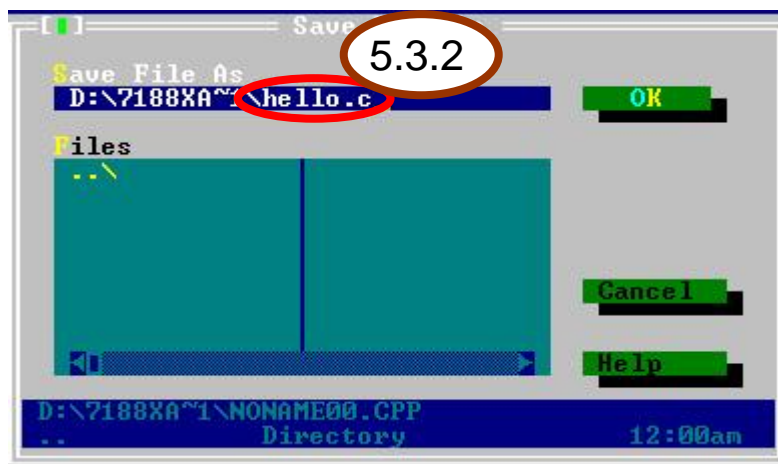
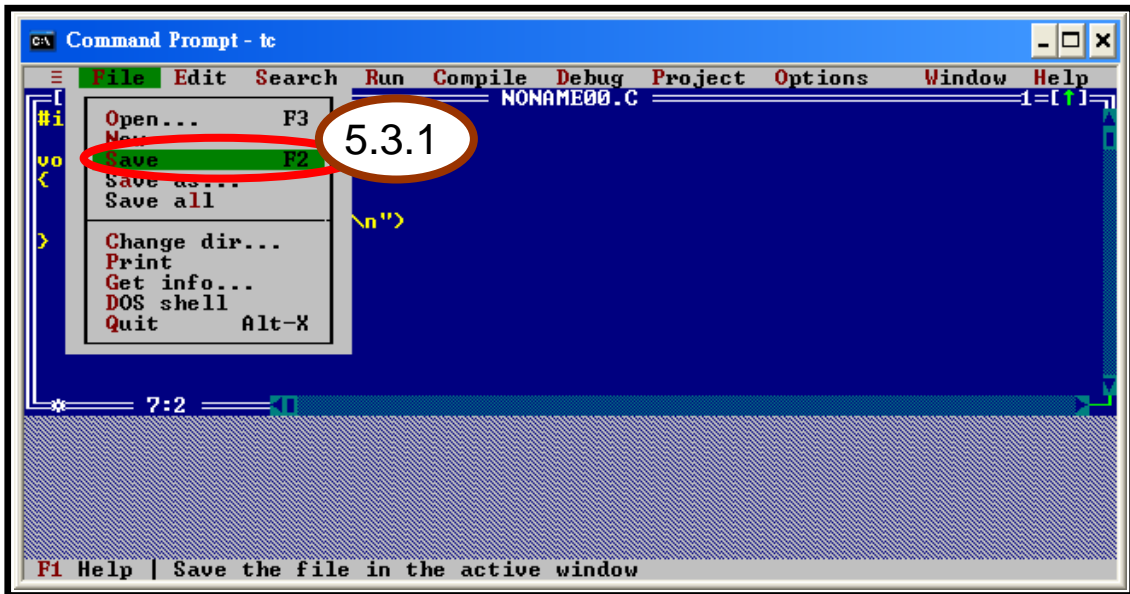

**Note:** If you have a text editor you are familiar with, you may use it to type in the above code. It should be noted that you cannot use a word processor application for this, as you must use an application that saves in plain text, such as notepad or edit. C language program files should always be given a name ending in “.C”.

Step 6: Create a new project file (\*.prj).

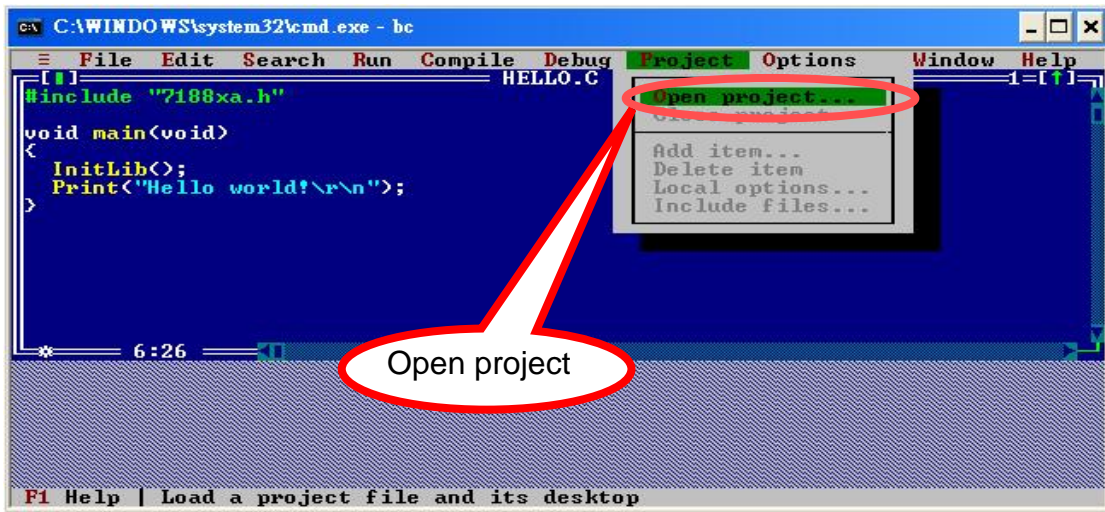

Step 6.1: Type the name of the project file and then click the **OK** button.

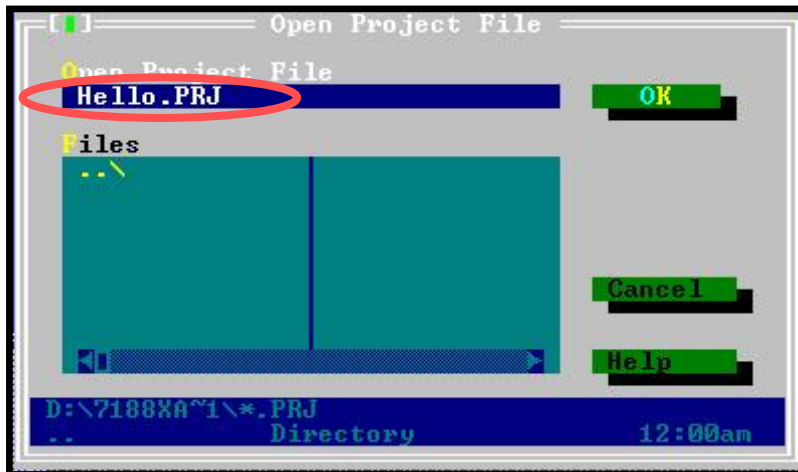

Step 7: Add all necessary files to the project.

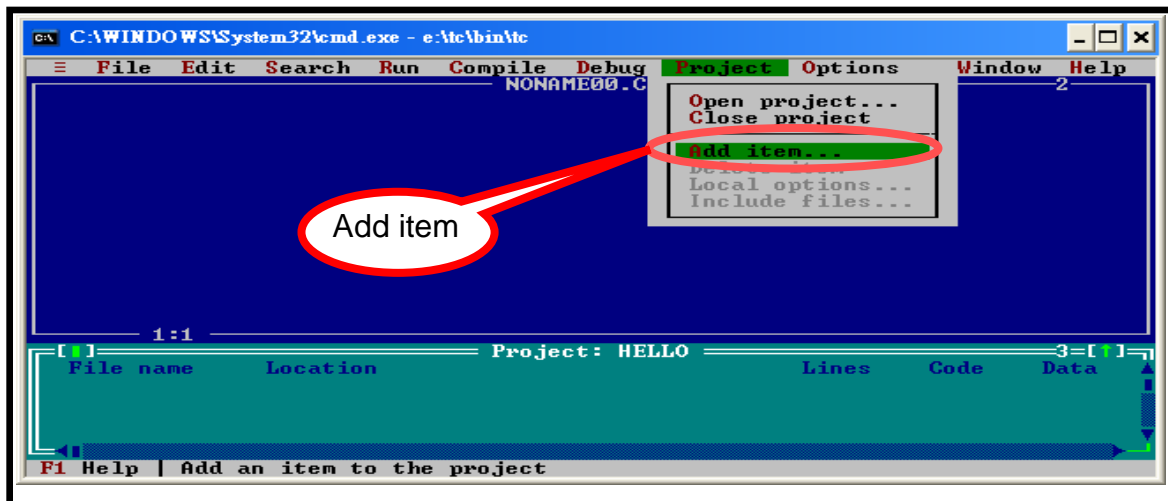

Step 7.1: Select the source file. Type “\*.c” and press **Enter** in A area. If the file you want is in B area, moving the green block to choose the file and click the **Add** button. If not, moving the green block to C area and press **Enter** to search the file.

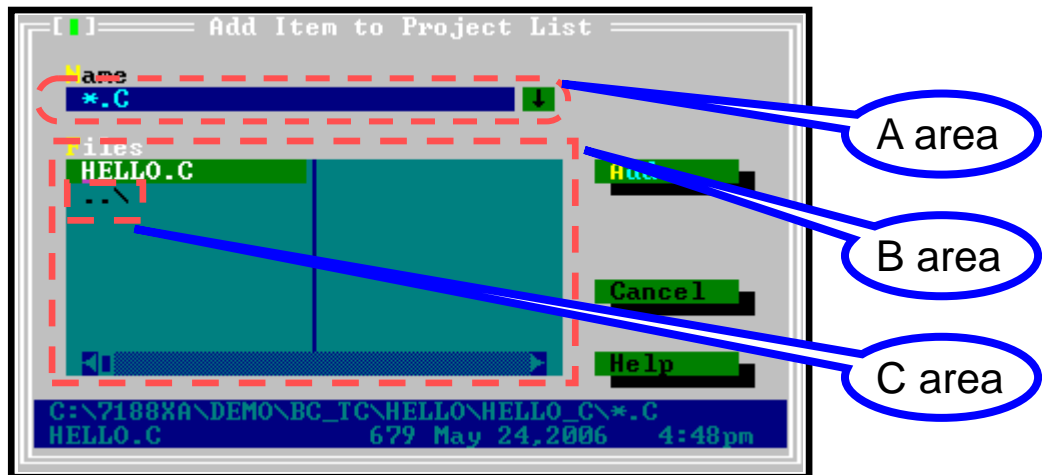

Step 7.2: Select the function library. Type “\*.lib” and press **Enter** in A area. If the file you want is in B area, moving the green block to choose the file and click the **Add** button. If not, moving the green block to C area and press **Enter** to search the file.

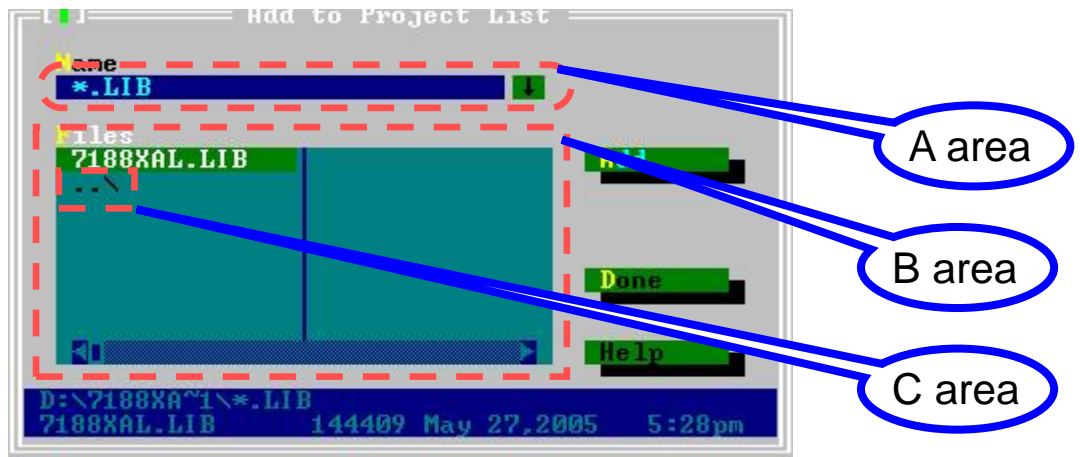

Step 8: Click **Done** to exit.

Step 9: Click on “Options” and select Full menus.

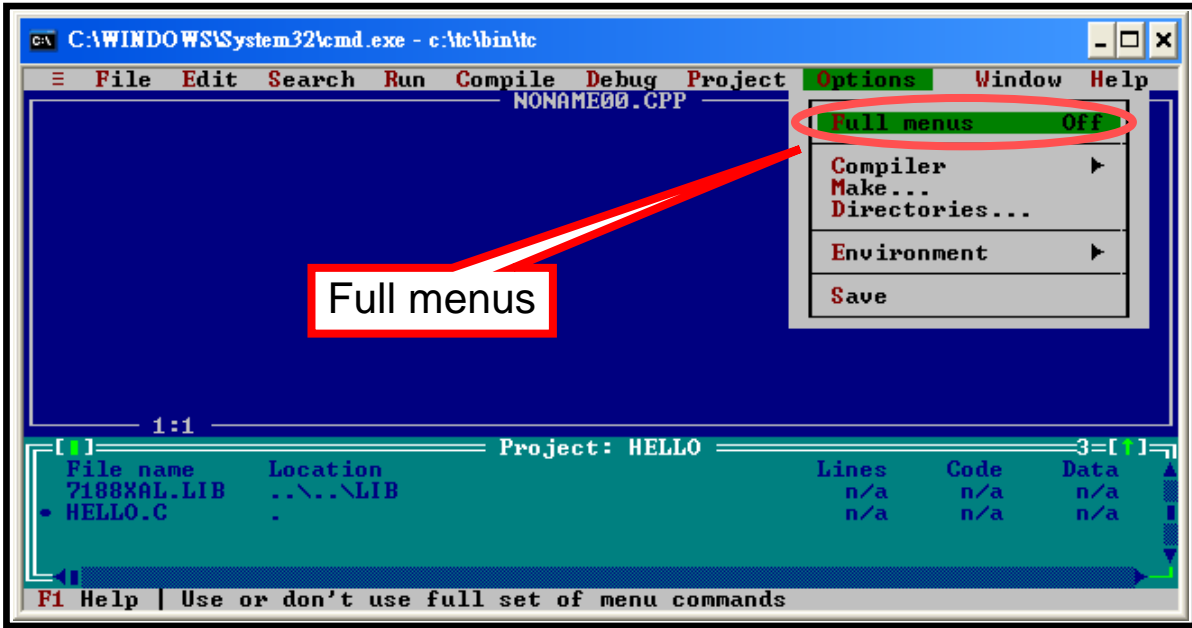

Step 10: Click on “Options” and select the compile menu item, then set the Code generation options.

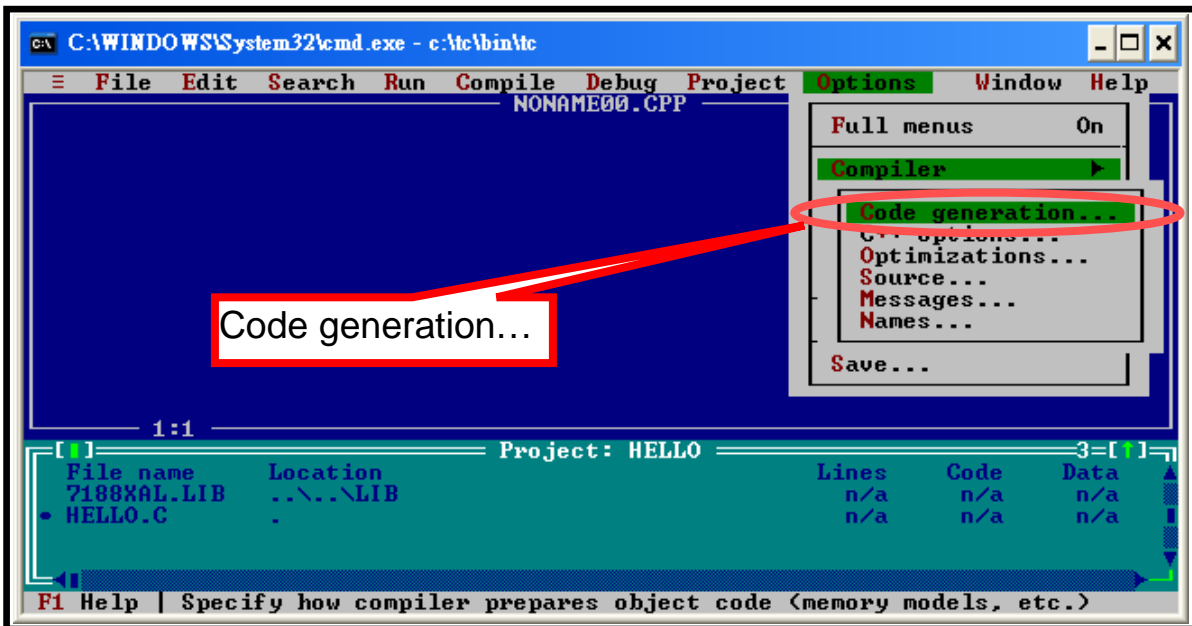

Step 10.1: Change the Memory model (Small for 7188xas.lib, large for 7188xal.lib).

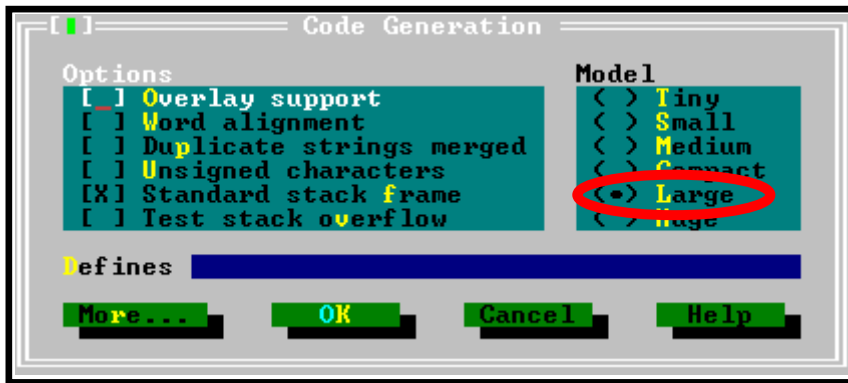

Step 10.2: Click on “**More...**”, then set the Floating Point to **Emulation** and the **Instruction Set** to **80186**.

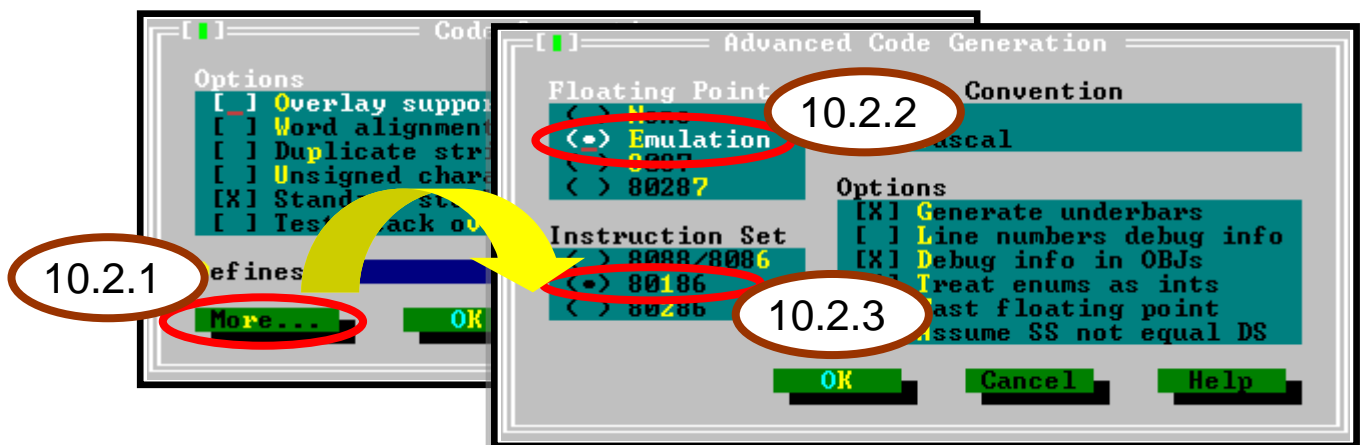

Step 11: Click on “**Options**” and select “**Directories...**” to enter the TC++ 1.01 include and library directories. By default, the directories are same as the installation directory of the TC++ 1.01.

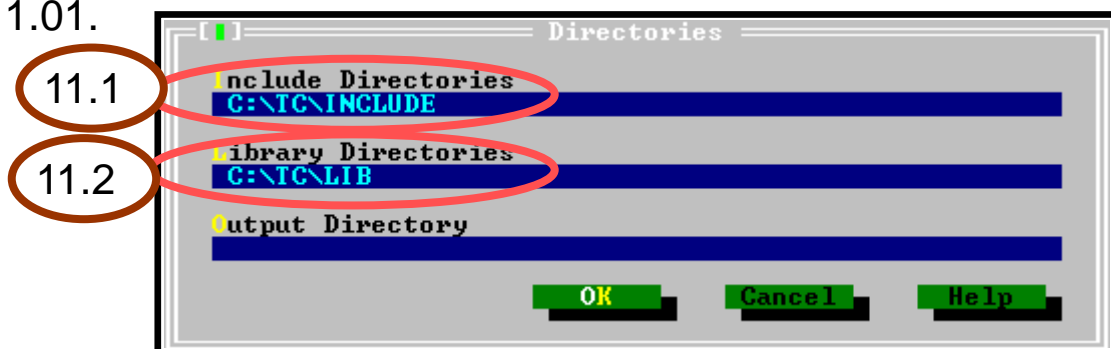

**Note:** The Include Directories specifies the directory that contains the standard include files. The Library Directories specifies the directories that contain the TC++ 1.01 startup object files and run-time library files.



Step 12: Click on “**Compile**” and select “**Make EXE file**” to make the project.

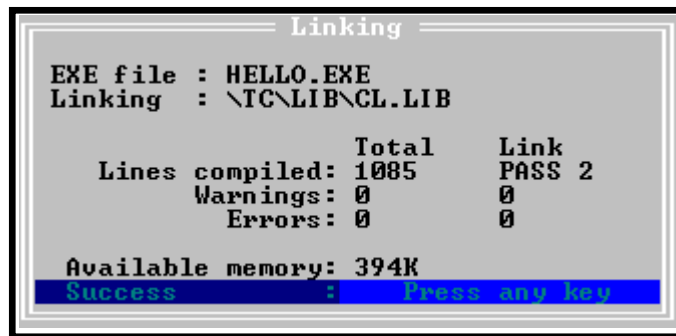
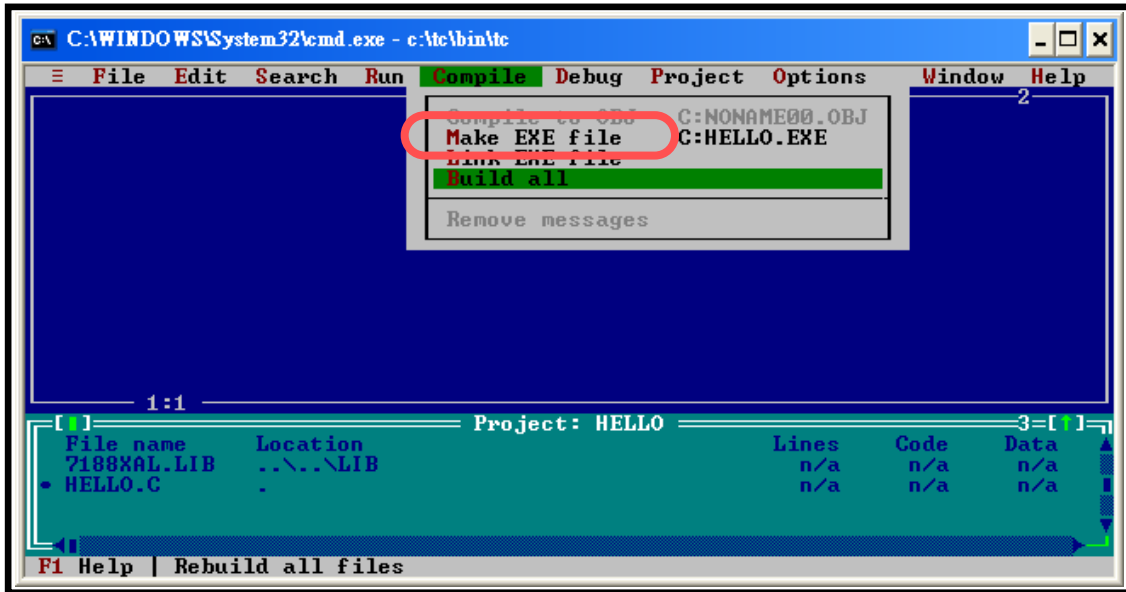

For instructions related to the downloading and execution of programs, please refer to Section 2.3.

For more detailed information regarding compiling and linking related to the various C compilers (TC/BC/MSC/MSVC), please refer to **Appendix E: Compiling and linking**.

---

## 3.4 Building project on 64-bit platform

If trying to use 16-bit compiler like BC3.1 or TC++3.0 to build MiniOS7 project on Windows 64-bit platform like Windows 7 or Windows 8, it will prompt up an error message to show compatibility problem for 64-bit platform.

Please refer to the section “Compiling on 64-bit platform like Windows 7 or Windows 8 / 8.1” in Appendix E Compiling and linking.



---

## 4. Operating Principles

### 4.1 System Mapping

Device	Address mapping
Flash ROM	512K: from 8000:0000 to F000: FFFF
SRAM	512K: from 0000:0000 to 7000: FFFF
COM1 BASE	0x100
COM2 BASE	0x108
COM3	0XFF80 to 0XFF88
COM4	0XFF10 to 0XFF18

Interrupt No.	Interrupt mapping
0	Divided by zero
1	Trace
2	NMI
3	Break point
4	Detected overflow exception
5	Array bounds exception
6	Unused opcode exception
7	ESC opcode exception
8	Timer 0
9	Reserved
0A	DMA-0
0B	DMA-1
0C	\INT0 of the I/O expansion bus
0D	\INT1 of the I/O expansion bus
0E	COM1 (\INT2 of the I/O expansion bus)
0F	COM2 (\INT3 of the I/O expansion bus)
10	\INT4 of the I/O expansion bus
11	COM4
12	Timer 1
13	Timer 2
14	COM3

---

## 4.2 Debugging custom Programs using COM4

The COM4 Port (download port) of the I-7188XA(D) has three major functions.

- Downloading programs from the Host PC
- Connecting to the Host PC to enable program debugging
- Acting as a general-purpose COM port

When the I-7188XA(D) is switched on, it will initialize COM4 in the following configuration under **console mode**:

- **Start Bit=1, Data Bit=8, Stop Bit=1, no parity**
- **Baud Rate=115200 bps**

The I-7188XA(D) will check the status of the INIT\* pin. **If the INIT\* pin is shorted to the GND pin**, the I-7188XA(D) will send the start up information to COM4 and enter **console mode** to allow the user to download/debug a program, and the following start up messages will be displayed.

- Power off the Host PC and I-7188XA(D)
- Connect the download cable between COM4 on the I-7188XA(D) and the COM Port of the Host PC (refer to Section 2.2 for more details)
- Switch on the power for the Host PC and execute the 7188xw.exe
- Switch on the power for the I-7188XA(D)
- All initialization messages will be shown on the monitor of the Host PC

**If the INIT\* pin is open**, the I-7188XA(D) will search for the **autoexec.bat** file. If the autoexec.bat file is present, the I-7188XA(D) will execute it. If the autoexec.bat file is not present, the I-7188XA(D) will revert to console mode to allow the user to download/debug a program.

After completing the initialization stage, the I-7188XA(D) will use the COM4 as its standard input/output. The standard output of the I-7188XA(D) will be shown on the monitor of the Host PC. If a key is pressed on the keyboard of the Host PC, the key code will be echoed to the I-7188XA(D) as standard input. Therefore both the keyboard and

---

monitor of the Host PC can be used as standard input and output for the I-7188XA(D) as follows:

- Use 7188xw.exe or MiniOS7 Utility as a bridge between the I-7188XA(D) and the Host PC
- Execute 7188xw.exe or the MiniOS7 Utility on the Host PC to setup this bridge
- The keyboard of the Host PC → standard input of I-7188XA(D)
- The monitor of the Host PC → standard output of I-7188XA(D)

In this way, the I-7188XA(D) can read data from the keyboard and display it on the monitor. Thus, debugging a program will be easier and effective.

**Note:** 7188xw.exe and the MiniOS7 Utility are provided on the companion CD. Please refer to Section 2.2 for detailed wiring information and Section 2.3 for details of how to download programs.

---

## 4.3 Using the Download Port as a COM Port

The download port (COM4) of the I-7188XA(D) can be used as a general purpose RS-232 port in the following manner:

- Step 1: Download custom programs and autoexec.bat to I-7188XA(D) first.
- Step 2: Switch off the I-7188XA(D) and remove the download cable from the Host PC.
- Step 3: Disconnect the INT\* pin from the GND pin of the I-7188XA(D) if they are connected.
- Step 4: Switch on the I-7188XA(D) (no standard input, no standard output, no debug information).
- Step 5: Connect a download cable between a new RS-232 device and the COM4 of the I-7188XA(D).
- Step 6: Initialize the COM4 to the new configuration.
- Step 7: The COM4 of the I-7188XA(D) can now be used a general purpose RS-232 port.

## 4.4 Functions and Demo Programs List

There are several demo programs that designed for I-7188XA(D). For more detailed information regarding these programs, please refer to the contents in later sections. The functions of the demo programs are as follows:

Folder	Demo program	Explanation	Section
Hello	Hello_C	Detecting if the operation system is MiniOS7.	3.3.4
	Hello_C++	<b>Note:</b> MSC does not support C++ language. The Hello_C++ file is only supported by BC.	
COM_Port	C_Style_IO	1. Shows how to write a function to input data. 2. Shows how to retrieve a string. 3. Shows how to use a C function: sscanf, or just use Scanf().	4.6
	Receive	Receive data from the COM Port.	
	Slv_COM	The PC sends commands to the I-7188XA(D), and receives responses from the I-7188XA(D). Also shows how to use another COM Port or LED to show information to help debug a program.	
	ToCom_In_Out	Reads/writes the byte data via the COM Port.	
DateTime		Reads the date and time from an RTC and prints it on a monitor (user can also set the date and time).	
IO_PIN		Reads/writes the DO and DI of the I-7188XA(D).	4.11
LED	Led	Shows how to use the DelayMs function to switch the LED ON or OFF.	4.7
	Seg7led	Controls the red LED and 5-digit 7-segment LED.	
File	Config_1_Basic	In many applications, a text file is needed in order to record specific information so that the program can read it. FSeek can be used to retrieve specific information from a text file.	
	Config_2_Advanced	Extends config_1_Basic, and adds GetProFileInt, GetProFileFloat and GetProFileStr. These functions can be used to determine the "Type" from a text file.	

Memory	Demo5	Shows how to access the NVRAM.	4.8
	EEPROM	Writes a value to the EEPROM and shows it on the monitor.	
	EEPROM-r	Reads the data that has been written to the EEPROM.	
	EEPROM-w	Inputs a value and stores it in an EEPROM block 1 peer address (value will automatically increase by 1).	
	Flash	Reads, writes and erases the Flash memory.	
	Flash-r	Reads the value that has been written to the Flash memory.	
	Flash-w	Inputs a value written in the Flash memory (value will automatically increase by 1).	
	NVRAM-r	Reads the value that has been written to NVRAM.	
	NVRAM-w	Writes a value to the NVRAM (value will automatically increase by 1).	
	Top-Mem	Demonstration of the AllocateTopMemory function	
Misc	Reset	Restores the initial values.	
	Runprog	Uses the Ungetch function to run another program.	
	SerialNumber	Retrieves the serial number of the I-7188XA(D).	
	Watchdog	Enables the Watchdog or bypasses the enabled Watchdog.	4.9
7K87K_Module	7K87K_demo_for_com	Show how to connect and control the 7k or 87k series modules via COM2.	4.6.3
	7K87K_AI_for_Com		
	7K87K_DI_for_Com		
	7K87K_DIO_for_Com		
	7k87K_DO_for_Com		
	AO_024_for_Com		
AO_22_26_for_Com			
Timer	Demo90	A demonstration program showing how to use the Timer function.	4.10
	Demo91	Show how to use the CountdownTimer function on channel 0 to switch the LED ON or OFF.	
	Demo92	Shows how to use the StopWatch function on channel 0 to switch the LED ON or OFF.	

	Demo96	Shows how to use the InstallUserTimer function to control the 5-digit 7-segment LED.	
	Demo97	Shows how to use the DelayMs function to switch the LED ON or OFF.	
	Demo98	Shows how to use the I-7188XA(D) timer function to send/receive data to or from 7000 series modules.	
XBoard		These are demo programs for all I/O expansion boards that are applicable to the I-7188XA(D).	4.12

---

## 4.5 COM Port Comparison

The I-7188XA(D) COM ports are as follows:

COM Port	Hardware
COM1	16C550, 9-wire RS-232 (Default) or 2-wire RS-485
COM2	16C550, 2-wire RS-485
COM3	80188's on-chip UART-0, 3-wire RS-232
COM4	80188's on-chip UART-1, 3-wire RS-232

The I-7188XA(D) COM Ports can be set as RS-232 or RS-485 as below:

COM Port Type	Pin name
2-wire RS-485	Data+, Data-
3-wire RS-232	TXD, RXD, GND
9-wire RS-232	TXD, RXD, GND, RTS, CTS, DCD, DTR, DSR, RI

The programming required for the 16C550 is very different from the 80188 UART. Interrupt handling on the 80188 is also very different from the 8259 on a PC. Therefore, the RS-232 application programs for PC are not executed in I-7188XA(D).

The software driver for the I-7188XA(D) is an interrupt driven library that provides a 1K QUEUE buffer for each COM Port. The software is well designed and easy to use.

The software driver provides the same interface for all four COM Ports, so each port can be used in the same way without any difficulty.



---

## 4.6 Using the COM Ports

The 7188XA(D) has four communication ports.

- COM1 can act as either an RS-232 (Default) or RS-485 port  
RS-232: TXD, RXD, RTS, CTS, DTR, DSR, DCD, RI GND  
RS-485: D1+, D1- (Self-tuner ASIC inside)
- COM2 is an RS-485 port (D1+, D1-, Self-tuner ASIC inside)
- COM3 is an RS-232 port (TXD3, RXD3, GND)
- COM4 is an RS-232 port (TXD4, RXD4, GND)

Before using the COM Port, the ***InstallCom()*** (or ***InstallCom1/2/3/4()***) function must be called to install the driver for the COM Port.

Before exiting the program, the ***RestoreCom()*** (or ***RestoreCom1/2/3/4()***) function must be called to uninstall the driver.

After calling the ***InstallCom()*** function, data can be read from the COM Port, sent to the COM Port, printed from the COM Port and so on.

Before reading data from the COM port, the ***IsCom()*** function should be used to check if any data has already been sent to the COM Port. If yes, then the ***ReadCom()*** function should be used to read the data from input buffer of the COM Port.

Before sending data to the COM Port, the ***ClearCom()*** function could be used to make sure the output buffer of the COM Port is clear, then use the ***ToCom()*** function to send data to the COM Port.

For example, the code to echo the data back to COM4 (RS-232) is shown below.

```
int port=4; /*to use COM4*/  
int quit=0, data;  
  
InitLib(); /* Initiate the 7188xa library */  
InstallCom(port, 115200L, 8, 0, 1); /*install the COM driver*/  
while(!quit){  
    if(IsCom(port)){ /*check if any data is in the COM Port input buffer*/  
        data=ReadCom(port); /*read data from the COM Port*/  
        ToCom(port, data); /*send data via the COM Port*/
```

```

        if(data=='q') quit=1; /*if 'q' is received, exit the program*/
    }
}
RestoreCom(port); /*uninstall the COM driver*/

```

Use the “port” variable to switch from COM4 to COM2, simply change **port=4** to **port=2**.

If the program is set to use COM4, the code can be altered as follows:

```

int quit=0, data;

InitLib(); /* Initiate the 7188xa library */
InstallCom4(115200L, 8, 0, 1); /*install the COM4 driver*/
while(!quit){
    if(IsCom4()){ /*check if any data is in the COM4 input buffer*/
        data=ReadCom4(); /*read data from COM4*/
        ToCom4(data); /*send data via COM4*/
        if(data=='q') quit=1; /*if 'q' is received, exit the program*/
    }
}
RestoreCom1(); /*uninstall the COM driver*/

```

#### 4.6.1 To print from the COM port

The I-7188XA(D) library also supports functions such as **printf()** from the standard C library to produce a formatted output.

The **printCom()** function can be used for all COM Ports, and **printCom1/2/3/4** can be used for individual ports. Before using the **printCom()** function, the **InstallCom()** function must first be called. The code is shown below:

```

int port=2; /*to use COM2*/
int i;

InitLib(); /* Initiate the 7188xa library */
InstallCom(port, 115200L, 8, 0, 1); /*install the COM2 driver*/
for(i=0; i<10; i++){
    printCom(port, "Test %d\r\n", i); /*print data from COM2*/
}
RestoreCom(port); /*uninstall the COM driver*/

```

#### 4.6.2 To Use COM1/COM2 for an RS-485 Application

COM1/COM2 is a 2-wire RS-485 COM Port, and includes the following 2 pins:

- D+: connect to the Data+ of the RS-485 network
- D-: connect to the Data- of the RS-485 network

COM1/COM2 is a half-duplex 2-wire RS-485 network and cannot be used in a full-duplex 4-wire application. It is designed to directly drive I-7000 series modules.

Send/receive directional control in a 2-wire RS-485 network is very important. Therefore, the I-7188XA(D) is equipped with a Self-Tuner ASIC controller for all RS-485 ports, which will automatically detect and control the send/receive direction of the RS-485 network. In this manner, the application programmer does not have to worry about the send/receive direction control for the RS-485 network.

#### 4.6.3 To Send a Command to an I-7000 module

The commands used for I-7000 series modules are very different from those of the I-7188XA(D), but commands can be sent from the I-7188XA(D) to a I-7000 module using the **ToCom()** function.

## Using COM1/COM2 to connect and control I-7000 modules

The procedure for I-7000-related applications is as follows:

- Step 1: The I-7188XA(D) sends a command string to the I-7000 series modules.
- Step 2: The destination I-7000 modules execute the command.
- Step 3: The destination I-7000 modules delay by 1 byte to allow for setting time.
- Step 4: The destination I-7000 modules echo the result string back to the I-7188XA(D).

**Note:** The delay time used in step 3 is only 1 byte.

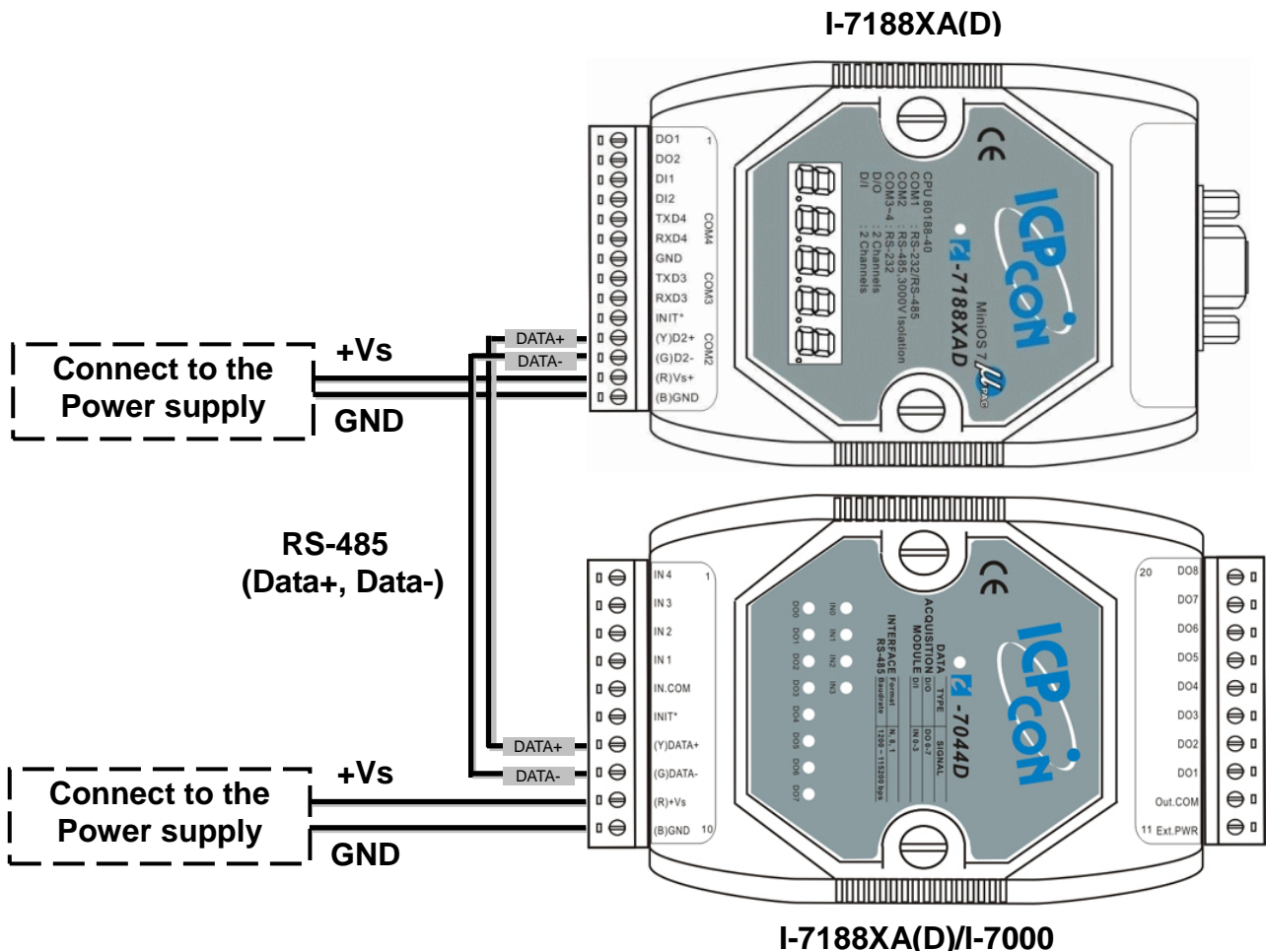

The example code for sending a command to COM2 (RS-485) is shown below.

```

int port=2; /*to use COM2*/
int i;
char data[ ]="$01Mr"; /*command to read a module's name*/

InitLib(); /* Initiate the 7188xa library */
InstallCom(port); /*install the COM2 driver*/
for(i=0; i<5; i++)
    ToCom(port, data[i]); /*send a command to the I-7000 module*/
..... /*program code*/
RestoreCom(port); /*uninstall the COM driver*/

```

In addition to using the **ToCom()** function, the **SendCmdTo7000()** function can also be used to send commands to an I-7000 series module. The **ReceiveResponseFrom7000()** function can be used to receive the response from an I-7000 series module.

#### Functions used to connect to an I-7000 module:

- **SendCmdTo7000(int iPort, unsigned char \*cCmd, int iChecksum);)**

This function sends a command to an I-7000 series module. If the checksum is enabled, the function will add 2 bytes checksum to the end of the command.

- **ReceiveResponseFrom7000\_ms(int iPort, unsigned char \*cCmd, long ITimeout, int iChecksum);)**

After calling the **SendCmdTo7000()** function the **ReceiveResponseFrom7000\_ms()** function can be called to retrieve a response from an I-7000 series module.

Refer to the demo programs in the CD:\Napdos\7188XABC\7188XA\Demo\BC\_TC\7K87K\_Module directory for more detailed information.

**Note:** For more I-7000 commands, please refer to the “**user’s manual for 7000 DIO**”. When using COM1 as an RS-485 COM port, the settings for JP6 on the I-7188XA(D) is as follows.

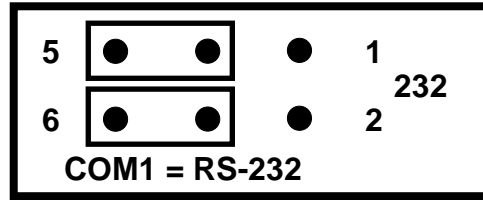
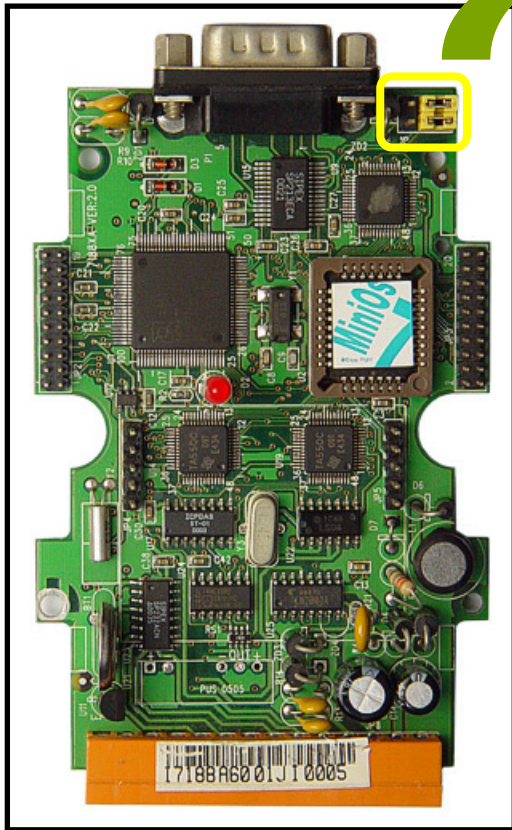

---

## 4.7 Using the Red LED and 7-SEG LED Display

The I-7188XAD includes a 5-digit 7-segment LED, together with a decimal point, which can be switched on or off using software. Each digit of the LED is numerically identified from left to right using the numbers 1 to 5, and is individually programmable, which can be very useful in real world applications and can be used to replace a monitor or touch screen in many applications.

Before attempting to use the LED, the ***Init5DigitLed()*** function must first be called, then the ***Show5DigitLed()*** function can be used to display data. The code required to display “7188d” on 5-digit 7-segment LED is as follows:

```
Init5DigitLed();  
Show5DigitLed(1, 7);  
Show5DigitLed(2, 1);  
Show5DigitLed(3, 8);  
Show5DigitLed(4, 8);  
Show5DigitLed(5, 13); /* The ASCII code for 'd' is 13 */
```

Refer to the demo programs in the  
CD:\Napdos\7188XABC\7188XA\Demo\BC\_TC\LED folder for more  
information.

---

## 4.8 Accessing the I-7188XA(D) Memory

### 4.8.1 Using Flash Memory

The I-7188XA(D) module contains 512K bytes of Flash memory which includes space reserved for the MiniOS7. The MiniOS7 occupies the 0xF000 segment. So user can use the other segments whose total size is 448K bytes.

Each bit of the Flash memory can only be written from 1 to 0 and cannot be written from 0 to 1. The only way to change the data from 0 to 1 is to call the **EraseFlash()** function to erase a block from the Flash Memory (64K bytes). The user should decide whether to write to the block or to erase it.

To write an integer to segment 0xD000, offset 0x1234 of the Flash Memory, the code is as follows:

```
int data=0xAA55, data2;
char *dataptr;
int *dataptr2;

InitLib(); /* Initiate the 7188xa library */

dataptr=(char *)&data;
FlashWrite(0xd000, 0x1234, *dataptr++);
FlashWrite(0xd000, 0x1235, *dataptr);

/* read data from the Flash Memory method 1 */
dataptr=(char *)&data2;
*dataptr=FlashRead(0xd000, 0x1234);
*(dataptr+1)=FlashRead(0xd000, 0x1235);

/* read data from the Flash memory method 2 */
dataptr2=(int far *)_MK_FP(0xd000, 0x1234);
data=*data
```

Reading data from the Flash Memory is somewhat like reading data from SRAM. The user should allocate a far pointer to point to the memory location first, and then use this pointer to access the memory.



---

Before writing data to Flash Memory, the user must first call the **FlashWrite()** function, and check whether data can be written or not. After calling the **EraseFlash()** function, data can be written to that segment.

Refer to the demo programs in the CD:\Napdos\7188XABC\7188XA\Demo\BC\_TC\Memory folder for more information.

### 4.8.2 Using RTC and NVSRAM

The I-7188XA(D) module contains both an RTC and NVRAM, which are located on the same chip, and an onboard Li battery that is used as backup for at least 10 years. The features of the RTC are as follows:

- BIOS support for RTC time and data
- MiniOS7 supports RTC time and date
- Seconds, minutes, hours, date of the month
- Month, day of the week, year (Leap year valid up to 2079)
- NVSRAM: 31 bytes

The NVSRAM can be read/written any number of times. The features of NVSRAM are as follows:

- Data Validity: 10 years
- Read/write cycles: unlimited
- Total 31 bytes

The **ReadNVRAM()** function can be used to read one byte of data from the NVRAM and **WriteNVRAM()** function can be used to write one byte of data to the NVRAM. The code to write data to NVRAM address 0 is shown below.

```
int data=0x55, data2;  
  
InitLib(); /* Initiate the 7188xa library */  
WriteNVRAM(0, data);  
data2= ReadNVRAM(0); /* now data2=data=0x55 */
```

---

To write an integer (two bytes) to the NVRAM, use the code shown below.

```
int data=0xAA55, data2;
char *dataptr=(char *)&data;

WriteNVRAM(0, *dataptr);      /* write the low byte */
WriteNVRAM(1, *dataptr+1);    /* write the high byte */
dataptr=(char *)&data2;
*dataptr=ReadNVRAM(0);       /* read the low byte */
(*dataptr+1)=ReadNVRAM(1);   /* read the high byte */
/* now data2=data=0xAA55 */
```

Refer to the demo programs in the CD:\Napdos\7188XABC\7188XA\Demo\BC\_TC\Memory folder for more information.

### 4.8.3 Using EEPROM

The EEPROM is designed to store data that is not changed frequently, such as:

- Module ID, configuration settings
- COM port configuration settings
- Small databases

The erase/write cycle of the EEPROM is limited to 1,000,000 erase/write cycles, so it should not be changed frequently when testing. The EEPROM can be erased/written in a single byte, so it is very useful in real world applications.

The I-7188XA(D) has 2K bytes of EEPROM memory, containing 8 blocks and each block contains 256 bytes, giving a total of 2048 bytes of EEPROM memory. Normally, the EEPROM is in protected mode by default, meaning that no data can be written to the EEPROM. The ***EE\_WriteEnable()*** function must be called to unprotect it before writing any data.

---

For example: To write data to EEPROM block1, address 10, first call the ***EE\_WriteEnable()*** function . The code is shown below.

```
int data=0x55, data2;  
  
InitLib(); /* Initiate the 7188xa library */  
EE_WriteEnable();  
EE_MultiWrite(1, 10, 1, &data);  
EE_WriteProtect();  
  
EE_MultiRead(1, 10, 1, &data2); /* now data2=data=0x55 */
```

**Note:** To write an integer to EEPROM, the ***EE\_WriteEnable()*** function must be called twice, in the same manner as writing data to NVRAM.

Refer to the demo programs in the  
CD:\Napdos\7188XABC\7188XA\Demo\BC\_TC\Memory folder for more  
information.

---

## 4.9 Using the Watchdog Timer

The watchdog timer of the I-7188XA(D) is fixed at 0.8 seconds for MiniOS7 2.0. When the I-7188XA(D) is first powered on, the watchdog timer will be always enabled. If the watchdog timer is not refreshed within 0.8 seconds, it will reboot the I-7188XA(D).

The MiniOS7 of the I-7188XA(D) will automatically refresh the watchdog after being powered on. User programs can call the software driver to stop the MiniOS7 from refreshing the watchdog timer, but the program must then refresh the watchdog timer manually. If the program does not refresh the watchdog timer every 0.8 seconds, it will cause the I-7188XA(D) to reboot.

The program must then ask the MiniOS7 to reset the watchdog timer, then stop and return to the MiniOS7 command prompt.

Use the ***EnableWDT()*** function to enable the watchdog timer or use the ***DisableWDT()*** function to disable it. After the watchdog is enabled, the program should call the ***RefreshWDT()*** function before the timer count reaches 0.8 seconds, otherwise the watchdog will reboot the I-7188XA(D) module. The sample code is as follows:

```
EnableWDT();  
while(!quit  
{  
    RefreshWDT();  
    User_function();  
}  
DisableWDT();
```

The ***IsResetByWatchDogTimer()*** function is used to check whether the I-7188XA(D) module has been rebooted by the watchdog timer. This function must be inserted at the beginning of program. The sample code is as follows:

```
main()
{
  InitLib();    /* Initiate the 7188xa library */

  if(IsResetByWatchDogTimer())
  {
    /* do something here to check the system */
  }
  quit=0;
  EnableWDT();
  while(!quit)
  {
    RefreshWDT();
    User_function();
  }
}
```

Refer to the demo programs in the  
CD:\Napdos\7188XABC\7188XA\Demo\BC\_TC\Misc folder for more  
information.

---

## 4.10 Using the Timer Function

The I-7188XA(D) can support one main time tick, 8 StopWatch timers and 8 Countdown timers. The I-7188XA(D) uses a single 16-bit timer to perform these timer functions, with a timer accuracy of 1 ms. The ***InstallUserTimer()*** function can be used to install a custom timer function and the function will be called at 1 ms intervals. The system timer of the MiniOS7 will call INT 9 every 1 ms and call INT 0x1C every 55 ms. The timer function of the library is linked to associated with called by hooked to INT 9 and will call any custom timer function.

The ***TimerOpen()*** function is used to start the I-7188XA(D) timer, and this function must be inserted at the beginning of the program. The ***TimerClose()*** function is used to stop the timer. The sample code is as follows:

```
unsigned long time iTime;  
  
InitLib(); /* Initiate the 7188xa library */  
TimerOpen(); /* Begin using the 7188XA timer function */  
while(!quit)  
{  
    if(Kbhit())  
        TimerResetValue(); /* Reset the main time ticks to 0 */  
  
    iTime=TimerReadValue(); /* Read main time ticks */  
}  
TimerClose(); /* Stop using the 7188XA timer function */
```

Refer to the demo programs in the CD:\Napdos\7188XABC\7188XA\Demo\BC\_TC\Timer folder for more information.

---

## 4.11 Using Digital Input and Digital output

The I-7188XA(D) provides 2 DI channels and 2 DO channels. The **SetDo1On()**, **SetDo1Off()**, **SetDo2On()** and **SetDo2Off()** functions can be used to control the two DO channels, and the **GetDi1()** and **GetDi2()** functions can be used to read the states of the two DI channels.

For DI and DO wiring information, please refer to **Section 1.4.6 DI and DO Wire Connection**.

The wiring for a DO application is as follows:

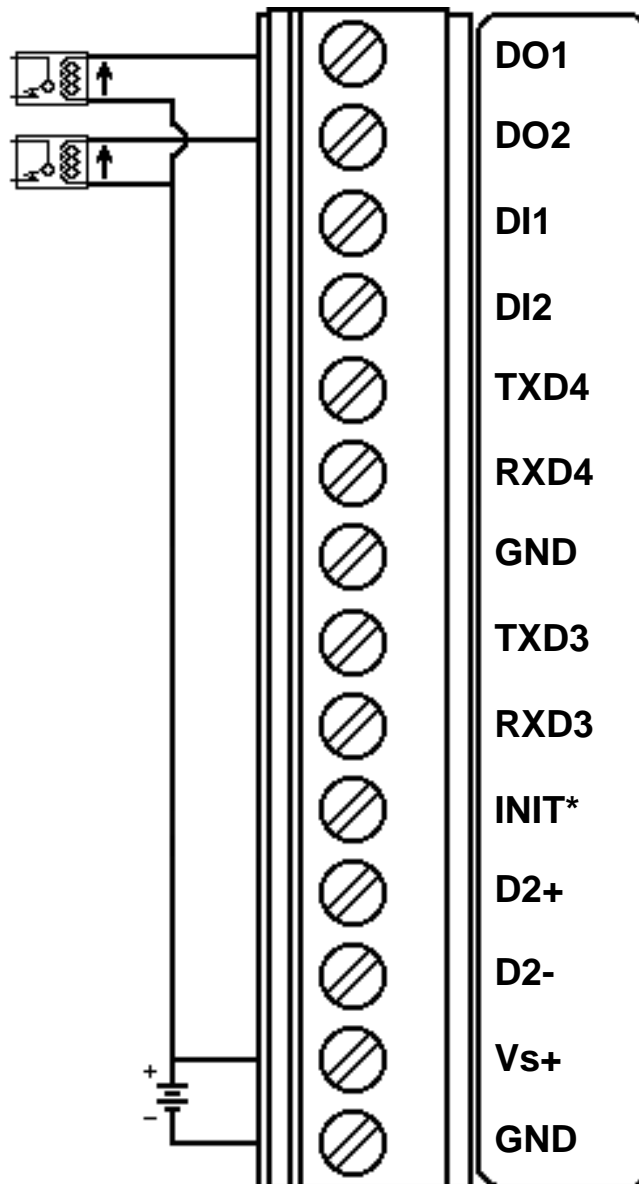

---

The sample code for retrieving and setting DI and DO is as follows.

```
int Do1, Do2

InitLib(); /* Initiate the 7188xa library */

Print("DI1=%s\n\r", GetDi1()?"High":"Low"); /* Read the state of DI1 */
Print("DI2=%s\n\r", GetDi2()?"High":"Low"); /* Read the state of DI2 */

Do1=GetDo1(); /* Read the state of DO1 */
Print("DO1=%s\n\r", Do1?"High":"Low");
if(!Do1)
    SetDo1On(); /* Set the DO1 to ON */
else
    SetDo1Off(); /* Set the DO1 to OFF */

Do2=GetDo2(); /* Read the state of DO2 */
Print("DO2=%s\n\r", Do1?"High":"Low");
if(!Do2)
    SetDo2On(); /* Set the DO2 to ON */
else
    SetDo2Off(); /* Set the DO2 to OFF */
```

Refer to the demo programs in the  
CD:\Napdos\7188XABC\7188XA\Demo\BC\_TC\IO\_Pin folder for more  
information.



---

## 4.12 Using the I/O Expansion Bus

As there are many serial interface devices available today, the I/O expansion bus includes both serial and parallel interfaces. The parallel interface is very similar to an ISA bus, so the old ISA bus design can be migrated to the I/O expansion bus with a minimum amount of alteration. The I/O pins of the serial bus are programmable and can be programmed as either D/I or D/O.

The features of these serial devices are as follows:

- Smaller size compared to parallel devices
- Lower cost compared to parallel devices
- Easier to design for isolated applications

The serial interface of the I/O expansion bus makes connecting to these serial devices very easy.

### 4.12.1 Definition of an I/O Expansion Bus

The I/O expansion bus of the I-7188XA(D) module can be divided into 3 groups as follows:

1. Power supply and reset signals: VCC, GND, RESET and /RESET
2. Parallel Bus:
  - System clock: CLOCKA
  - Asynchronous ready control: ARDY
  - Address bus: A0 ~ A7
  - Data bus: D0 ~ D7
  - Interrupt control: INT0, INT1 and INT4
  - Chip select and read/write strobe: /CS, /WR and /RD
3. Serial Bus: TO\_0, TO\_1, TI\_0, TI\_1, SCLK, DIO9, DIO4 and DIO14

The definition of an I/O expansion bus is given as follows:

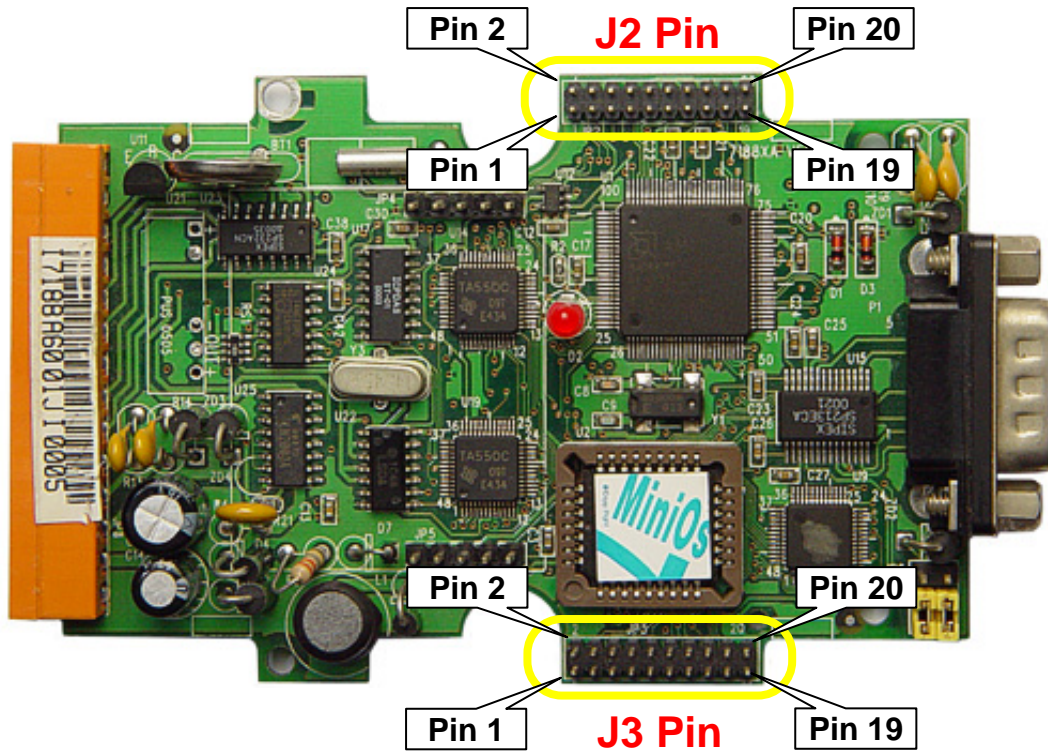

J2 pin definition and description:

No	Name	Description
1	GND	PCB ground
2	GND	PCB ground
3	CLOCKA	CPU synchronous clock output
4	ARDY	Asynchronous ready input (level sensitive, OPEN=ready)
5	INT0	Channel 0 interrupt request input (asynchronous, active high)
6	INT1	Channel 1 interrupt request input (asynchronous, active high)
7	VCC	PCB power supply
8	RESET	Power-up reset pulse (active high)
9	GND	PCB ground
10	/RESET	Power up reset pulse (active low)
11	TO_0	CPU Timer output 0 (can be used as a programmable D/I/O)
12	TO_1	CPU Timer output 1 (can be used as a programmable D/I/O)
13	TI_0	CPU Timer input 0 (can be used as a programmable D/I/O)
14	TI_1	CPU Timer input 1 (can be used as a programmable D/I/O)
15	SCLK	Common serial clock output for 7188 series modules
16	DIO9	Programmable D/I/O bit
17	DIO4	Programmable D/I/O bit
18	DIO14	Programmable D/I/O bit
19	VCC	CPU power supply
20	VCC	CPU power supply

- **CLOCKA:** 40M
- **ARDY:** This pin is left OPEN for applications that do not require the use of wait states
- **INT0 and INT1:** These two pins are left OPEN for that do not require an interrupt applications
- **TO\_0 and TO\_1:** These pins can be used as the timer output of the CPU or programmable DI/O
- **TI\_0 and TI\_1:** These pins can be used as the timer input of the CPU or programmable D/I/O
- **DIO4, DIO9 and DIO14:** Programmable DI/O bit
- **SCLK:** The I-7188XA(D) uses this signal as a CLOCK source to drive all onboard serial devices so it is always programmed as DO. Changing this signal to other configurations will cause serious errors. This signal to drive external serial can be used devices without any side effects.

### J3 pin definition and description:

No	Name	Description
1	A0	Address bus
2	D0	Data bus
3	A1	Address bus
4	D1	Data bus
5	A2	Address bus
6	D2	Data bus
7	A3	Address bus
8	D3	Data bus
9	A4	Address bus
10	D4	Data bus
11	A5	Address bus
12	D5	Data bus
13	A6	Address bus
14	D6	Data bus
15	A7	Address bus
16	D7	Data bus
17	INT4	Interrupt request input for channel 4 (asynchronous, active high)
18	/WR	Write strobe output (synchronous, active low)
19	/CS	Chip select output (synchronous, active low)
20	/RD	Read strobe output (synchronous, active low)

- **Address bus (output):** A0 ~ A7
- **Data Bus (tri-state, bi-direction):** D0 ~ D7
- **INT4:** This pin is left OPEN for applications that do not require an interrupt
- **/CS, /RD and /WR:** These 3 signals will be synchronous to CLOCKA (Pin3 of JP2) and asynchronous to ARDY (Pin4 of JP2)
- The /CS will be active if the program needs to input/output data from I/O address 0 to 0xff.

**Note:** Refer to “I/O Expansion Bus for 7188X/7188E User’s Manual” for more information.

### 4.12.2 I/O Expansion Boards

I/O Expansion Boards for prototyping and testing:

Board	Description
X000	Prototype Board (Small size)
X001	Prototype Board (Large size)
X003	Self-test

I/O Expansion Boards for DI and DO:

Board	Description
X119	7 DI channels + 7 DO channels (Without case)

I/O Expansion Boards for RS-232

Board	Description
X500	1 9-wire RS-232 channel (Without case)
X560	3 3-wire RS-232 channels + 8M bytes NAND Flash (Without case)

I/O Expansion Boards for storage devices:

Board	Descriptions
X600	4M bytes NAND Flash
X601	8M bytes NAND Flash
X607	128K battery backup SRAM
X608	512K battery backup SRAM

**Note:** Refer to “I/O Expansion Bus for 7188X/7188E User’s Manual” for more information.

# 5. Applications

## 5.1 Embedded Controllers

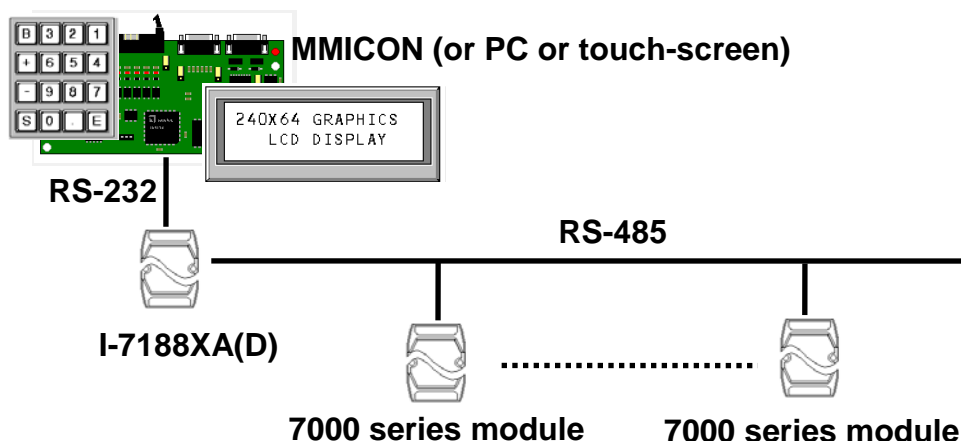

### Applications:

- 4500 replacement and enhancement (not compatible)
- PC-based controller replacement
- PLC replacement
- Special controller replacement

The I-7188XA(D) can be used as an embedded controller for general applications, meaning that it can be used to replace a Host PC, PLC or other special controllers.

Programming Tool	TC/BC/MSC
Debug Tool	Via standard input/output (keyboard and monitor of a Host PC)
Man Machine Interface	<ul style="list-style-type: none"> <li>● MMICON</li> <li>● PC keyboard and monitor</li> <li>● Touch Screen (RS-232 or RS-485 interface)</li> </ul>
Program	Stored in Flash Memory
Input/Output	<ul style="list-style-type: none"> <li>● Onboard DI or DO</li> <li>● From an I/O Expansion Bus</li> <li>● 7000 series modules can directly control up to 256 modules giving thousands of I/O points</li> </ul>

## 5.2 Local Real Time Controller (RTC)

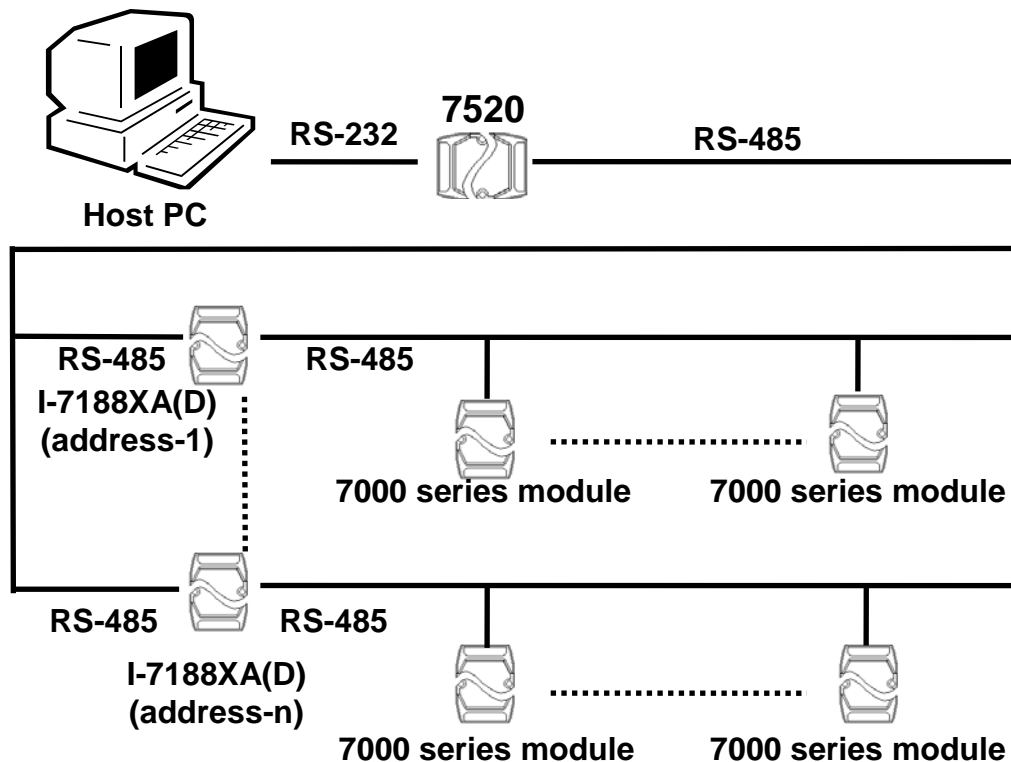

In this configuration, the 7000 series modules act as slave devices. The control programs are implemented in the Host PC. The operation steps are as follows:

- The PC sends commands to the 7000 series modules and receives some input data.
- The PC analyzes this input data and generates some output data
- The PC sends commands to the 7000 series modules as output data

If there are hundreds of 7000 series modules, it will take the Host PC a long time to analyze and control these modules, so the control program can be implemented in a local I-7188XA(D). The PC then only has to send control arguments to the I-7188XA(D), and the I-7188XA(D) will control the local 7000 series modules based on these control arguments. In this way, thousands of 7000 series modules can be controlled by the PC via the I-7188XA(D).

Some control functions are timing-critical, so the local I-7188XA(D) can handle these functions in real time without the need for control by Host PC.

---

## 5.3 Remote Local Controller

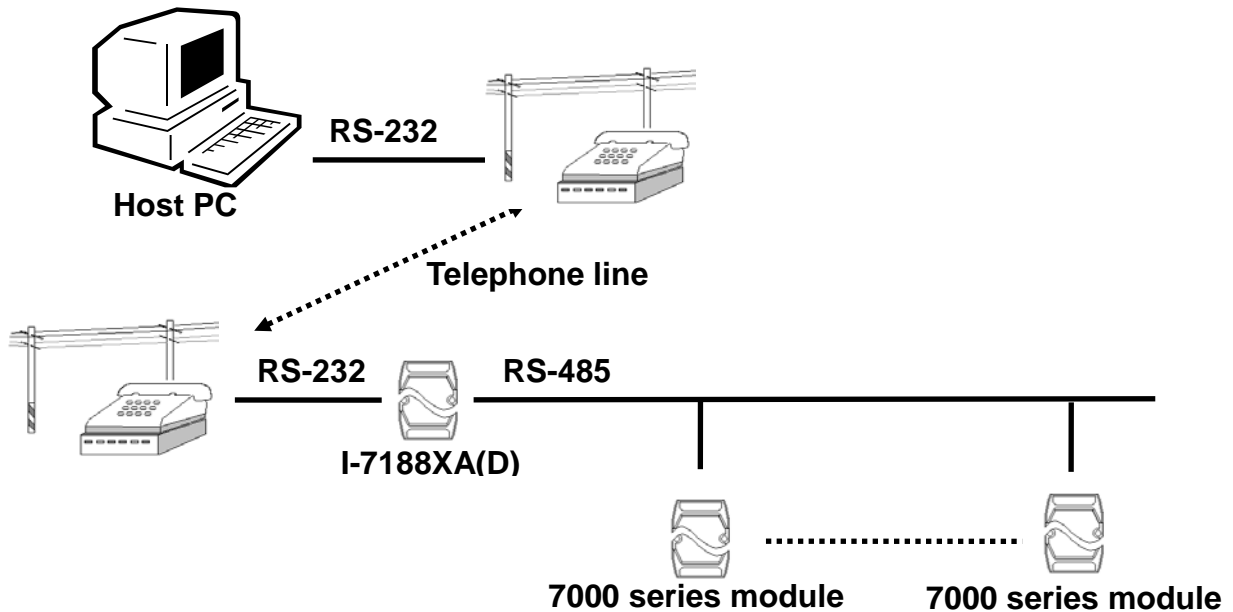

In this configuration, the control program is implemented series a local I-7188XA(D). The I-7188XA(D) will directly control the 7000 series modules based on these control arguments.

The Host PC can then access the remote I-7188XA(D) regarding the following items:

- Query and record the status of the remote system
- Download control arguments to the remote I-7188XA(D)

The remote I-7188XA(D) can communicate with the Host PC regarding the following items:

- Emergency event notification and response
- Remote system status notification

## 5.4 PLC I/O Expansion Application

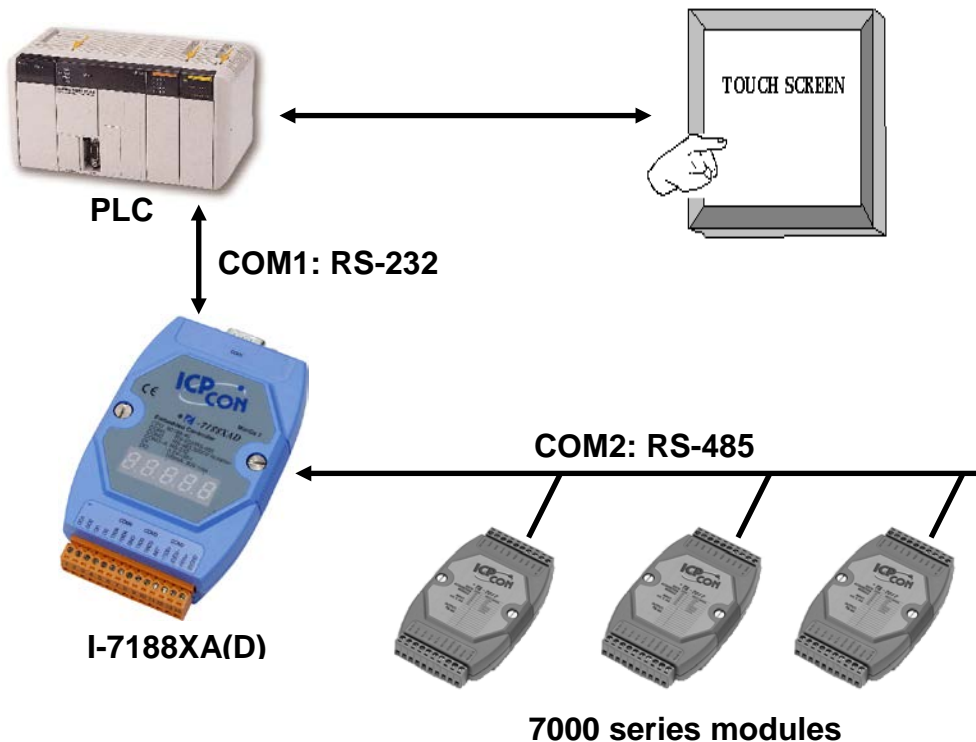

Most PLCs contain a Man Machine Interface that was originally designed for MMI applications. The I-7188XA(D) can use this interface to construct a bridge between a PLC and the 7000 series modules.

The I-7188XA(D) can directly read/write from/to the internal memory of the PLC, meaning that the PLC can access the 7000 series input modules as follows:

- The I-7188XA(D) sends a command to the 7000 series input modules
- The I-7188XA(D) writes this data to the internal memory of the PLC
- The PLC accesses this data from its internal memory

The PLC can control the 7000 series output modules as follows:

- The PLC writes data to its internal memory
- The I-7188XA(D) reads the output data from the memory of the PLC
- The I-7188XA(D) sends a command to its 7000 output modules



---

In this way, the input data from the 7000 series modules can be displayed on a touch screen. In addition the output from the 7000 series modules can be controlled from a touch screen.

## 5.5 Radio Modem Application

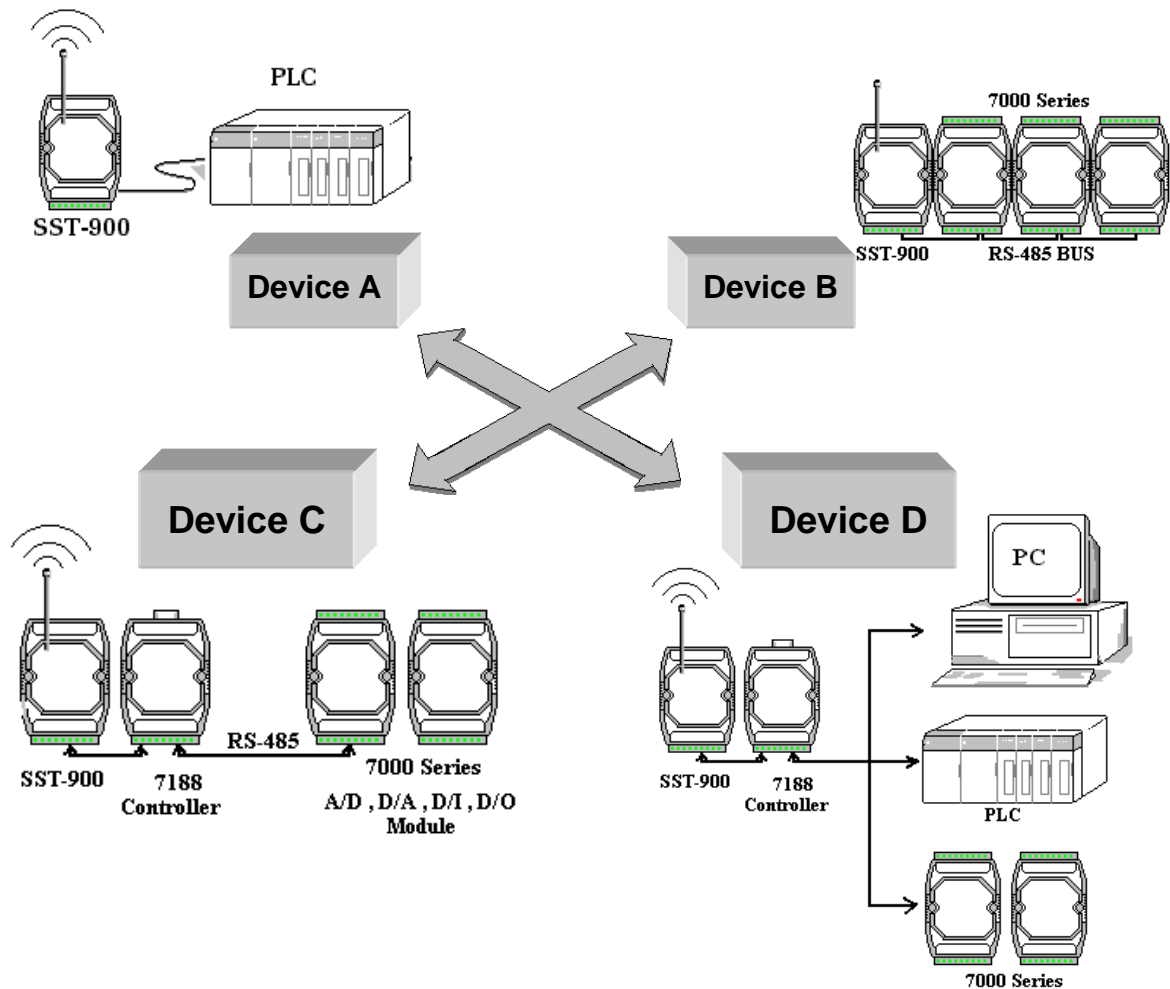

### SST-900/SST-2400 settings: (Device A)

- RS-232
- Half-duplex mode
- Synchronous way
- Slave state
- Baud Rate=9600
- Channel=3
- Frequency=915.968MHz

### SST-900/SST-2400 settings: (Device B/C/D)

- RS-485 or RS-232
- Half-duplex mode
- Synchronous way
- Slave state

- 
- Baud Rate=9600
  - Channel=3
  - Frequency=915.968MHz

As the I-7188XA(D) is an embedded controller, and is programmable, **it can be used as a bridge between the SST-900 and any external devices**, such as a PLC, a controller or other 7000 series modules.

## 5.6 An Application Using 4 COM Ports (1)

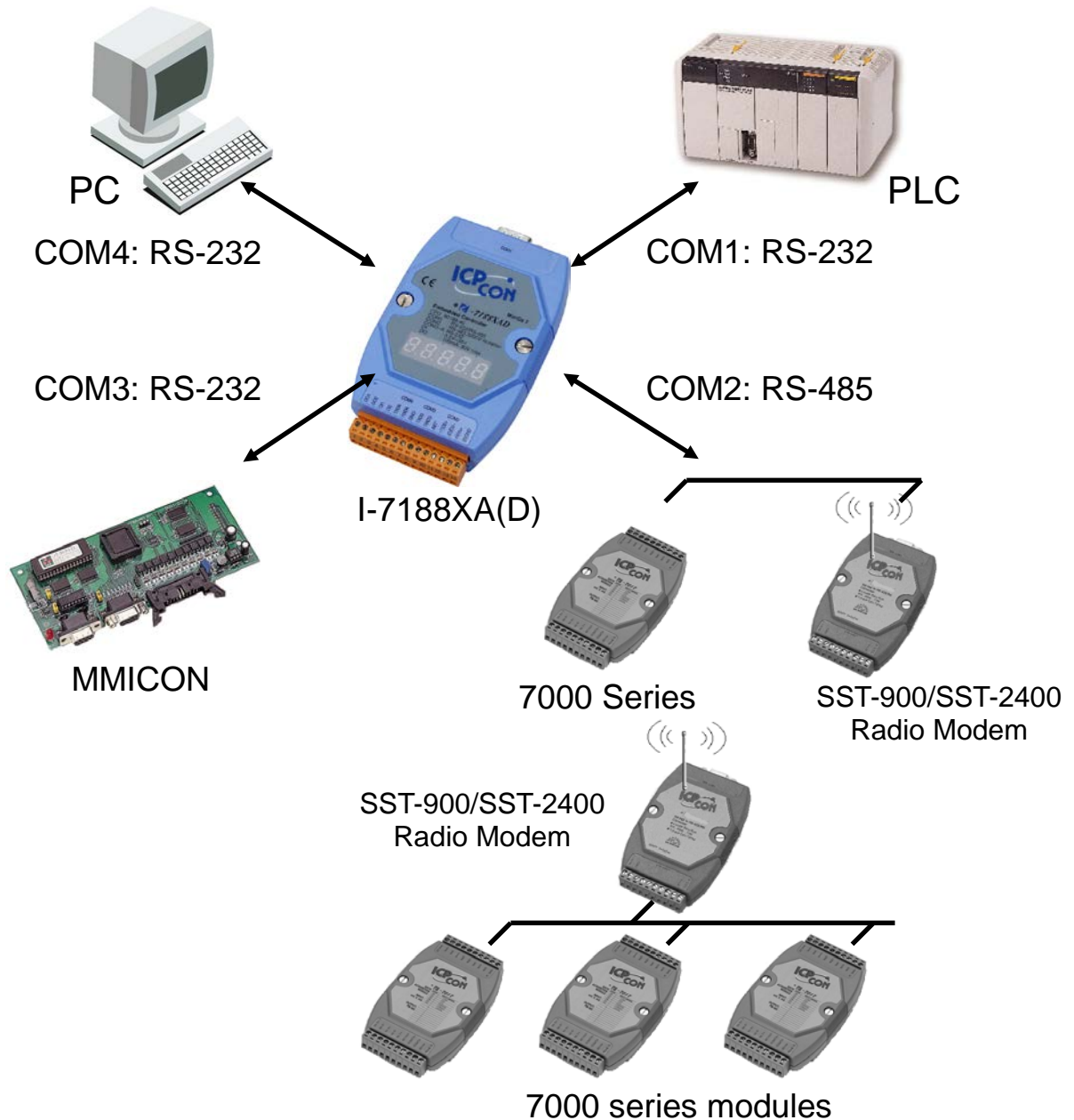

- COM1: The PLC can access the I/O state of the 7000 series modules
- COM2: Directly controls the 7000 series input/output modules
- COM3: MMICON is used as the local MMI
- COM4: The PC is used to monitor and record the system data.

## 5.7 An Application Using 4 COM Ports (2)

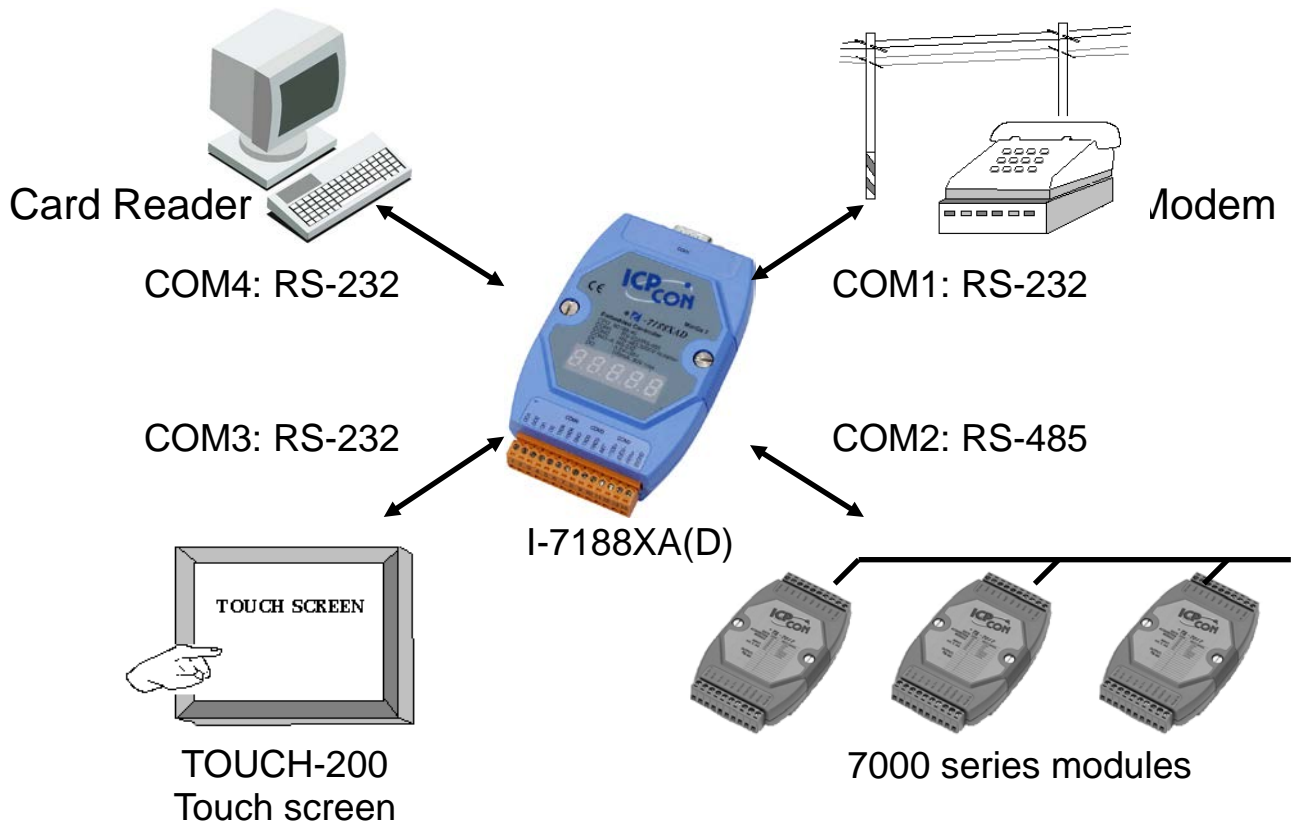

COM1: Links to the remote Host PC

COM2: Directly controls the 7000 series input/output modules

COM3: The TOUCH-200 is used as the local MMI

COM4: The Card reader is used as a standard input device.

---

# Appendix A: What is MiniOS7

MiniOS7 is an embedded operating system developed by ICP DAS Co., Ltd. that is designed to replace ROM-DOS in 7188 series modules. Various companies have created several brands of DOS. In all cases, DOS (whether PC-DOS, MS-DOS or ROMDOS) is a set of commands or code that tells the computer how to process information. DOS runs programs, manages files, controls information processing, directs input and output, and performs many other related functions.

**MiniOS7 provides all equivalent functions of ROM-DOS while, in addition, providing user specific functions for the I-7188XA(D).**

Below is a comparison table between MiniOS7 and ROM-DOS as follows:

	<b>MiniOS7</b>	<b>ROM-DOS</b>
Power-up time	0.1 sec	4 ~ 5 sec
More compact size	<64K bytes	64K bytes
Support for I/O Expansion Bus	Yes	No
Support for ASIC Key	Yes	No
Flash ROM management	Yes	No
O.S. update (download)	Yes	No
Built-in hardware diagnostic functions	Yes	No
Direct control of 7000 series modules	Yes	No
Customer ODM functions	Yes	No
Free of charge	Yes	No

**Note:** ICP DAS reserves the right to change the specifications of MiniOS7 without notice.

The typical command set for MiniOS7

<b>Command</b>	<b>Description</b>
LED5 pos value	Displays a HEX value in the specified position of 5-digit LED
USE NVRAM	Accesses the service routine to read/write from/to the NVRAM
USE EEPROM	Accesses the service routine to read/write from/to the EEPROM

USE FLASH	Accesses the service routine to read/write from/to the Flash Memory
USE COM2 /option	Accesses the service routine to send/receive to/from COM2
DATE [mm/dd/yyyy]	Sets the date of the RTC
Time [hh:mm:ss]	Sets the time of the RTC
MCB	Tests the current memory block
UPLOAD	Stores the MiniOS7 image file in the SRAM of the I-7188XA(D) (this command is only used to upgrade MiniOS7)
BIOS1	Stores the MiniOS7 image file in the Flash memory of the I-7188XA(D) (this command only used to upgrade MiniOS7)
LOAD	Downloads the user program file to the Flash Memory of the I-7188XA(D)
DIR [/crc]	Lists the information of all files stored in the Flash Memory of the I-7188XA(D)
RUN fileno	Executes the file with the prescribed file number
Filename	Executes the file with the prescribed file name
DELETE or DEL	Deletes all files stored in the Flash Memory.
RESET	Resets the CPU
DIAG [option]	Performs hardware diagnostics
BAUD baudrate	Sets a new value for the Baud Rate of COM1
TYPE filename [/b]	Lists the contents of a file
REP [#] command	Repeats the execution of the same command # times
RESERVE [n]	Reserve n Flash Memory sectors for a program file
LOADR	Downloads files to the SRAM
RUNR [option]	Runs the program stored in the SRAM of the I-7188XA(D) (downloaded using the LOADR command)
I/INP/IW/INPW port	Reads data from the hardware Port
O/OUTP/OW/OUTPW port value	Outputs data to the hardware Port
More .....	

**Note:** For more detailed information regarding MiniOS7, please refer to CD:\Napdos\MiniOS7\document\Lib\_Manual\_For\_7188XABC\index.htm or

---

[http://ftp.icpdas.com/pub/cd/8000cd/napdos/minios7/document/lib\\_manual\\_for\\_7188xabc/index.htm](http://ftp.icpdas.com/pub/cd/8000cd/napdos/minios7/document/lib_manual_for_7188xabc/index.htm)



---

## Appendix B: MiniOS7 Utility and 7188XW

Both the MiniOS7 Utility and 7188xw.exe application will allow users to easily upgrade to the latest version of MiniOS7. The MiniOS7 Utility and 7188xw.exe application can be used to perform essential configuration functions and for downloading programs to the MiniOS7 embedded in the I-7188XA(D) controller.

### MiniOS7 Utility

The MiniOS7 Utility program provides three main functions:

- Upgrade the MiniOS7 image
- Download program files to the Flash Memory
- Configure the COM port settings

### MiniOS7 utility location

The MiniOS7 utility is located in the CD:\NAPDOS\MINIOS7\UTILITY\MiniOS7\_utility folder on the CD or at [http://ftp.icpdas.com/pub/cd/8000cd/napdos/minios7/utility/minios7\\_utility/](http://ftp.icpdas.com/pub/cd/8000cd/napdos/minios7/utility/minios7_utility/) on the web

### Installation procedure

Step 1: Locate and execute **minios7\_utility\_v311.exe** from the **CD:\Napdos\MiniOS7\utility\MiniOS7\_utility\** folder.

Step 2: After completing the installation, a new folder, **ICPDAS**, will be added to the **programs** section of the start menu. Clicking on this folder will allow access to the MiniOS7 Utility files. See the diagram below for details.

1

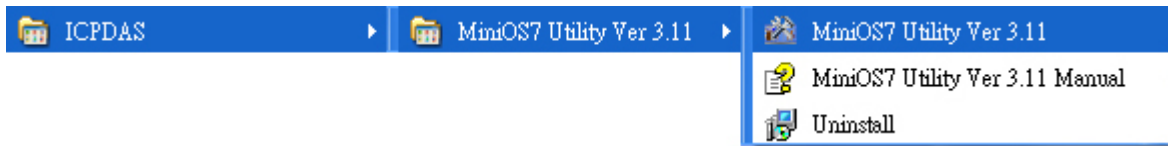

2

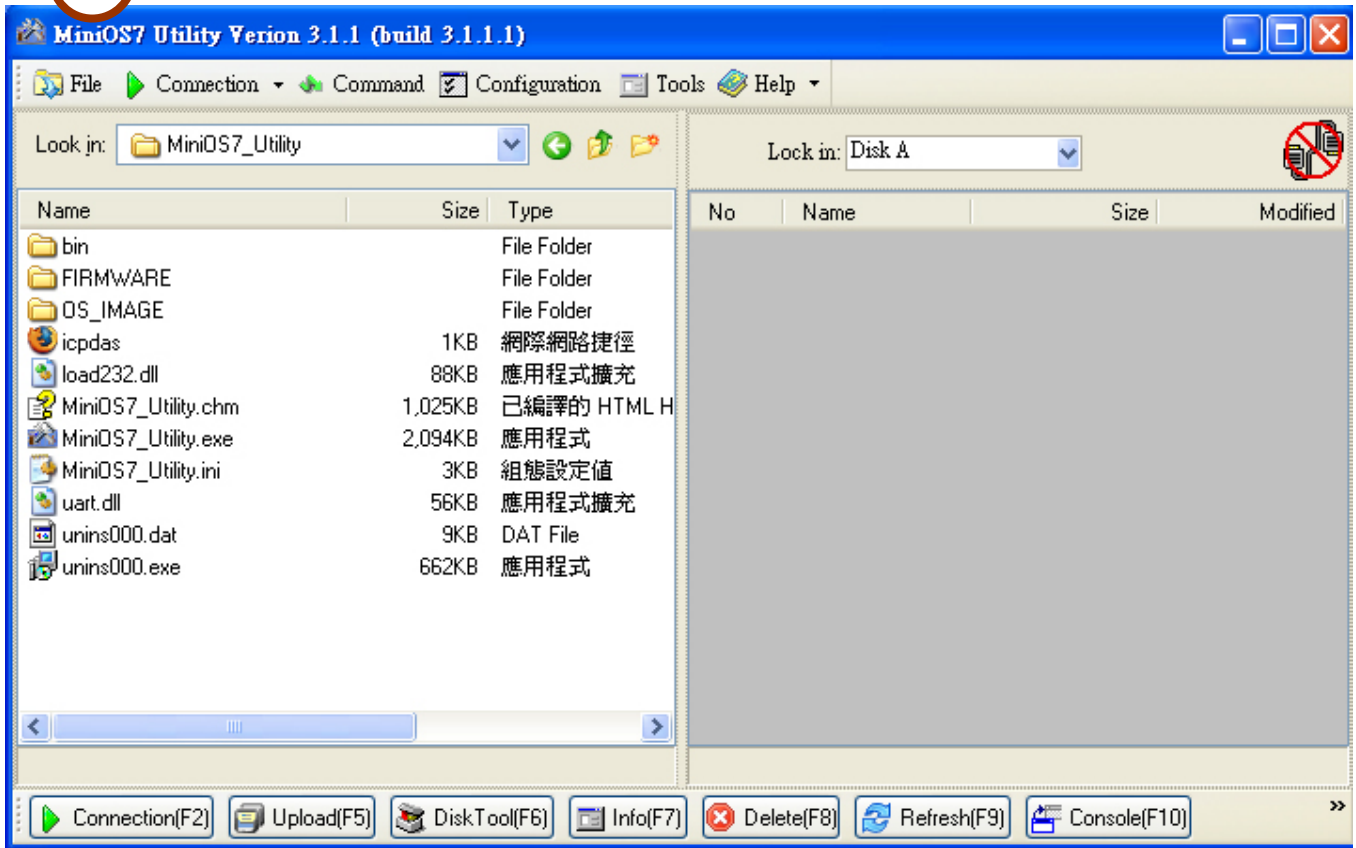

---

# 7188XW

The 7188xw.exe application is the main utility for the I-7188XA(D), and can be used to perform the following functions:

- **Download user program files from a Host PC into the memory unit of the I-7188XA(D) module.**
- **Download the MiniOS7 image file from a Host PC into the Flash Memory of the I-7188XA(D) controller and upgrade the MiniOS7.**
- **Show a debug string on the monitor of a Host PC**  
Three standard output library functions, such as Putch function, Print and Puts, will allow a main control unit to send an output string to the monitor of a Host PC.
- **Enter data into I-7188XA(D) module using the Host PC keyboard**  
Three standard input library functions, such as Getch, Scanf and LineInput, will allow the main control unit to read keyboard input from a Host PC.

## 7188xw.exe location

The 7188xw.exe is located in the CD:\Napdos\MiniOS7\utility\ folder or at <http://ftp.icpdas.com/pub/cd/8000cd/napdos/minios7/utility/> on the web.

## 7188xw.exe command line options for MiniOS7

Option	Description
/c#	Uses COM# of the Host PC
/b#	Sets the Baud Rate for the COM port on the Host PC (default is 115200)
/s#	Sets the number of display rows on the screen (default is 25, max. is 50)

## 7188xw.exe Hot-key

Command	Description
F1	Shows the 7188xw.exe help messages
Alt_F1	Shows the 7188xw.exe help messages using the Chinese (Big5) character set
Ctrl_F1	Shows the 7188xw.exe help messages using the Chinese (GB2312) character set

Alt_1	Uses COM1 on the Host PC
Alt_2	Uses COM2 on the Host PC
Alt_3	Uses COM3 on the Host PC
Alt_4	Uses COM4 on the Host PC
Alt_5	Uses COM5 on the Host PC
Alt_6	Uses COM6 on the Host PC
Alt_7	Uses COM7 on the Host PC
Alt_8	Uses COM8 on the Host PC
Alt_9	Uses COM9 on the Host PC
Alt_A	Switches between normal mode and ANSI-Escape-code-support mode
Alt_C	Switches to command mode. Supports commands: b#: Sets a new Baud Rate for the COM ports on the Host PC c#: Uses COM# on the Host PC n/e/o: Sets the parity to none/even/odd 5/6/7/8: Sets the data bits to 5/6/7/8 p#: Sets working directory of the Host PC q: Quits command mode
Alt_D	Sets the date of the RTC to the date on the Host PC
Alt_T	Set the time of the RTC to the time on the Host PC
Alt_E	Used to download a file to memory. Alt_E should be pressed only after the "Press ALT_E to download file!" message is shown on the screen.
Alt_H	Toggles between Hex/ASCII display mode
Alt_L	Toggles between normal/line mode. In line mode, all characters pressed will not be sent to the COM Port until the ENTER key is pressed, and it is designed for testing 7000 series modules
Alt_X	Quits the 7188xw.exe application
F2	Sets the file name for downloading (without initiating a download operation)
F5	Runs the program specified by F2 and arguments set by F6
F6	Sets the arguments of the execution file set by F2. (10 arguments maximum. If set to less than 10 arguments, add '*' to end)
Ctrl_F6	Clears the screen
F8	F8=F9+F5
F9	Downloads the file specified by F2 to the FLASH memory
Alt_F9	Downloads all files specified by ALT_F2 to the FLASH memory

F10	Downloads the file specified by F2 to the SRAM and executes it
Alt_F10	Downloads all files specified by ALT_F2 to the SRAM memory
Ctrl_B	Sends a BREAK signal to the COM port of the Host PC that is currently being used by 7188xw.exe
More...	

For more detailed information regarding the 7188xw.exe application, please refer to the index.htm file in the CD:\Napdos\MiniOS7\document\Lib\_Manual\_For\_7188XABC\ folder or at [http://ftp.icpdas.com.tw/pub/cd/8000cd/napdos/minios7/document/lib\\_manual\\_for\\_7188xabc/](http://ftp.icpdas.com.tw/pub/cd/8000cd/napdos/minios7/document/lib_manual_for_7188xabc/) on the web.

### Downloading a file to the I-7188XA(D) controller using the 7188xw.exe application

Step 1: Power-off the I-7188XA(D). Connect the INIT\* pin to the GND pin and power-on the I-7188XA(D) at the same time.

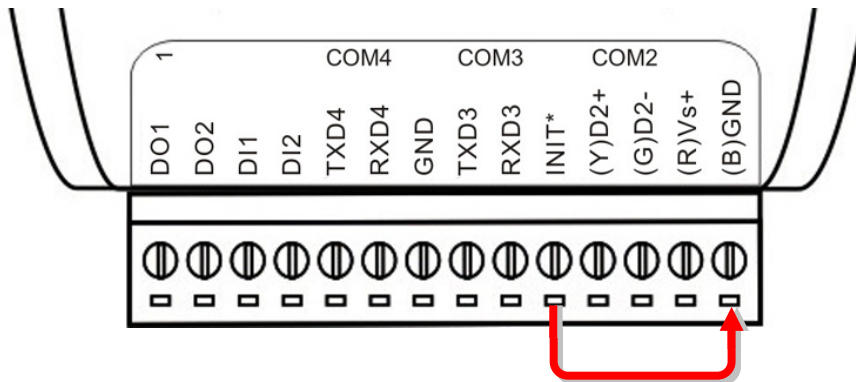

Step 2: After the I-7188XA(D) has been switched on, disconnect the INIT\* pin from the GND pin.

Step 3: Open an MS-DOS command prompt window using the steps shown bellow.

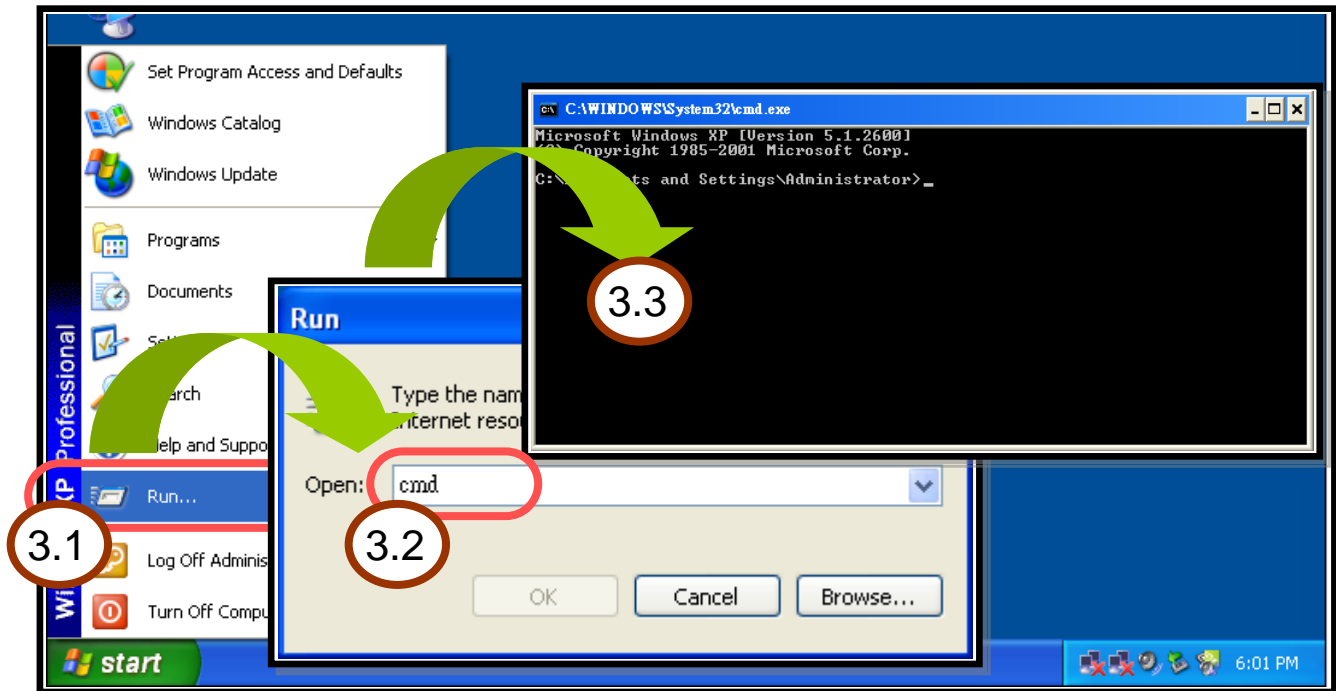

Step 4: Type “cd c:\7188XA\Demo\BC\_TC\Hello\Hello\_C\” then press **<Enter>**. (Assume user copy the 7188XA folder to C drive letter. Refer to Step2 in Sec.2.1)

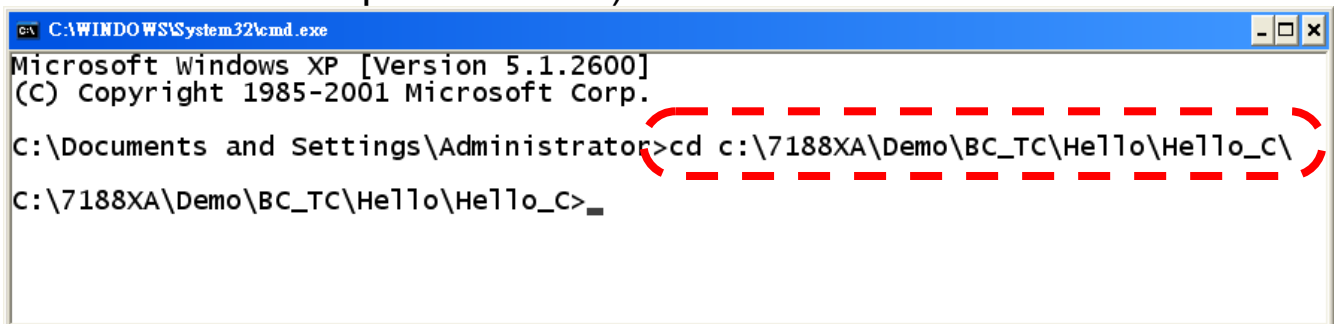

Step 5: Execute the **7188xw.exe** application as shown in the following figure.

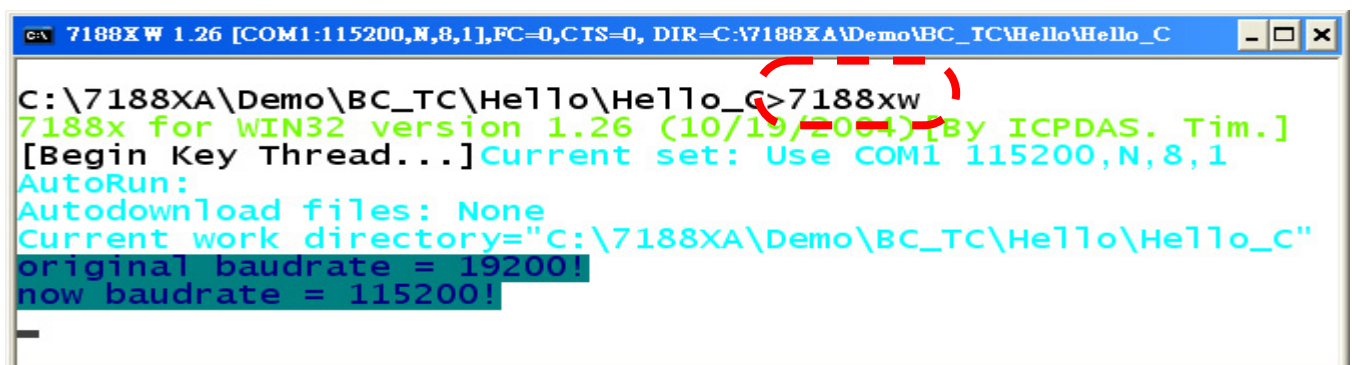

Step 6: Press <F2> and then type the filename “Hello.exe” and press <Enter>.

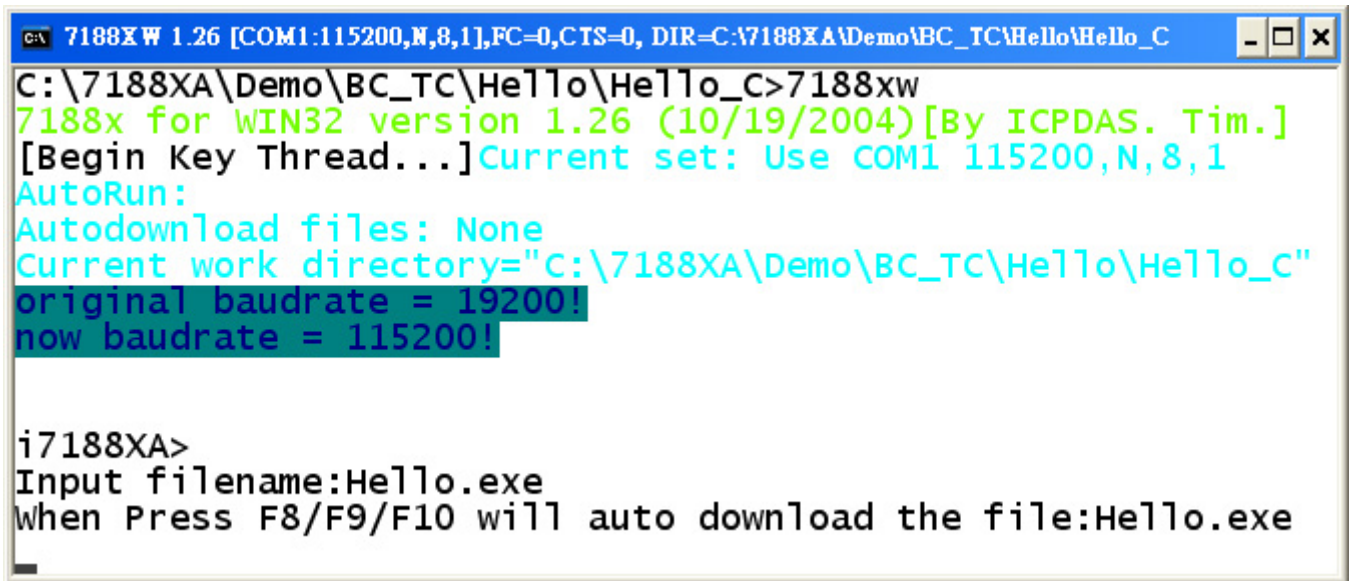

```
C:\7188XA\Demo\BC_TC\Hello\Hello_C>7188xw
7188x for WIN32 version 1.26 (10/19/2004)[By ICPDAS. Tim.]
[Begin Key Thread...]Current set: Use COM1 115200,N,8,1
AutoRun:
Autodownload files: None
Current work directory="C:\7188XA\Demo\BC_TC\Hello\Hello_C"
original baudrate = 19200!
now baudrate = 115200!

i7188XA>
Input filename:Hello.exe
When Press F8/F9/F10 will auto download the file:Hello.exe
```

Step 7: Press <F8> to download the Hello.exe file to the I-7188XA(D) and execute the program.

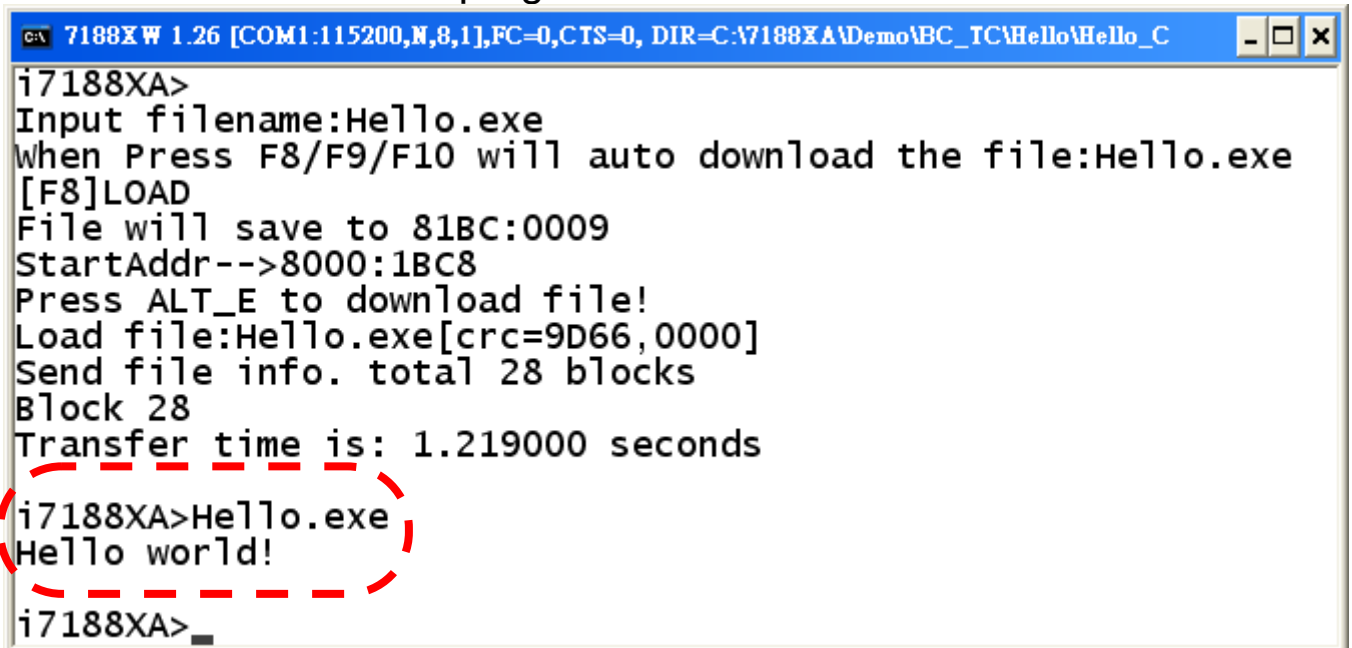

```
i7188XA>
Input filename:Hello.exe
When Press F8/F9/F10 will auto download the file:Hello.exe
[F8]LOAD
File will save to 81BC:0009
StartAddr-->8000:1BC8
Press ALT_E to download file!
Load file:Hello.exe[crc=9D66,0000]
Send file info. total 28 blocks
Block 28
Transfer time is: 1.219000 seconds
i7188XA>Hello.exe
Hello world!
i7188XA>_
```

**Notes:** A description of the Hotkey functions is as follows:

F8: Download a file to FLASH Memory, and then execute the program

F9: Download a file to FLASH Memory.

F10: Download a file to SRAM, and then execute the program.

Step 8: Type “dir” and press <Enter> to check that the files are stored in the Flash Memory of the I-7188XA(D).



```
C:\7188XW 1.26 [COM1:115200,N,8,1],FC=0,CTS=0, DIR=C:\7188XA\Demo\BC_TC\Hello\Hello_C
i7188XA>dir
0)Hello.exe      05/24/2006 17:53:23   7081[01BA9]8002:0000-81BC:0009
Total File number is 1  Free space=451607 bytes
i7188XA>_
```

Step 9: Type “del /y” and press <Enter> to delete all files stored in the Flash Memory of the I-7188XA(D).

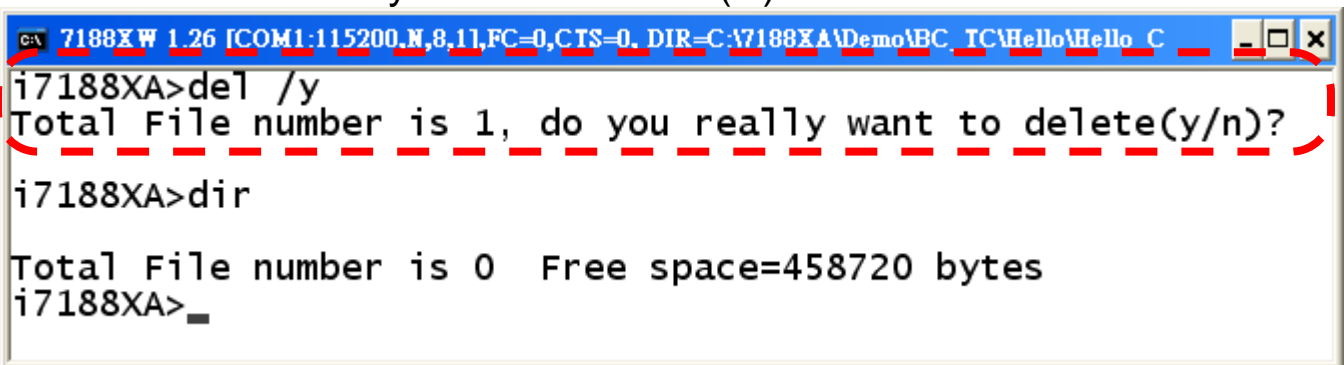

```
C:\7188XW 1.26 [COM1:115200,N,8,1],FC=0,CTS=0, DIR=C:\7188XA\Demo\BC_TC\Hello\Hello_C
i7188XA>del /y
Total File number is 1, do you really want to delete(y/n)?
i7188XA>dir
Total File number is 0  Free space=458720 bytes
i7188XA>_
```

**Note:** The MiniOS7 only supports the **delete all** command. Individual files cannot be selected for deletion.

Step 10: Press <Alt + X> to quit the MiniOS7.

### Upgrading MiniOS7 using the 7188xw.exe application

Step 1: Connect the I-7188XA(D) to the COM Port of the Host PC using the CA0910 cable. Refer to the wiring diagram in Section 2.2 for details.

Step 2: Determine the latest version of the MiniOS7 image file.

The format of the image file name is: **TTYMMDD.img**

**TT**: TYPE of product.

**YY**: Year that this image was released

**MM**: Month that this image was released

**DD**: Day that this image was released



**Note:** The MiniOS7 image file can be found in the CD:\NAPDOS\MiniO7\ directory on the companion CD. The latest MiniOS7 version can be downloaded from:  
[http://ftp.icpdas.com/pub/cd/8000cd/napdos/7188xabc/7188xa/os\\_image/](http://ftp.icpdas.com/pub/cd/8000cd/napdos/7188xabc/7188xa/os_image/)

Step 3: From the Host PC, go to the directory where the image file is stored, then execute the 7188xw.exe application to connect the Host PC to the I-7188XA(D) controller.

Step 4: Use the “**UPLOAD**” command, then press <ALT + E> after the “Press ALT\_E to download file!” message is shown on the screen.

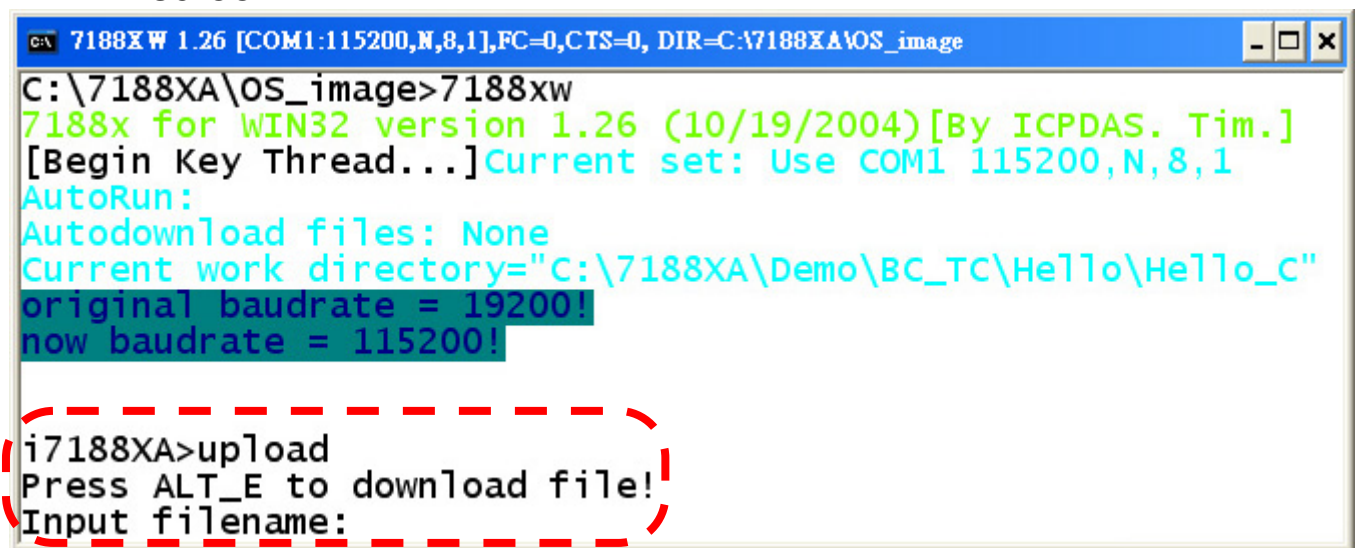

```
C:\7188XA\OS_image>7188xw
7188x for WIN32 version 1.26 (10/19/2004)[By ICPDAS. Tim.]
[Begin Key Thread...]Current set: Use COM1 115200,N,8,1
AutoRun:
Autodownload files: None
Current work directory="C:\7188XA\Demo\BC_TC\Hello\Hello_C"
original baudrate = 19200!
now baudrate = 115200!

i7188XA>upload
Press ALT_E to download file!
Input filename:
```

Step 5: Type the image filename (for example: xa050701.img) then press <ENTER>.

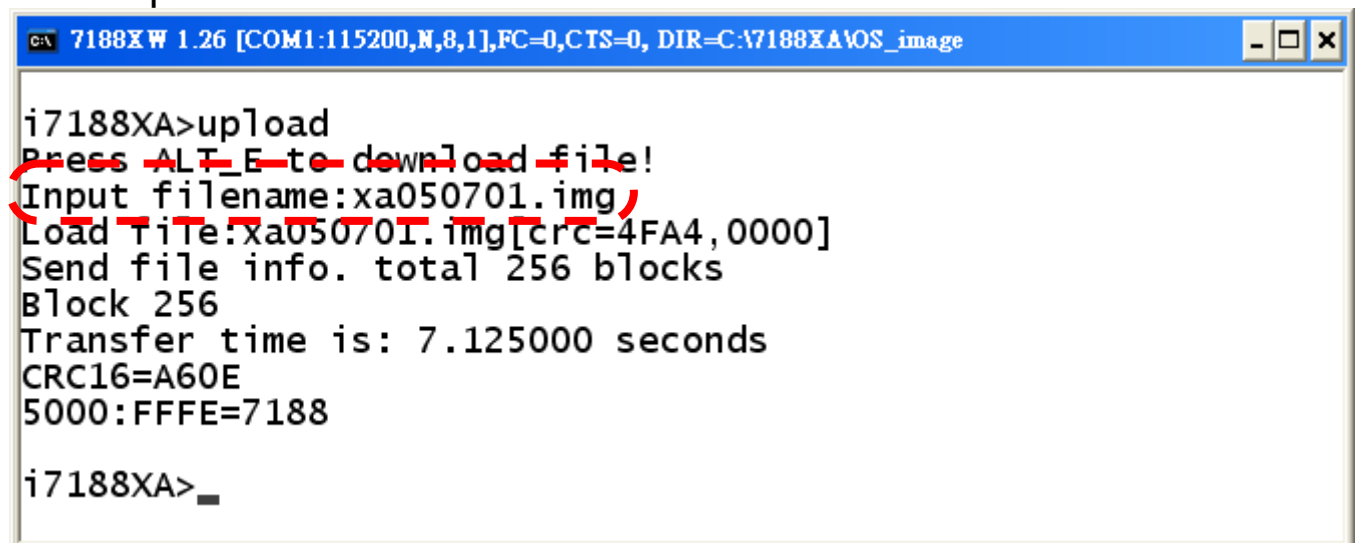

```
i7188XA>upload
Press ALT_E to download file!
Input filename:xa050701.img)
Load file:xa050701.img[crc=4FA4,0000]
Send file info. total 256 blocks
Block 256
Transfer time is: 7.125000 seconds
CRC16=A60E
5000:FFFE=7188

i7188XA>_
```

Step 6: Wait for the upload to finish. (The image file will be stored in the SRAM.)

Step 7: Type the “**bios1**” command in the I-7188XA(D) command line. (The OS will check the image file stored in the SRAM, and then display the version information. If the image file is correct, it will be written to the Flash Memory.)

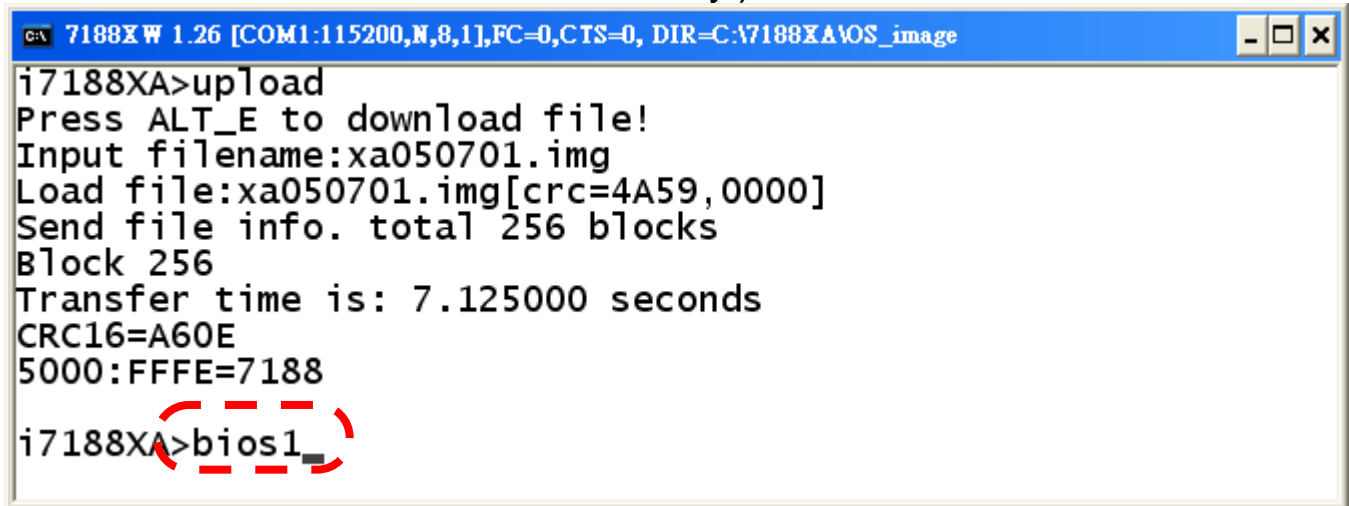

```
C:\ 7188XW 1.26 [COM1:115200,N,8,1],FC=0,CTS=0, DIR=C:\7188XA\OS_image
i7188XA>upload
Press ALT_E to download file!
Input filename:xa050701.img
Load file:xa050701.img[crc=4A59,0000]
Send file info. total 256 blocks
Block 256
Transfer time is: 7.125000 seconds
CRC16=A60E
5000:FFFE=7188
i7188XA>bios1
```

Step 8: It will take about 10 seconds to upgrade MiniOS7. After the update has finished, the system will automatically reboot. If this does not occur, the system must be rebooted manually.



```
C:\ 7188XW 1.26 [COM1:115200,N,8,1],FC=0,CTS=0, DIR=C:\7188XA\OS_image
i7188XA>bios1
MiniOs7 for 7188XA Ver 2.00.003, date=07/01/2005
Checking CRC-16...OK.
Update the OS code. Please wait the message <<Write Finished>>
Erase Flash [F000]
Write Flash
[FF]
<<Write Finished>>OK
wait WDT reset system...
i7188XA>
```

---

Step 9: Type the “**ver**” command to check the MiniOS7 version number.

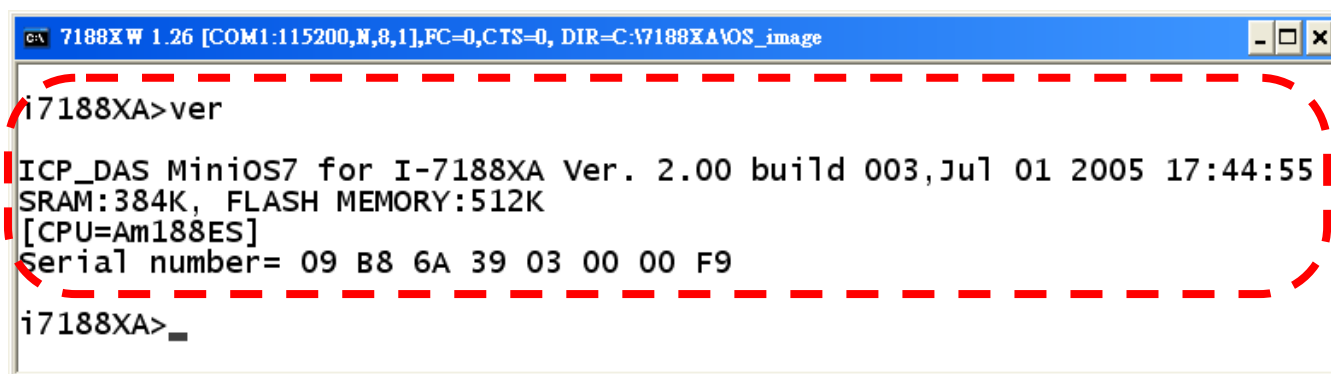

The screenshot shows a terminal window with a blue title bar containing the text "c:\ 7188XW 1.26 [COM1:115200,N,8,1],FC=0,CTS=0, DIR=C:\7188XA\OS\_image". The terminal content is as follows:

```
i7188XA>ver  
ICP_DAS Minios7 for I-7188XA Ver. 2.00 build 003, Jul 01 2005 17:44:55  
SRAM:384K, FLASH MEMORY:512K  
[CPU=Am188ES]  
Serial number= 09 B8 6A 39 03 00 00 F9  
i7188XA>_
```

A red dashed line is drawn around the output text in the terminal window.

# Appendix C: Comparison Table

Feature comparison table between the 7188 and the 7188X series:

	I-7188XA(D)	I-7188XB(D)	I-7188XC(D)	I-7188(D)
CPU clock	80188, 40MHz	80188, 40MHz	80188, 20MHz	80188, 40MHz
SRAM	512K	256K(I-7188XB) 512K(I-7188XB/512)	128K	256K
Flash Memory	512K	512K	256K (512K for ODM)	256K/512K
COM1	RS-232 with modem control or RS-485 with internal self-tuner	RS-232 or RS-485 with internal self-tuner	RS-232 or RS-485 with internal self-tuner	RS-232 with modem control or RS-485
COM2	RS-485 with internal self-tuner, 3000V isolation	RS-485 with self-tuner inside	RS-485 with self-tuner inside	RS-485
COM3	RS-232 (TxD, RxD)	No COM	No COM	RS-232 (TxD, RxD)
COM4	RS-232 (Txd, Rxd)	No COM	No COM	RS-232 (TxD, RxD)
User defined pins	0	14	3	0
Modem control	COM1	No	No	COM1
RTC	Yes	Yes	No	Yes
64-bit hardware unique serial number	Yes	Yes	No	No
EEPROM	2K bytes	2K bytes	2K bytes	2K bytes
D/I (3.5V~30V)	2 channels	1 channel	2 channels	0
D/O (100mA, 30V)	2 channels	1 channel	3 channels	0
I/O expansion bus	Yes	Yes	Yes	No
Support for ASIC Key	Yes	Yes	Yes	No
Operating system	MiniOS7	MiniOS7	MiniOS7	MiniOS7
Programming language	TC/MSC/BC	TC/MSC/BC	TC/MSC/BC	TC/MSC/BC
Program download Port	COM4	COM1	COM1	COM4

# Appendix D: Library Function List

The table below lists the most commonly used functions. For more details of all functions, refer to the instructions in the CD:\Napdos\MiniOS7\document\Lib\_Manual\_For\_7188XABC\index\_e.htm file or [http://ftp.icpdas.com/pub/cd/8000cd/napdos/minios7/document/lib\\_manual\\_for\\_7188xabc/index\\_e.htm](http://ftp.icpdas.com/pub/cd/8000cd/napdos/minios7/document/lib_manual_for_7188xabc/index_e.htm) on the web.



## Type 1: Standard IO

Function	Description
Kbhit	Checks if any keyboard input data is currently available in the input buffer of COM1.
Getch	Waits until a single character is received from keyboard input.
Ungetch	Returns a single character to the input buffer of COM1.
Putch	Sends a single character to COM1.
Puts	Sends a string to COM1.
Scanf	Retrieves formatted data such as scanf in the C language (Cannot used on MSC/VC++, only TC/BC)
Print	Prints formatted data such as printf in the C language.
ReadInitPin	Reads the status of the INIT* pin.
LineInput	Inputs a single line from StdInput.
...More...	There are more user functions for Standard IO. For more detailed information, please refer to the 7188xa.h file and CD:\Napdos\MiniOS7\document\Lib_Manual_For_7188XABC\index.htm

---

**Note:** The **Print** and **printCom** function cannot be used simultaneously in the same program.

- **Kbhit()**

Function: Checks whether any keyboard input data is currently available in the input buffer.

Syntax: **int Kbhit(void);**

Header: `#include "7188xa.h"`

Description: Checks if any data is currently available in the input buffer.

Return: 0: For no data input.

Other: There is data in the input buffer, and the return value is the next data in the buffer. If the next data is "\0", the function will return -1 (0xFFFF).

Example:

```
#include <7188xa.h>
void main()
{
    int quit=0, data;
    InitLib();
    Puts("\n\nPress any key to show ASCII ('Q' to quit):\n\n");
    while(!quit){
        if(Kbhit()){
            data=Getch();
            if(data=='Q') quit=1;
            Putch(data);
            Print(" ASCII is: %d\n\n", data);
            Puts("\n\nPress any key to show ASCII ('Q' to quit):\n\n");
        }
    }
}
```

- **Getch()**

Function: Waits until a character is received from keyboard input.

Syntax: **int Getch(void);**

Header: `#include "7188xa.h"`

Description: Reads a single character from the input buffer. If there is no input in the data buffer, the function will wait until the input buffer receives some data.

Return Value: 0 to 255.

---

Example: Please refer to “Kbhit()” for an example.

- **Ungetch()**

Function: Put a single character to the input buffer.

Syntax: **int Ungetch(int data);**

Header: `#include "7188xa.h"`

Description: If there is no data in the input buffer when Ungetch() is called, next time the Getch() function is called, it will return the data.

Data: 0 to 255. If the data is > 255, only the low byte will be sent.

Return: On success, returns NoError. On error (i.e. the buffer is full) returns 1.

Example: Please refer to “Kbhit()” for an example of Getch().

- **Putch()**

Function: Displays a single character on the screen.

Syntax: **void Putch(int data);**

Header: `#include "7188xa.h"`

Description: Data: 0 to 255. If the data is > 255, only the low byte will be sent.

Example: Please refer to “Kbhit()” for an example.

- **Puts()**

Function: Displays a string on the screen.

Syntax: **void Puts(char \*str);**

Header: `#include "7188xa.h"`

Description: Puts will call Putch() to send the string.  
str: The pointer to the string to be sent.

Example: Please refer to “Kbhit()” for an example.

- **Scanf()**

Function: Scans a character from the input and is similar to the scanf() function. (This function cannot be used with MSC /VC++)

Syntax: **int Scanf(char \*fmt, ...);**

Header: `#include "7188xa.h"`

Description: Returns the number of input fields successfully scanned,

---

converted, and stored. The return value does not include any scanned fields that were not stored.

Return: 0: No fields were stored.  
EOF: Attempts to read have reached the end of the string.

Example: See CD:\Napdos\7188XABC\7188XA\Demo\MSC\COM\_Ports\C\_Style\_IO\

## ● Print()

Function: Prints a formatted character to the screen, and is similar to the printf() function in the C language.

Syntax: **int Print(char \*fmt,...);**

Header: #include "7188xa.h"

Description: This function is used instead of printf(), and the only difference between Print() and printf() is that Print() does not convert the characters "\n" to "\n" + "\r". That is "\n" only sends the code 0x0A, not 0x0A + 0x0D, so "\n\r" has to be used for "new line and return". The printed message is sent to COM4. (Default parameters are 115200, N, 8, 1)

Input Parameters: Please refer to the standard function printf() in the C language.

Return: The character number to be sent out.

Example: Please refer to "Kbhit()" for an example.



## Type 2: COM port

<b>Function</b>	<b>Description</b>
InstallCom	Installs the COM Port driver. The COM Port number is not assigned
InstallCom1	Installs the driver for COM1
InstallCom2	Installs the driver for COM2 InstallCom3, InstallCom4 etc. are similar
RestallCom	Uninstalls the drivers for the COM Port. The COM Port number is not assigned
RestallCom1	Uninstalls the driver for COM1. Assigned to COM1 RestallCom2 and etc are similar
IsCom	Check if Com has data. The COM Port number is not assigned
IsCom1	Checks if any data is waiting in the COM1 buffer
IsCom2...	Checks if any data is waiting in the COM2 buffer IsCom3, IsCom4 etc. are similar
ClearCom	Clears all the data currently stored in the COM Port Buffer. The COM Port number is not assigned
ClearCom1	Clears all the data currently stored in the COM1 buffer.
ClearCom2	Clears all the data currently stored in the COM2 buffer. ClearCom3, ClearCom4 etc. are similar
ReadCom	Reads the data from COM Port buffer. The COM Port number is not assigned
ReadCom1	Reads data from the COM1 buffer
ReadCom2	Reads data from the COM2 buffer ReadCom3, ReadCom4 etc. are similar
ToCom	Sends data to the COM Port. The COM Port number is not assigned
ToCom1	Sends data to the COM1
ToCom2	Sends data to the COM2 ToCom3, ToCom4 etc. are similar
printCom	Prints any data currently stored in the COM Port buffer. The COM Port number is not assigned
printCom1	Prints any data currently stored in the COM1
printCom2	Prints any data currently stored in the COM2 printCom3, printCom4 etc. are similar
...More...	There are more functions available for use with COM

---

Ports. Please refer to the 7188xa.h file and CD:\Napdos\7188\miniOS7>manual\index.html for more detailed information.
---

**Note:** The **Print** and **printCom** function cannot be used simultaneously in the same program.

### ● **InstallCom()**

Function: Installs the driver for the COM Port.

Syntax: **int InstallCom(int port, unsigned long baud, int data, int parity, int stop);**

Header: `#include "7188xa.h"`

Description: Installs the driver for the COM Port. The COM Port number is not assigned and can be modified using the "port" parameter.

port: assigns the COM port number

baud: Baud Rate, the default Baud Rate for the I-7188XA(D) is 115200

Example:

```
#include <7188xa.h>
void main()
{
  int quit=0, data, i, port=1; /*port=1, uses COM1*/
  InitLib();
  InstallCom(port,115200,8,0,1); /*installs the COM port driver*/
  for(i=0; i<10; i++)
    printCom(port,"Test %d\n\r",i); /*prints data to the COM Port*/
  while(!quit) {
    if(IsCom(port)) { /*checks if any data is in the COM Port buffer*/
      data=ReadCom(port); /*reads data from the COM Port buffer*/
      ToCom(port,data); /*sends data to the COM Port buffer*/
      ClearCom(port); /*clears all the data in the COM Port buffer*/
      if(data=='Q') quit=1; /*if 'Q' is received, exit the program*/
    }
  }
  RestoreCom(port); /*uninstalls the driver for COM Port */
}
```

---

- **InstallCom1()**

Function: Installs the driver for COM1.

Syntax: **int InstallCom1(unsigned long baud, int data, int parity, int stop);**

Header: #include "7188xa.h"

Description: Installs the driver for COM1, and is assigned to COM1  
baud: Baud Rate, the default Baud Rate for the I-7188XA(D) is 115200

Example:

```
#include <7188xa.h>  
void main()  
{  
    int quit=0,data;  
    InitLib();  
    InstallCom1(115200,8,0,1); /*install the driver for COM1*/  
    while(!quit) {  
        if(IsCom1()) { /*checks if any data is in the COM1 buffer*/  
            data=ReadCom1(); /*reads data from COM1*/  
            ToCom1(data); /*sends data to COM1*/  
            if(data=='q') quit=1; /*if 'q' is received, exit the program*/  
        }  
    }  
    RestoreCom1(); /*uninstalls the driver for COM1*/  
}
```

- **RestoreCom()**

Function: Uninstalls the driver for the COM Port. The COM Port number is not assigned.

Syntax: **int RestoreCom(int port);**

Header: #include "7188xa.h"

Description: Uninstalls the driver for the COM Port. The COM Port number is not assigned and can be modified using the "port" parameter.

port: assigns the COM Port number

Example: Please refer to "InstallCom()" for an example.

- **RestoreCom1()**

Function: Uninstall the driver for COM1.

Syntax: **int RestoreCom1(void);**

---

Header: #include "7188xa.h"

Description: Uninstall the driver for COM1 and is assigned to COM1

Example: Please refer to "InstallCom1()" for an example.

- **IsCom()**

Function: Checks whether there is any data stored in the COM Port buffer. The COM Port number is not assigned.

Syntax: **int IsCom(int port);**

Header: #include "7188xa.h"

Description: Checks whether there is any data stored in the COM Port buffer. The COM Port number is not assigned and can be modified using the "port" parameter.

port: assigns the COM port number

Example: Please refer to "InstallCom()" for an example.

- **IsCom1()**

Function: Checks whether there is any data stored in the buffer of COM1.

Syntax **int IsCom1(void);**

Header: #include "7188xa.h"

Description: Checks whether there is any data stored in the buffer of COM1

Example: Please refer to "InstallCom1()" for an example.

- **ReadCom()**

Function: Reads data from the COM Port buffer. The COM Port number is not assigned.

Syntax: **int ReadCom(int port);**

Header: #include "7188xa.h"

Description: Reads data from the COM Port buffer. The COM Port number is not assigned and can be modified using the "port" parameter.

port: assigns the COM Port number

Example: Please refer to "InstallCom()" for an example.

- **ReadCom1()**

Function: Reads data from the buffer of COM1.

Syntax: **int ReadCom1(void);**

---

Header: #include "7188xa.h"

Description: Reads data from the buffer of COM1. Assigned to COM1.

Example: Please refer to "InstallCom1()" for an example.

- **ClearCom()**

Function: Clears the data currently stored in the COM Port buffer. The COM Port number is not assigned.

Syntax: **int ClearCom(int port);**

Header: #include "7188xa.h"

Description: Clears the data currently stores in the COM Port buffer. The COM Port number is not assigned and can be modified using the "port" parameter.

port: assigns the COM Port number

Example: Please refer to "InstallCom()" for an example.

- **ClearCom1()**

Function: Clears the data currently stored in the buffer of COM1.

Syntax: **int ClearCom1(void);**

Header: #include "7188xa.h"

Description: Clears the data currently stored in buffer of COM1. Assigned to COM1.

Example: Please refer to "InstallCom1()" for an example.

- **ToCom()**

Function: Sends data to the COM Port. The COM Port number is not assigned.

Syntax: **int ToCom(int port);**

Header: #include "7188xa.h"

Description: Sends data to the COM Port. The COM Port number is not assigned and can be modified using the "port" parameter.

port: assigns the COM Port number

Example: Please refer to "InstallCom()" for an example.

- **ToCom1()**

Function: Sends data to COM1.

Syntax: **int ToCom1(void);**

---

Header: `#include "7188xa.h"`

Description: Sends data to COM1. Assigned to COM1.

Example: Please refer to "InstallCom1()" for an example.

- **printCom()**

Function: Prints data to COM and PC. The COM Port number is not assigned.

Syntax: `int printCom(int port,char *fmt,...);`

Header: `#include "7188xa.h"`

Description: Prints data from the COM Port buffer. The COM Port number is not assigned and can be modified using the "port" parameter. Produces a formatted output, similar to printf() from the standard C library.

Example: Please refer to "InstallCom()" for an example.

- **printCom1()**

Function: Prints data from the buffer of COM1.

Syntax: `int printCom_1(char *fmt,...);`

Header: `#include "7188xa.h"`

Description: Prints data from the buffer of COM1. Produces a formatted output, similar to printf() from standard C library.

Example: This function is similar to printCom(). Please refer to "InstallCom()" for an example.

---

## Type 3: EEPROM

Function	Description
EE_WriteEnable	Sets the EEPROM to write-enable mode
EE_MultiWrite	Writes data to the EEPROM
EE_WriteProtect	Sets the EEPROM to write-protect mode
EE_MultiRead	Reads data from the EEPROM
...More...	There are many other user functions related to EEPROM. Please refer to the 7188xa.h header file and the user manual on the enclosed CD, which can be found at CD:\Napdos\MiniOS7\document\Lib_Manual_For_7188XABC\index.htm for more detailed information.

### ● EE\_WriteEnable ()

Function: Sets the EEPROM to write-enable mode.

Syntax: **void EE\_WriteEnable (void);**

Header: #include "7188xa.h"

Description: Sets the EEPROM to write-enable mode. The EEPROM is in write-protect mode by default. EE\_WriteEnable() must be called before writing data to the EEPROM.

Example:

```
#include <7188xa.h>
void main()
{
    Int data=55, data2;
    InitLib();
    EE_WriteEnable ();
    EE_MultiWrite(1,10,1,&data);
    EE_WriteProtect();
    EE_MultiRead(1,10,1,&data2);
    Print("data=%d, Data2=%d", data,data2);
}
```

### ● EE\_MultiWrite ()

Function: Writes data to the EEPROM

Syntax: **int EE\_MultiWrite(int Block,unsigned Addr,int no,char \*Data);**

Header: #include "7188xa.h"

Description: Writes multi-byte of data to the EEPROM.

---

Block: 0 to 7 (a total of 8 blocks).

Addr: 0 to 255 (each block can contain 256 bytes).

no: 1 to 16

Data: The start address of buffer that the data is stored.

Return Value: On success, returns NoError.

On error, returns -1. It is say EEPROM is busy, Block is invalid or Addr is invalid.

Example: Please refer to “EE\_WriteEnable()” for an example.

### ● **EE\_WriteProtect ()**

Function: Sets the EEPROM to write-protect mode

Syntax: **void EE\_WriteProtect(void);**

Header: #include "7188xa.h"

Description: Sets the EEPROM to write-protect mode. The EEPROM is in write-protect mode by default. EE\_WriteEnable() must be called before writing data to the EEPROM. After writing the data, it is recommended that EE\_WriteProtect () be called to return the EEPROM to write-protect mode.

Example: Please refer to “EE\_WriteEnable()” for an example.

### ● **EE\_MultiRead ()**

Function: Reads data from the EEPROM

Syntax: **int EE\_MultiRead(int StartBlock,unsigned StartAddr,int no,char \*databuf);**

Header: #include "7188xa.h"

Description: Reads multi-byte data from the EEPROM.

StartBlock: 0 to 7 (a total of 8 blocks).

StartAddr: 0 to 255 (each block can contain 256 bytes).

no: 1 to 2048

databuf: The address to store data

Return Value: On success, returns NoError.

On error, returns -1. It is say EEPROM is busy, Block is invalid or Addr is invalid.

Example: Please refer to “EE\_WriteEnable()” for an example.



## Type 4: NVRAM and RTC

Function	Description
ReadNVRAM	Reads data from the NVRAM.
WriteNVRAM	Writes data to the NVRAM.
GetTime	Gets the system time from the RTC.
SetTime	Sets the system time for the RTC
GetDate	Gets the system date from the RTC
SetDate	Sets the system date for the RTC
GetWeekDay	Gets the day of the week from the RTC.
...More...	There are many other functions related to the NVRAM and the RTC. Please refer to the 7188xa.h header file and the user manual on the enclosed CD, which can be found at CD:\Napdos\minios7\document\lib_manual_for_7188xabc\index.htm for more detailed information.

### ● ReadNVRAM()

Function: Reads data from the NVRAM.

Syntax: **int ReadNVRAM(int addr);**

Header: `#include "7188xa.h"`

Description: Reads one byte of data from the NVRAM.  
addr: 0 to 30, a total of 31 bytes.

Return Value: On success, returns the data (0-255) stored at the specified address.

On error, returns the AddrError (-9).

Example:

```
#include <7188xa.h>  
void main()  
{  
    int data=55, data2;  
    InitLib();  
    WriteNVRAM(0,data);  
    data2=ReadNVRAM(0); /* now data2=data=55 */  
    Print("data=%d, data2=%d",data,data2);  
}
```

### ● WriteNVRAM()

Function: Writes data to the NVRAM.

Syntax: **int WriteNVRAM(int addr, int data);**

---

Header: #include "7188xa.h"

Description: Writes one byte of data to the NVRAM.

addr: 0-30.

data: One byte of data (0-255).

If the data>255, only the low byte will be written to the NVRAM.

Return Value: On success, returns NoError.

On error, returns the AddrError (-9).

Example: Please refer to "ReadNVRAM()" for more detailed information.

### ● GetTime()

Function: Retrieves the system time from the RTC.

Syntax: **void GetTime(int \*hour, int \*minute, int \*sec);**

Header: #include "7188xa.h"

Description: hour: The address used to save the hour (0-23) data.

minute: The address used to save the minute (0-59) data.

sec: The address used to save the second (0-59) data.

Example:

```
#include <7188xa.h>
```

```
void main()
```

```
{
```

```
    int year, month, day, hour, min, sec, wday;
```

```
    InitLib();
```

```
    SetDate(2006,1,12); /*sets the system date for the RTC*/
```

```
    SetTime(15,35,50); /*sets the system time for the RTC*/
```

```
    SetWeekDay(4); /*sets the system day of the week for the RTC*/
```

```
    GetDate(&year,&month,&day); /*reads the system date from the RTC*/
```

```
    GetTime(&hour,&min,&sec); /*reads the system time from the RTC*/
```

```
    wday=GetWeekDay();
```

```
    Print("Date=%02d/%02d/%04d(%d) Time=%02d:%02d:%02d\n\r",  
        month,day,year,wday,hour,min,sec);
```

```
}
```

### ● SetTime()

Function: Sets the system time to the RTC

Syntax: **int SetTime(int hour,int minute,int sec);**

Header: #include "7188xa.h"

---

Description: hour: 0-23.  
minute: 0-59.  
sec: 0-59.

Return Value: On success, returns NoError.  
On error, returns the TimeError (-19).

Example: Please refer to "GetTime()" for more detailed information.

- **GetDate()**

Function: Reads the system date from the RTC

Syntax: **void GetDate(int \*year,int \*month,int \*day);**

Header: #include "7188xa.h"

Description: year: 2000-2080  
month: 1-12  
day: 1-31

Example: Please refer to "GetTime()" for more detailed information.

- **SetDate()**

Function: Sets the system date to the RTC

Syntax: **int SetDate(int year,int month,int day);**

Header: #include "7188xa.h"

Description: year: 2000-2080  
month: 1-12  
day: 1-31

Return Value: On success, returns NoError.  
On error, returns DateError (-18).

Example: Please refer to "GetTime()" for more detailed information.

- **GetWeekDay()**

Function: Reads the weekday from the RTC.

Syntax: **int GetWeekDay(void);**

Header: #include "7188xa.h"

Description: Reads the weekday from the RTC.

Return Value: 0=>Sunday  
1-6=>Monday to Saturday.

Example: Please refer to "GetTime()" for more detailed information.

**Note:** GetWeekDay() does not check whether the weekday is correct or not, only reads the value from the RTC. When using the MiniOS7

---

“date” command to set the date, the MiniOS7 will calculate the correct weekday and set the RTC. If SetDate() is called, it will also calculate the correct weekday and set the RTC. However, if SetWeekDay() is called, the function must calculate the correct weekday itself.

---

## Type 5: Flash Memory

Function	Description
FlashReadId	Retrieves the information about Flash.
FlashErase	Erases a single sector of the Flash memory.
FlashWrite	Writes one byte of data to the Flash memory.
FlashRead	Reads one byte of data from the Flash memory.
...More...	There are many other functions related to the Flash memory. Please refer to the 7188xa.h header file and the user manual on the enclosed CD, which can be found at CD:\Napdos\minios7\document\lib_manual_for_7188xabc\index.htm for more detailed information.

The Flash memory used in I-7188XA(D) series modules has a capacity of 512K bytes. The MiniOS7 will use the last 64K bytes, and the remaining space can be used to store custom programs or data.

Application developers can use these functions to write data to the Flash memory. When writing data to the Flash memory, data only be written from “1” to “0”, and cannot be written from “0” to “1”. So, before writing data to the Flash memory, must be erased first. The erase process will cause all data to revert to 0xFF, that is all data bits will be “1”. Only then can data be written. The FlashErase() function is used to erase one sector (64K bytes) each time.

### ● FlashReadId()

Function: Retrieves the information about Flash.

Syntax: **int FlashReadId(void);**

Header: #include "7188xa.h"

Description: Reads the Flash memory device code (high byte) and manufacturer code (low byte).

Return Value: 0xA4C2 (MXIC 29f040), 0xA401 (AMD 29f040)

Example: See CD:\Napdos\7188XABC\7188XA\Demo\BC\_TC\  
Memory\

### ● FlashErase()

Function: Erases a single sector of the Flash memory.

Syntax: **int FlashErase(unsigned seg);**

---

Header: #include "7188xa.h"

Description: Erases a single sector (64K bytes) of the Flash memory.  
The value of all data on that sector will revert to 0xFF.  
seg: 0x8000, 0x9000, 0xA000, 0xB000, 0xC000,  
0xD000 or 0xE000.

Return Value: On success, returns NoError (0).  
On error, returns TimeOut (-5).

Example: Please refer to "\Demo\BC\_TC\Memory\Flash\FLASH.C"  
for more detailed information.

**Note:** Segment 0xF000 is used to store the MiniOS7, if attempting to  
erase segment 0xF000, FlashErase() will do nothing.

### ● FlashWrite()

Function: Writes one byte of data to Flash memory.

Syntax: **int FlashWrite(unsigned int seg, unsigned int offset,  
char data);**

Header: #include "7188xa.h"

Description: seg: 0x8000, 0x9000, 0xA000, 0xB000, 0xC000,  
0xD000 or 0xE000.  
offset: 0 to 65535 (0xffff).  
data: 0 to 255 (8-bit data).

Return Value: On success, returns NoError(0).  
On error, returns TimeOut(-5) or SegmentError(-12).

Example:

```
#include <7188xa.h>  
void main()  
{  
    int data=0xAA55, data2;  
    char *dataptr;  
    InitLib();  
    dataptr=(char *)&data;  
    FlashWrite(0xd000,0x1234, *dataptr++);    /*writes data to the Flash  
                                                memory*/  
  
    FlashWrite(0xd000,0x1235, *dataptr);  
    dataptr=(char *)&data2;    /*reads data from the Flash memory*/  
    *dataptr=FlashRead(0xd000, 0x1234);  
    *(dataptr+1)=FlashRead(0xd000, 0x1235);  
}
```

---

**Note:** When writing data to the Flash memory, the data bit only can be changed from 1 to 0 and cannot be written from “0” to “1”. FlashWrite() does not check the status, and just writes the data. If an attempt is made to change the data from 0 to 1, a TimeoutError will occur. After calling FlashErase() data can be written again.

● **FlashRead()**

Function: Reads one byte of data from the Flash memory.

Syntax: **int FlashRead(unsigned int seg, unsigned int offset);**

Header: #include "7188xa.h"

Description: seg: 0-65535(0xffff).

offset: 0 to 65535(0xffff).

Return Value: FlashRead() only returns the value of the address.

seg:offset. The address can be from the SRAM, the Flash memory or another address (generally returns 0xff).

Example: Please refer to “FlashWrite()” function for more detailed information.

## Type 6: Timer and Watchdog Timer

<b>Function</b>	<b>Description</b>
TimerOpen	Opens the timer function for use.
TimerClose	Stops the timer function.
TimerResetValue	Resets the timer to 0.
TimerReadValue	Reads the main time ticks.
DelayMs	Inserts a delay for a specific time interval. The time unit is ms, and uses system time ticks.
Delay	Inserts a delay for a specific time interval. The time unit is ms, and uses the Timer 1 feature of the CPU.
Delay_1	Inserts a delay for a specific time interval. The time unit is 0.1 ms, and uses the Timer 1 feature of the CPU.
Delay_2	Inserts a delay for a specific time interval. The time unit is 0.01 ms, and uses the Timer 1 feature of the CPU.
StopWatchStart	Starts using a StopWatch channel.
StopWatchReset	Resets the StopWatch value to 0.
StopWatchStop	Disables the StopWatch channel.
StopWatchPause	Pauses the StopWatch.
StopWatchContinue	Restarts the StopWatch.
StopWatchReadValue	Reads the current StopWatch value.
CountDownTimerStart	Starts using CountDownTimer.
CountDownTimerReadValue	Reads the current CountDownTimer value
InstallUserTimer	Installs a user timer function, which will be called at intervals of 1 ms.
InstallUserTimer1C	Installs a user timer function on interrupt 0x1c. System timer will call int 0x1c at intervals of 55 ms.
EnableWDT	Enables the Watchdog timer
DisableWDT	Disables the Watchdog timer
RefreshWDT	Refreshes the Watchdog timer
...More...	There are many other custom timer and Watchdog Timer functions available. Please refer to the 7188xa.h header file



---

	and the user manual on the enclosed CD, which can be found at CD:\Napdos\minios7\document\lib_manual_for_7188xabc\index.htm for more detailed information.
--	---

## ● TimerOpen()

Function: Opens the timer function for use.

Syntax: **int TimerOpen(void);**

Header: `#include "7188xa.h"`

Description: Before any of the timer functions can be used the TimerOpen() function must be called.

Return Value: On success, returns NoError. If the Timer is already open, returns 1.

Example:

```
#include <7188xa.h>  
void main()  
{  
    unsigned long time;  
    int quit=0;  
    InitLib();  
    Print("\n\nPress any key to start the timer");  
    Print("\n\nthen Press '0' to Reset the timer, '1'~'4' to insert a delay, 'q' to quit\n\n");  
    Getch();  
    TimerOpen(); /*open the timer function*/  
    while(!quit){ /*sets the key function*/  
        if(Kbhit()){  
            switch(Getch()){  
                case '0':  
                    TimerResetValue(); /*reset the timer*/  
                    break;  
                case '1':  
                    DelayMs(1000); /*delay unit is ms, uses system timeticks. */  
                    break;  
                case '2':  
                    Delay(1000); /*delay unit is ms, uses the Timer 1 feature of the CPU. */  
                    break;  
                case '3':  
                    Delay_1(1000); /*delay unit is 0.1 ms, uses the Timer 1 feature
```

```

                                of the CPU.*/
        break;
    case '4':
        Delay_2(1000); /*delay unit is 0.01 ms, uses the Timer 1
                        feature of the CPU .*/

        break;
    case 'q':
        quit=1;
        break;
    }
}
time=TimerReadValue(); /*reads the timer*/
Print("\r\nTime=%8.3f sec", 0.001*time);
}
TimerClose(); /*closes the timer function*/
}

```

### ● TimerClose()

Function: Stops the timer function.

Syntax: **int TimerClose(void);**

Header: #include "7188xa.h"

Description: If the program has called the OpenTimer() function, it must call TimerClose() before exiting.

Return Value: Always returns NoError.

Example: Please refer to "TimerOpen()" function for more detailed information.

### ● TimerResetValue()

Function: Resets the timer to 0.

Syntax: **void TimerResetValue(void);**

Header: #include "7188xa.h"

Description: Resets the main time ticks to 0.

Example: Please refer to "TimerOpen()" function for more detailed information.

### ● TimerReadValue()

Function: Reads the main time ticks.

Syntax: **unsigned long TimerReadValue(void);**

Header: #include "7188xa.h"

Description: Reads the main time ticks. The time unit is ms. When

---

TimerOpen or TimerReset are called, the time ticks will be reverted to 0.

Example: Please refer to “TimerOpen()” function for more detailed information.

- **DelayMs()**

Function: Inserts a delay for a specific time interval. The time unit is ms and uses system time ticks.

Syntax: **void DelayMs(unsigned t);**

Header: #include "7188xa.h"

Description: Delay time unit is ms.  
t: the delay time.

Example: Please refer to “TimerOpen()” function for more detailed information.

- **Delay()**

Function: Inserts a delay for a specific time interval. The time unit is ms and uses Timer 1 feature of the CPU.

Syntax: **void Delay(unsigned ms);**

Header: #include "7188xa.h"

Description: Inserts a delay for a specific time interval. The time unit is ms and uses the Timer 1 feature of the CPU.  
ms: the delay time.

Example: Please refer to “TimerOpen()” function for more detailed information.

- **Delay\_1()**

Function: Inserts a delay for a specific time interval. The time unit is 0.1 ms and uses the Timer 1 feature of the CPU.

Syntax: **void Delay\_1(unsigned ms);**

Header: #include "7188xa.h"

Description: Inserts a delay for a specific time interval. The time unit is 0.01 ms and uses the Timer 1 feature of the CPU.  
ms: the delay time.

Example: Please refer to “TimerOpen()” function for more detailed information.

- **Delay\_2()**

---

Function: Inserts a delay for a specific time interval. The time unit is 0.01 ms and uses the Timer 1 of the CPU.

Syntax: **void Delay\_2(unsigned ms);**

Header: #include "7188xa.h"

Description: Inserts a delay for a specific time interval. The time unit is 0.01 ms and uses the Timer 1 feature of the CPU.  
ms: the delay time.

Example: Please refer to "TimerOpen()" function for more detailed information.

### ● **StopWatchStart()**

Function: Starts using a StopWatch channel, and resets the StopWatch value to 0.

Syntax: **int StopWatchStart(int channel);**

Header: #include "7188xa.h"

Description: The system timer ISR will increment the StopWatch value by 1 in 1 ms intervals.  
channel: 0-7, a total of 8 channels.

Return Value: On success, returns NoError.

If the channel is out of range, returns ChannelError (-15).

Example:

```
#include <7188xa.h>  
void main(void)  
{  
    unsigned long value;  
    int quit=0; InitLib();  
    Print("\n\rTest the StopWatch ... Press 'q' to quit\n\r ");  
    TimerOpen();  
    StopWatchStart(0); /*start using the StopWatchStart function*/  
    while(!quit){  
        if(Kbhit()){ switch(Getch()){ case 'q': quit=1; break; } }  
        StopWatchReadValue(0,&value);  
        Print("SWatch=%d \r",value);  
        if(value==2000){  
            StopWatchPause(0);  
            DelayMs(2000);  
            StopWatchContinue(0); }  
        if(value==4000){  
            StopWatchStop(0);  
    }
```

```

        DelayMs(2000);
        StopwatchReset(0);
        StopwatchStart(0);
    }
}
TimerClose();
}

```

- **StopWatchReset()**

Function: Resets the StopWatch value to 0.

Syntax: **int StopWatchReset(int channel);**

Header: #include "7188xa.h"

Description: channel: 0-7, a total of 8 channels.

Return Value: On success, returns NoError.

If the channel is out of range, returns ChannelError (-15).

Example: Please refer to "StopWatchStart()" function for more detailed information.

- **StopWatchStop()**

Function: Disables the StopWatch channel.

Syntax: **int StopWatchStop(int channel);**

Header: #include "7188xa.h"

Description: The system timer ISR will stop to increment the StopWatch value.

channel: 0-7, a total of 8 channels.

Return Value: On success, returns NoError.

If the channel is out of range, returns ChannelError (-15).

Example: Please refer to "StopWatchStart ()" function for more detailed information.

- **StopWatchPause()**

Function: Pauses the StopWatch.

Syntax: **int StopWatchPause(int channel);**

Header: #include "7188xa.h"

Description: After calling StopWatchPause(), StopWatchContinue() must be called to restart the time counter.

---

channel:0-7, a total of 8 channels.

Return Value: On success, returns NoError.

If the channel is out of range, returns ChannelError (-15).

Example: Please refer to “StopWatchStart ()” function for more detailed information.

- **StopWatchContinue()**

Function: Restarts the StopWatch.

Syntax: **int StopWatchContinue(int channel);**

Header: #include "7188xa.h"

Description: channel:0-7, a total of 8 channels.

Return Value: On success, returns NoError.

If the channel is out of range, returns ChannelError (-15).

Example: Please refer to “StopWatchStart ()” for more detailed information.

- **StopWatchReadValue()**

Function: Reads the current StopWatch value.

Syntax: **int StopWatchReadValue(int channel,unsigned long \*value);**

Header: #include "7188xa.h"

Description: The value represents the time that has elapsed since either a StopWatchStart() or StopWatchReset() was last called.

channel: 0-7, a total of 8 channels.

Return Value: On success, returns NoError().

If the channel is out of range, returns ChannelError (-15).

Example: Please refer to “StopWatchStart ()” for detailed more information.

- **CountDownTimerStart()**

Function: Starts using the CountDownTimer.

Syntax: **int CountDownTimerStart(int channel,unsigned long count);**

Header: #include "7188xa.h"

---

Description: channel: 0-7, a total of 8 channels.

count: the amount of time to be counted.

Return Value: On success, returns NoError().

If the channel is out of range, returns ChannelError (-15).

Example:

```
#include <7188xa.h>
void main(void)
{
    unsigned long value;
    int quit=0;
    InitLib();
    Print("\n\nTest the CountdownTimer...");
    Print("\n\nPress 'q' to quit\n\n");
    TimerOpen();
    CountDownTimerStart(0,1000); /*use the CountdownTimer*/
    while(!quit){
        if(Kbhit()&&(Getch()=='q')) quit=1;
        CountDownTimerReadValue(0,&value); /*reads the
            CountDownTimer*/
        Print("Test Countdown=%d\n",value);
        if(value==0)
            CountDownTimerStart(0,1000); /*restarts the CountdownTimer*/
    }
    TimerClose();
}
```

### ● CountdownTimerReadValue()

Function: Reads the current value of the CountdownTimer(count).

Syntax: **int CountdownTimerReadValue(int channel,unsigned long \*value);**

Header: **#include "7188xa.h"**

Description: If the return value is 0, it means that the time has expired.

channel: 0-7, a total of 8 channels.

value: a pointer to the location where the value is to be stored.

Return Value: On success, returns NoError().

If the channel is out of range, returns ChannelError

---

(-15).

Example: Please refer to “CountDownTimerStart ()” function for more detailed information.

### ● InstallUserTimer()

Function: Installs a custom timer function, which will be called at intervals of 1ms.

Syntax: **void InstallUserTimer(void (\*fun)(void));**

Header: #include "7188xa.h"

Description: fun: A pointer to the custom function. The function cannot use an input argument and cannot return a value.

Example:

```
#include <7188xa.h>
int Data[3]={0,0,0};
void MyTimerFun(void) /*custom timer function*/
{
    static int count[3]={0,0,0};
    int i;
    for(i=0;i<3;i++){
        Print("count[%d]=%d\r",i,count[i]);
        count[i]++;
    }
    if(count[0]>=200){ /*LCD lamp1 blinks each 200 units*/
        count[0]=0;
        if (Data[0]==0) Data[0]=1;
        else Data[0]=0;
        lamp(1,1,Data[0]);
    }
    if(count[1]>=500){ /*LCD lamp2 blinks each 500 units*/
        count[1]=0;
        if (Data[1]==0) Data[1]=1;
        else Data[1]=0;
        lamp(2,1,Data[1]);
    }
    if(count[2]>=1000){ /*LCD lamp3 blinks each 1000 units*/
        count[2]=0;
        if (Data[2]==0) Data[2]=1;
        else Data[2]=0;
        lamp(3,1,Data[2]);
    }
}
```



---

```

void main(void)
{
    int quit=0;
    Print("\n\rTest the LCD lamp blink using user timer ");
    Print("\n\rPress 'q' to quit\n\r");
    InitLib(); InitLCD(); /*initial Lib & LCD*/
    ClrScrn(); /*clear the LCD screen*/
    TimerOpen(); /*open timer function*/
    InstallUserTimer(MyTimerFun); /*install and call user timer */
    while(!quit){
        if(Kbhit() && Getch()=='q') quit=1;
    }
    TimerClose();
}

```

- **InstallUserTimer1C()**

Function: Installs a custom timer function on interrupt 0x1c. The system timer will call int 0x1c at intervals of 55 ms.

Syntax: **void InstallUserTimer1C(void (\*fun)(void));**

Header: #include "7188xa.h"

Description: fun: A pointer to the custom function. The function cannot use an input argument and cannot return a value.

Example: Please refer to "InstallUserTimer()" function for a similar example.

- **EnableWDT()**

Function: Enables the WatchDog timer.

Syntax: **void EnableWDT(void);**

Header: #include "7188xa.h"

Description: The WatchDog Timer (WDT) is always enabled and will be continually refreshed by the system Timer ISR. When a custom program calls EnableWDT(), the system timer ISR will stop refreshing the WDT, which must then be performed by calling RefreshWDT() from within the program, otherwise, the system will be reset by the WDT. The WDT timeout period is 0.8 seconds for MiniOS7 2.0.

Example:

```

#include"7188xa.h"
void main(void)
{

```

```

int quit=0,k;
InitLib();
if(IsResetByWatchDogTimer()) /*test whether the system has been
                               reset by the WDT*/
    Print("reset by WatchDog timer\n\n");
EnableWDT(); /*after calling EnableWDT, Refresh WDT must be called
              within 0.8s*/
while(!quit){
    if(Kbhit() {
        k=Getch();
        if(k=='q') {
            Print("quit the program\n\n");
            quit=1; /*quit the program*/
        }
        else {
            Print("more than 0.8s has elapsed reset the system\n\n");
            Delay(1000); /*There has been a delay for more than 0.8s. Reset
                          the system*/
        }
    }
    RefreshWDT(); /*Refresh WDT must be called within 0.8s*/
    Print("call Refresh WDT\n\n");
}
DisableWDT(); /*Disable the WDT. The system will refresh the WDT*/
Print("Call DisableWDT\n\n");
}

```

### ● DisableWDT()

Function: Disables the WatchDog timer.

Syntax: **void DisableWDT(void);**

Header: #include "7188xa.h"

Description: See the description for EnableSDT().

Example: Please refer to "EnableWDT()" function for more detailed information.

### ● RefreshWDT()

Function: Refreshes the WatchDog timer.

Syntax: **void RefreshWDT(void);**

Header: #include "7188xa.h"

Description: See the description for EnableSDT().

Example: Please refer to "EnableWDT()" function for more detailed

---

information.

- **IsResetByWatchDogTime()**

Function: Checks if system has been reset by the WatchDog Timer.

Syntax: **int IsResetByWatchDogTime(void);**

Header: #include "7188xa.h"

Description: Returns 0 when true.

Example: Please refer to "EnableWDT()" function for more detailed information.

## Type 7: Files

Function	Description
GetFileNo	Retrieves total number of files stored in the Flash memory.
GetFileName	Uses the file index to retrieve the file name.
GetFilePositionByNo	Uses the file number to retrieve the file position.
GetFileInfoByNo	Uses the file number to retrieve the file information.
GetFileInfoByName	Uses the file name to retrieve the file information.
...More...	There are many other custom file functions available. Please refer to the 7188xa.h header file and the user manual on the enclosed CD, which can be found at CD:\Napdos\minios7\document\lib_manual_for_7188xabc\index.htm for more detailed for more detailed information.

**Note:** The file system for MiniOS7 supports custom programs for reading files, but does not support custom programs for writing files.

### ● **GetFileNo()**

Function: Gets the total number of files stored in the Flash memory.

Syntax: **int GetFileNo(void);**

Header: #include "7188xa.h"

Description: Returns the number of files.

Example: Please refer to "GetFilePositionByNo()" for more detailed information.

### ● **GetFileName()**

Function: Uses the file index to get the file name.

Syntax: **int GetFileName(int no,char \*fname);**

Header: #include "7188xa.h"

Description: no: The file index (The first file is index 0).

fname: Buffer to store file name.

Return Value: On success, returns NoError, and stores the filename to the fname.

On error, returns -1, and does not save any data to the fname.

---

Example: Please refer to “GetFilePositionByNo()” for more detailed information.

### ● GetFilePositionByNo()

Function: Uses the file number to read the file position.

Syntax: **char far \*GetFilePositionByNo(int no);**

Header: #include "7188xa.h"

Description: The address can be used to get the file data.

no: The file index (The first file is index 0).

Return Value: On success, returns the starting address of the file.

On error, returns NULL.

**Note:** If the file size is > 64K-16, a huge pointer (char huge \*) data type must be used to retrieve the file data for the offset.

Example:

```
#include "7188xa.h"
```

```
static FILE_DATA far *fdata; /*file_data structure, please see the file.c  
                             for details*/
```

```
char far *fp_no;
```

```
void main()
```

```
{
```

```
    int fileno,i;
```

```
    char fname[13];
```

```
    InitLib(); /*Initialize the Library*/
```

```
    fileno=GetFileNo(); /*get file number*/
```

```
    Print("Total file number=%d\n\r",fileno);
```

```
    fname[12]=0;
```

```
    for(i=0;i<fileno;i++){
```

```
        fdata=GetFileInfoByNo(i); /*get file information using the file  
                                   number*/
```

```
        if(fdata) {
```

```
            GetFileName(i,fname); /*get file name*/
```

```
            Print("[%02d]:%-12s start at %Fp "
```

```
                "%02d/%02d/%04d %02d:%02d:%02d size=%lu\n\r", i,fname,
```

```
                fdata->addr,fdata->month,fdata->day,(fdata->year)+1980,
```

```
                fdata->hour,fdata->minute,fdata->sec*2,fdata->size);
```

```
        }
```

```
    }
```

```
    for(i=0;i<fileno;i++){
```

```
        fp_no=(char far *)GetFilePositionByNo(i); /*get file position*/
```

---

```
    if(fp_no){
        GetFileName(i,fname);
        Print("file %d [%-12s] position: [ %Fp ]\r\n",i,fname,fp_no);
    }
}
}
```

- **GetFileInfoByNo()**

Function: Uses the file number index to retrieve file information.

Syntax: **FILE\_DATA far \*GetFileInfoByNo(int no);**

Header: #include "7188xa.h"

Description: no: The file index (The first file is index 0).

Return Value: On success, returns the starting address of the file information.

On error, returns NULL.

Example: Please refer to "GetFilePositionByNo()" for more detailed information.

- **GetFileInfoByName()**

Function: Uses the file name to retrieve the file information.

Syntax: **char far \*GetFileInfoByName(char \*fname);**

Header: #include "7188xa.h"

Description: fname: The file name.

Return Value: On success, returns the starting address of the file information.

On error, returns NULL.

Example: Please refer to "GetFilePositionByNo()" for more detailed information.

## Type 8: Connecting to I-7000/I-87K series module

Function	Description
SendCmdTo7000	Sends a command to an I-7000/I-87K series module.
ReceiveResponseFrom7000_ms	Receives a response from an I-7000/I-87K series module
ascii_to_hex	Converts the ASCII code to a hexadecimal value.
hex_to_ascii	Converts a hexadecimal value to ASCII code.
...More...	There are many other functions related to connecting to I-7000/I-87K series module. Please refer to the 7188xa.h header file and the user manual on the enclosed CD, which can be found at CD:\Napdos\minios7\document\lib_manual_for_7188xabc\index.htm for more detailed information.

### ● SendCmdTo7000()

Function: Sends a command to an I-7000 series module.

Syntax: **int SendCmdTo7000(int iPort, unsigned char \*cCmd, int iChecksum);**

Header: `#include "7188xa.h"`

Description: If the checksum is enabled, the function will add 2 bytes checksum to the end of the command.

iPort: 0/1/2/3/4 for COM0/1/2/3/4.

cCmd: The command to be sent (DO NOT add "\r" at the end of the cCmd as SendCmdTo7000() will add a checksum (if needed) and "\r" after the cCmd).

iChecksum: 1 for checksum enabled, 0 for checksum disabled.

Return Value: On success, returns NoError.

On error, returns an Error code. Refer to the user manuals for I-7000 series modules for more details.

Example:

```
#include <7188xa.h>  
void main()  
{  
    int port=2,quit=0,x;
```

---

```

char k;
InitLib();
InstallCom(port,115200L,8,0,1); /*install a COM Port for the I-7065D*/
ClearCom(port);
SendCmdTo7000(port, "@0100", 0); /*send a command to DO to off*/
if(ReceiveResponseFrom7000_ms(port,"@0100",20,0))
    Print("I-7065D is not available\n\n");
while(!quit){ /*control Do*/
    Print("\n\n Enter 1~5 to set [Do] on...'9' to quit\n\n");
    k=Getch();
    x=ascii_to_hex(k); /*convert ASCII code to hex*/
    ClearCom(port);
    switch(x){ /*send a command to set the I-7065D Do1~5 light to on*/
        case 1: /*for command details, refer to the "I-7000 DIO manual"*/
            SendCmdTo7000(port, "@0101", 0);Print("[%x]=ON",x);break;
        case 2:
            SendCmdTo7000(port, "@0102", 0); Print("[%x]=ON",x);break;
        case 3:
            SendCmdTo7000(port, "@0104", 0); Print("[%x]=ON",x);break;
        case 4:
            SendCmdTo7000(port, "@0108", 0); Print("[%x]=ON",x);break;
        case 5:
            SendCmdTo7000(port, "@0110", 0); Print("[%x]=ON",x);break;
        case 9:
            quit=1; Print("**quit**");break;
    } /*end of switch*/
} /*end of while loop*/
}

```

- **ReceiveResponseFrom7000\_ms()**

Function: Receives a response from the I-7000 module.

Syntax: **int ReceiveResponseFrom7000\_ms(int iPort, unsigned char \*cCmd, long ITimeout, int iChksum);**

Header: #include "7188xa.h"

Description: After calling the SendCmdTo7000() function, the ReceiveResponseFrom7000\_ms() function must be called except for commands that do not require a response.

iPort: 1 for COM1, 2 for COM2, etc.

cCmd: The response received from the I-7000 module. If checksum is enabled, the function will check and



---

remove the checksum. The CR is also removed.  
ITimeout: Sets the timeout. The unit is ms.  
iChecksum: 1 for checksum enabled, 0 for checksum disabled.

Return Value: On success, returns NoError.

On error, returns an Error code. Refer to the use manuals for I-7000 series modules for more details.

Example: Please refer to SendCmdTo7000() for more detailed information.

● **ascii\_to\_hex()**

Function: Converts ASCII code to a hexadecimal value.

Syntax: **int ascii\_to\_hex(char ascii);**

Header: #include "7188xa.h"

Description: Returns an integer representing the Hex value.

ascii: The ASCII code char

Example: Please refer to SendCmdTo7000() for more detailed information.

---

# Appendix E: Compiling and linking

## Using the TC Compiler

There are two procedures for using the TC compiler, TC 2.01, which are described as follows:

**Method 1:** Using a command line (For more information, please refer to `CD:\8000\NAPDOS\7188XABC\7188XA\Demo\BC_TC\Hello_C\gotc.bat`)

`tcc -Ic:\tc\include -Lc:\tc\lib hello1.c ../lib\7188xas.lib`

**Method 2:** Using the TC Integrated Environment

Step 1: Execute TC.EXE to run the TC 2.01 Integrated Environment.

Step 2: Edit the Project file (Add the necessary library and files to the project).

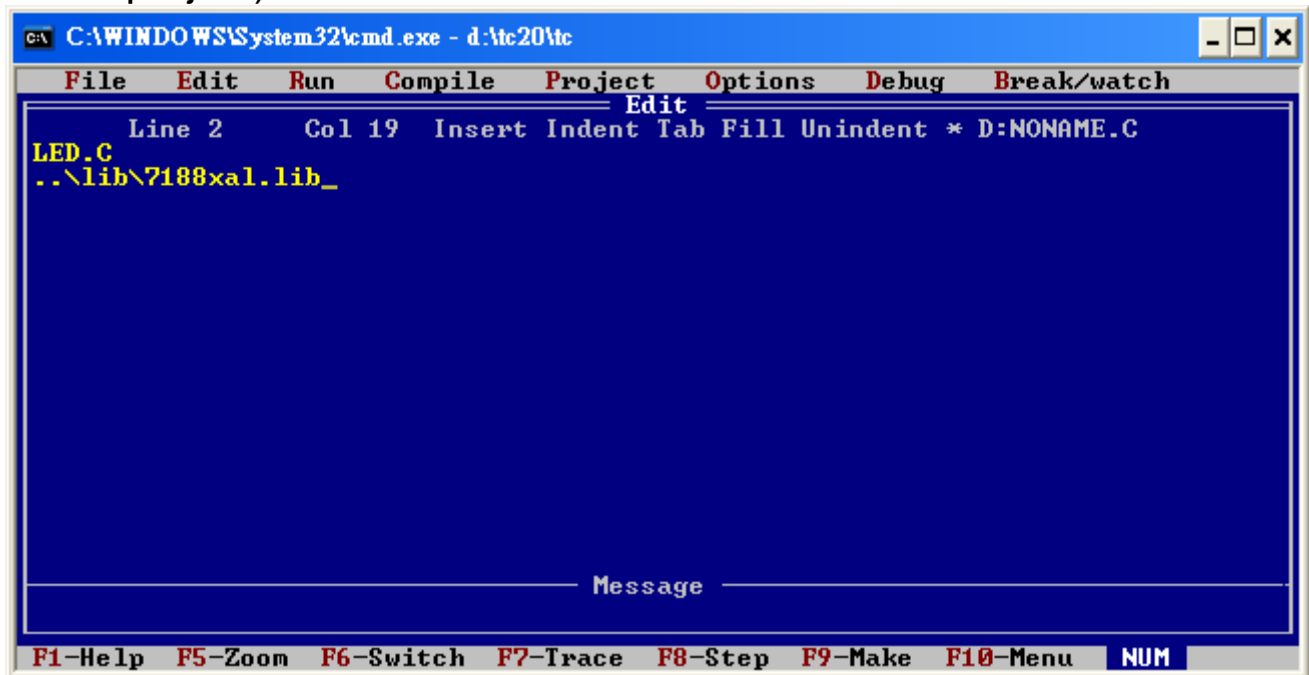

Step 3: Save the project as a Project file by selecting "save" from the File menu and entering a name, such as LED.prj.

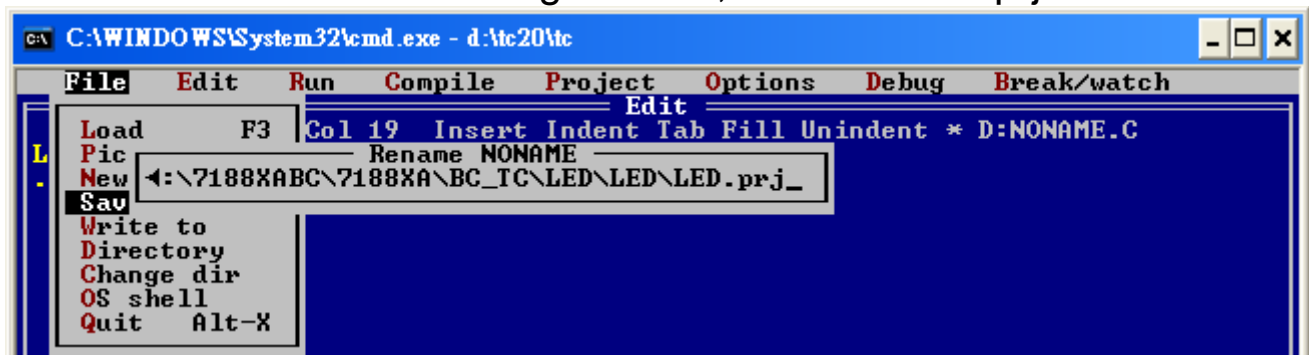

Step 4: Load the Project by selecting the project name from the Project menu.

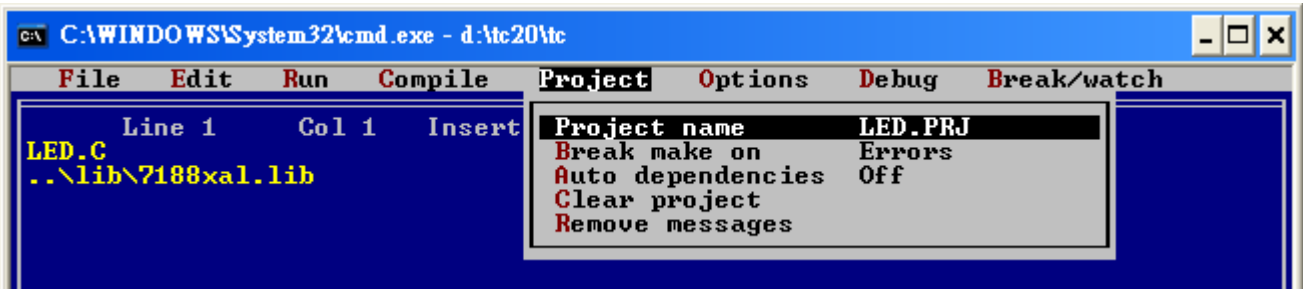

Step 5: On the compiler options menu, change the Memory model (Small for 7188xas.lib, large for 7188xa1.lib) and set the Code Generation to 80186/80286 as shown in the diagram below.

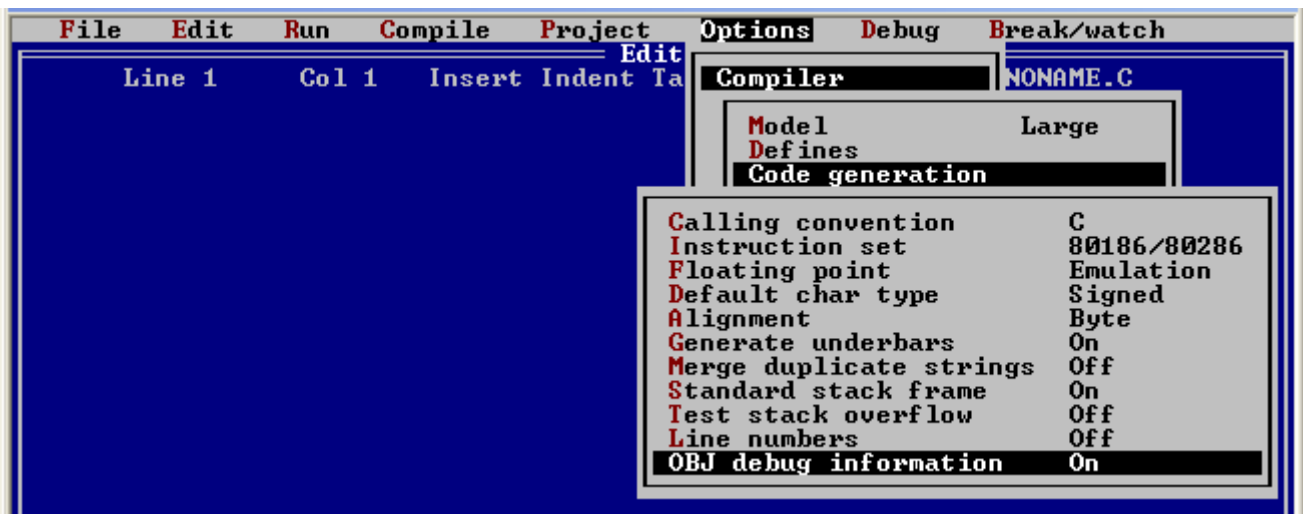
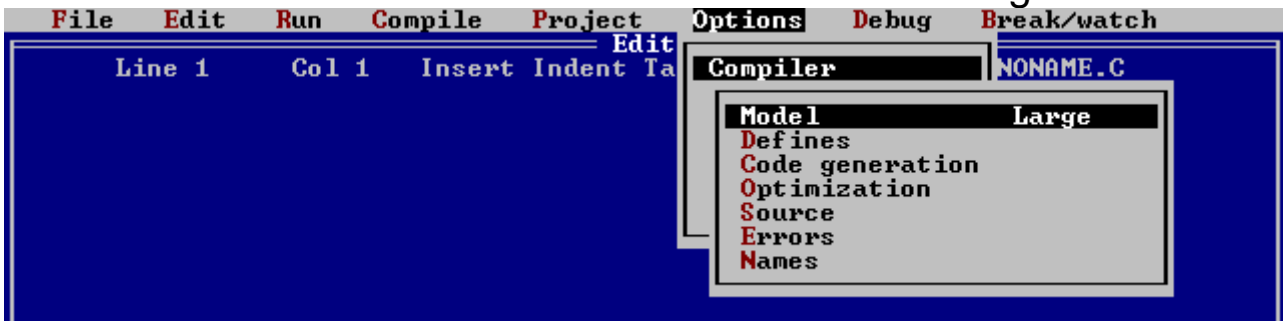

Step 6: Select "Build all" from the compile menu to build the project.

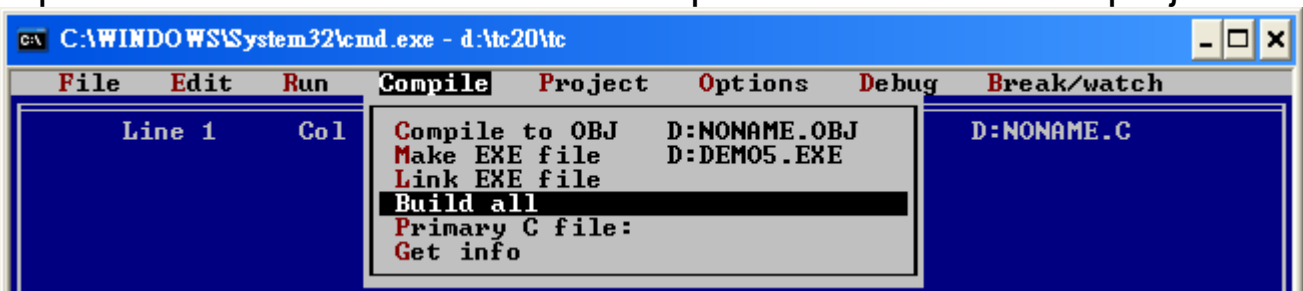

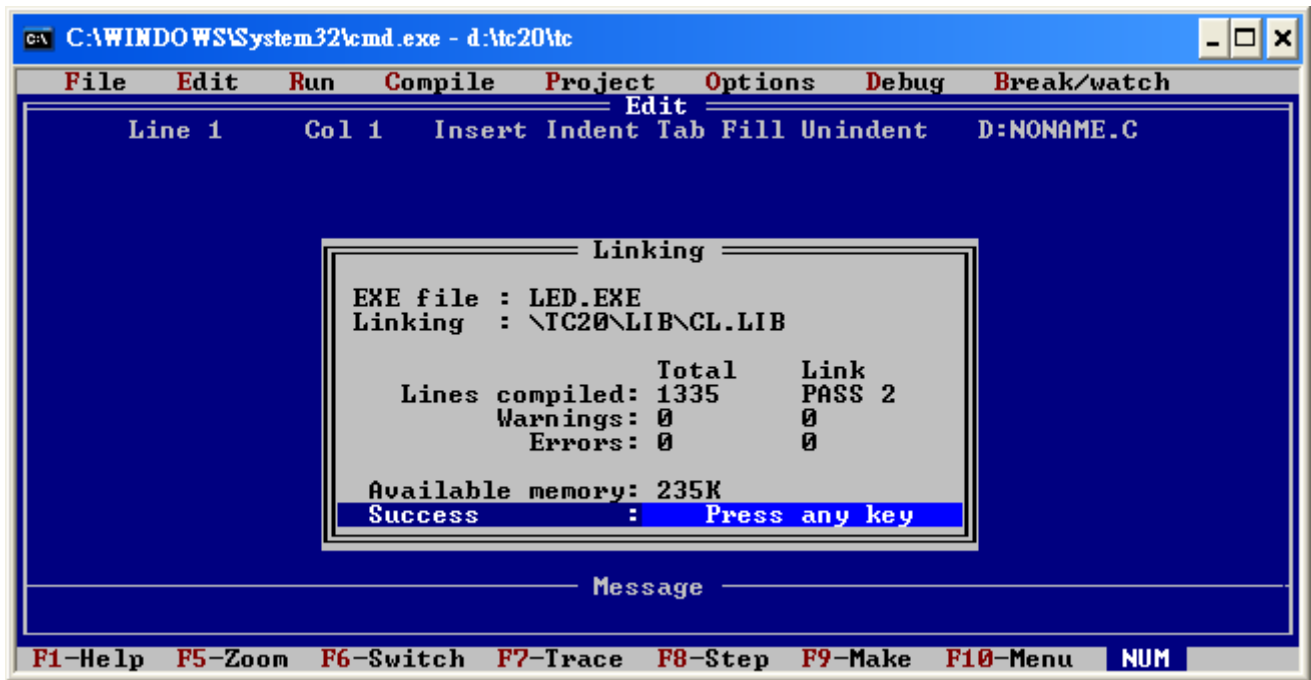

# Using the BC++ Compiler

The procedures for using the BC++ compiler is as follows:

Step 1: Execute the Borland C++ 3.1.

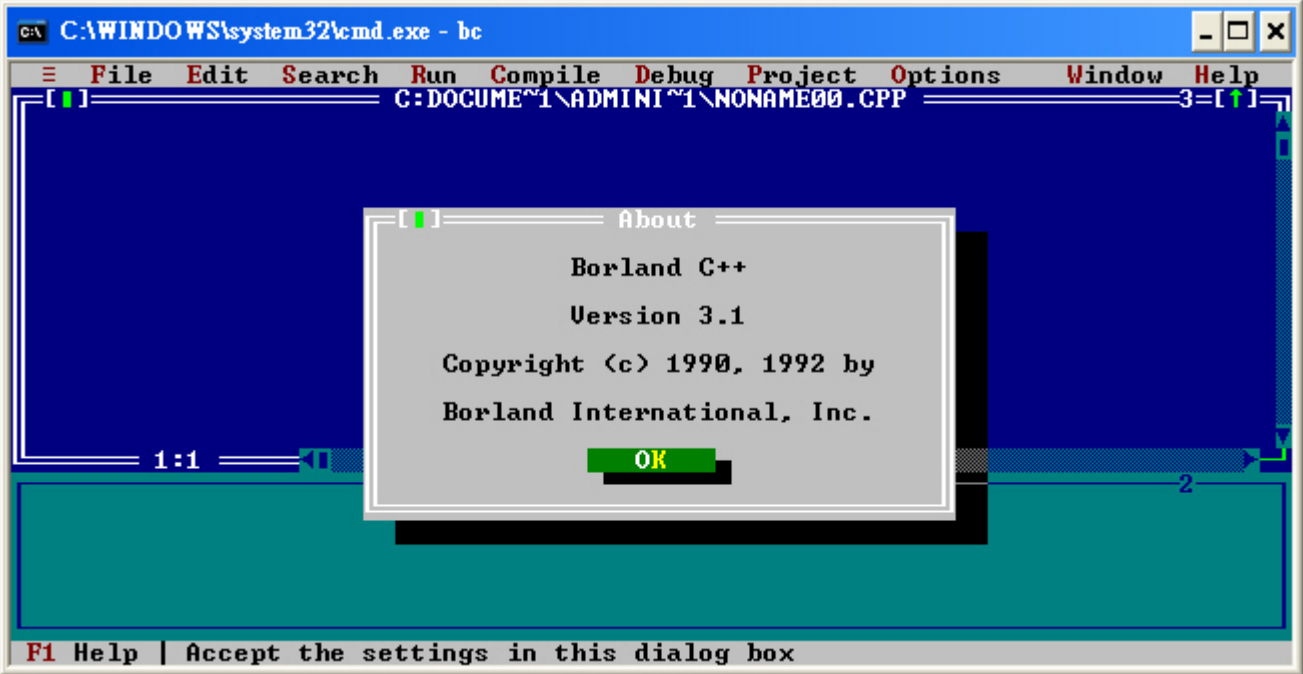

Step 2: Create a new project file (\*.prj).

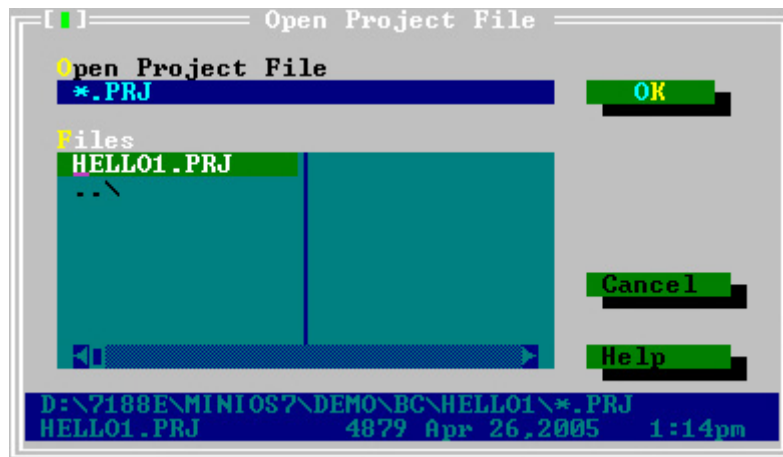
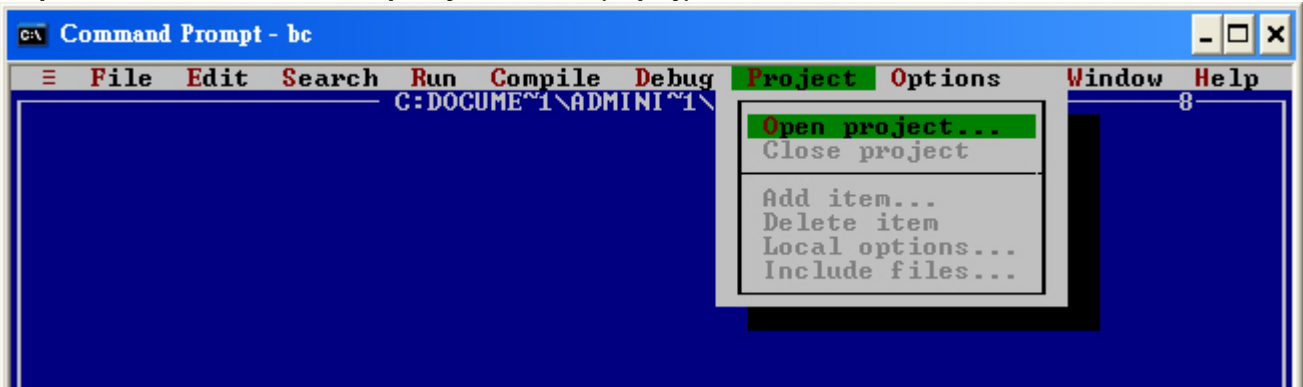

Step 3: Add all the necessary files to the project.

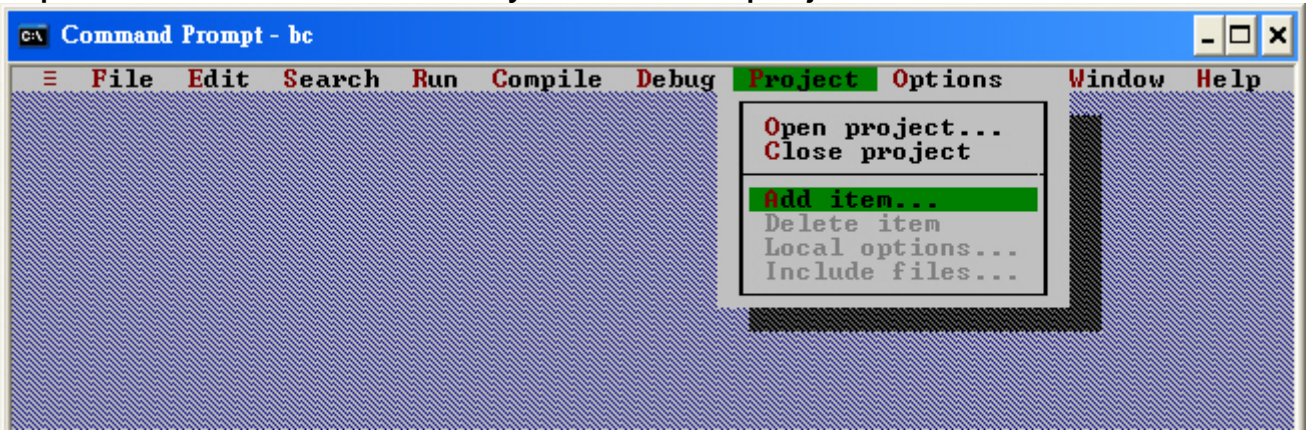

Step 3.1: Select the source file.

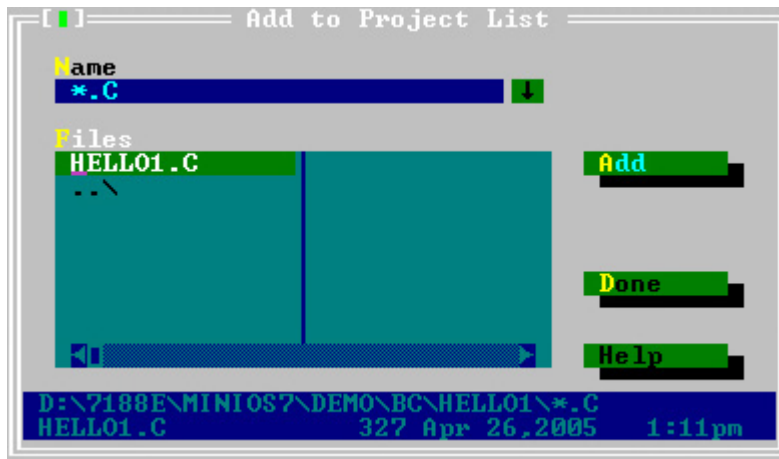

Step 3.2: Select the function library and then click the **Done** button.



Step 4: Set the Code generation options.

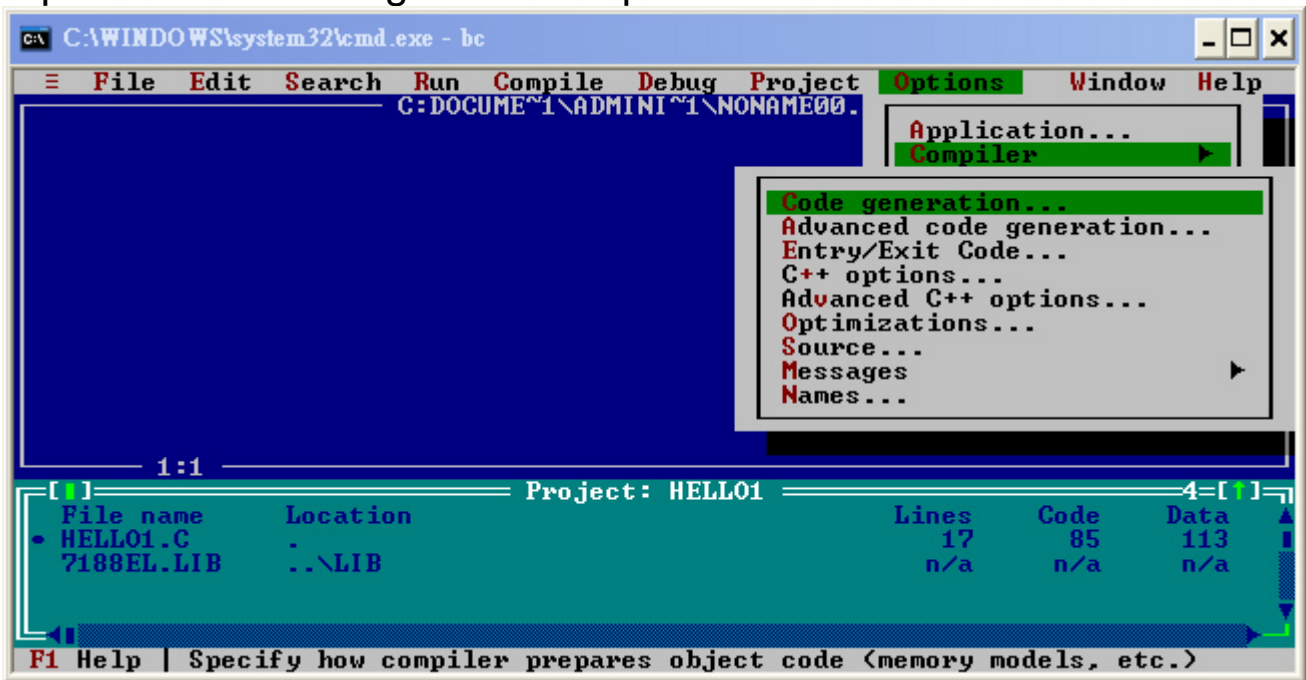

Step 4.1: Change the Memory model (Small for 7188xas.lib, large for 7188xa.lib).

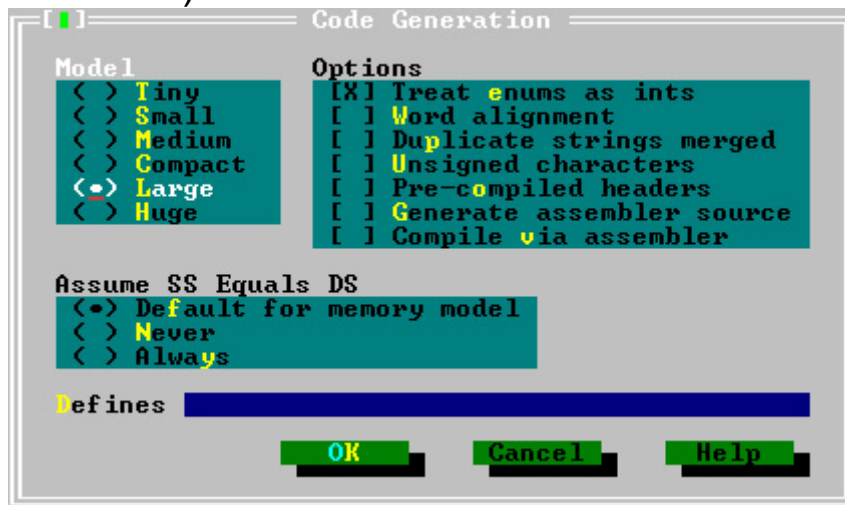

Step 5: Set the Advanced code generation options.



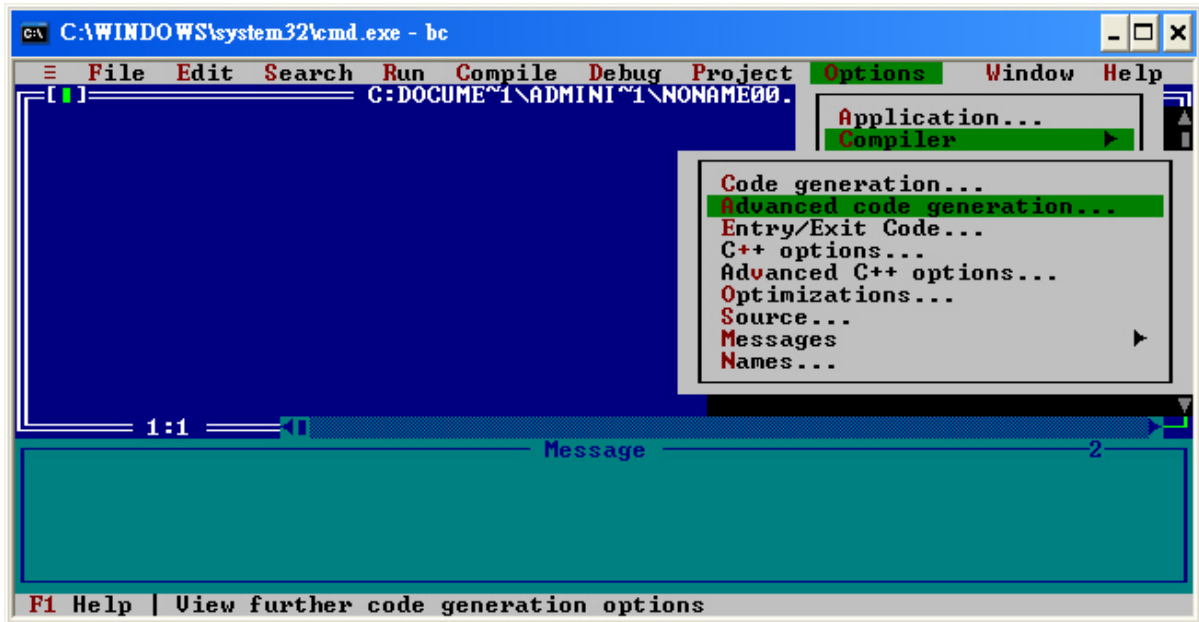

Step 5.1: Set the Floating Point to Emulation and the Instruction Set to 80186.

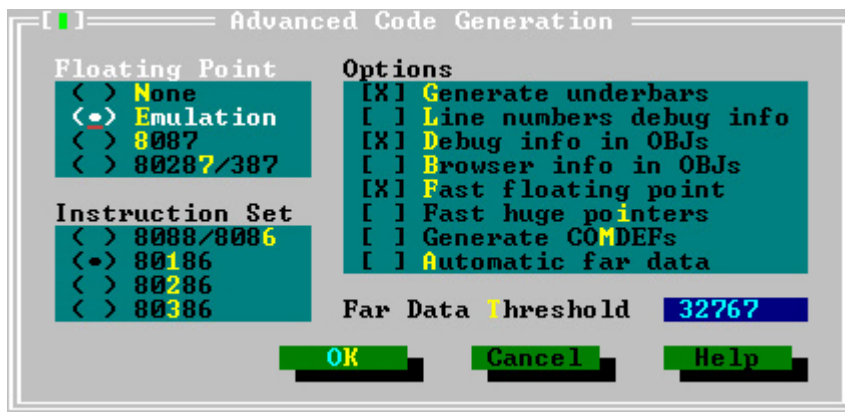

Step 6: Set the Entry/Exit Code Generation option.

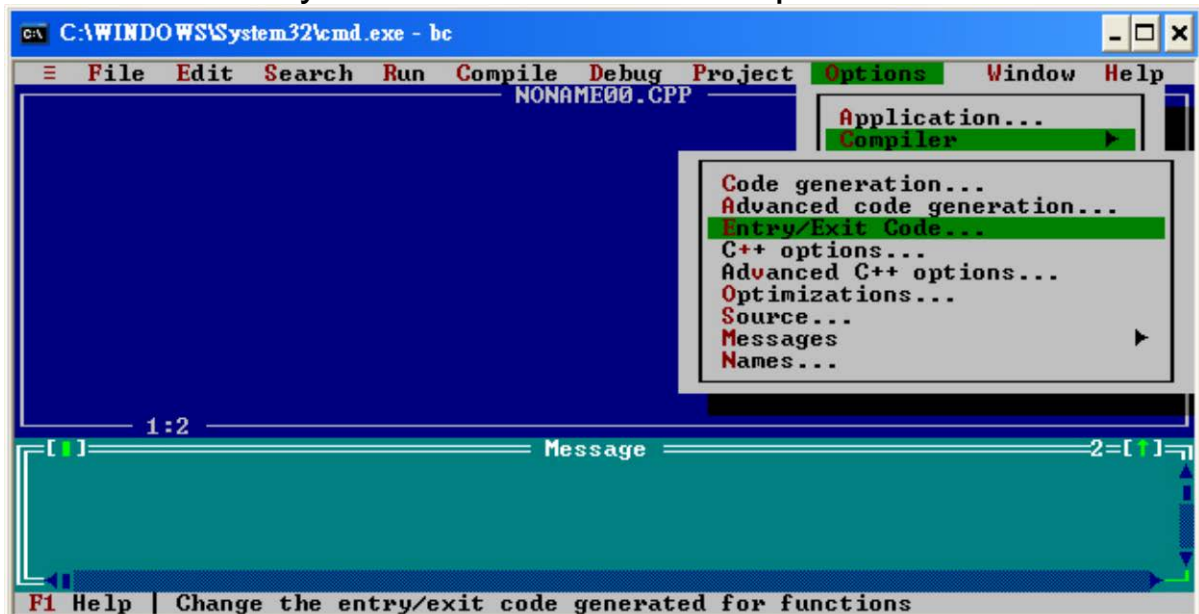



## Step 6.1: Set the DOS standard.

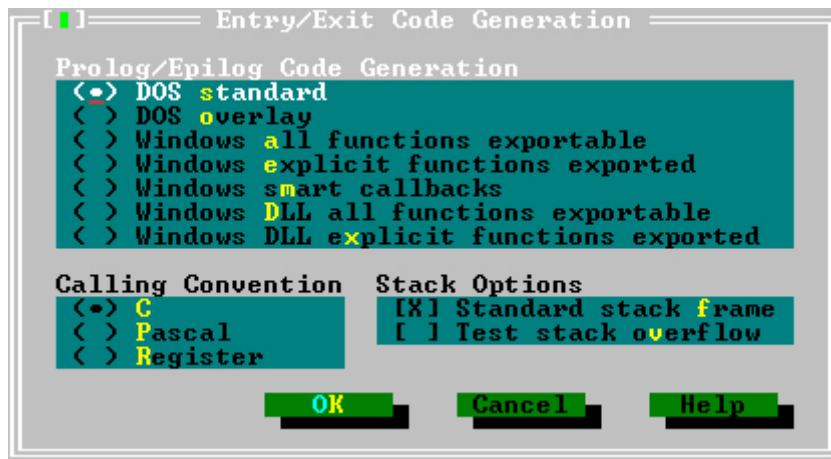

## Step 7: Set the Debugger Options.

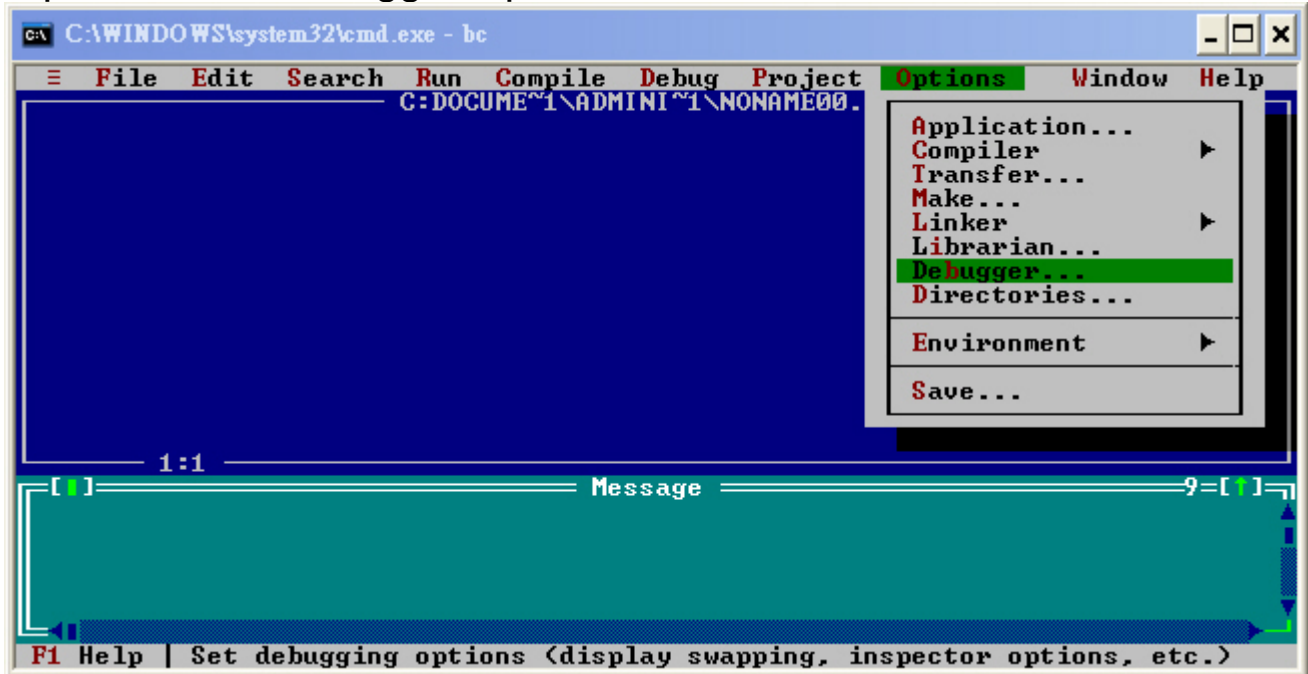

### 7.1 Set Source Debugging to None.



## Step 8: Make the project

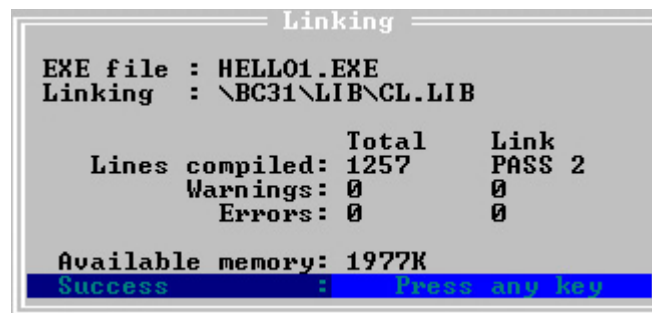
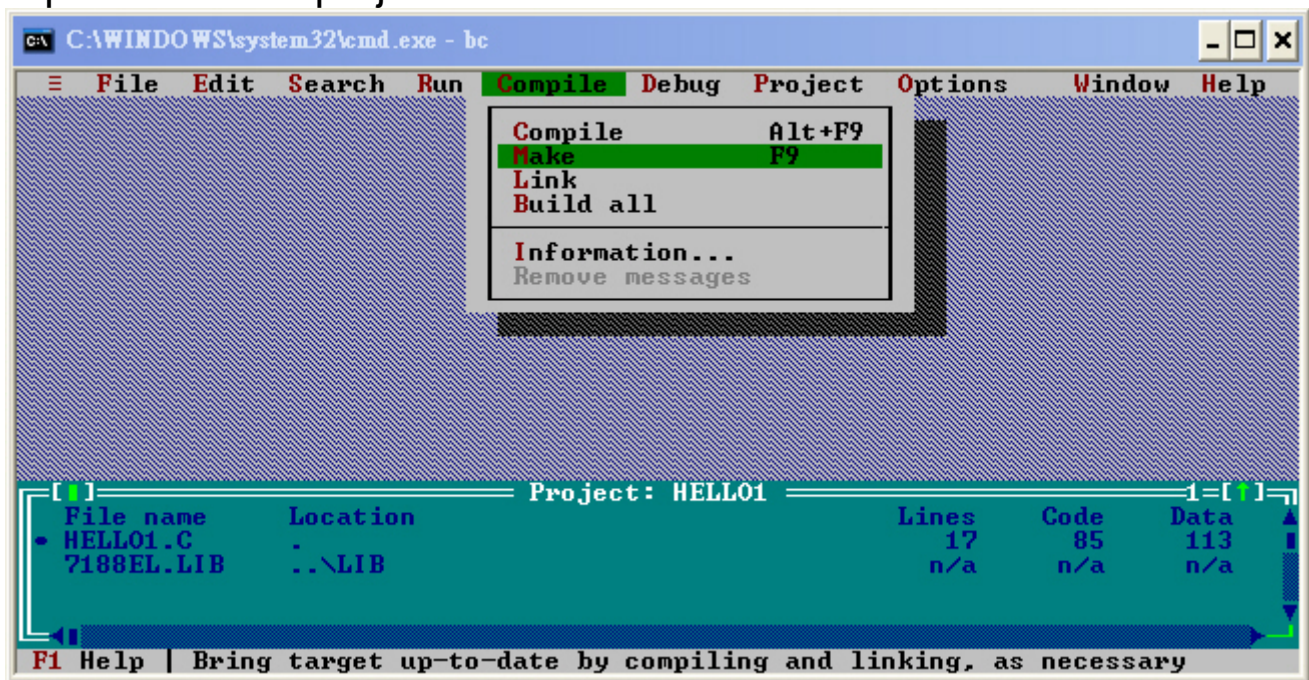

---

# Using MSC Compiler

The working steps to use MSC 6.00 Compiler are given as following:

Step 1: In the source file folder, create a batch file called Gomsc.bat using the text editor.

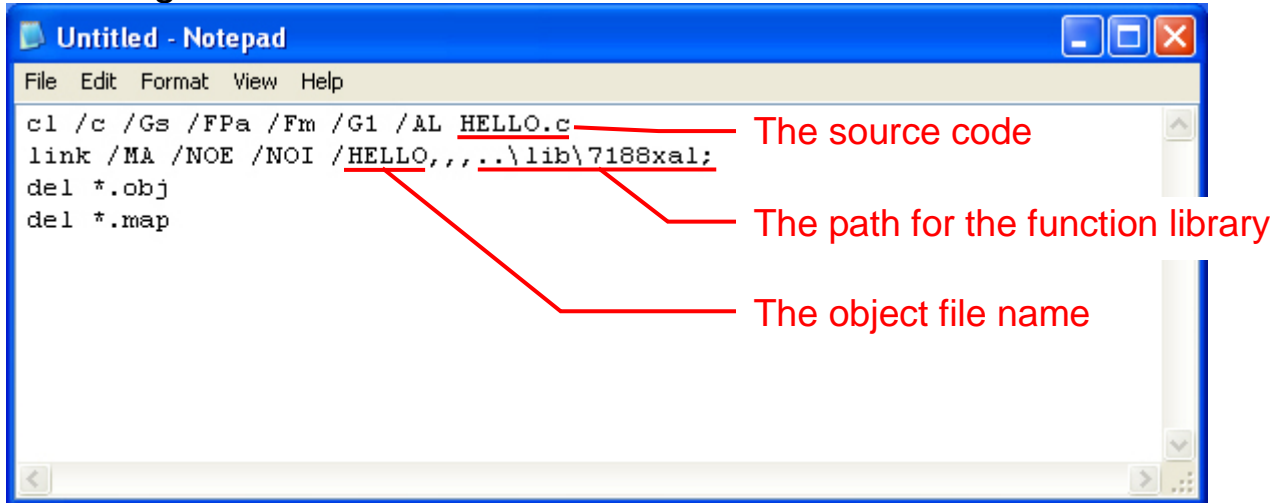

The screenshot shows a Notepad window titled "Untitled - Notepad" with the following text:

```
File Edit Format View Help
c1 /c /Gs /FPa /Fm /G1 /AL HELLO.c
link /MA /NOE /NOI /HELLO,,,\lib\7188xa1;
del *.obj
del *.map
```

Red lines point from the text to the following annotations:

- "The source code" points to `HELLO.c`
- "The path for the function library" points to `\\lib\7188xa1;`
- "The object file name" points to `HELLO`

**NOTE:** /C: don't strip comments  
/Gs: no stack checking  
/Fpa: calls with altmath  
/Fm: [map file]  
/G1: 186 instructions  
/AL: large model

Step 2: Run the Gomsc.bat file.



The screenshot shows a command prompt window titled "C:\WINDOWS\System32\cmd.exe" with the following text:

```
C:\7188XA\Demo\MSC\Hello>Gomsc
C:\7188XA\Demo\MSC\Hello>c1 /c /Gs /FPa /Fm /G1 /AL Hello.c
Microsoft (R) C Optimizing Compiler Version 6.00
Copyright (c) Microsoft Corp 1984-1990. All rights reserved.
Hello.c
C:\7188XA\Demo\MSC\Hello>link /MA /NOE /NOI Hello,,,\lib\7188xa1;
Microsoft (R) Segmented-Executable Linker Version 5.10
Copyright (C) Microsoft Corp 1984-1990. All rights reserved.
C:\7188XA\Demo\MSC\Hello>del *.obj
C:\7188XA\Demo\MSC\Hello>del *.map
C:\7188XA\Demo\MSC\Hello>_
```

Step 3: A new executable file will be created if it is successfully compiled.

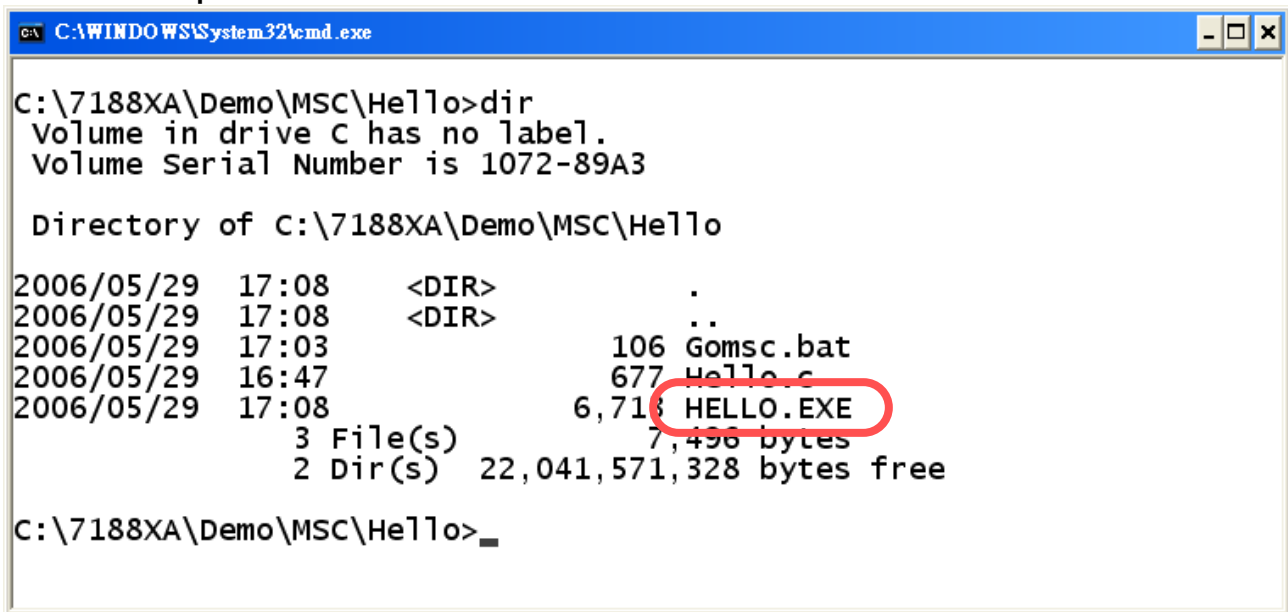

```
C:\WINDOWS\System32\cmd.exe
C:\7188XA\Demo\MSC\Hello>dir
Volume in drive C has no label.
Volume Serial Number is 1072-89A3

Directory of C:\7188XA\Demo\MSC\Hello

2006/05/29  17:08    <DIR>          .
2006/05/29  17:08    <DIR>          ..
2006/05/29  17:03             106 Gomsc.bat
2006/05/29  16:47             677 Hello.c
2006/05/29  17:08             6,716 HELLO.EXE
                3 File(s)      7,496 bytes
                2 Dir(s)  22,041,571,328 bytes free

C:\7188XA\Demo\MSC\Hello>
```

# Using MSVC++ Compiler

The working steps to use MSVC 1.50 compiler are given as following:

Step 1: Run MSVC.exe



Step 2: Create a new project (\*.mak) by entering the name of the project in the Project Name field and then select MS-DOS application (EXE) as the Project type.

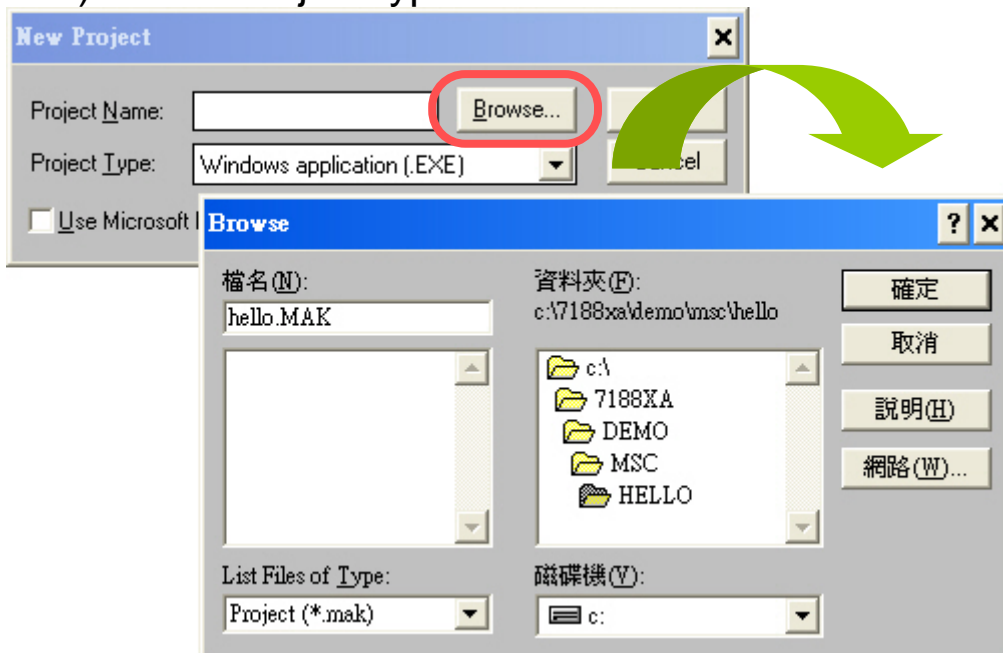

Step 3: Add the user's program and the necessary library files to the project.

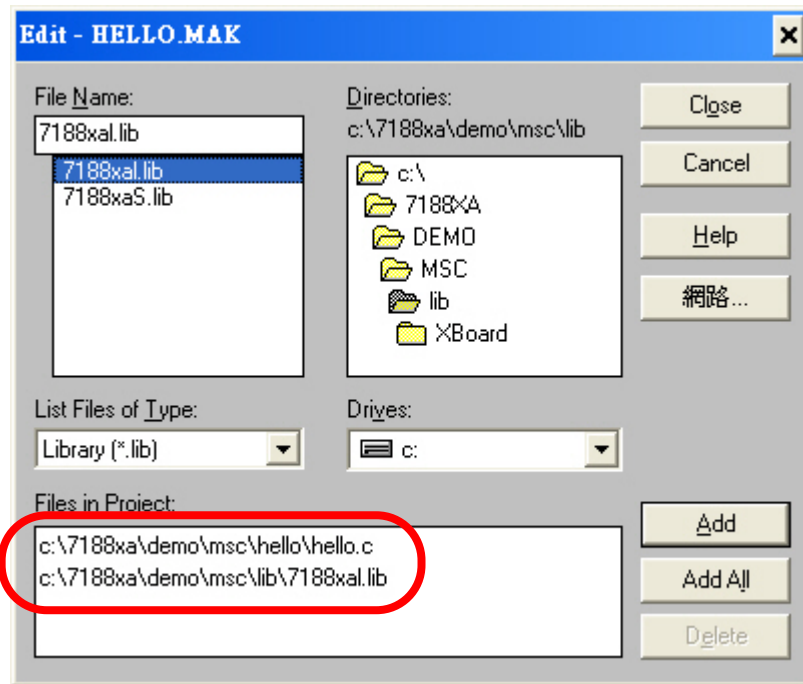

Step 4: Set the Code Generation on the Compiler.

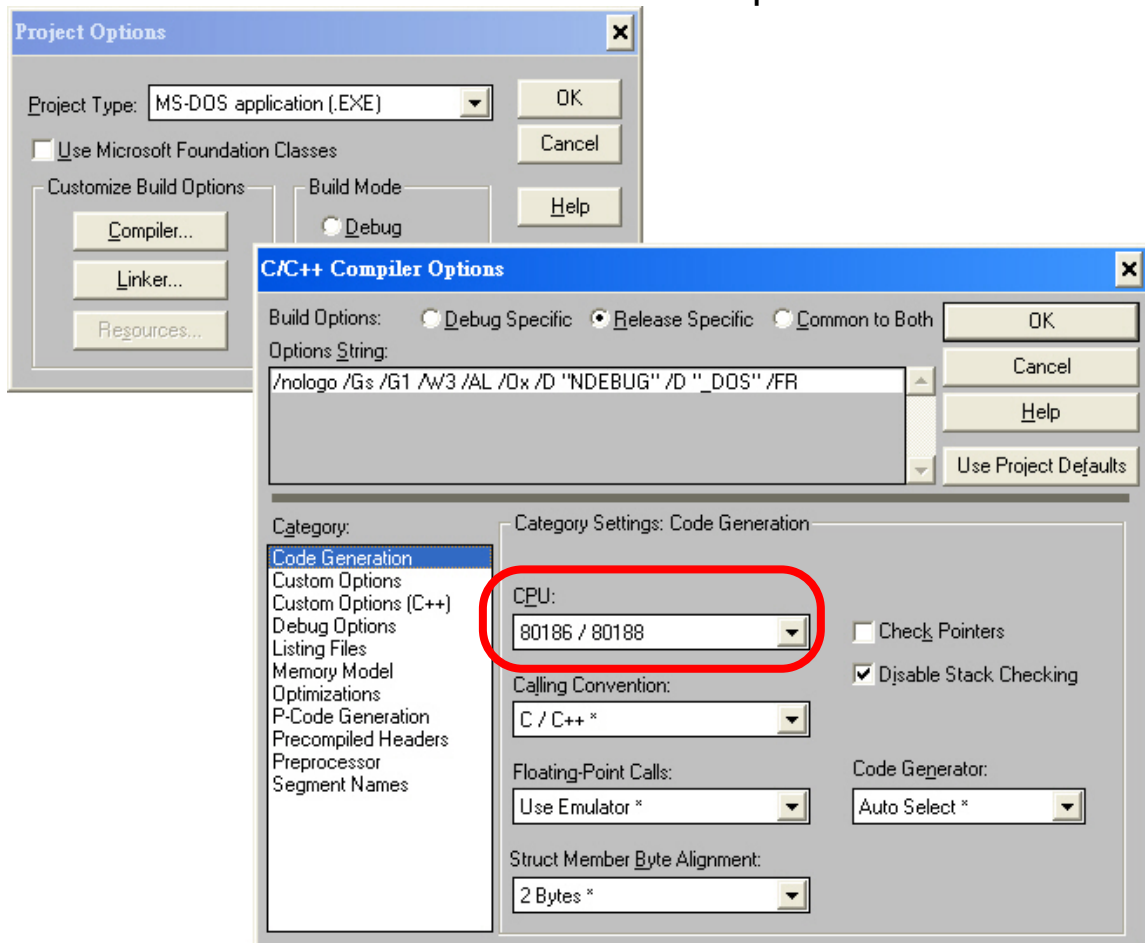



Step 5: Change the Memory model (Small for 7188xas.lib, large for 7188xa.lib).

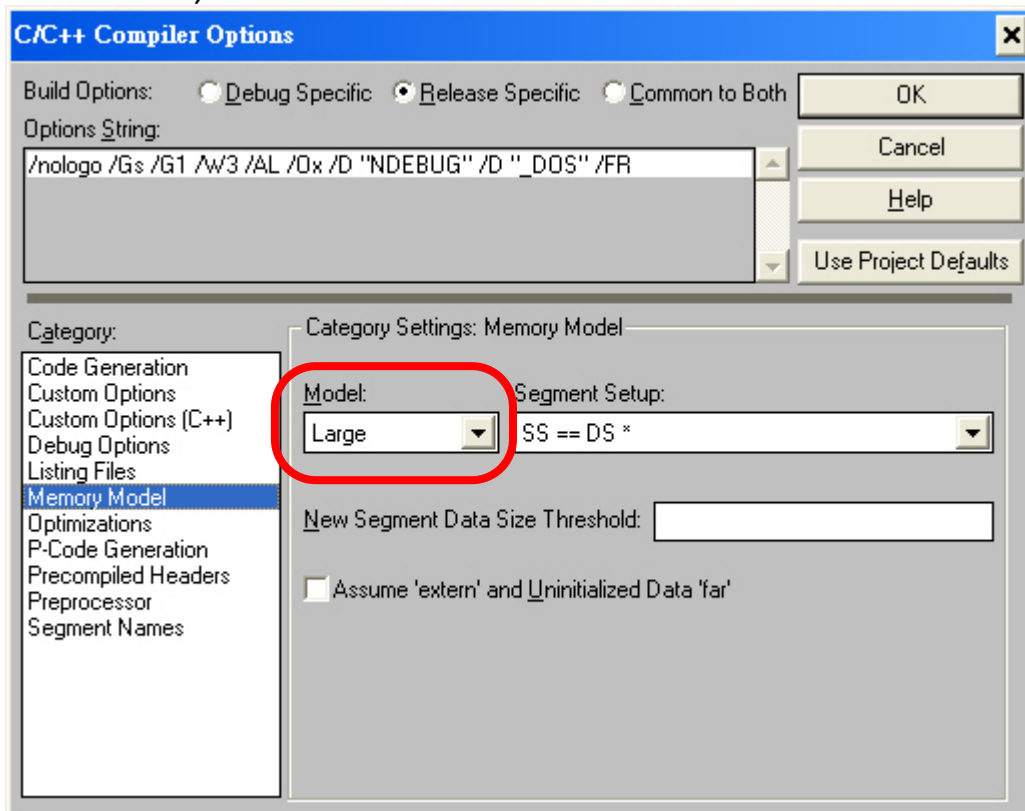

Step 6: Remove the xcr, afxcr library from the Input Category.

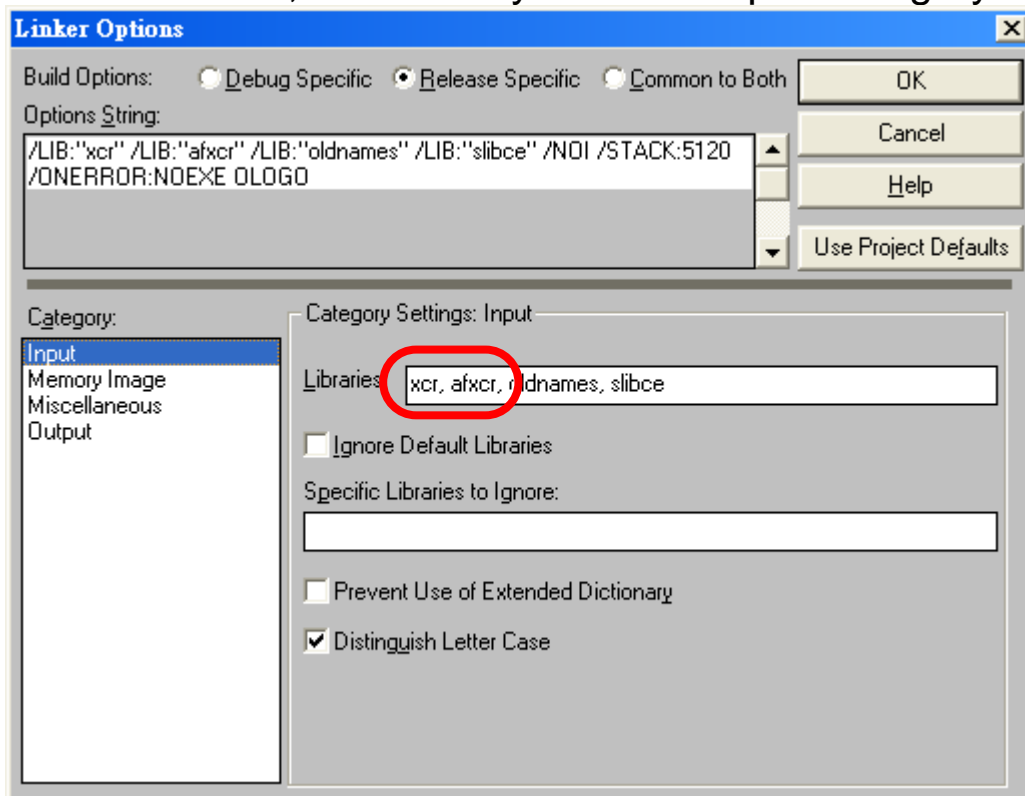

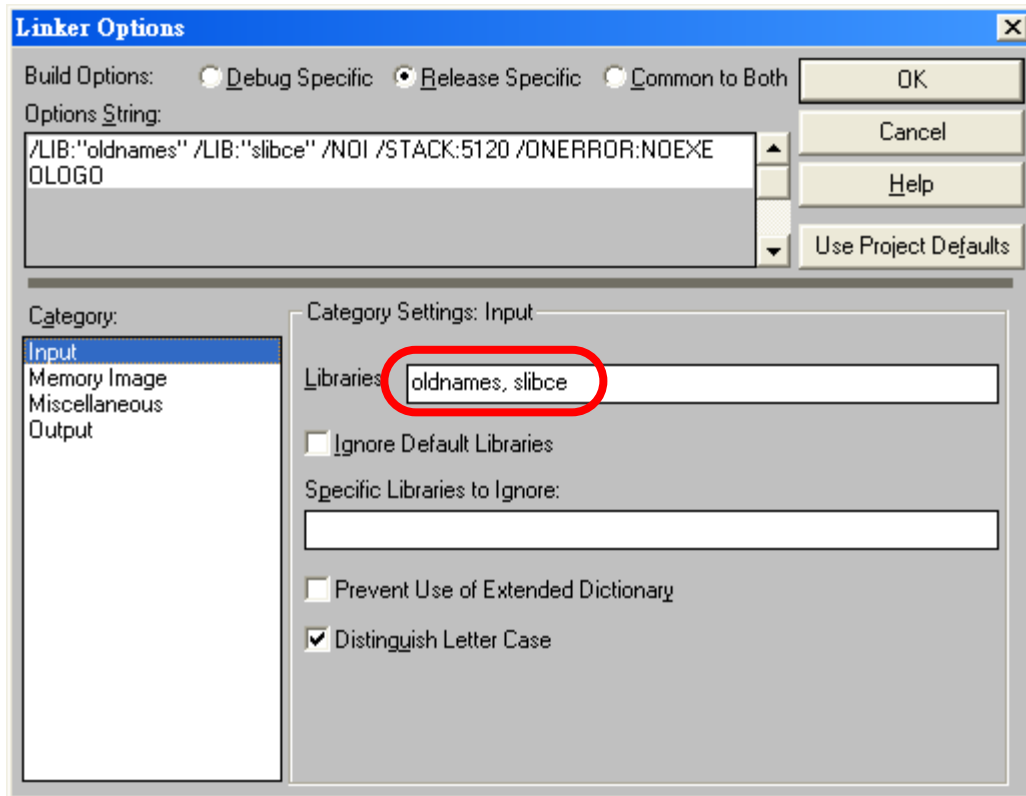

Step 7: Remove the OLOGO option from the miscellaneous Category.

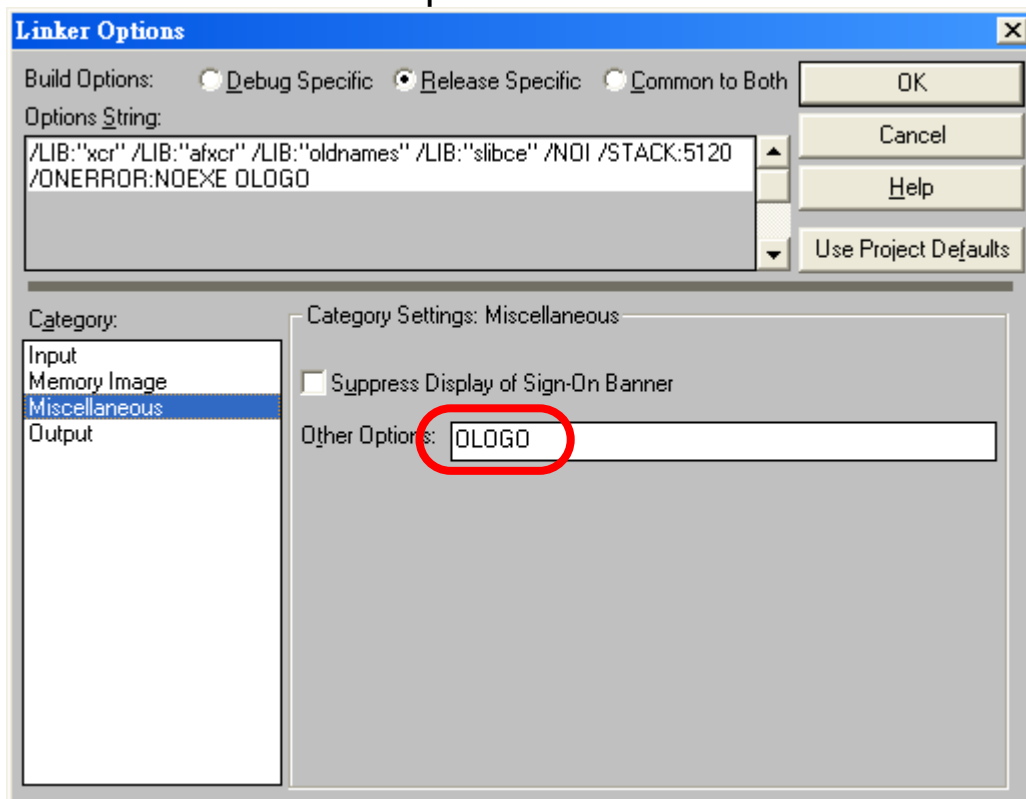



## Step 8: Rebuild the project.

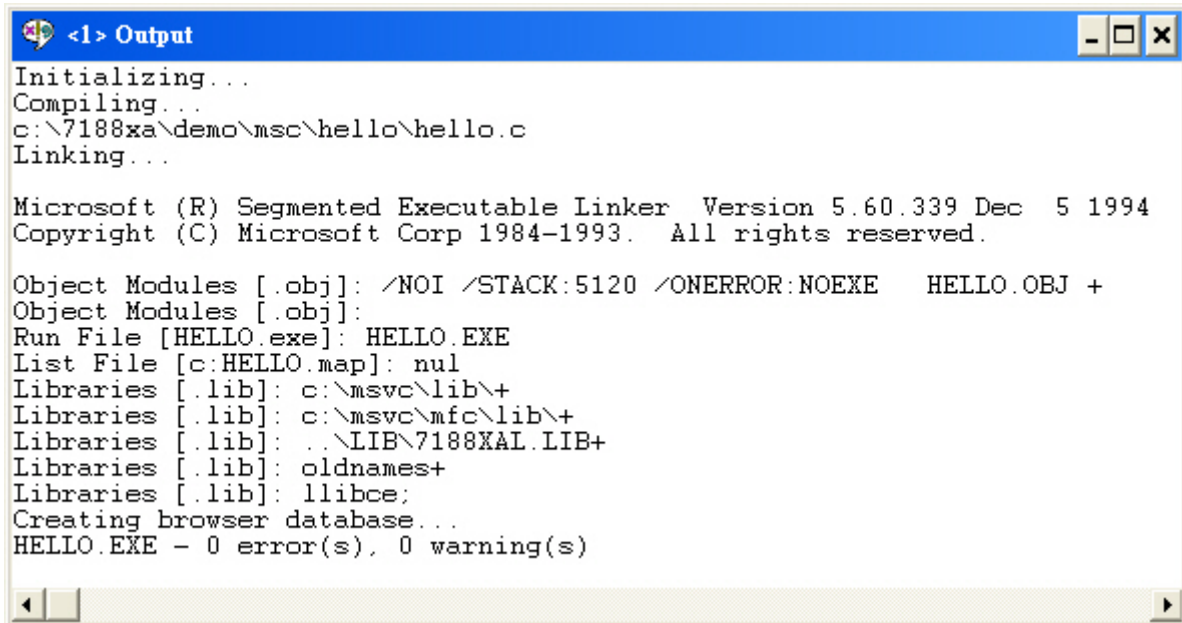
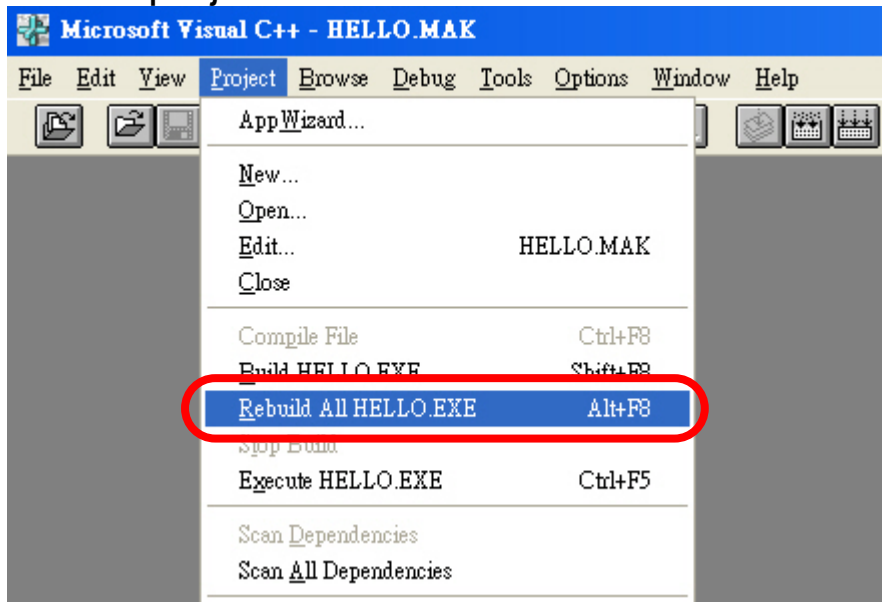

---

# Compiling on 64-bit platform like Windows 7 or Windows 8 / 8.1

## Preface:

If we try to use 16-bit compiler like BC3.1 or TC++3.0 to build MiniOS7 project on Windows 64-bit platform like Windows 7 or Windows 8, it will prompt up an error message to show compatibility problem for 64-bit platform.

“Application can’t run on your PC. Contact with your software publisher” Or like below snap shot.

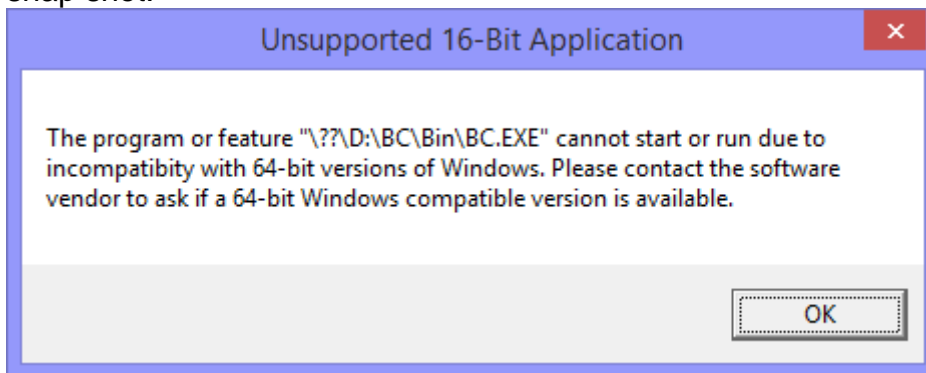

**Please follow below steps to solve the problem.**

**Step 1:** download and install DosBox for Windows. You can easily install the 32 bit version on a 64-bit OS. The download page is here:

<http://sourceforge.net/projects/dosbox/files/dosbox/0.74/DOSBox0.74-win32-installer.exe/download>

Note: Strongly recommend installing DOSBox as administrator.

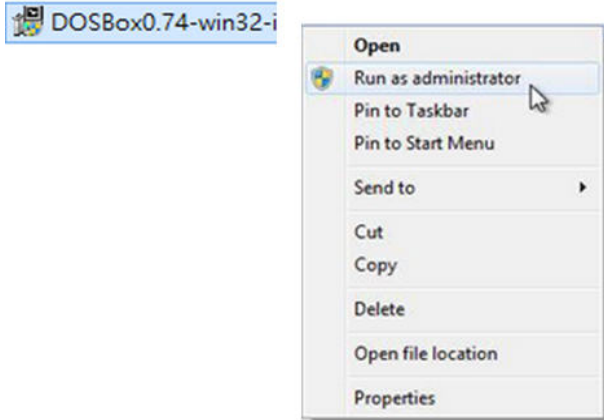

**Step 2:** Start up the DOSBox, click DOSBox, it will bring out two Windows forms, one is DOSBox Status Window and DOSBox Console as below.

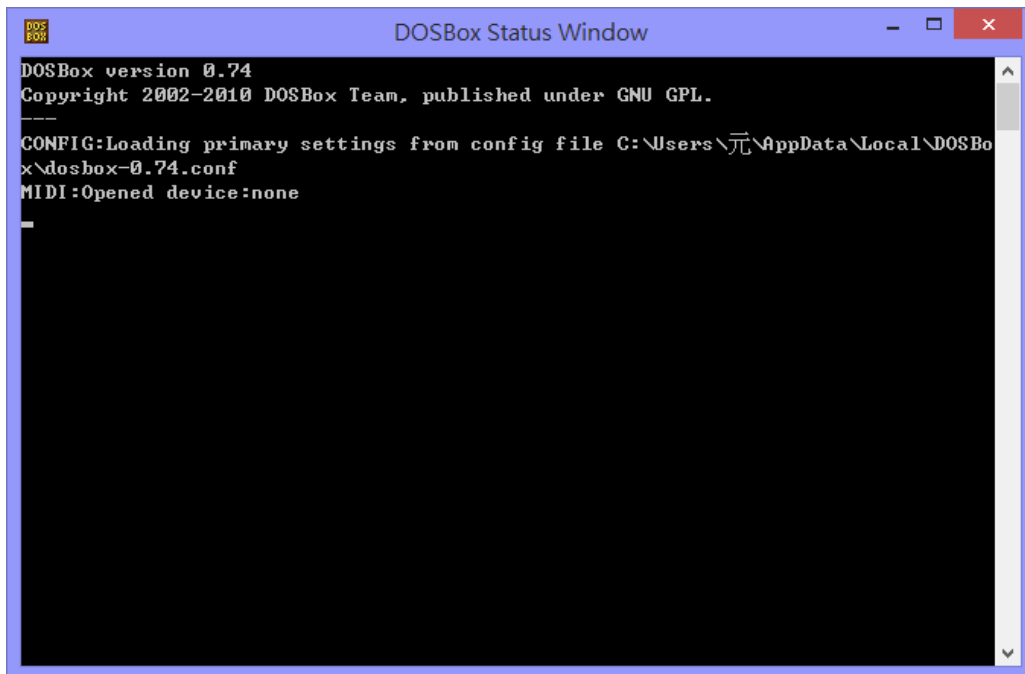

First use command “CLS” or “cls” to clear the screen.

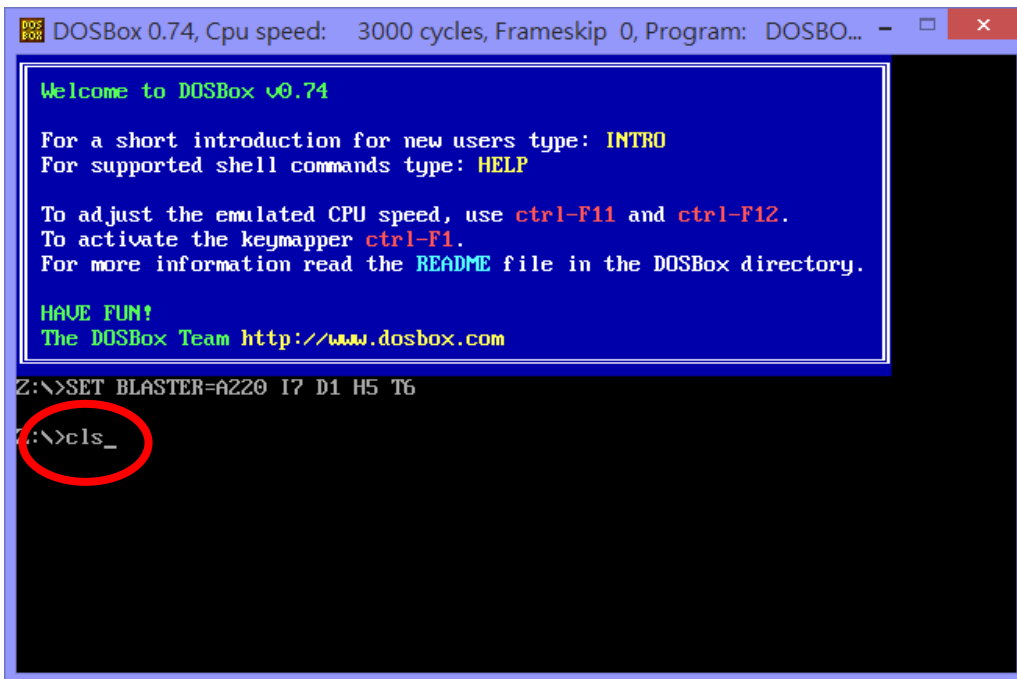

```
DOSBox 0.74, Cpu speed: 3000 cycles, Frameskip 0, Program: DOSBO... - □ ×  
Welcome to DOSBox v0.74  
For a short introduction for new users type: INTRO  
For supported shell commands type: HELP  
To adjust the emulated CPU speed, use ctrl-F11 and ctrl-F12.  
To activate the keymapper ctrl-F1.  
For more information read the README file in the DOSBox directory.  
HAVE FUN!  
The DOSBox Team http://www.dosbox.com  
Z:\>SET BLASTER=A220 I7 D1 H5 T6  
Z:\>cls_
```

**Step 3:** Configure the DOSBox Environments settings.

1. Make sure the demo file path, for example D:\MiniOS7\hello\hello\_c
2. Make sure the BC\Bin file path, for example D:\BC\Bin
3. Use mount command to mount the disk driver for example “mount d d:”
4. After mount disk driver D, then type “D:” to change “Z:\>” to “D:\>”.
5. Set Path to BC\Bin for example “path d:\bc\bin”
6. Change directory to demo run “bc”

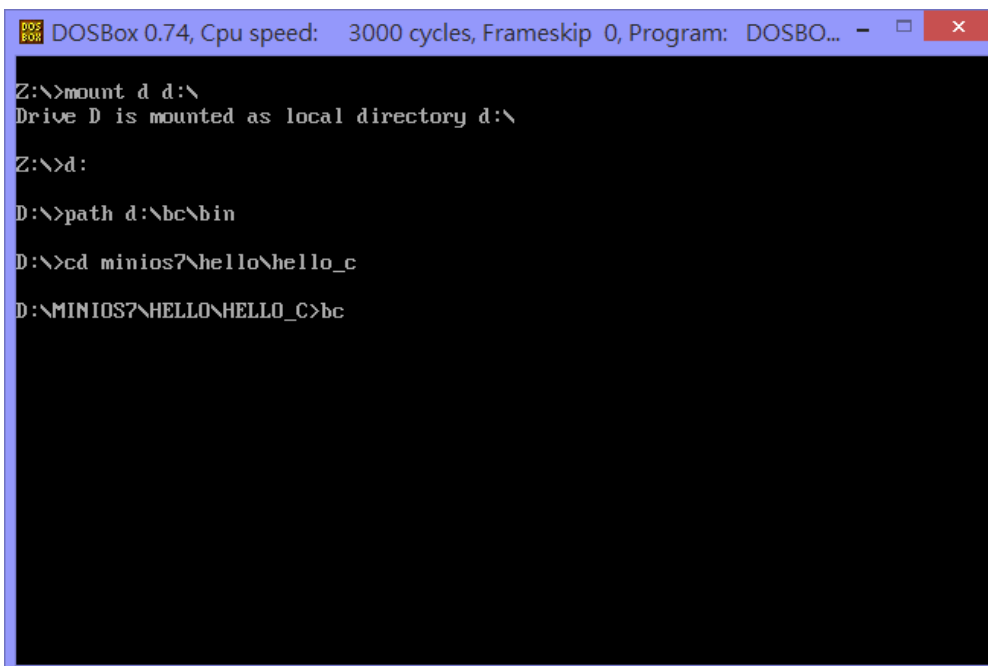

```
DOSBox 0.74, Cpu speed: 3000 cycles, Frameskip 0, Program: DOSBO... - □ ×  
Z:\>mount d d:\  
Drive D is mounted as local directory d:\  
Z:\>d:  
D:\>path d:\bc\bin  
D:\>cd minios7\hello\hello_c  
D:\MINIOS7\HELLO\HELLO_C>bc
```

**Step 4:** Press “Project” to open project → Press “Compile” to build the project.

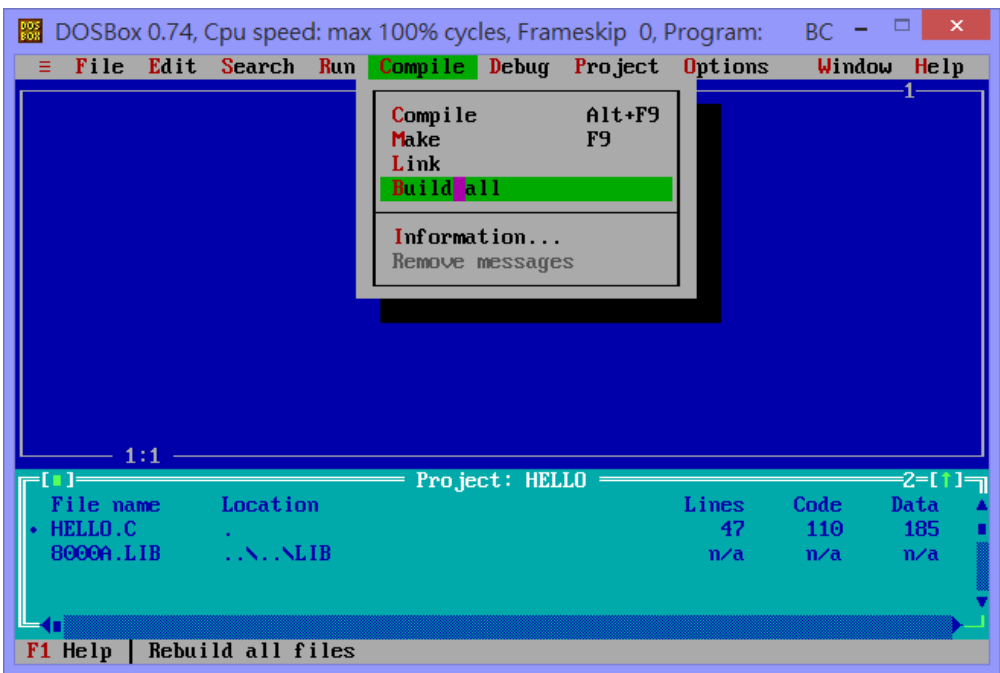
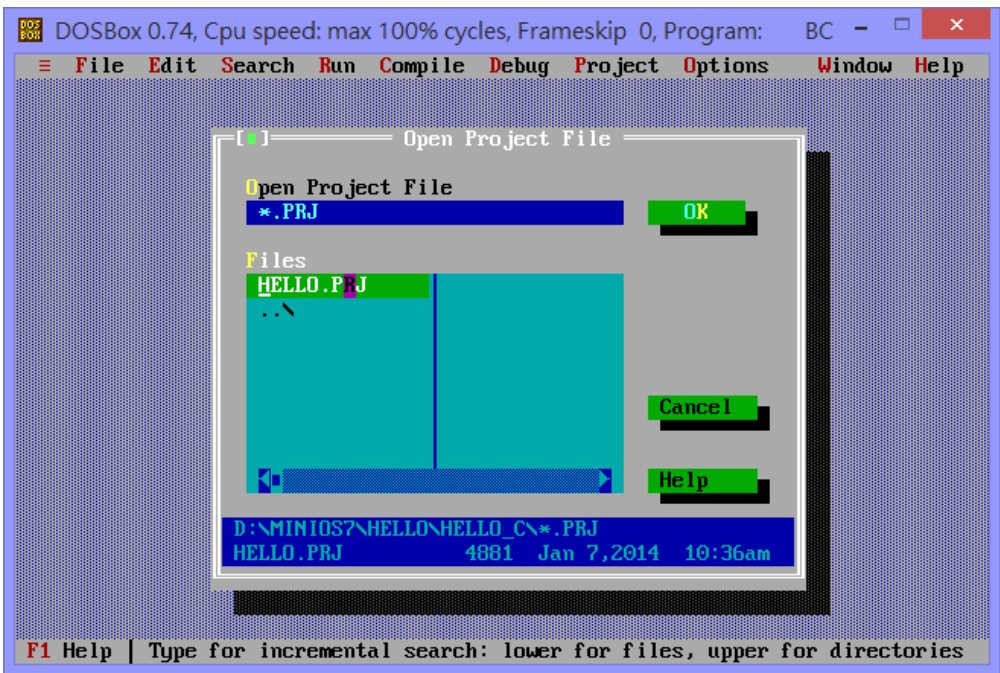

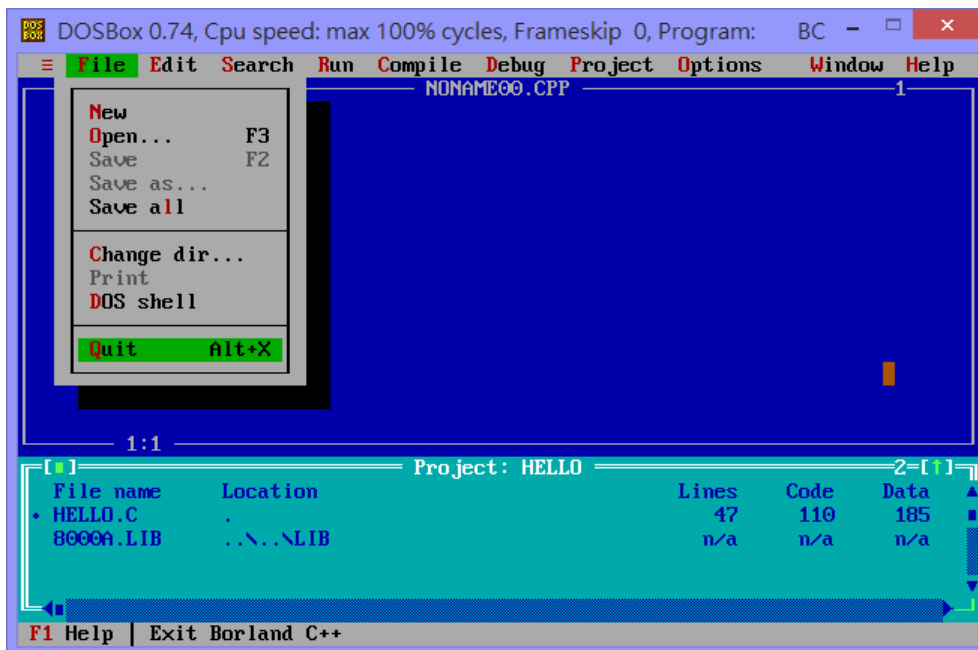
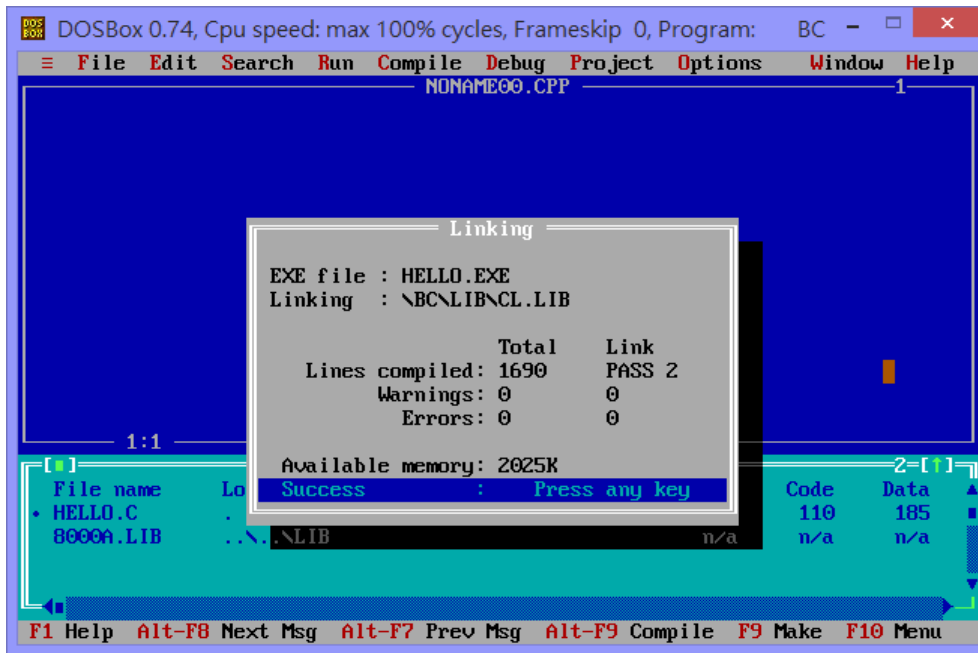

---

### Tips for using batch file:

It is a little troublesome to set the path and launch the BC demo project, We can make a batch file as below for demo program,

```
path d:\bc\bin
cd minios7\hello\hello_c
bc
```

and save this batch file to path "D:\", when Driver D is mounted as local directory and change to d: ,

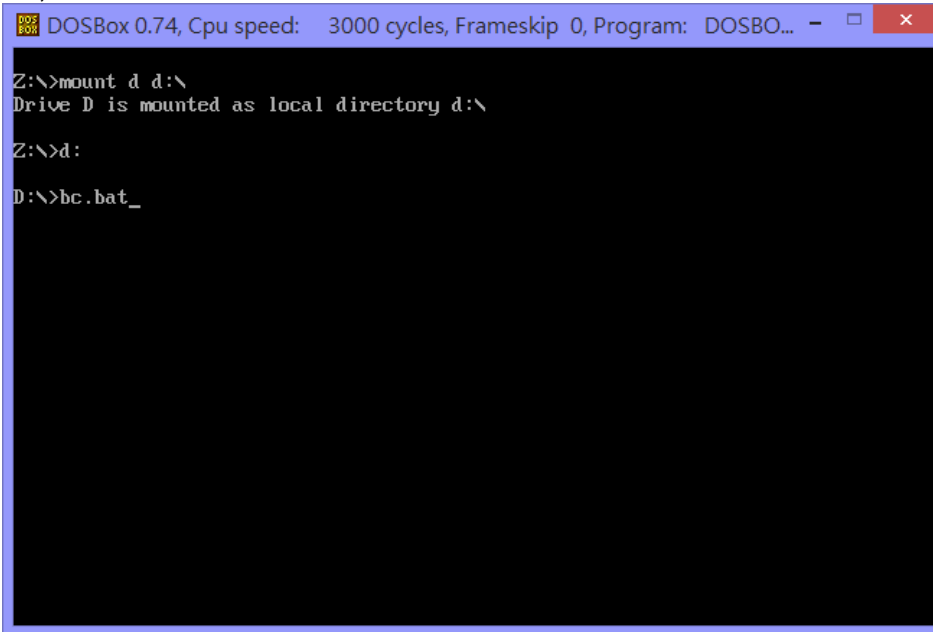

```
DOSBox 0.74, Cpu speed: 3000 cycles, Frameskip 0, Program: DOSBO...
Z:\>mount d d:\
Drive D is mounted as local directory d:\
Z:\>d:
D:\>bc.bat_
```

After execute the bc.bat file, the demo project will be launched successfully.

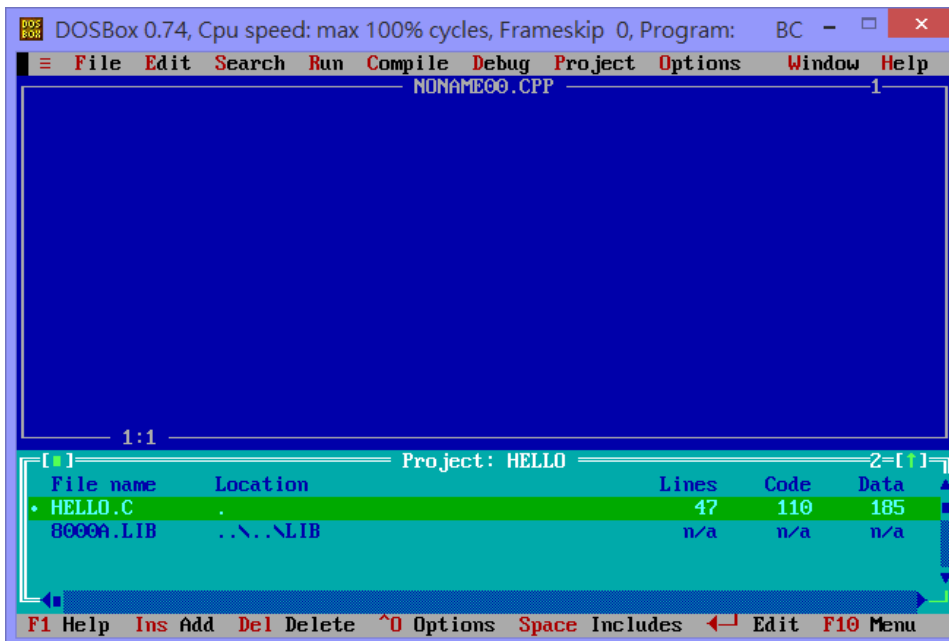

```
DOSBox 0.74, Cpu speed: max 100% cycles, Frameskip 0, Program: BC
File Edit Search Run Compile Debug Project Options Window Help
NONAME00.CPP 1
1:1
Project: HELLO
File name Location Lines Code Data
HELLO.C . 47 110 185
80000.LIB ..\..\LIB n/a n/a n/a
F1 Help Ins Add Del Delete ^O Options Space Includes Edit F10 Menu
```

---

If BC3.1 compiler is not available, it can download Free TurboC++3.0 from website  
Download Free [turboc.zip](http://www.bestfreewaredownload.com/download/t-free-turbo-c--freeware-flggsdpz.html) from following link  
<http://www.bestfreewaredownload.com/download/t-free-turbo-c--freeware-flggsdpz.html>



After unzip the turboc.zip and copy the turboc folder to D:\, then start up the DOSBox, and run the install.exe to install TC++3.0

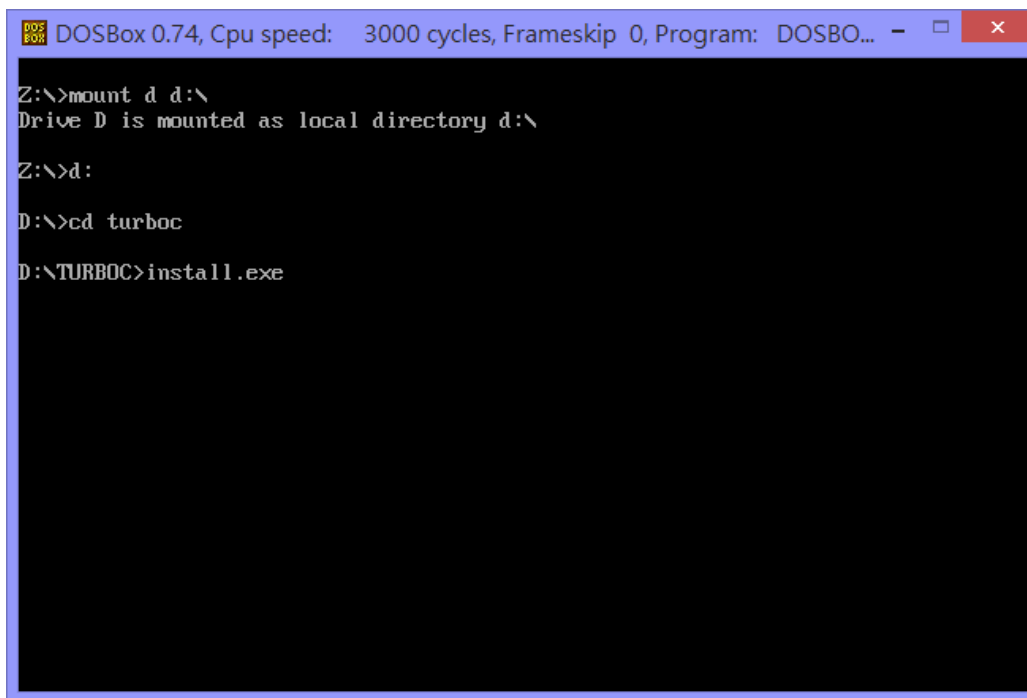

```
DOSBox 0.74, Cpu speed: 3000 cycles, Frameskip 0, Program: DOSBO...
Z:\>mount d d:\
Drive D is mounted as local directory d:\
Z:\>d:
D:\>cd turboc
D:\TURBOC>install.exe
```



Below snap shots are steps for install TC++ 3.0

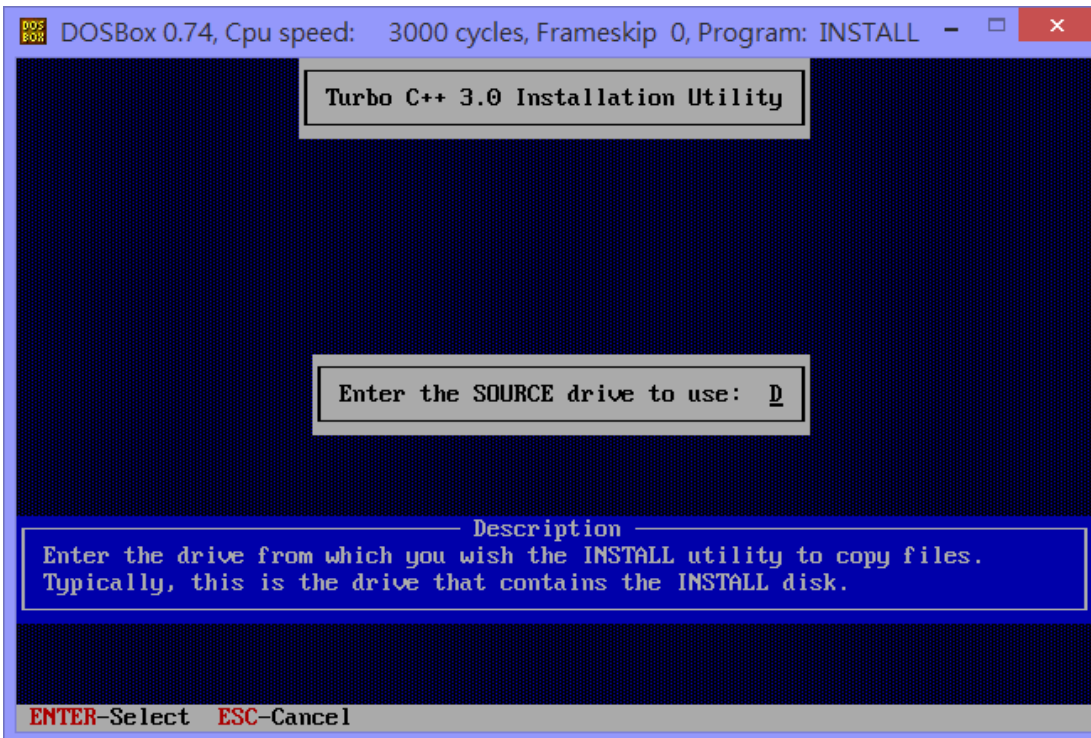
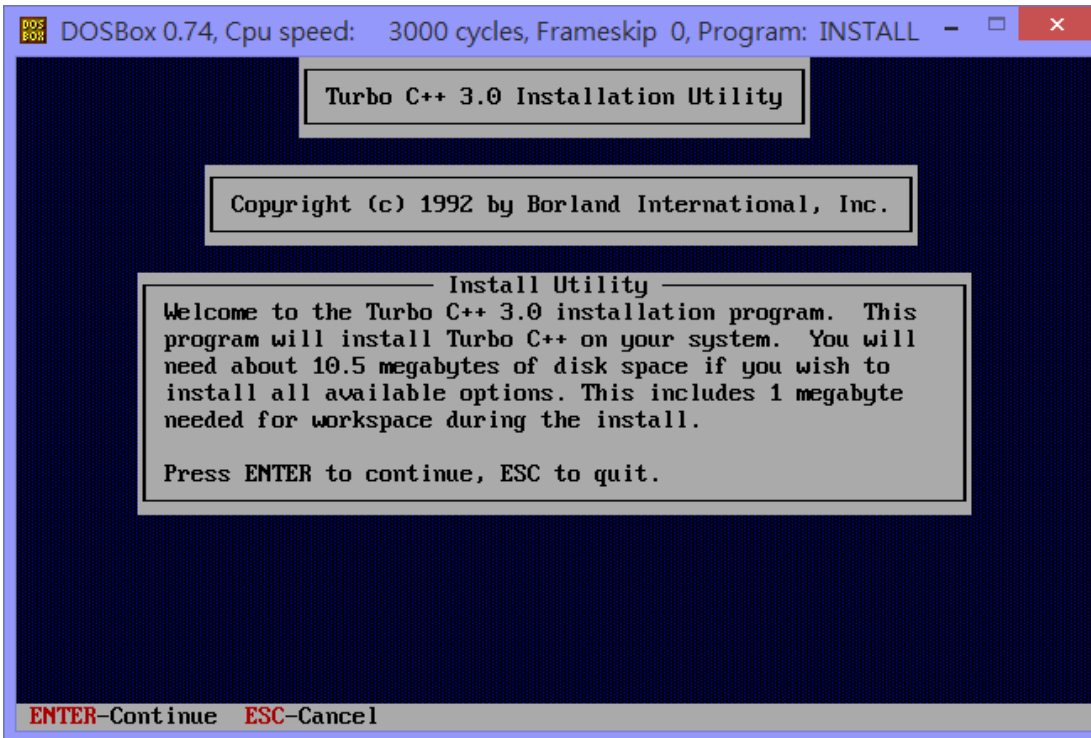

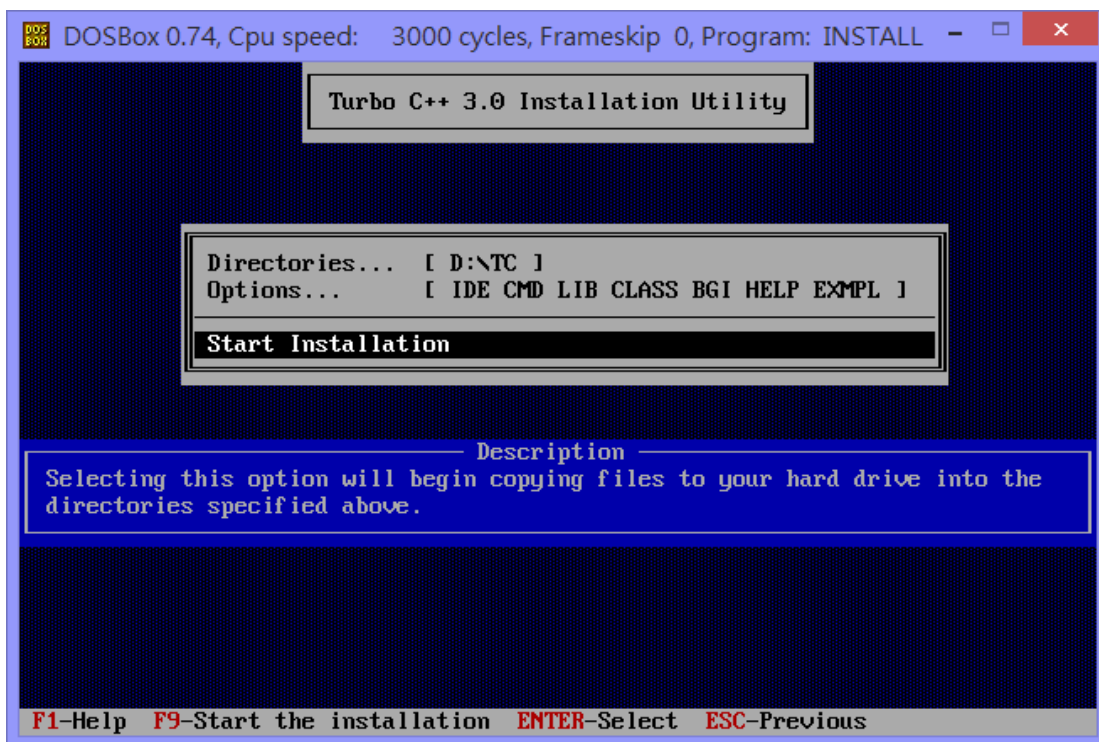
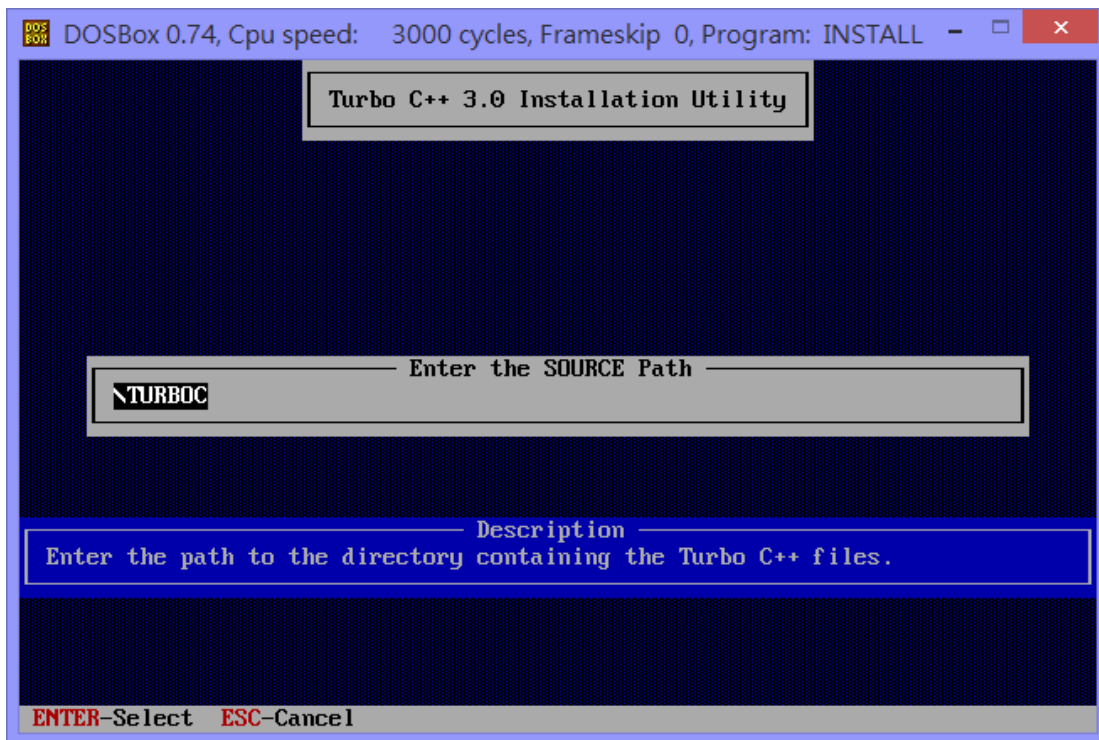

```
DOSBox 0.74, Cpu speed: 3000 cycles, Frameskip 0, Program: README - [ ] [X]
01-07-14 16:26 * D:\TC\README
Welcome to Turbo C++ Version 3.0
-----

This README file contains important information about Turbo C++.
For the latest information about Turbo C++ and its accompanying
programs and manuals, read this file in its entirety.

TABLE OF CONTENTS
-----
1. How to Get Help
2. Installation
3. Features
4. Important Information
5. Testing Your Expanded Memory
6. Corrections to the On-line Help

1. HOW TO GET HELP
-----
If you have any problems, please read this file, the
HELPME!.DOC and other files in your DOC subdirectory, and the
Turbo C++ manuals first. If you still have a question and need
assistance, help is available from the following sources:
Command▶                               Keys:↑↓↔ PgUp PgDn ESC=Exit F1=Help
```

After installed the TC++3.0, then set the Environment Path and change to demo path to run TC compiler IDE.

```
DOSBox 0.74, Cpu speed: 3000 cycles, Frameskip 0, Program: DOSBO... - [ ] [X]
Z:\>mount d d:\
Drive D is mounted as local directory d:\

Z:\>d:
D:\>cd d:\turboc
D:\TURBOC>install.exe
D:\TURBOC>cd ..
D:\>path d:\tc\bin
D:\>cd minios7\hello\hello_c
D:\MINIOS7\HELLO\HELLO_C>tc
```

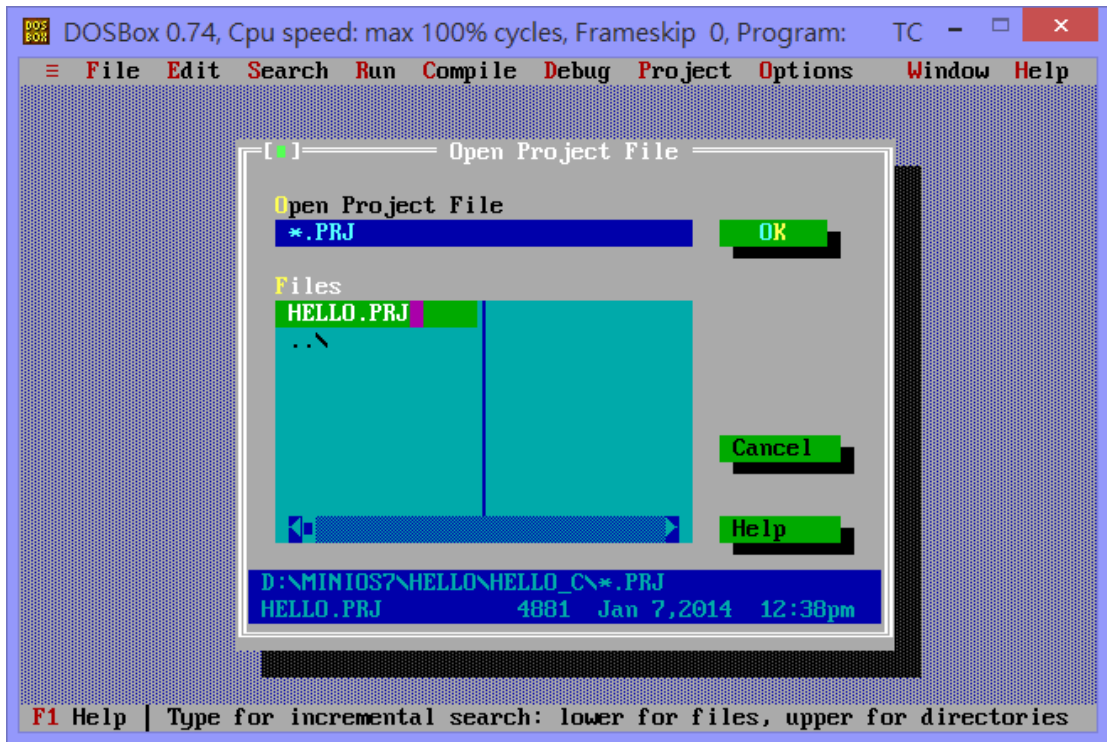

---

# Appendix F: Glossary

## 1. The 64-bit hardware unique serial number:

The I-7188XA(D) is equipped with a 64-bit hardware unique onboard serial number. This number is unique and cannot be shared by any two I-7188XA(D) controllers. The application software can use this number to check the value of the controller and to prevent the use of illegal copies. It is the most low cost protection mechanism the I-7188XA(D) currently has.

## 2. AsicKey:

The I/O expansion bus supports AsicKey. The AsicKey equips a complex machine for validation checking. Included in this are 128 bytes of private data for the same purpose. It provides very strong protection against illegal copies. Every legal user has a unique AsicKey and unique software library, the user can self check this key, or the software library will check the key automatically. In this main, it is nearly impossible to remove the AsicKey protection.

---

# Appendix G: Revision History

Revision	Date	Description
1.0	April 2007	First release
1.1	February 2012	Page 6 1. Modify DI specification. 2. Modify Storage Temperature specification: Original: -40°C to +80°C New: -30°C to +80°C 3. Modify Humidity specification: Original: 0 to 90% New: 10 to 90% RH(non-condensing)
1.2	February 2014	1. Add section 3.4 "Building project on 64-bit platform" 2. Add section "Compiling on 64-bit platform like Windows 7 or Windows 8 / 8.1" in Appendix E: Compiling and linking 3. Add section "Appendix G: Revision History"